

www.ortimplant.com

ORTHOPAEDIC SURGICAL INSTRUMENTS

" We produce for your health... "





"We produce for your health..."

Ortimplant provides a complete platform of trauma & spinal products for upper, lower extremity & spine that covers all the long and small bones injuries for the femur, tibia, fibula clavicle, humerus, radius, ulna, hand & foot bones, spine... etc.

**Plates & Screws
Small Fragment**

DHS - DCS Plates

**Plates & Screw
Mini Fragment**

**Screws & Splints,
Chest Wall Plate**

**Pediatric Plates &
Angled Blade Plates**

● TRAUMA PRODUCTS

We produce superior designed and functional products made off ISO 5832 - 1 Stainless steel and ISO 5832 - 3 Titanium high quality raw materials, suitable with human anatomy and meticulous quality standart

● STERILIZATION CONTAINERS

We produce aluminum sterilization containers suitable for all surgical sets which are convenient, hygienic, safe & which can be used without wrapping with surgical textiles and which can maintain sterilization safety for a long time

● TRAUMA INSTRUMENT SETS

ORTHOPAEDIC surgery instrument sets, including carefully designed aluminum boxes, silicone holders suitable for the placement of the surgical instruments for all ORTHOPAEDIC surgeries, provide great convenience to surgeons during surgery

● STERILIZATION BASKETS

We produce perforated stainless steel baskets suitable for all sets of surgical instruments that can be used in sterilization containers or alone

● ORTHOPAEDIC SURGICAL INSTRUMENTS

We develop and produce ergonomic, convenient and functional, stainless steel ORTHOPAEDIC surgical instruments which increase the success of surgical procedures

● ORTHOPAEDIC STERILIZATION CONTAINERS

Aluminum perforated boxes, screw racks, silicone holders, surgical instrument trays are produced for all surgical instrument sets, which allow the ORTHOPAEDIC surgical instruments to be stored, transported and sterilized by wrapping surgical textile

"With its obsessive Quality policy...."

With its obsessive quality policy and with its open structure to development. Ortimeplant goes on its constitution under today's modern institutional structure

Trochanteric Plates & Cable System

Cannulated Screws

Headless, Herbert Screws

Intramedullary Nails

Elastic Nails

Spinal Systems

External Fixators

Wires, Pins, Staples & Drill Bits

Our expert team has years of experience in development of business and strategy..

From raw materials to services after sales, Ortimeplant considers to apply Total Quality Management System, With respect to this policy Ortimeplant has been certified its Quality with the certificates of CE, ISO 9001 2000, ISO 13485



Percussion Hammers



Spare rubber,
large

Spare rubber,
small

TROEMNER
OSI100135

1/2 245 mm

DEJERINE
OSI100136

1/2 200 mm

DEJERINE
OSI100137

with needle
1/2 210 mm

HURST
OSI100138

Point semi-sharp
1/2 260 mm

TAYLOR
OSI100126

1/2 195 mm

BERLINER
OSI100139

1/2 200 mm

MCGILL
OSI100140

1/2 180 mm

Percussion Hammers

Neurological Hammers



BUCK
OSI100125
mit Nadel und Pinsel
with needle and brush
180 mm

1/2



RABINER
OSI100141
mit Nadel und Pinsel
with needle and brush
255 mm

1/2



BABINSKI
OSI100142
with plastic handle
230 mm

1/3



OSI100143 Rubber ring, diam. 50 mm, for

OSI100144 Rubber ring, diam. 60 mm, for

OSI100145 Rubber ring, diam. 70 mm, for

OSI100146 Plastic handle

NATIONAL HOSPITAL

OSI100147
Ø 50 mm/50 mm diam.

OSI100148
Ø 60 mm/60 mm diam.

OSI100149
Ø 70 mm/70 mm diam.

355 mm

1/4

Aesthesiometers, Stethoscopes

Aesthesiometers



ALY
OSI100150
190 mm

1/2



WARTENBERG
OSI100134
Pinwheel for
neurological
examination
185 mm

1/2



WEBER
OSI100151
Discriminator
90 mm

1/2



SWEET
OSI100152
Discriminator
110 mm

1/2

For fetal heart sounds

Aesthesiometers, Stethoscopes



PINARD
OS1100153
of aluminium
155 mm

1/2



OS1100130
wooden
145 mm

1/2

Tongue Depressors



OS1250764
145 mm



OS1250763
140 mm

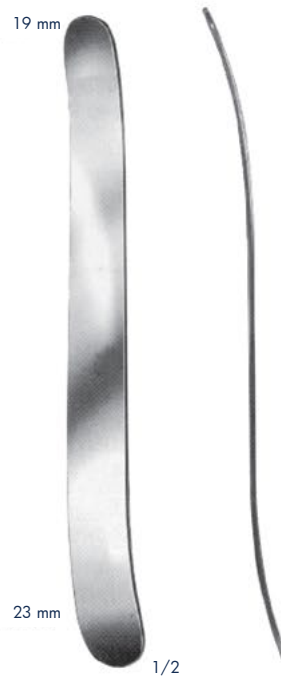

BUCHWALD
OS1250761
180 mm

Tongue Depressors



BRUENINGS
OSI250769
190 mm

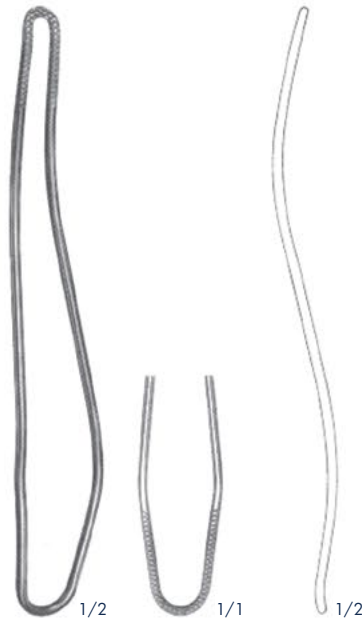

FRENZEL
OSI250772
165 mm

Laryngeal Mirrors

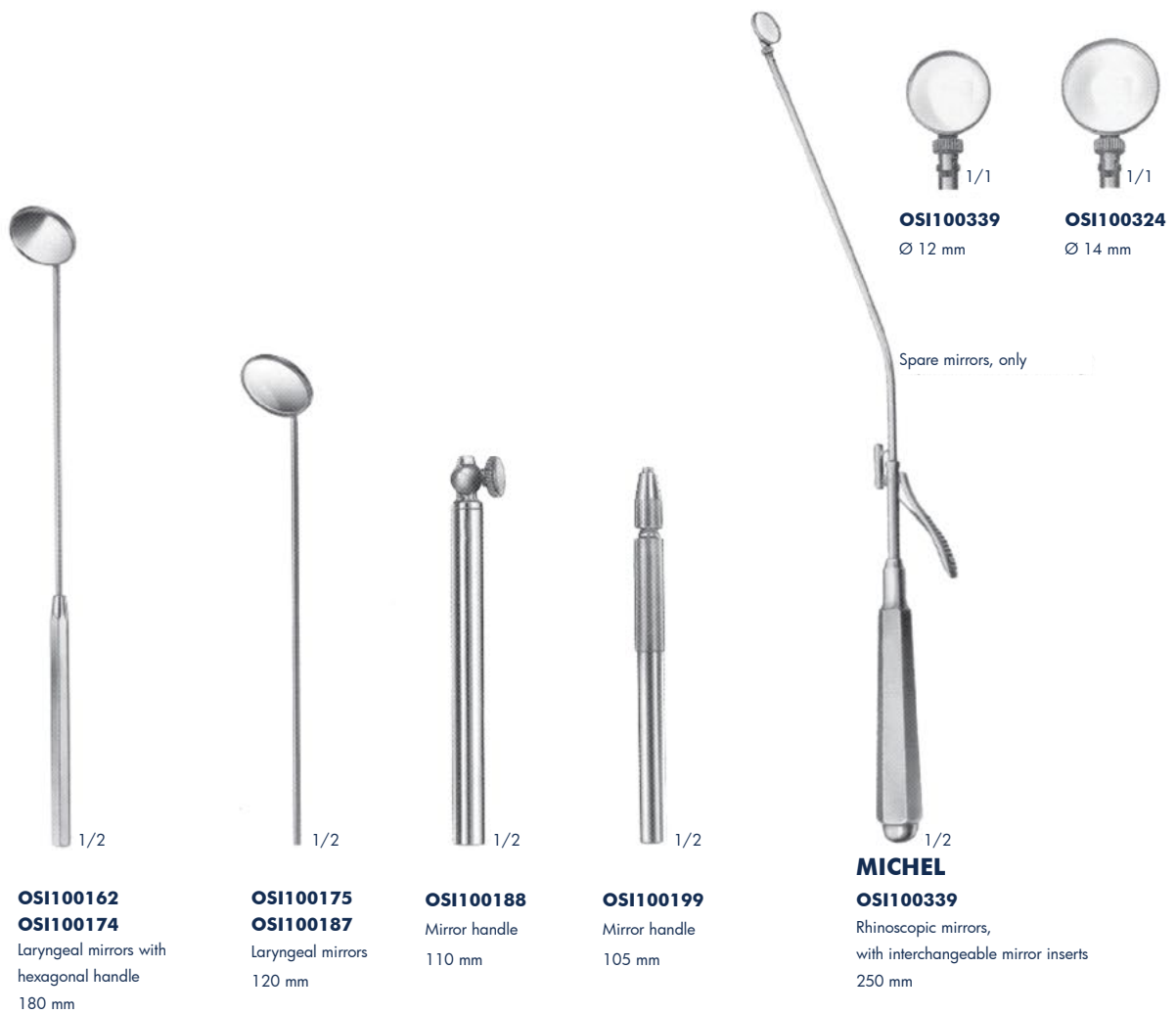

Tuning Forks



HARTMANN

- OSI250260**=c 128
- OSI250261**=c¹ 256
- OSI250262**=c² 512
- OSI250263**=c³ 1024
- OSI250825**=c⁴ 2048
- OSI250826**=c⁵ 4096



OSI250827=a¹ 440

Tuning Forks

Tuning Forks for neurologists



Instruments for Measuring



- OSI100200** Steel ruler, stainless, graduated in millimeters and inches
150 mm (6") long
- OSI100201** idem, 300 m (12") long
- OSI100202** idem, 500 m (20") long

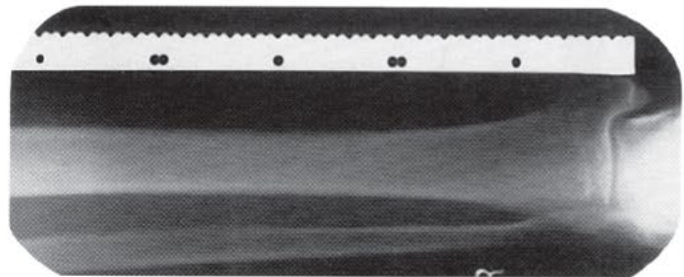

- OSI100203**
Ruler for X-ray work in fracture treatment.
Direct reading. Graduation from half to half cm by distinct notches at the rim. Full cms are Accentuate by deeper notches. Markings of 5 cm and decimeter distance by one and two holes respectively.

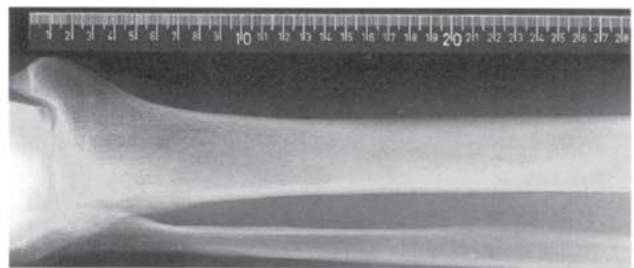

- OSI100204**
Plastic ruler, flexible, for X-ray work.
Can be sterilized in an autoclave at 143°C (3 bar).
Figures and mm-graduation transparent to X-ray.



- 1,5 m **OSI100205**
- 2,0 m **OSI100206**
- 1,5 m **OSI100207**

- OSI100205** Steel tape measure 1,5 m, graduated in millimeters and inches
- OSI100206** idem, 2 m long
- OSI100207** Tape measure of oilcloth 1,5 m, graduated in millimeters and inches

Instruments for Measuring



OSI100208
Special caliper
for neuro-surgery
125 mm



OSI100127
Caliper,
measuring range up to 150 mm
230 mm



OSI100210
Caliper,
measuring range up to 100 mm
130 mm



CASTROVIEJO
OSI100211
Caliper
75 mm



OSI100212
Caliper,
measuring range 150 mm
140 mm



OSI100213
Finger goniometer
125 mm



MÖLTGEN
OSI100214
Goniometer

Instruments for Measuring



BERTILLON

OSI100215

Caliper,
for measuring the head
320 mm



THÖLE

OSI100216

Goniometer,
for measuring angles,
diameters and body cavities
340 mm

Instruments for Measuring



Pressure
72 kg

COLLIN

OSI100359

Dynamometer for adults
125 mm



OSI100217

Metal ink pot



OSI100218

Ø 33 mm



OSI100219

Ø 38 mm

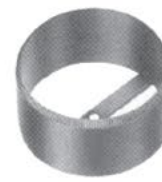

OSI100220

Ø 42 mm



OSI100221

Ø 48 mm

Mamille marker, toothed

Preparation - Dressing Forceps



GROSS
OSI140109 - OSI140113
Dressing forceps
200 mm

OSI140101 - OSI140104
Dressing forceps
220 mm

Preparation - Nail Scissors



OS1110466
Nail scissors
90 mm



OS1110467
Nail scissors
especially fine pattern
90 mm



OS1110468
Baby nail scissors
85 mm



Nail scissors

OS1110469 90 mm
OS1110470 90 mm
OS1110471 100 mm
OS1110472 110 mm



Nail scissors

OS1110473 95 mm
OS1110474 95 mm
OS1110475 105 mm

Preparation - Nail Scissors, Nail Cutters



OS1110339 - OS1110341

Nail scissors
95 mm

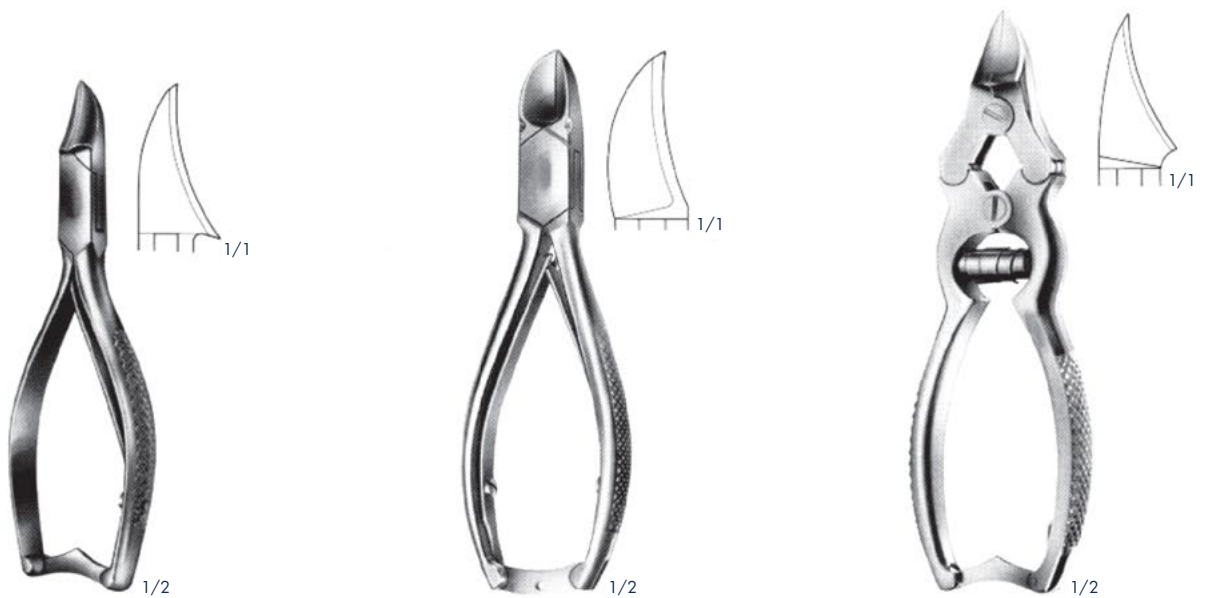

OS1110476

Nail cutters
135 mm

OS1110478

Nail cutters
145 mm

OS1110479

Nail cutters
155 mm

Instruments for Anaesthesia



1/2

OSI100364

Mouth gag wooden
140 mm



1/1

SCHMID

OSI260449

Mouth gag, infinitely adjustable
by thread, with 1 moveable part



1/2

HEISTER
OSI100222

Mouth gag
130 mm



1/2

FERGUSON-ACKLAND
OSI100223

Mouth gag
145 mm

Instruments for Anaesthesia



DENHARDT
OSI250704

Mouth gag, with silicone inserts, interchangeable
125 mm



FEATHERSTONE
OSI100224

Mouth gag
165 mm



ROSER-KÖNIG
OSI100225

Mouth gag
160 mm



ROSER-KÖNIG
OSI100226

Mouth gag
185 mm

Tongue Forceps



YOUNG
OSI250775
165 mm



COLLIN
OSI130130 170 mm
OSI130448 160 mm



HEYWOOD-SMITH
OSI230232
200 mm



HEYWOOD-SMITH MODIF.
OSI230233
215 mm

Laryngoscopes



MAGILL

- OSI100227** 150 mm for infants
 - OSI100132** 200 mm for children
 - OSI100133** 250 mm for adults
- Catheter introducing forceps

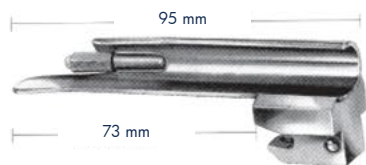

OSI100365

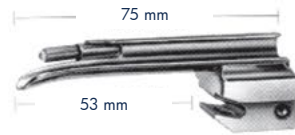

OSI100366

Blade for premature babies

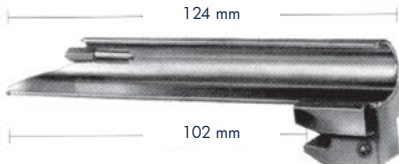

OSI100367

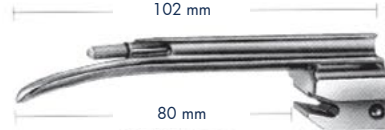

OSI100368

small blade

NEGUS

BABY-MILLER



Spare bulb, 2.5 volt,



Spare bulb, 2.5 volt,

Preparation and other Instruments



PEAN

OSI130449

Tubing clamp forceps
125 mm



MOD. KLINIKUM BERLIN

OSI130450

Tubing clamp forceps
heavy pattern, long ratchet,
therefore passage adjustable
145 mm



OSI130451

Tubing clamp forceps
especially heavy pattern,
smooth jaws
165 mm



OSI130452

Tubing clamp forceps
especially heavy pattern,
serrated jaws
165 mm

Preparation and other Instruments



OSI130364
Tubing clamp
180 mm



OSI130367
Tubing clamp
180 mm



OSI130365
Tubing clamp
heavy wedge jaw
200 mm



SAUERBRUCH
OSI130567
Operating Room
Pick-up forceps for
used tampons and
dressings
550 mm

Razor Blade Breakers and - Holders



OSI100228
Razor blade breaker
and -holder, straight
185 mm



* To open push back
the jacket



1 side convex

OSI100113
Razor blade breaker
and -holder, straight
120 mm

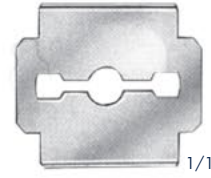

OSI100371
Razor blades

Sales unit:
PZ = Package
of 10 pieces



Diamond powder
coated, thus firm
grasping of the
blade

OSI100230
Razor blade breaker
and holder
150 mm

Scalpels



OSI100231 OSI100232 1/1

GRAEFE
OSI100231 - OSI100232
130 mm



OSI100233 OSI100234 OSI100235 1/1

OSI100236 OSI100237 OSI100238 1/1

OSI100233 - OSI100238
130 mm

Scalpels, Tenotomes



OSI100239 1/1

OSI100240 1/1

BERGMANN
OSI100239 - OSI100240
140 mm



OSI100241 1/1

OSI100242 1/1

OSI100241 - OSI100242
135 mm



OSI100243 1/1

OSI100244 1/1

DIEFFENBACH
OSI100243 - OSI100244
160 mm

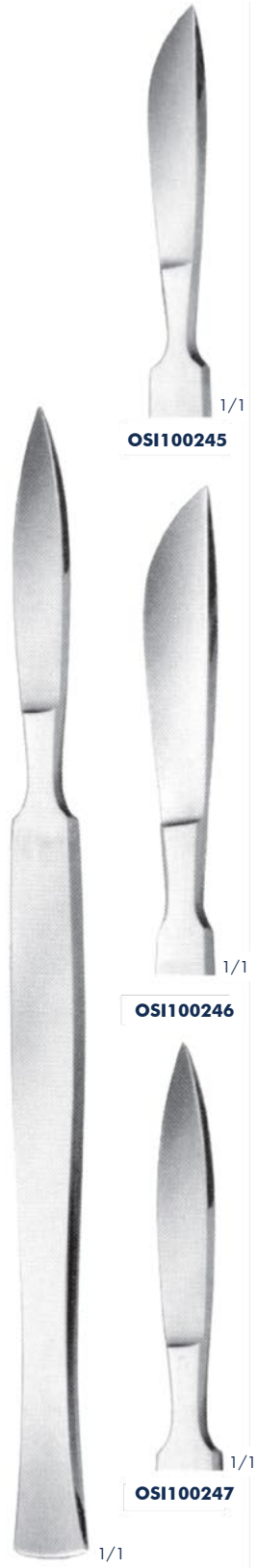

OSI100245 1/1

OSI100246 1/1

OSI100247 1/1

OSI100245 - OSI100247
160 mm

Scalpels, Tenotomes

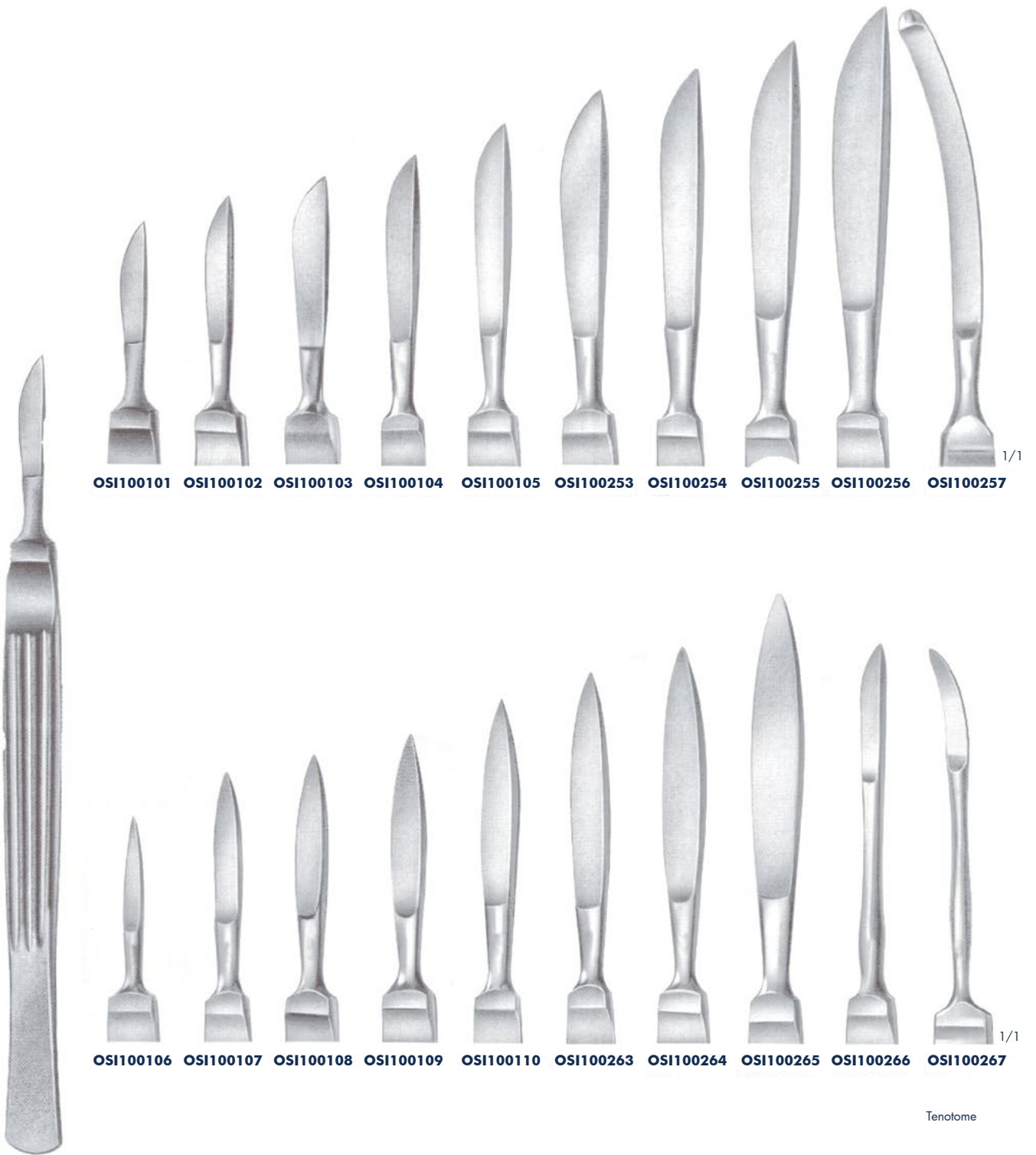

OSI100101 OSI100102 OSI100103 OSI100104 OSI100105 OSI100253 OSI100254 OSI100255 OSI100256 OSI100257 1/1

OSI100106 OSI100107 OSI100108 OSI100109 OSI100110 OSI100263 OSI100264 OSI100265 OSI100266 OSI100267 1/1

Tenotome

OSI100101 - OSI100267
140 mm - 175 mm

Amputation Knives



LISTON

- OSI100268** 130 mm
 - OSI100269** 160 mm
 - OSI100270** 190 mm
 - OSI100271** 220 mm
- Length of blade

Amputation knives



double cutting

1/2

CATLIN

- OSI100272** 160 mm
- Length of blade
- Amputation knife



1/2

LANGENBECK

- OSI100273** 120 mm
- Length of blade
- Flap knife

Amputation - and Resection Knives

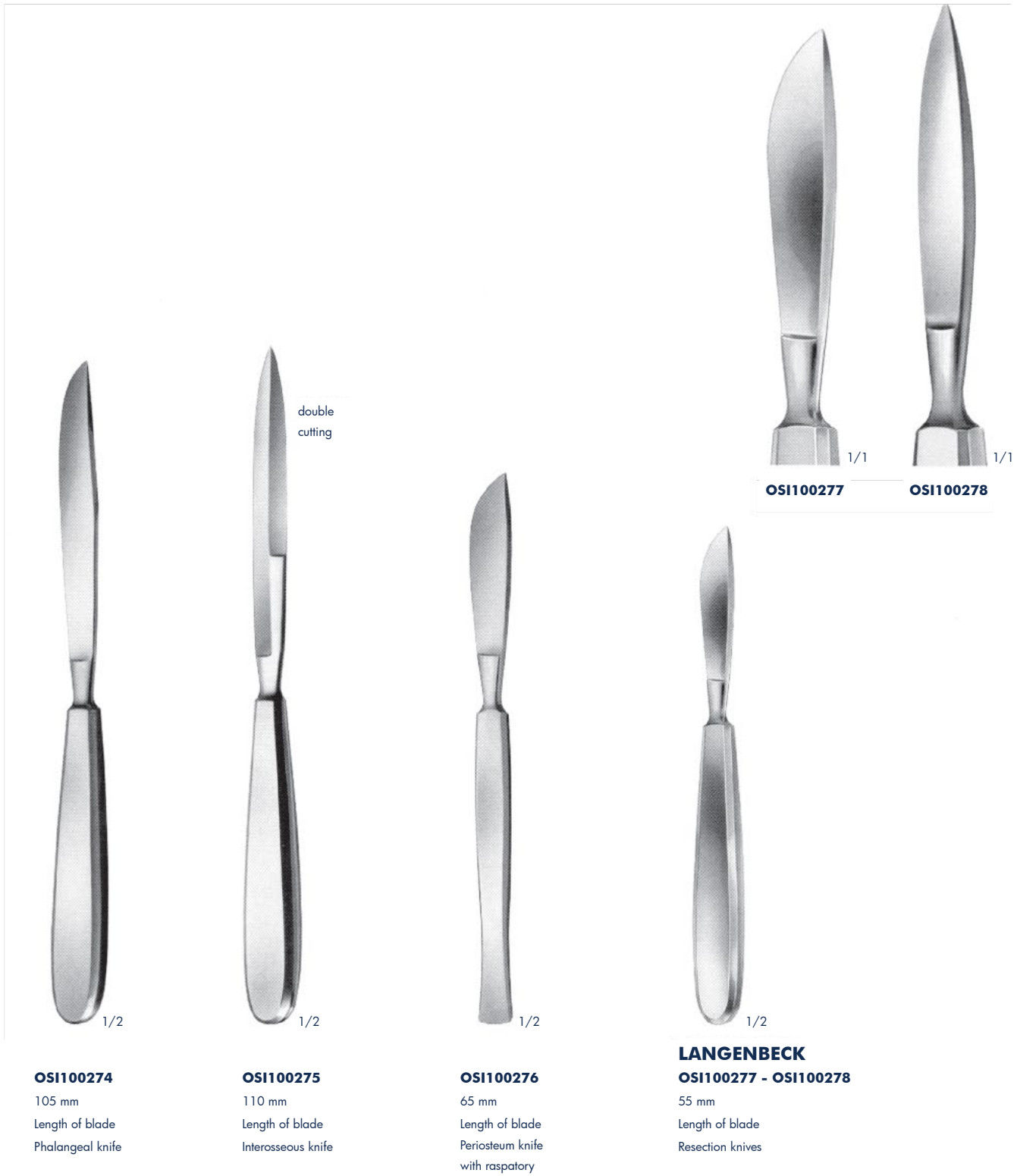

OSI100274
105 mm
Length of blade
Phalangeal knife

OSI100275
110 mm
Length of blade
Interosseous knife

OSI100276
65 mm
Length of blade
Periosteum knife
with raspator

LANGENBECK
OSI100277 - OSI100278
55 mm
Length of blade
Resection knives

Cartilage Knives



1/2

OSI100279
55 mm
Length of blade
with raspatory,
wooden handle



1/2

OSI100280
55 mm
Length of blade
Metal handle



1/2

OSI100281
70 mm
Length of blade
Wooden handle

Autopsy Knives



1/2

VIRCHOW
OSI100282
85 mm
Length of blade
Metal handle



1/2

VIRCHOW
OSI100283
95 mm
Length of blade
Wooden handle



1/2

OSI100284
115 mm
Length of blade
Wooden handle

Autopsy Knives, Throat Knives



OS1100285
80 mm
Length of blade
Metal handle



OS1100286
130 mm
Length of blade
Metal handle



OS1100287
195 mm
Length of blade
Metal handle



OS1100288
100 mm
Length of blade
Metal handle

Autopsy Knives, Brain Knives



1/2

OS1100289
110 mm
Length of blade
Wooden handle



1/2

OS1100111
170 mm
Length of blade
Wooden handle



1/2

VIRCHOW
OS1100290
160 mm
Length of blade
Metal handle



1/2

VIRCHOW
OS1100291
200 mm
Length of blade
Metal handle



1/2

VIRCHOW
OS1100292
240 mm
Length of blade
Metal handle

Fistula Knives, Cone Knives and Myomatom



SIMON
OSI100248 - OSI100250
 Fistula knives
 200 mm

ULRICH
OSI100372
 Fistula knife
 225 mm

AYRE
OSI100251
 Cone knife
 235 mm

OSI100252
 Cone knife
 230 mm

SEGOND
OSI100258
 Myomatome
 270 mm

Trigeminal - and Tonsil Knives



OLIVECRONA
OSI100259
Trigeminal knife
205 mm

OSI100260
Trigeminal knife
230 mm

FOWLER
OSI100261
Tonsil knife
200 mm

ABRAHAM
OSI260106
Tonsil knife
215 mm

BRÜNINGS
OSI260107
Tonsil knife
215 mm

Scalpels



1/1

MOSING

OSI260400

Cartilage slitting knife,
curved blade, pointed
130 mm



1/1

OSI100262

Abscess knife,
130 mm



1/1

JOSEPH

OSI250505 straight

OSI250504 curved

Double-edged nasal knives, pointed
145 mm



1/1

OSI250505



1/1

OSI250504



1/1

Dura Knives

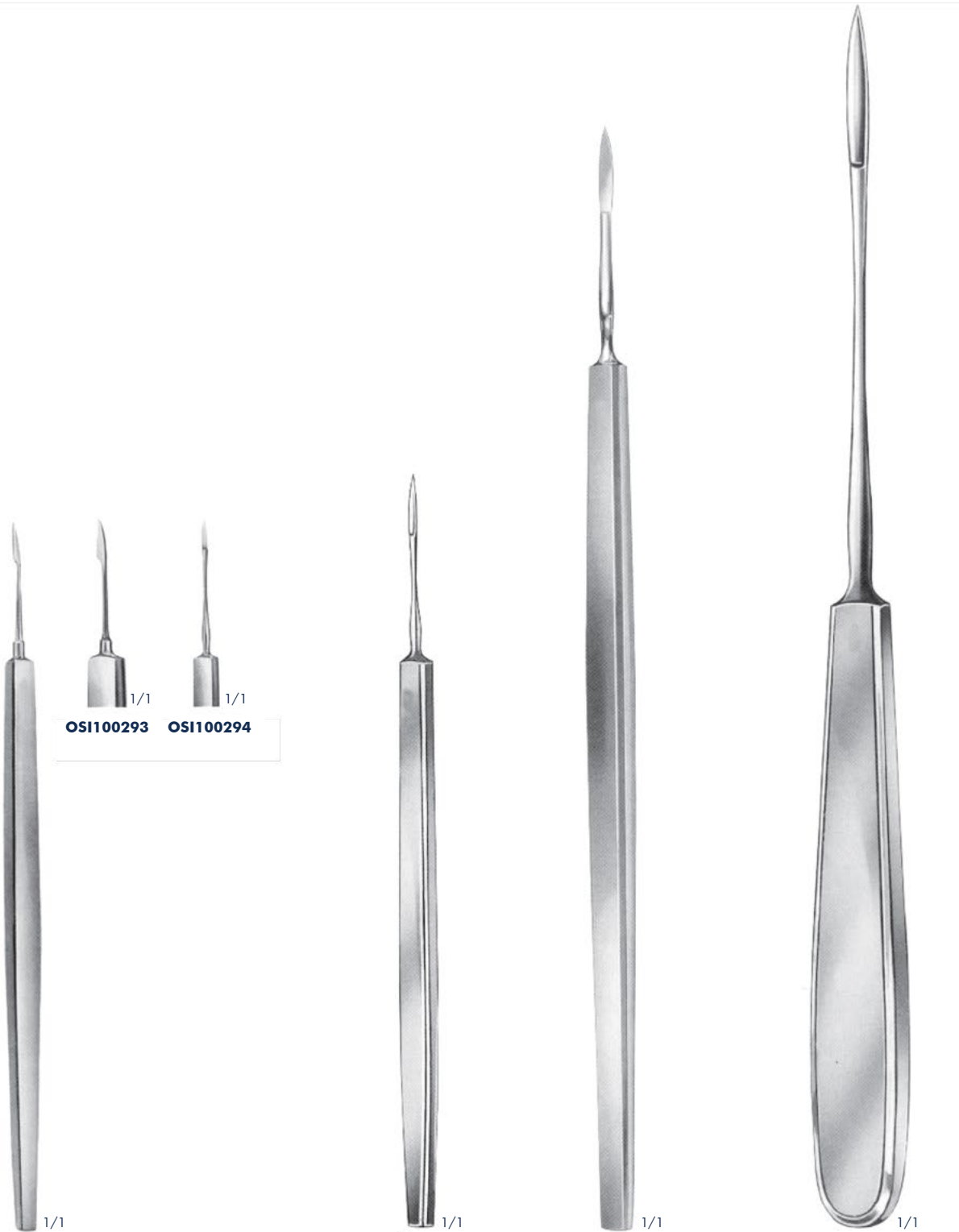

ZIEGLER
OS1100293 small
OS1100294 pointed
Milium knives
120 mm

TÖNNIS
OS1100295
Dura knife
130 mm

TÖNNIS
OS1100296
Dura knife
190 mm

HALLE
OS1100297
Dura knife
210 mm

Knife Racks - Sterilizing Racks - Comedone Extractors



OSI100373
for 6 scalpels



OSI100374
for interchangeable scalpel handles with blade

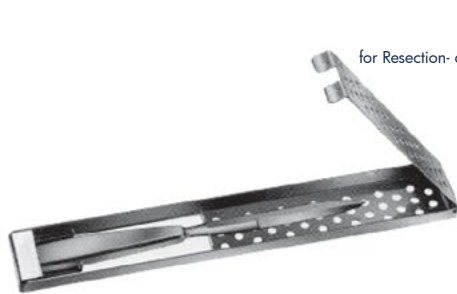

for Resection- and Amputation knives



OSI100375
Sterilizing Rack for 1 knife
with length of blade up to 140 mm
290 x 40 x 14 mm

OSI100376
Sterilizing Rack for 2 knife
with length of blade up to 190 mm
335 x 65 x 14 mm

Comedone Extractors



VIDAL
OSI220138
Lupus scraper
135 mm



MONCORPS
OSI220137
Blade only
Milium knife
130 mm



SAALFELD
OSI100209
100 mm

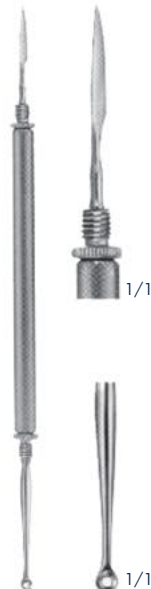

HEBRA
OSI100229
180 mm



OSI100377
145 mm



UNNA
OSI100298
140 mm

Dermal Punches



KEYES
OSI100299 - OSI100304
 Dermal punches
 100 mm



KEYES MODIF.
OSI100305
 Dermal punch, complete with 6 interchangeable tips
 handle and Rack

OSI100306
 Handle, only for



- OSI100308** Ø 2,5 mm
- OSI100309** Ø 3,0 mm
- OSI100310** Ø 3,5 mm
- OSI100311** Ø 4,0 mm
- OSI100312** Ø 6,0 mm
- OSI100313** Ø 10,0 mm

Dermal punches, with quickAction (Dental) shaft



OSI100307

Skin Grafting Knives



REHN
OSI100314
235 mm

1/2



GOULIAN
OSI100315

Dermatome with 3 grafting templates 0.20, 0.25 and 0.30 mm thick, complete with 5 blades
180 mm

1/2

OSI100316

Spare blades

Sales unit:
PA = Package of 50 pieces



Maximal width of skin graft: 100 mm

SCHINK

OSI100129
Dermatome, adjustable from 0.1 to 2.0 mm, complete, with 1 interchangeable blade and 2 skin straightening plates
300 mm

1/3



OSI100317

Spare blade only



OSI100318

Skin straightening plate only

Skin Grafting Knives

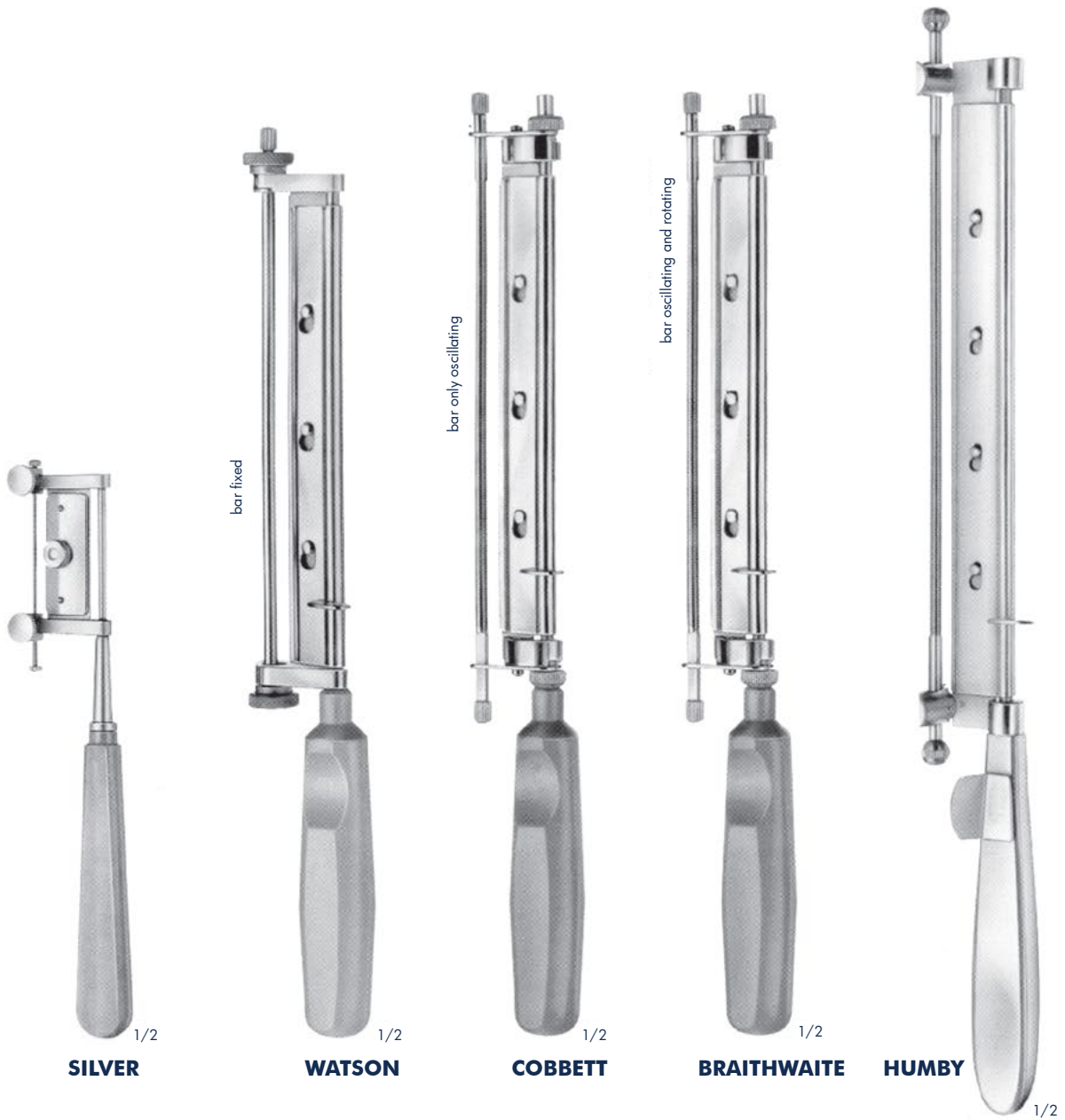

SILVER 1/2

OSI100319
Skin graft knife,
without blade
190 mm

OSI100320
Spare blade,
non sterile
Sales unit:
PZ = Package of
10 pieces

bar fixed

WATSON 1/2

OSI100321
Skin graft knife,
without blade
300 mm

OSI100322
Spare blade,
sterile
Sales unit:
PZ = Package of
10 pieces

bar only oscillating

COBBETT 1/2

OSI100323
Skin graft knife,
without blade
315 mm

bar oscillating and rotating

BRAITHWAITE 1/2

OSI100325
Skin graft knife,
without blade
315 mm

HUMBY 1/2

OSI100327
Skin graft knife,
without blade
365 mm

OSI100328
Spare blade,
sterile
Sales unit:
PZ = Package of
10 pieces

Scalpel Handles

For blades fig. 10 - 15 and fig. 40, 42



BARRON
OSI100329



OSI100121
No. 3



OSI100123
No. 3 L

Corresponds
with english
No.5



OSI100120
No. 7

Scalpel Handles

For blades fig. 10 - 15 and fig. 40,42



OSI100119 1/1

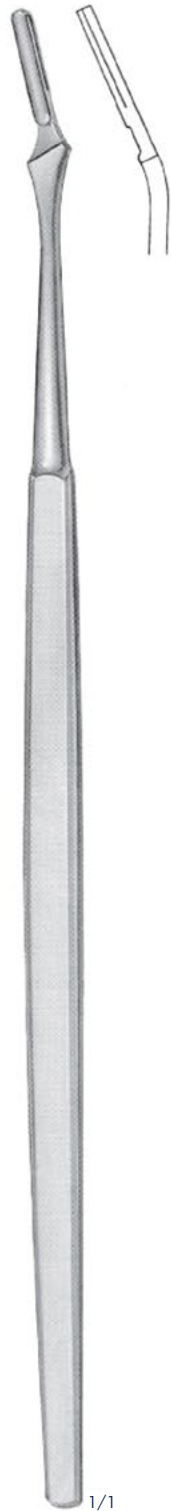

OSI100330 1/1



OSI100331 1/1



OSI100332 1/1

Scalpel Handles



OSI100114
No. 4

OSI100115
No. 4 L

OSI100350

OSI100117
No. 8

OSI100118

Scalpel Handles for Microsurgery Blades



OSI100333
Scalpel handle,
round
135 mm



OSI100334
Scalpel handle,
round
155 mm



CASPAR
OSI100335
Scalpel handle,
round
180 mm



OSI100336
Scalpel handle,
round
200 mm



OSI100337
Scalpel handle,
round
330 mm

Scalpel Handles for Microsurgery Blades

Microsurgery Blades

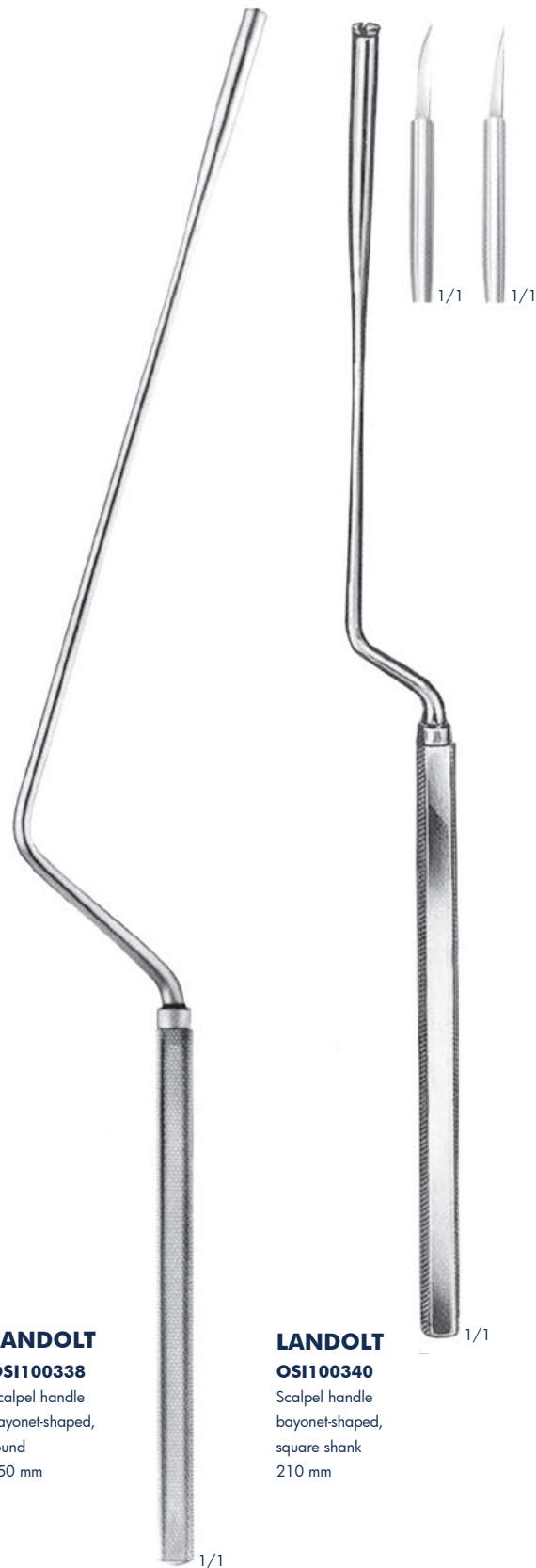

LANDOLT

OSI100338

Scalpel handle
bayonet-shaped,
round
250 mm

LANDOLT

OSI100340

Scalpel handle
bayonet-shaped,
square shank
210 mm

Micro Scissors (Spring Type) with flat handles



VANNAS
OSI110480 - OSI110482
85 mm



MC CLURE
OSI110483
95 mm



CASTROVIEJO
OSI110484 - OSI110485
95 mm

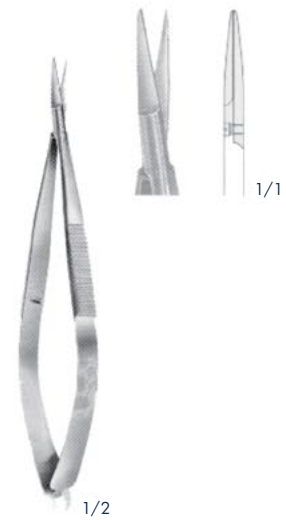

NOYES
OSI110486
125 mm

Micro Scissors (Spring Type) with flat handles



OSI110487 - OSI110488
105 mm



WECKER
OSI110489 - OSI110490
Eye scissors
110 mm

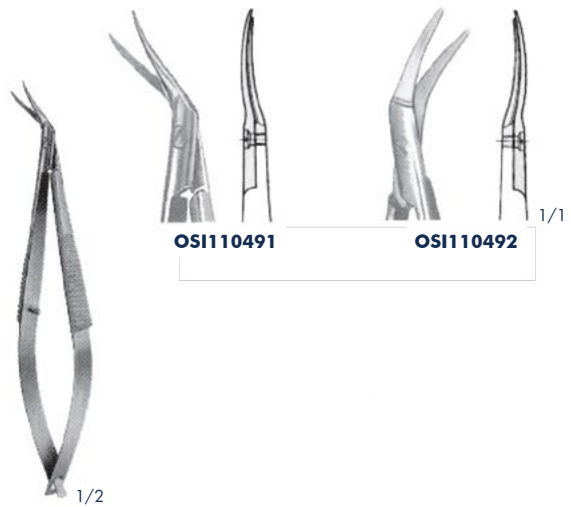

CASTROVIEJO
OSI110491 - OSI110492
Eye scissors
110 mm

Micro Scissors (Spring Type) with flat handles and cross - serration



... with flat handles and cross-serration
Flat handles, sure grip due to cross-serration



120 mm

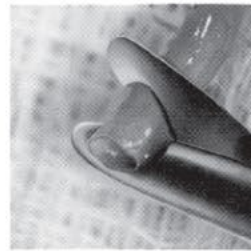

Vein Scissors
for roughening vessel ends
● Vessel cannot slip off
● clean, smooth cut

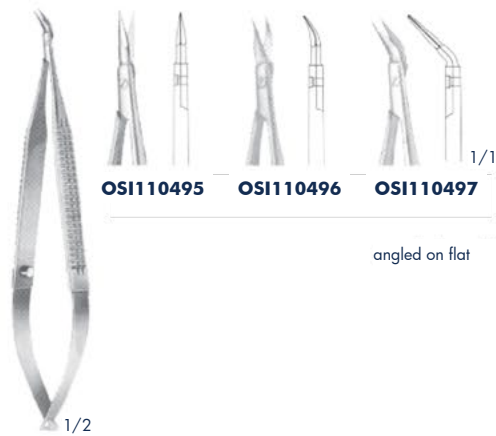

angled on flat

VANNAS

120 mm



BIEMER

Vein scissors

130 mm

Micro Scissors (Spring Type) with flat handles and cross - serration

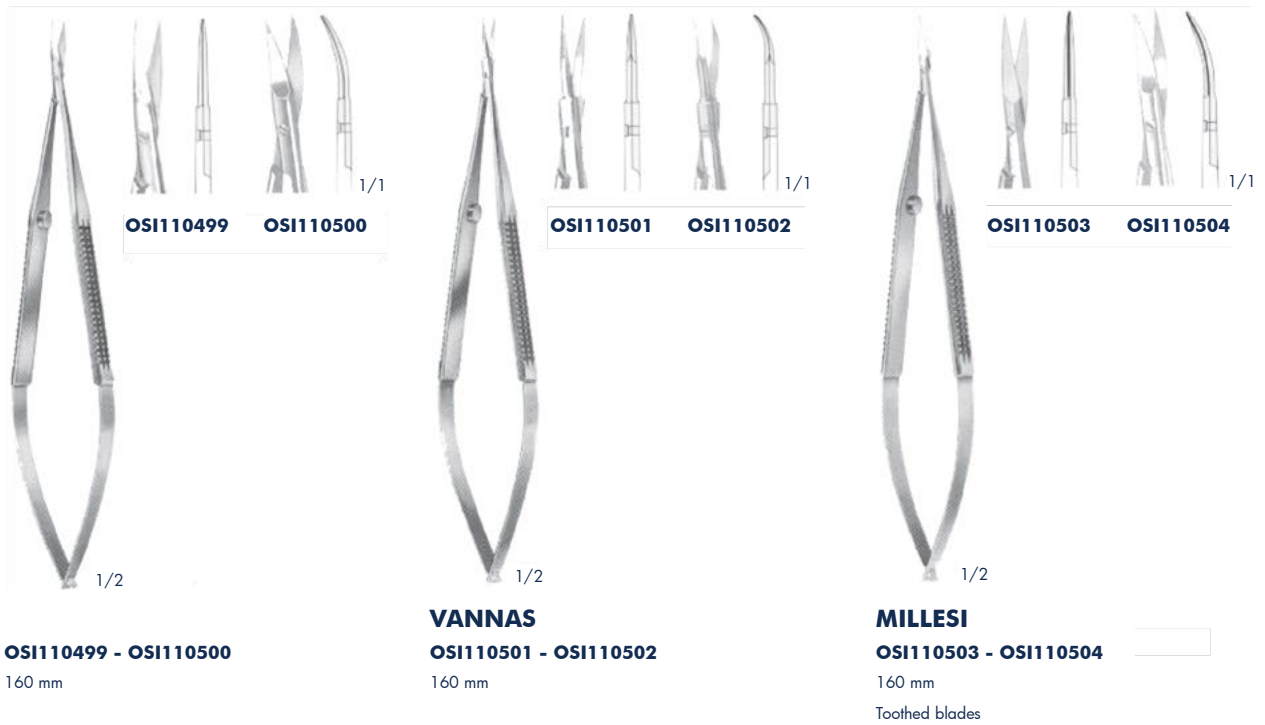

Micro Scissors (Spring Type), Micro Scissors

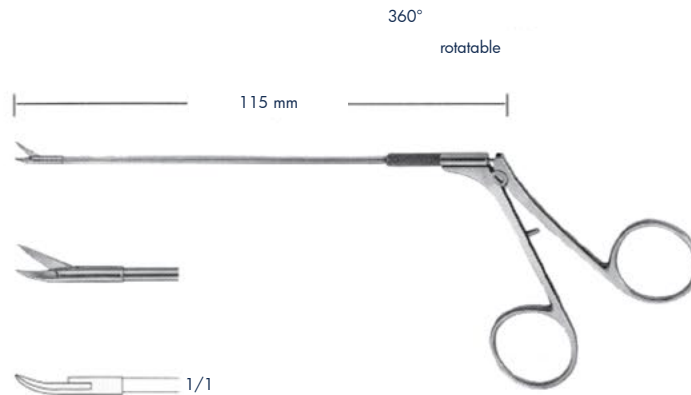

CASPAR
OSI110767
Micro Scissors, curved

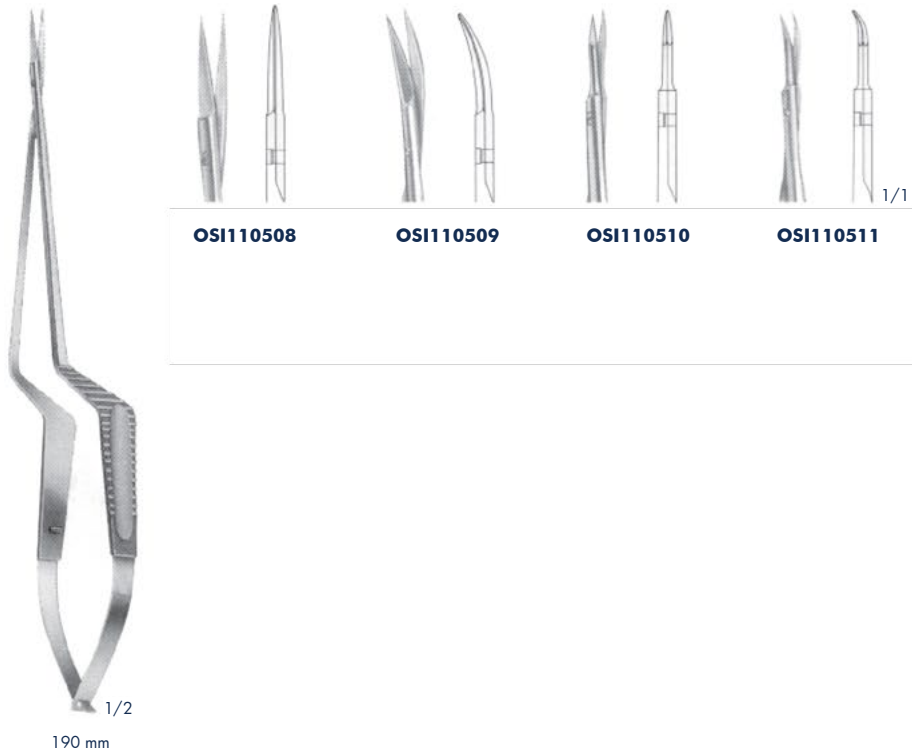

OSI110508

OSI110509

OSI110510

OSI110511

Micro Scissors (Spring Type) with round handles

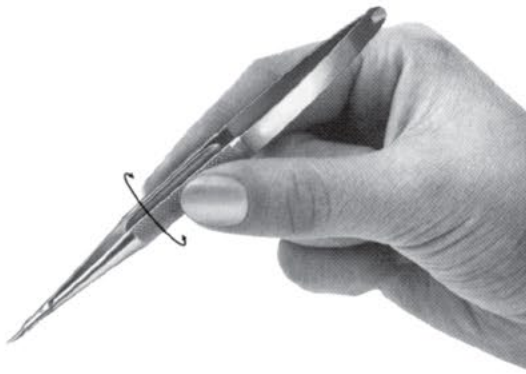

... with round handles

Round handles allow turning manipulations between the fingers.

Optimum balance individually for each instrument due to solid or hollowed-out handles.



1/2

OSI110512 - OSI 110514

145 mm



OSI110512



OSI110513

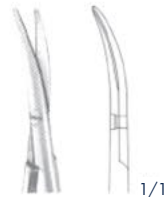

1/1

OSI110514

Micro dissecting scissors

Micro Scissors (Spring Type) with light plastic handle

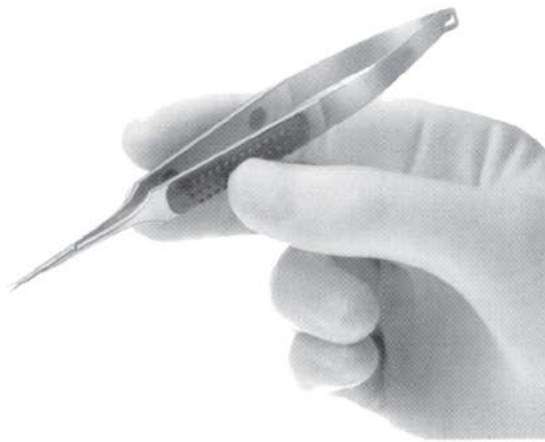

- micro instruments with new, light plastic profile
- The new, light plastic profile increases the grip surface, thus guaranteeing an uncramped hand position and providing enhanced sensitivity.
 - The round grip cross-section permits easy and uniform turning of the instrument. This extends the application and working areas.
 - The easy-grip studded profile guarantees a secure hold for all movements.
 - Development in Accordance with ergonomic criteria and the low weight of the new plastic grips are factors which create the preconditions for fatigue-free working and optimum handling.



OSI110515
sharp/sharp

OSI110516
sharp/sharp

OSI110517
sharp/blunt

OSI110518
blunt/blunt

OSI110519
ball pointed/sharp

MÜLLER
OSI110515 - OSI110519
Handle colour: blue
120 mm



OSI110520
sharp/sharp

OSI110521
sharp/sharp

MÜLLER
OSI110520 - OSI110521
Handle colour: blue
170 mm

Micro Scissors (Spring Type) bayonet - shaped



... with YASARGIL Profile Handles

- According to the length of the instrument there are several bore holes which ensure an equally safe grip in the front, middle or rear part of the handle and compared with former patterns the instrument is much more balanced.
- Differing from former patterns, instruments with short working ends have now longer handles and springs thus guaranteeing the best hold.
- The bore holes in the handles allow reliable gripping and holding of the instrument which is of importance for deep surger.
- Reduction of weight due to the bore holes.



YASARGIL
OSI110522 - OSI110523
165 mm



YASARGIL
OSI110524 - OSI110526
200 mm

Micro Scissors (Spring Type) bayonet - shaped



YASARGIL
OSI110527 - OSI110531
225 mm



OSI110527

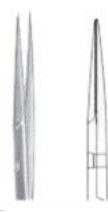

OSI110528



OSI110529



OSI110530



OSI110531

1/1

toothed

Micro Scissors (Spring Type) bayonet - shaped



Micro Dissecting Scissors (Spring Type) bayonet - shaped

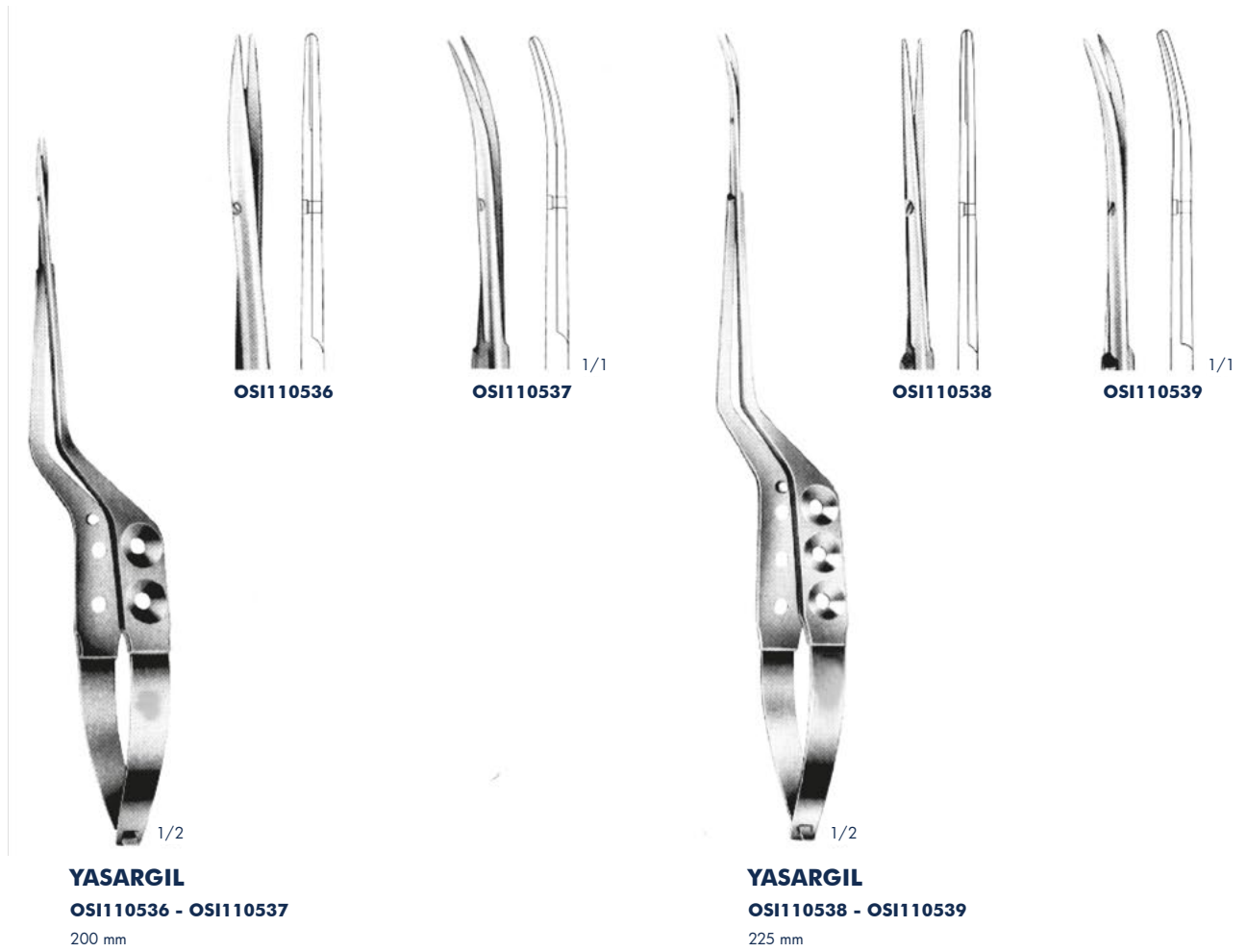

Delicate Scissors - large ring design



OSI110540

OSI110541

OSI110540 - OSI110541

115 mm



OSI110542

OSI110543

OSI110542 - OSI110543

120 mm



OSI110273

OSI110274

JOSEPH

OSI110273 - OSI110274

150 mm

Delicate Scissors - large ring design



OSI110279

sharp

OSI110281

sharp

OSI110280

blunt

OSI110282

blunt

STEVENS

OSI110279 - OSI110282

Dissecting scissors

115 mm



OSI110277

OSI110278

OSI110191

OSI110192

OSI110277 - OSI110278

Dissecting- and strabismus scissors

115 mm

METZENBAUM

OSI110191 - OSI110192

Dissecting scissors

145 mm

Delicate Scissors - large ring design



OSI110554

REYNOLDS-JAMESON

OSI110554

Vessel scissors
140 mm



OSI110555

OSI110555

Nerve dissecting scissors,
blades outside semi-sharp
140 mm



RAGNELL
OSI110556

135 mm

RAGNELL
OSI110557

135 mm

OSI110558

150 mm

OSI110556 - OSI110558

Special flat points for dissecting
and undermining the skin

Delicate Scissors



OSI110344

OSI110560

OSI110344 - OSI110560
90 mm



OSI110339

OSI110341

OSI110339 - OSI110341
95 mm



OSI110563

OSI110564

105 mm



OSI110335

OSI110336

OSI110335 - OSI110336
120 mm

Delicate Scissors

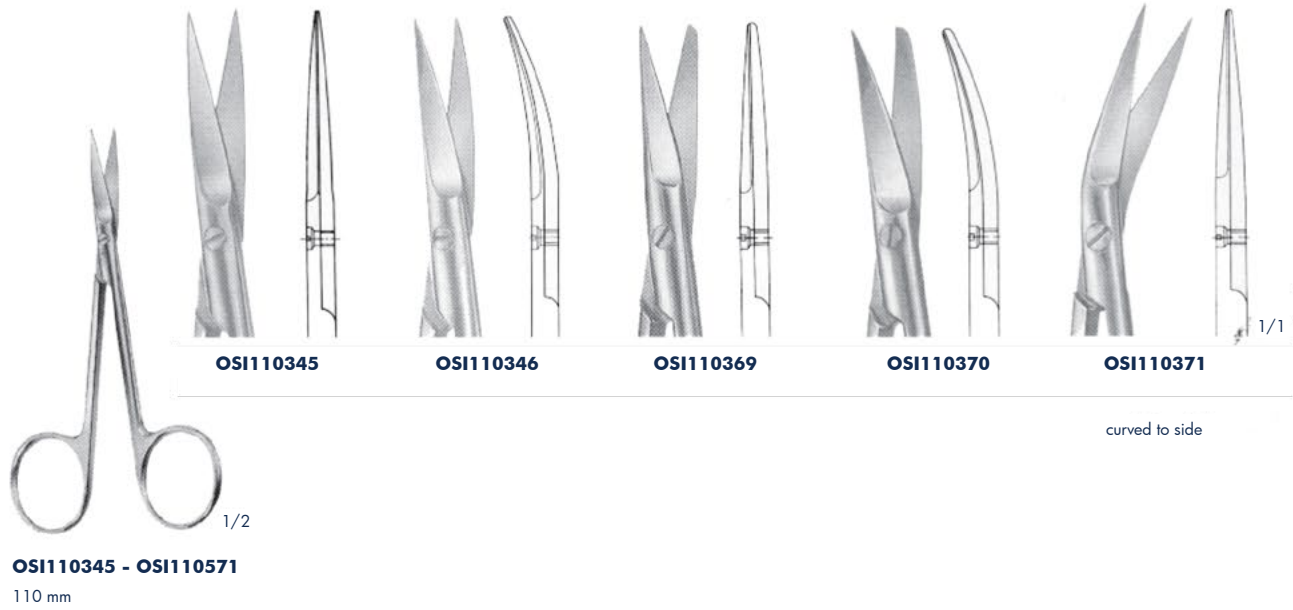

Delicate Scissors



1/2

OSI110576 - OSI110578

120 mm

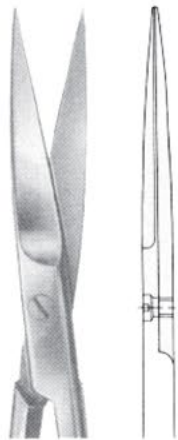

OSI110576



OSI110577

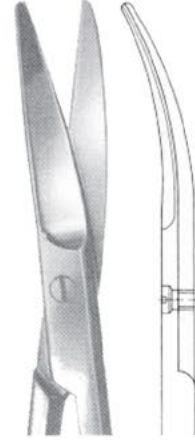

1/1

OSI110578



1/2

OSI110579 - OSI110582

120 mm

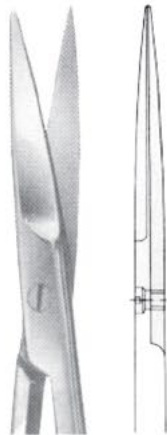

OSI110579

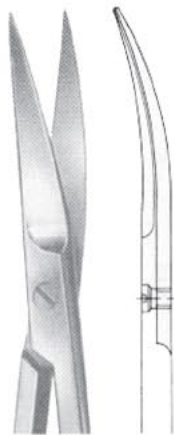

OSI110580

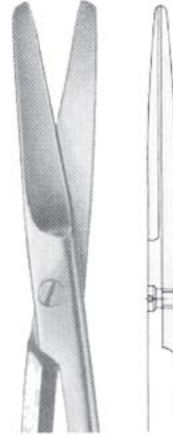

OSI110581

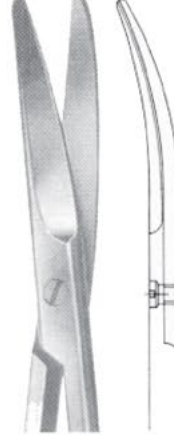

1/1

OSI110582

Delicate Scissors



CHADWICK
OSI110583
115 mm



QUINBY
OSI110325
130 mm



OSI110355
110 mm

Delicate Scissors



PERWITSCHKY

OSI110586

Salival scissors, curved to side
100 mm



OSI110587

angled to side
115 mm

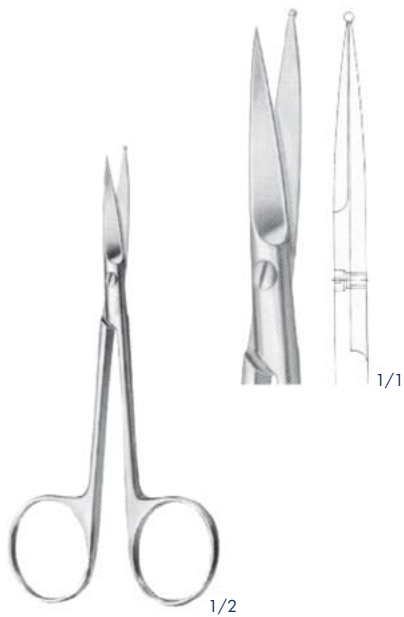

OSI110298

with 1 probe-pointed blade
120 mm



OSI110589

with 1 probe-pointed blade
145 mm

Delicate Scissors



LA GRANGE

OSI110590
1 blade toothed
110 mm



OSI110591

1 blade toothed,
angled on flat
125 mm



OSI110592

1 fine toothed blade
130 mm



LOCKLIN

OSI110593

angled to side, 1 toothed blade
155 mm

Delicate Scissors



JOSEPH
OS1110594 - OS1110595
150 mm



KELLY
OS1110184 - OS1110186
175 mm

Surgical Scissors

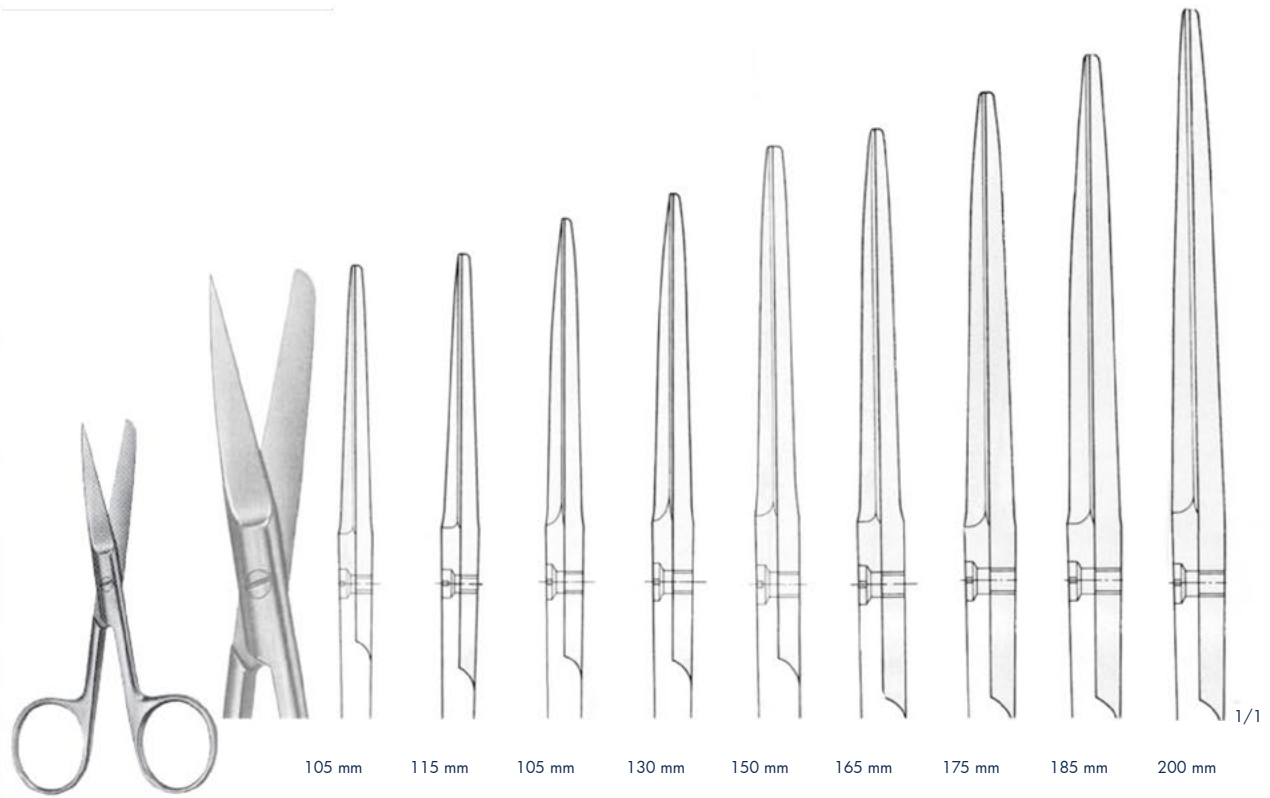

OSI110109 - OSI110116

Standard patterns

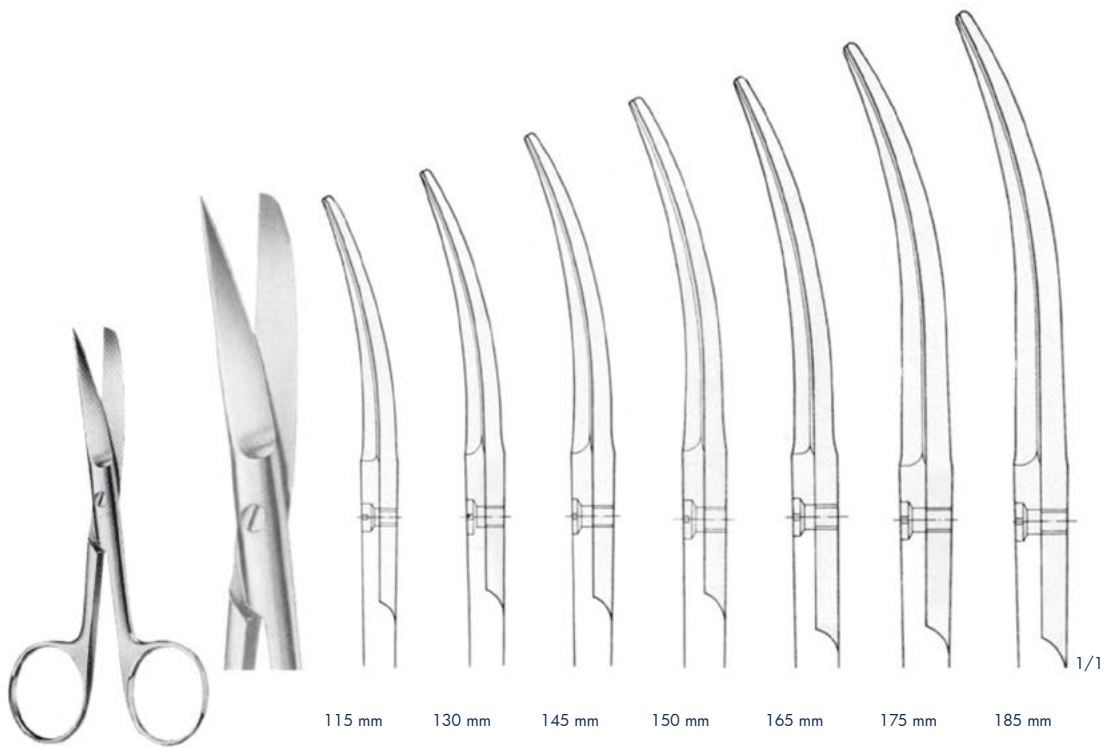

Standard patterns

Surgical Scissors



OS1110544 - OS1110545
slender patterns

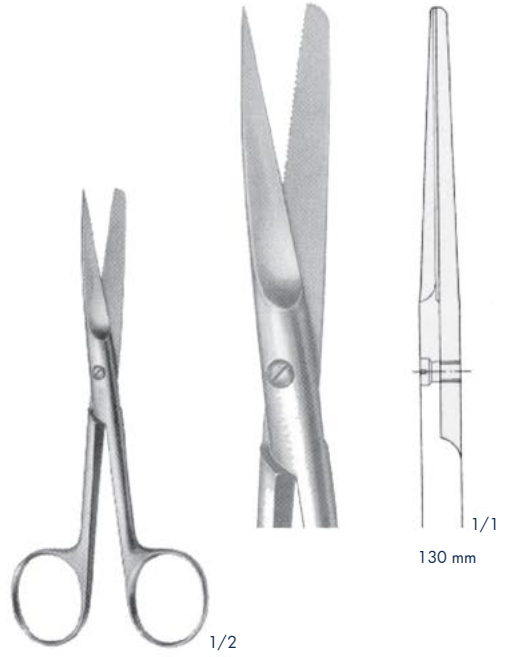

OS1110150
Scissors for wound edges, 1 blade serrated



OS1110546 - OS1110547
slender patterns

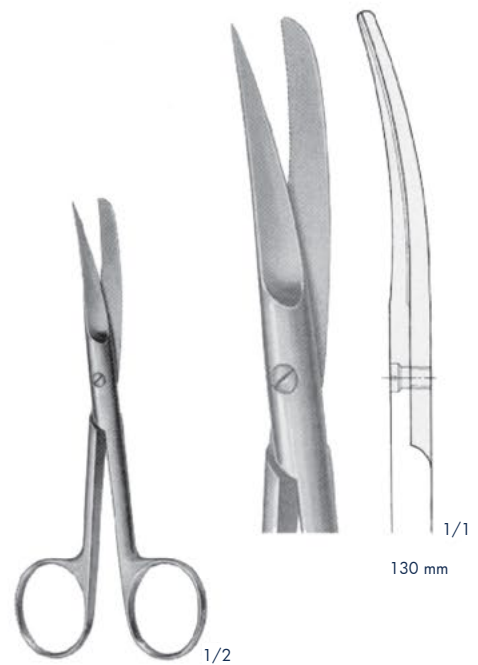

OS1110151
Scissors for wound edges, 1 blade serrated

Surgical Scissors

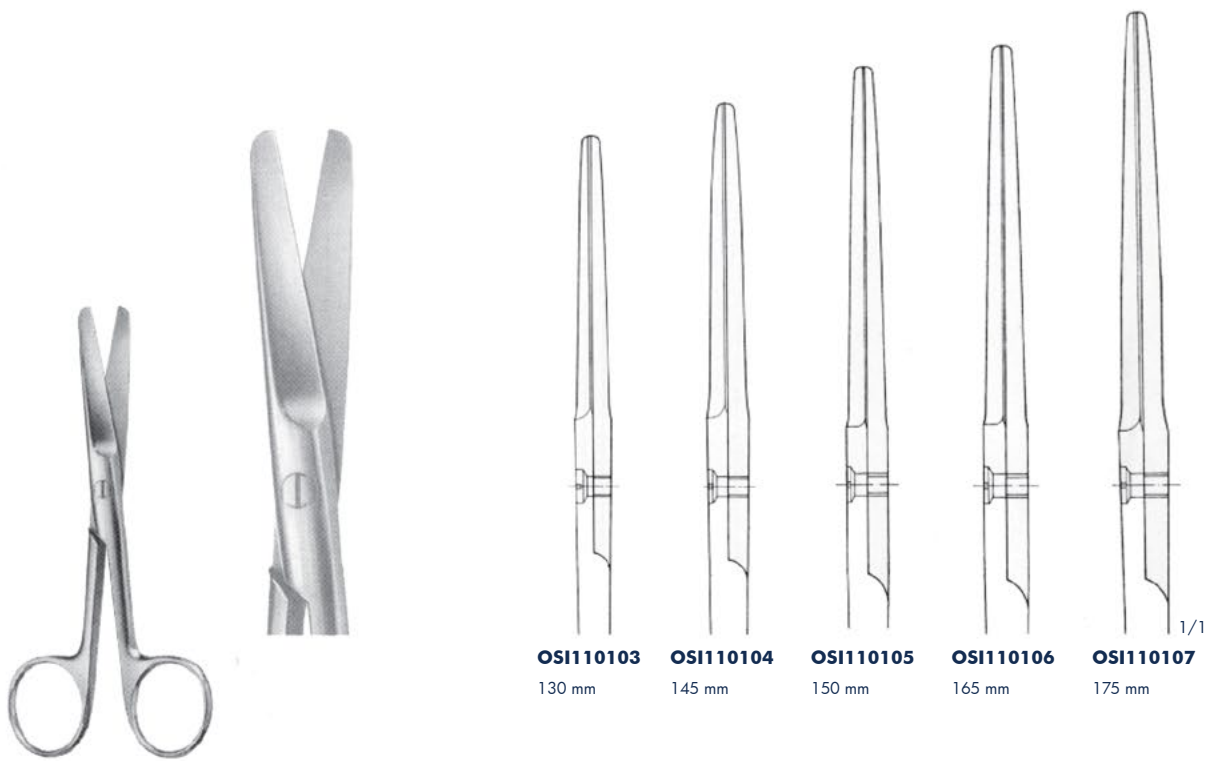

OSI110103 - OSI110107
slender patterns

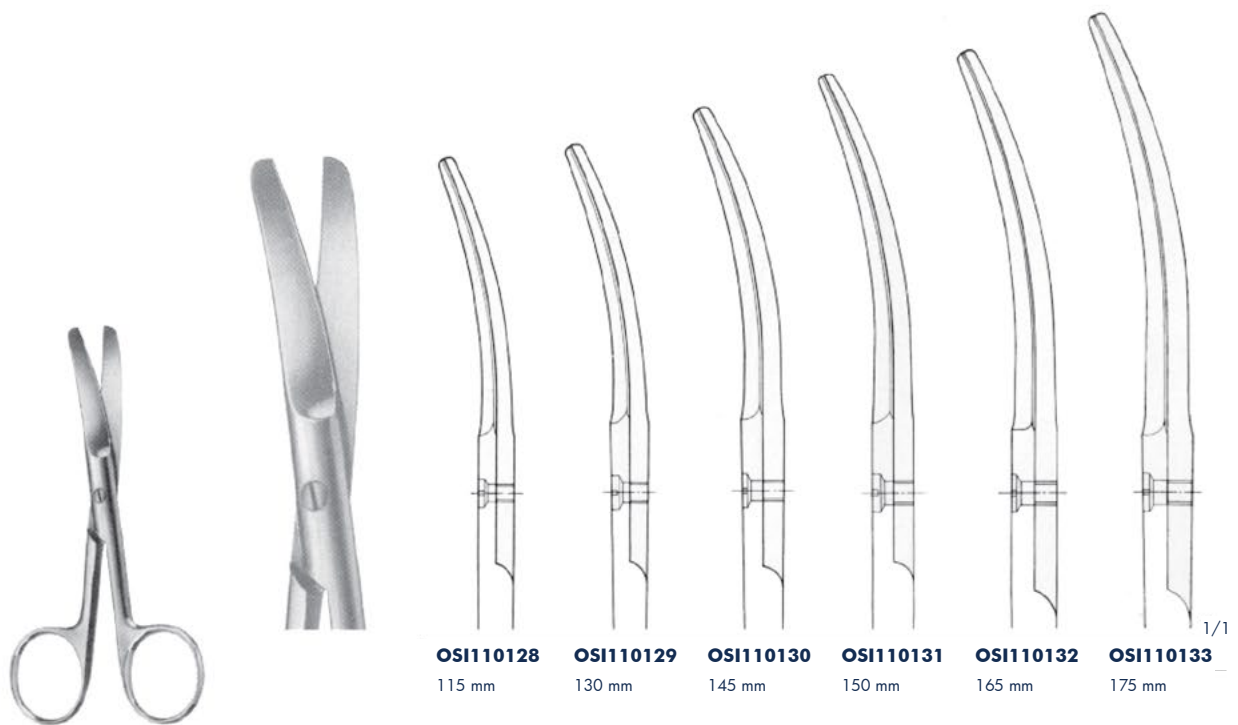

COOPER
OSI110128 - OSI110133
slender patterns

Surgical Scissors

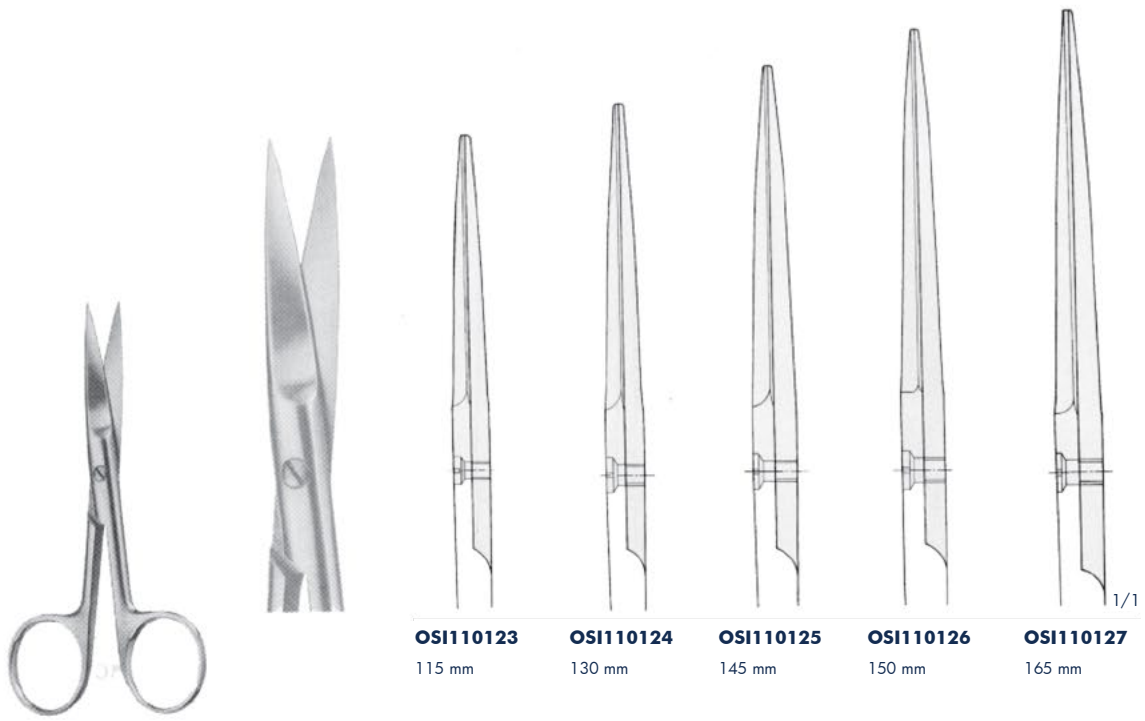

OSI110123 - OSI110127

Standard patterns



OSI110117 - OSI110120

Standard patterns

Surgical Scissors



DEAVER
OSI110548 - OSI110550
 with flat lock

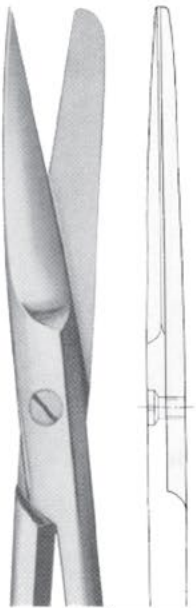

OSI110548
 145 mm

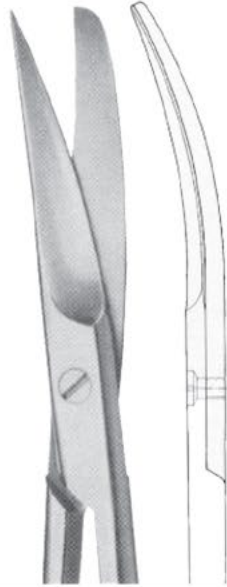

OSI110549
 145 mm

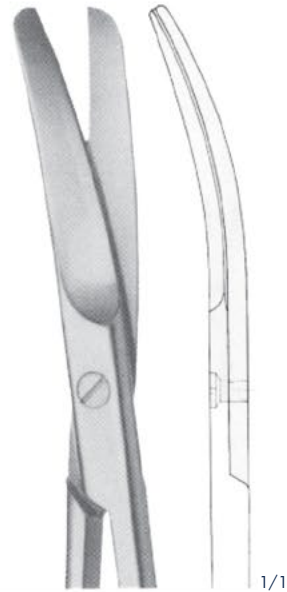

OSI110550
 145 mm



OSI110148 - OSI110551



OSI110148
 130 mm



OSI110149
 145 mm

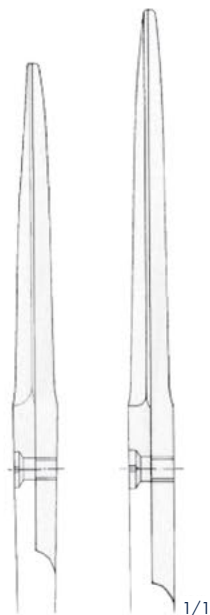

OSI110551
 165 mm

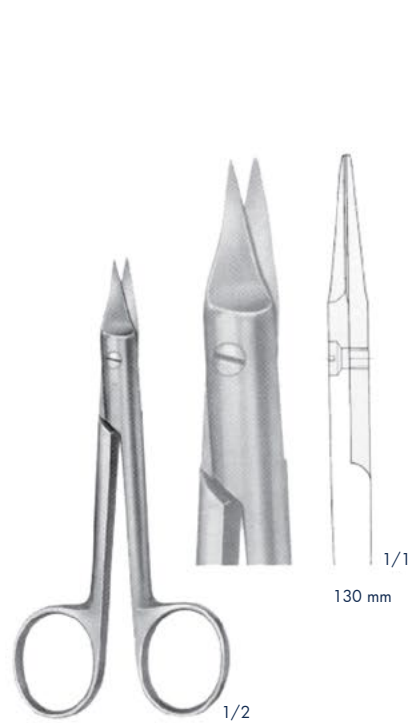

SYSTRUNK
OSI110552

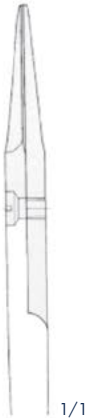

130 mm

Dissecting Scissors, fine patterns



GRAEFE

OSI110553

Dissecting scissors
100 mm



OSI110189

OSI110190

OSI110189 - OSI110190

Dissecting scissors
115 mm



LITTLER

OSI110559

Dissecting scissors,
tips with eye for suture
115 mm

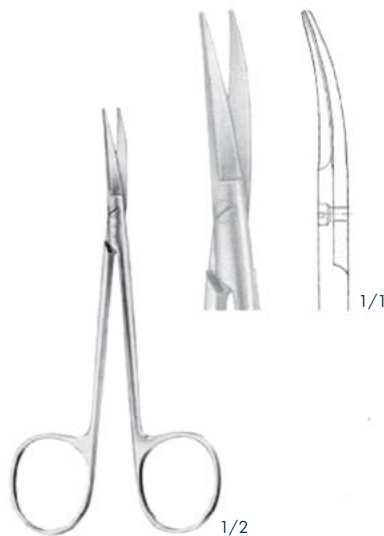

COTTLE

OSI110561

Bulldog scissors
115 mm

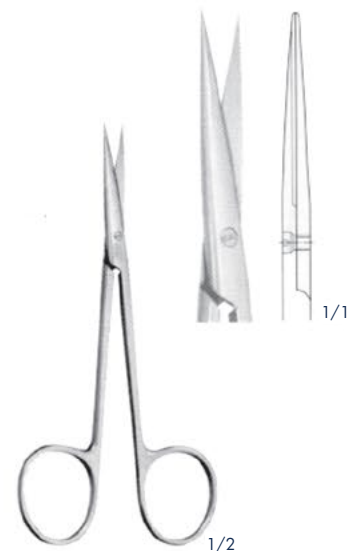

KILNER

OSI110562

fine dissecting scissors
115 mm

Dissecting Scissors, fine patterns



COTTLE-MOSING
OSI110565 - OSI110566
Scissors for plastic surgery
105 mm



COTTLE-KNAPP
OSI110353 - OSI110354
Scissors for plastic surgery
105 mm



FOMON
OSI110567 - OSI110229
Lower lateral scissors



LANDOLT
OSI110568 - OSI110584
Enucleation scissors
120 mm

Dissecting Scissors, fine patterns



OSI110585

OSI110588

STEVENS
OSI110585 - OSI110588
 Vessel- and tendon scissors
 100 mm



OSI110596

STEVENS
OSI110596
 fine dissecting scissors
 110 mm



OSI110349
 sharp

OSI110350
 sharp

OSI110351
 blunt

OSI110352
 blunt

STEVENS
OSI110349 - OSI110352
 Vessel- and tendon scissors
 110 mm

Dissecting Scissors, fine patterns



OSI110275
125 mm

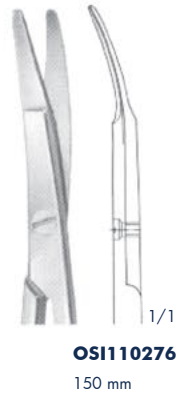

OSI110276
150 mm

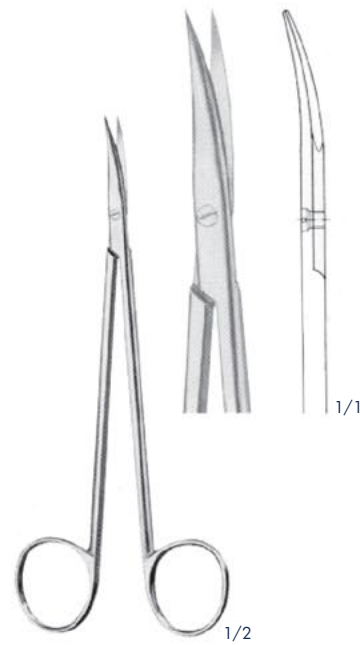

OSI110597
Nerve dissecting scissors,
blades outside semi-sharp
150 mm

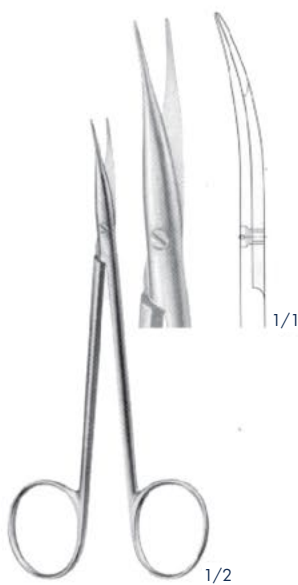

JAMESON-WERBER
OSI110598
Dissecting scissors
130 mm



JAMESON
OSI110599
Dissecting scissors
150 mm



REYNOLDS
OSI110601 - OSI110600
Dissecting scissors

OSI110601 145 mm
OSI110600 175 mm

Dissecting Scissors, fine patterns

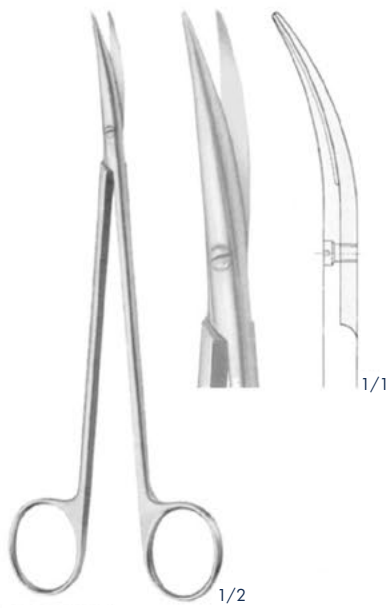

DE BAKEY
OSI110602

Arteriotomy scissors
175 mm



OSI110603
very delicate

OSI110308
delicate

TOENNIS-ADSON
OSI110603 - OSI110308

Dissecting scissors
175 mm



TOENNIS
OSI110301 - OSI110302

Dissecting scissors
180 mm

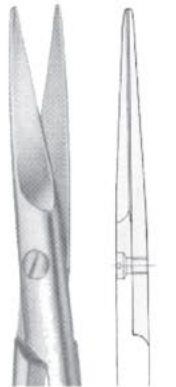

OSI110301
very delicate

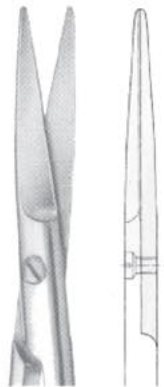

OSI110604
delicate



OSI110302
delicate

Dissecting Scissors, fine patterns



GORNEY

OS1110605 - OS1110607

Dissecting scissors for Plastic Surgery

Blades: outside semi-sharp
inside fine serrated

OS1110769

185 mm
Cartilage scissors,
blades cutting on
both sides

Surgical - and Dissecting Scissors

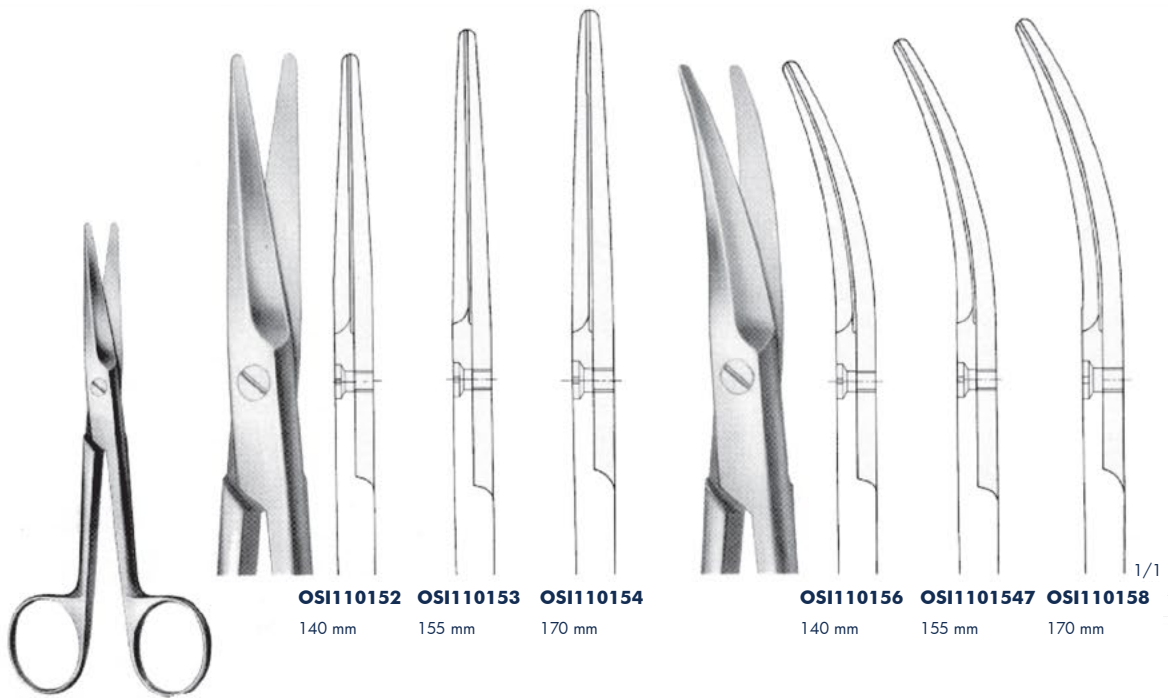

TUBBS
OSI110152 - OSI110158

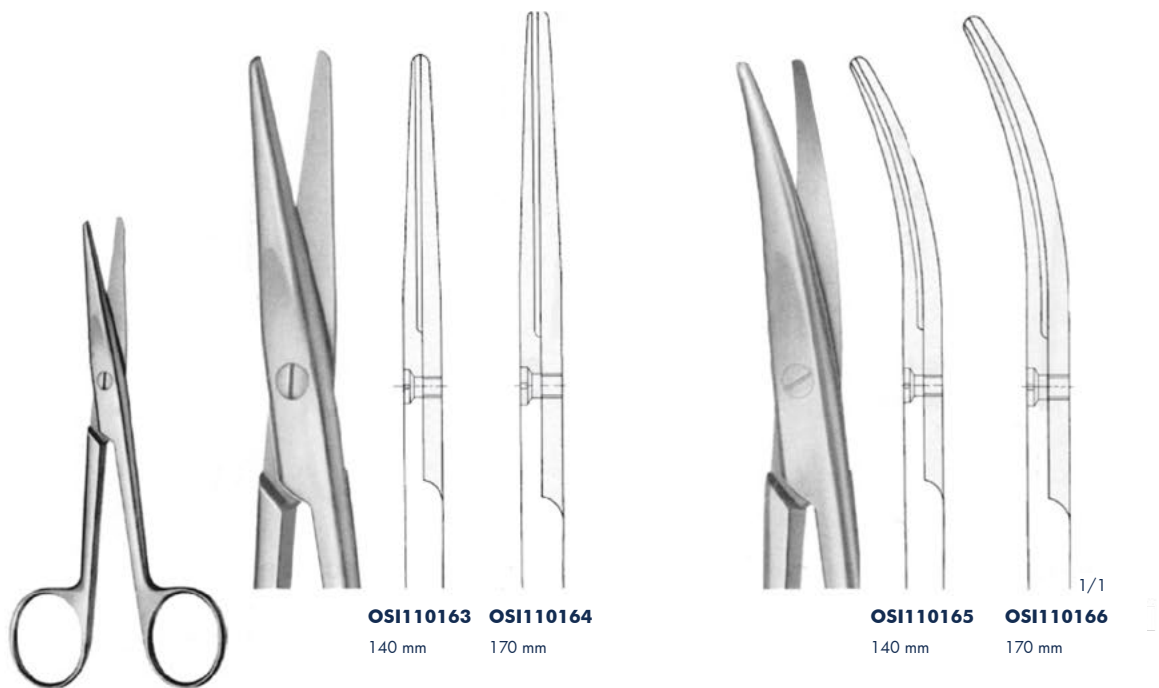

MAYO-STILLE
OSI110163 - OSI110166

Dissecting Scissors



MAYO-STILLE
OSI110608 - OSI110611
 with chamfered blades

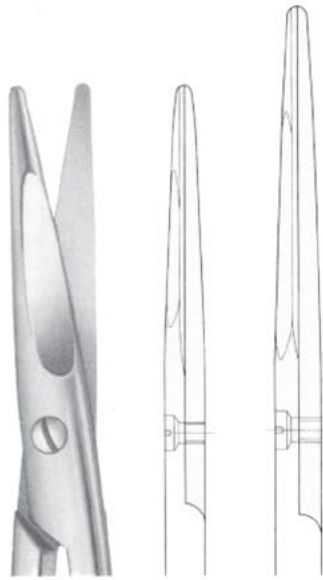

OSI110608 140 mm
OSI110609 170 mm



OSI110610 140 mm
OSI110611 170 mm



MAYO
OSI110612 - OSI110613
 with chamfered blades

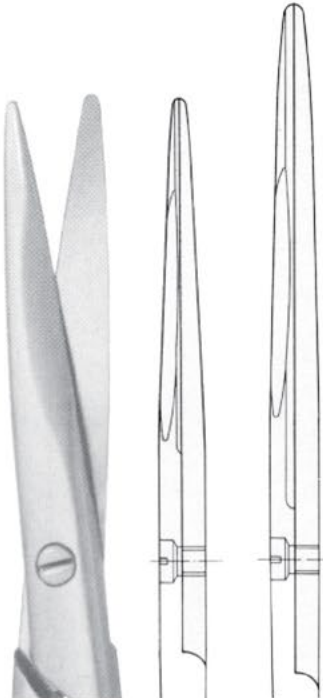

OSI110612 190 mm
OSI110613 215 mm



OSI110614 190 mm
OSI110615 215 mm

Dissecting Scissors



MATO-NOBLE
OSI110173 - OSI110174
broad pattern

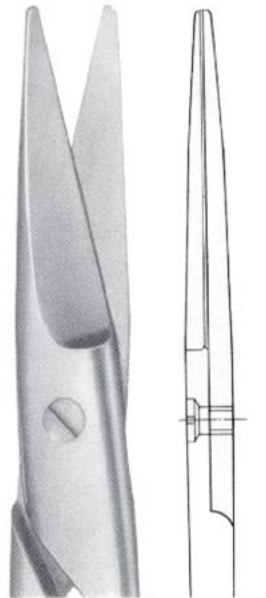

OSI110173
170 mm

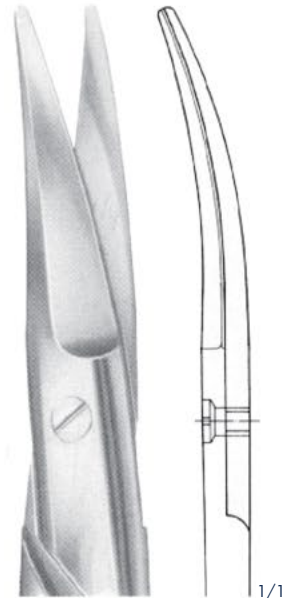

OSI110174
170 mm



MATO-HARRINGTON
OSI110160 - OSI110161

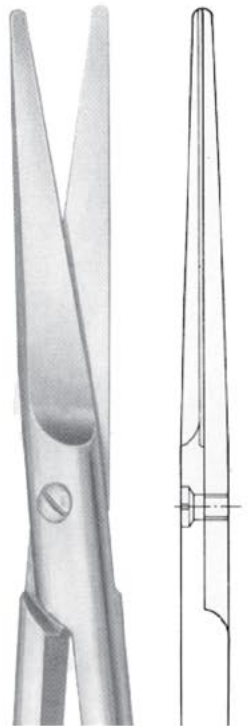

OSI110160
230 mm

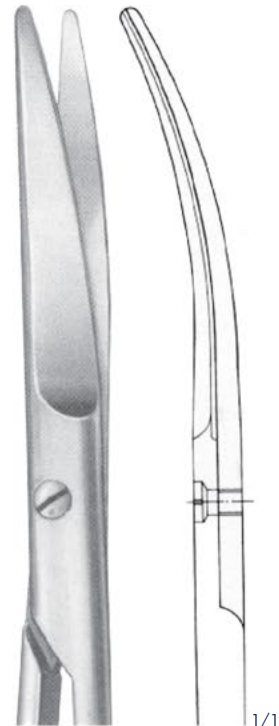

OSI110161
230 mm

Dissecting Scissors



STILLE
OSI110616 - OSI110617
150 mm

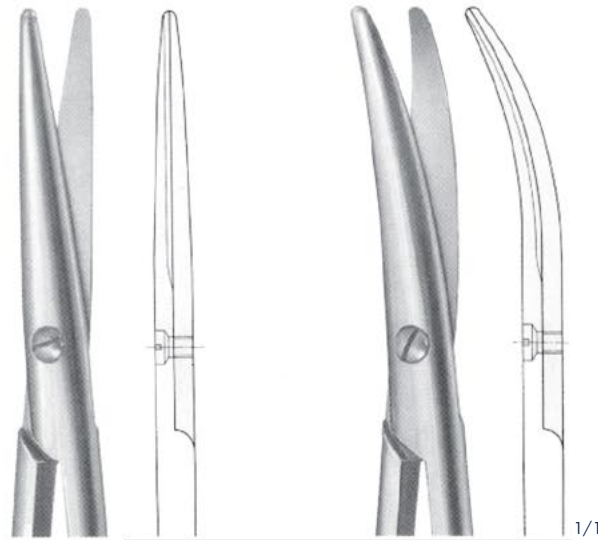

OSI110616

OSI110617



LEXER
OSI110241 - OSI110243
narrow

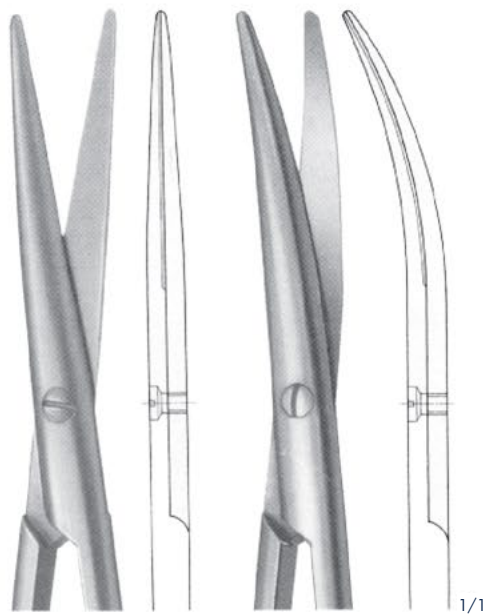

OSI110241
165 mm

OSI110243
165 mm

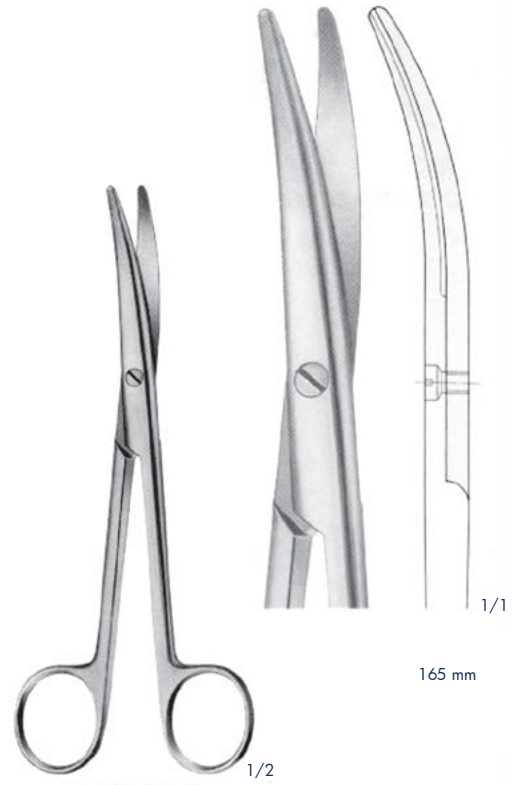

MAYO-LEXER
OSI110618
Standard

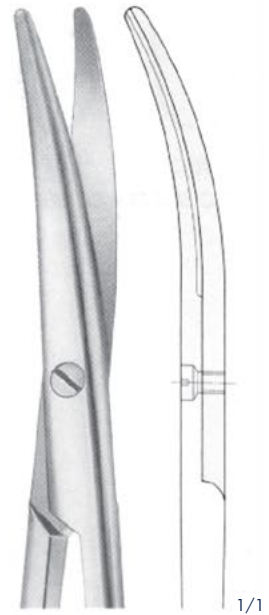

165 mm

Dissecting Scissors

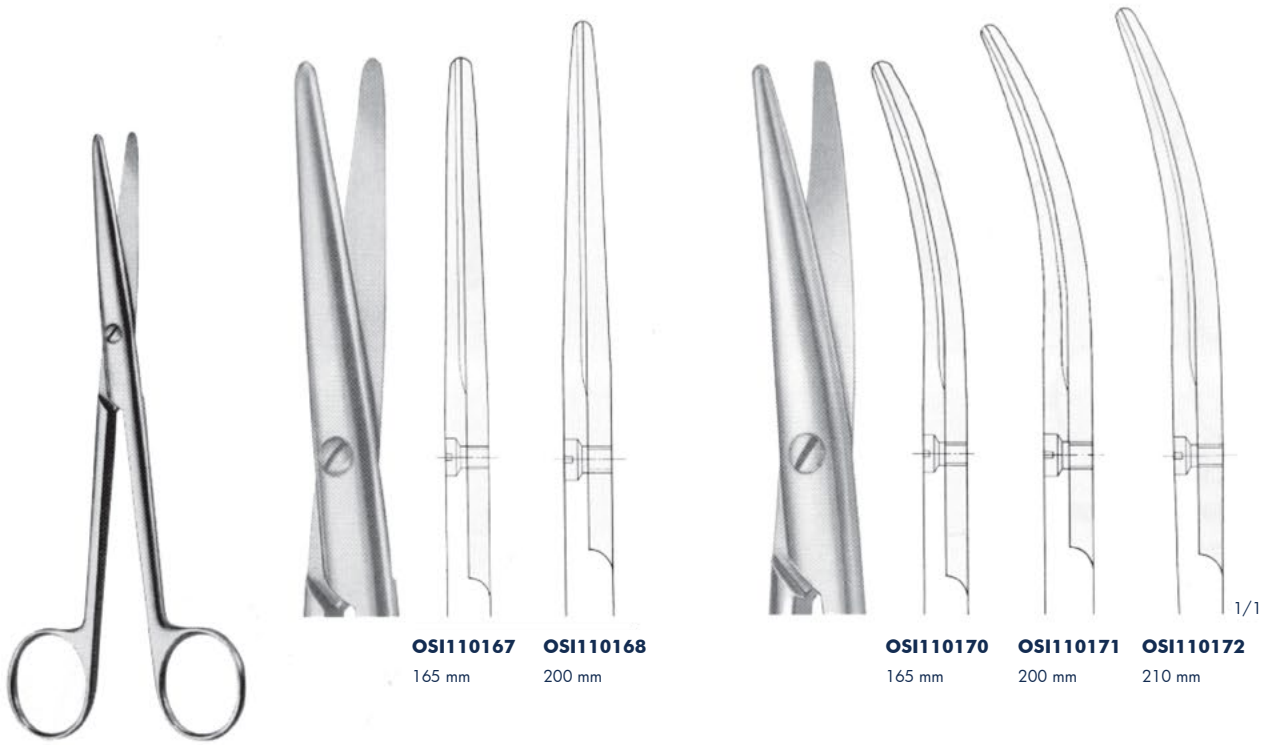

MAYO
OSI110167 - OSI110168

OSI110167 165 mm
OSI110168 200 mm

OSI110170 165 mm
OSI110171 200 mm
OSI110172 210 mm

Dissecting Scissors



OSI110194

OSI110197

1/1

1/2

BABY-METZENBAUM

OSI110194 - OSI110197

145 mm



OSI110619

OSI110620

1/1

1/1

1/2

METZENBAUM

OSI110619 - OSI110620

160 mm

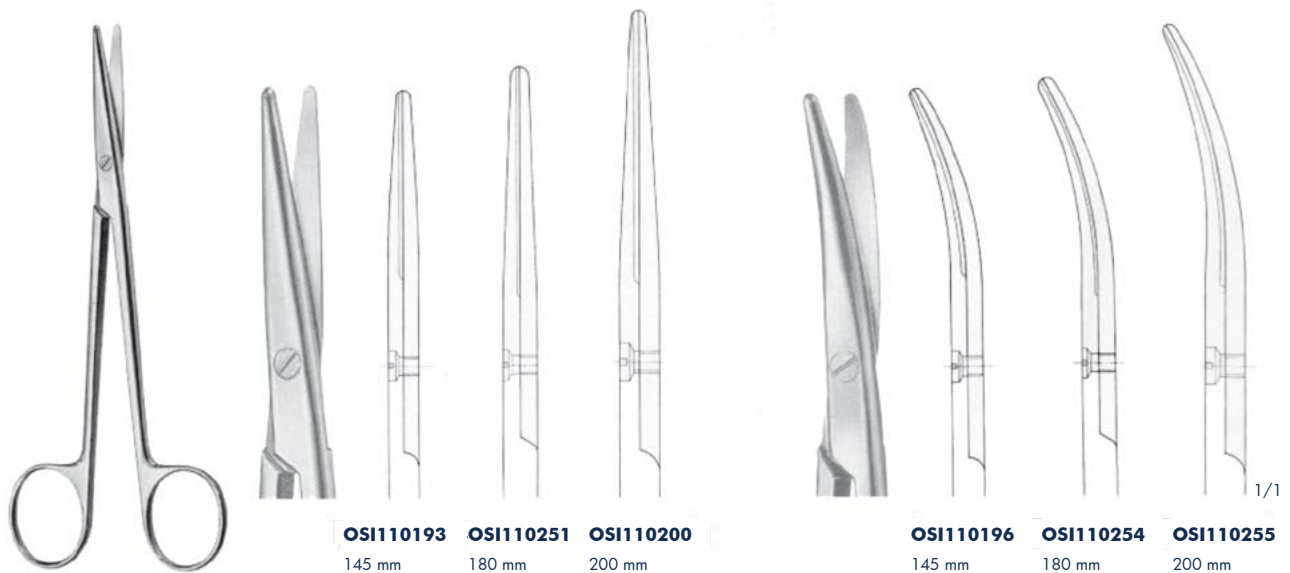

OSI110193

OSI110251

OSI110200

145 mm

180 mm

200 mm

OSI110196

OSI110254

OSI110255

145 mm

180 mm

200 mm

1/1

METZENBAUM

OSI110193 - OSI110255

Dissecting Scissors

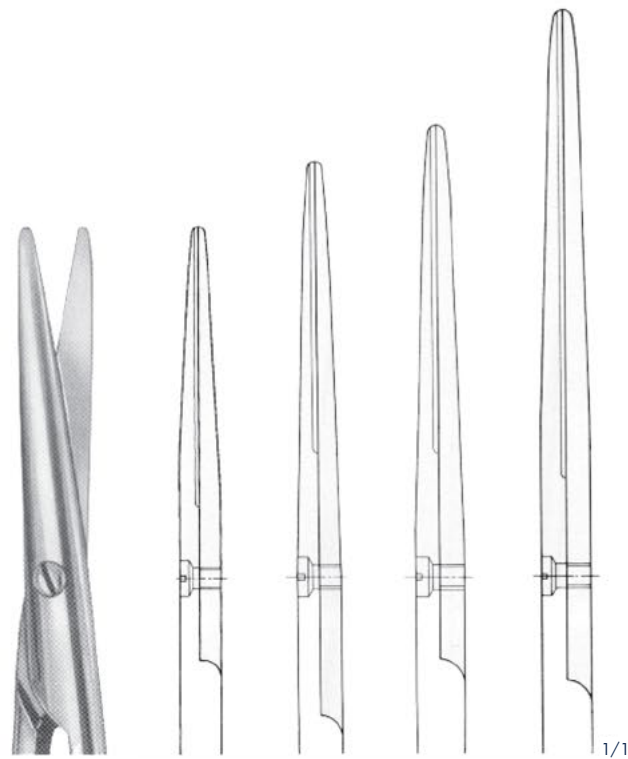

OSI110201 230 mm **OSI110202** 250 mm **OSI110203** 280 mm **OSI110204** 305 mm



NELSON-METZENBAUM
OSI110201 - OSI110222



OSI110219 230 mm **OSI110220** 250 mm **OSI110221** 280 mm **OSI110222** 305 mm

Dissecting Scissors, Cartilage Scissors

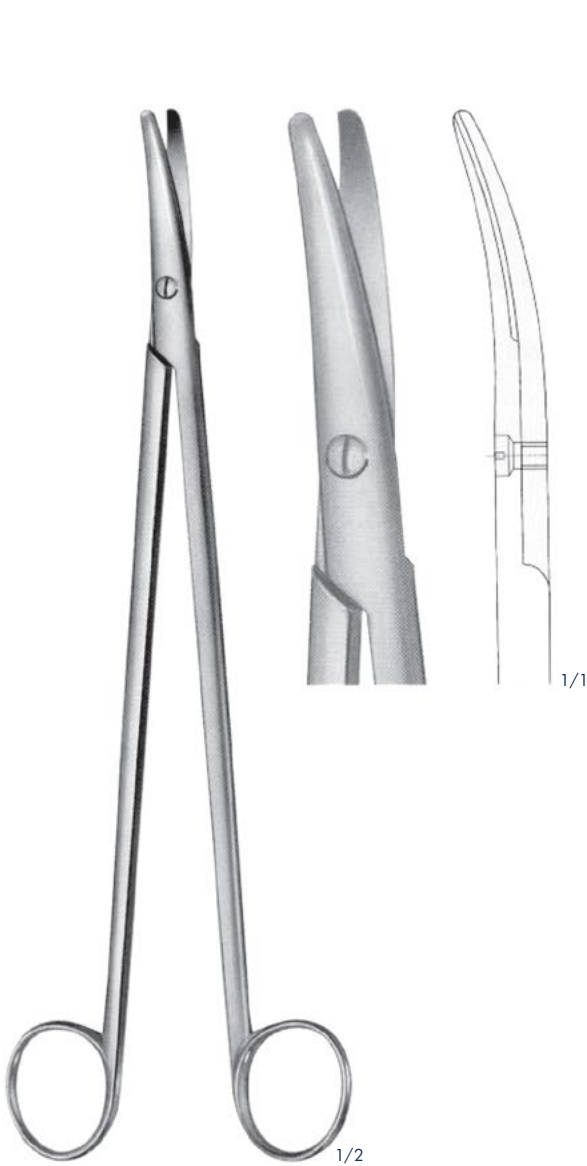

WELLER
OS1110621
heavy pattern
280 mm

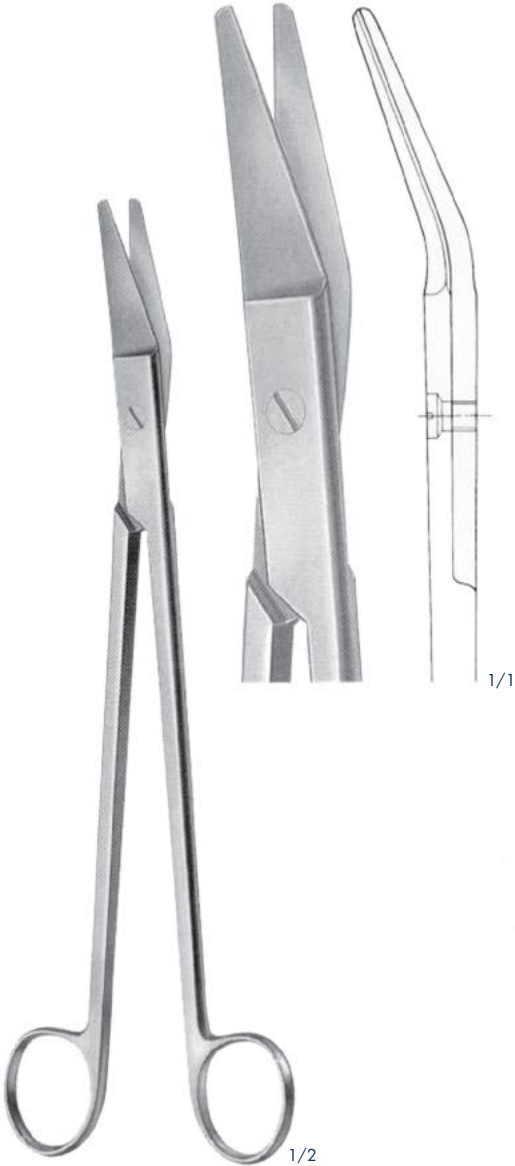

RESANO
OS1110622
Cartilage scissors
250 mm

Delicate Scissors



OSI110623 - OSI110624
Ligature scissors
110 mm



OSI110625
1 blade serrated
130 mm



OSI110626 - OSI110627
120 mm

Surgical Scissors



1/2

OSI110628 - OSI110629

145 mm



OSI110628

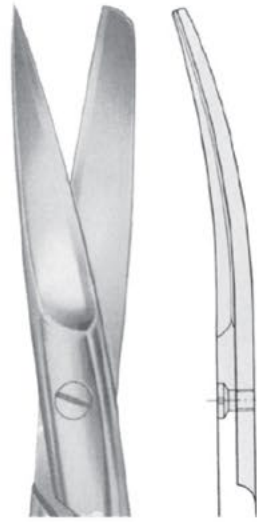

1/1

OSI110629



1/2

OSI110630

145 mm

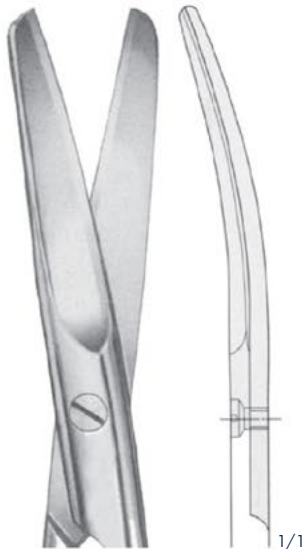

1/1



1/2

OSI110631

145 mm



1/1

Dissecting Scissors



MAYO
OSI110632 - OSI110635

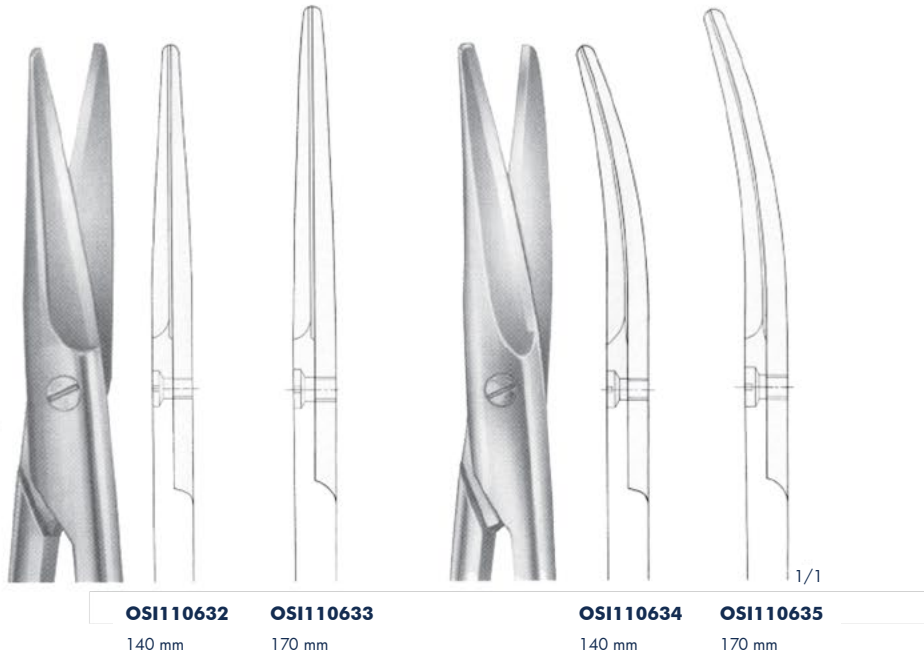

LEXER
OSI110451
narrow
165 mm

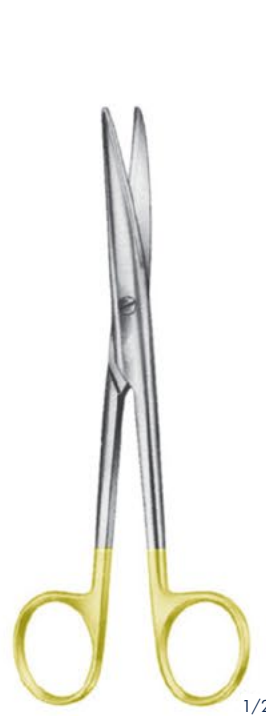
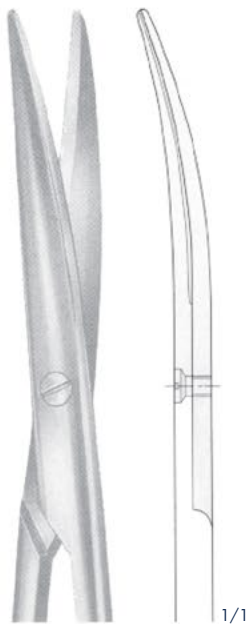

MAYO-LEXER
OSI110445
165 mm

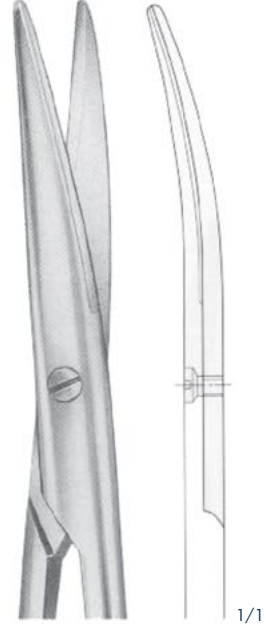

Dissecting Scissors



1/2

OSI110429 - OSI110429
115 mm

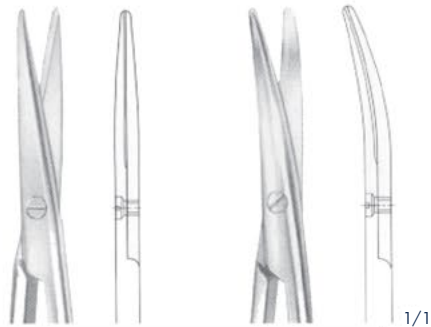

OSI110427

OSI110429

1/1



1/2

BABY-METZENBAUM
OSI110428 - OSI110430
145 mm

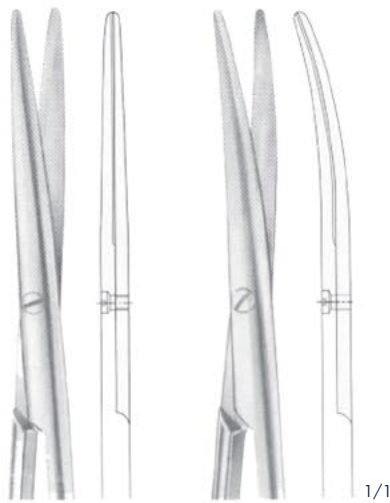

OSI110428

OSI110430

1/1



1/2

TOENNIS-ADSON
OSI110636
175 mm

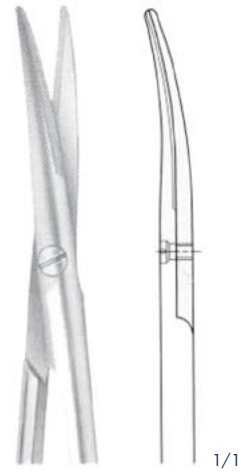

1/1

Dissecting Scissors



OSI110431 180 mm
OSI110432 200 mm
OSI110433 230 mm
OSI110437 180 mm
OSI110438 200 mm
OSI110439 230 mm

METZENBAUM
 OSI110431 - OSI110439



OSI110462 260 mm
OSI110463 280 mm
OSI110637 285 mm

NELSON-METZENBAUM
 OSI110462 - OSI110637

Dissecting Scissors

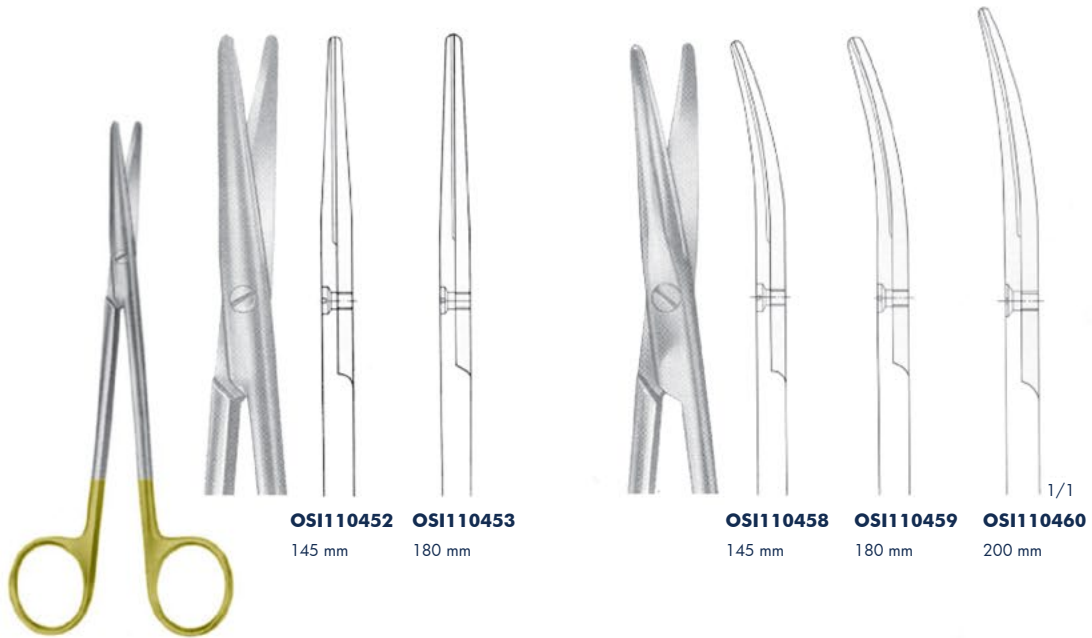

METZENBAUM
OS1110452 - OS1110460

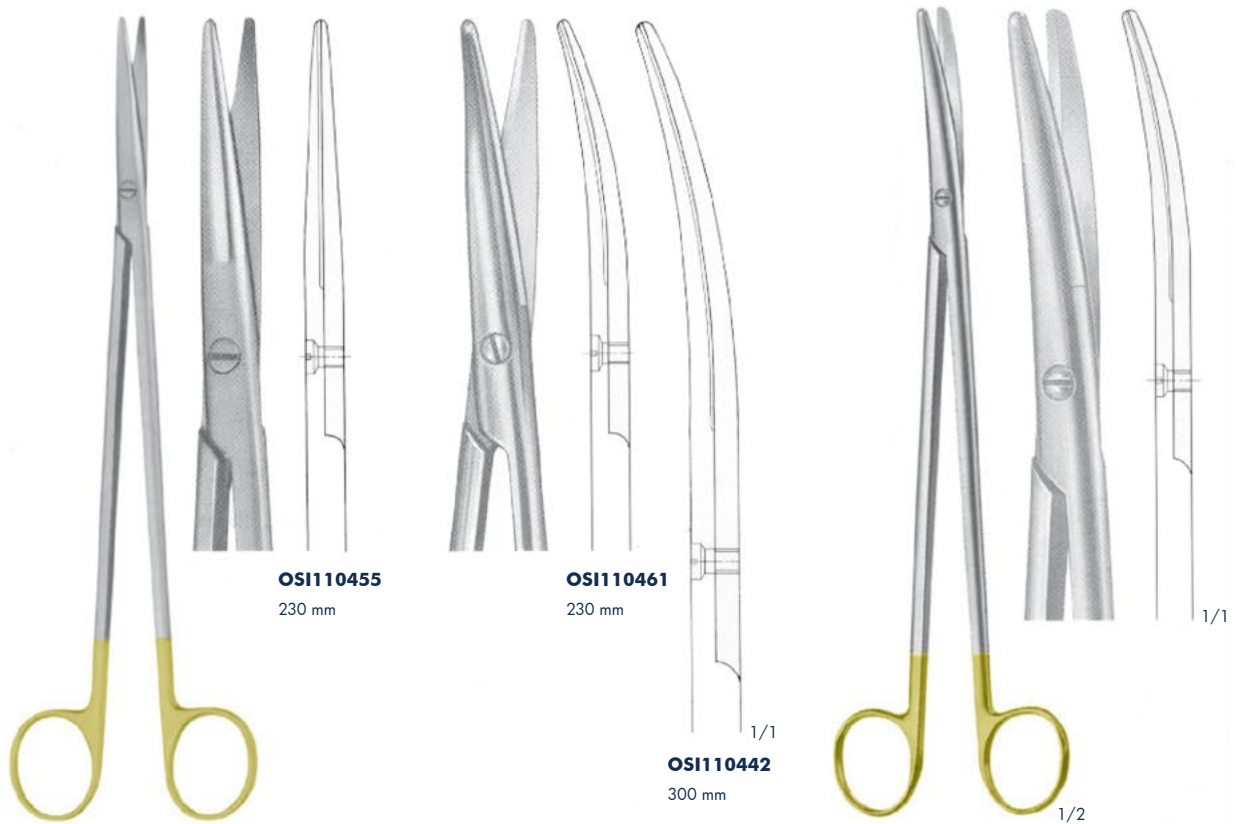

NELSON-METZENBAUM
(MC INDOE)
OS1110455 - OS1110442

METZENBAUM
OS1110456
broad blade ends
230 mm

Scissors

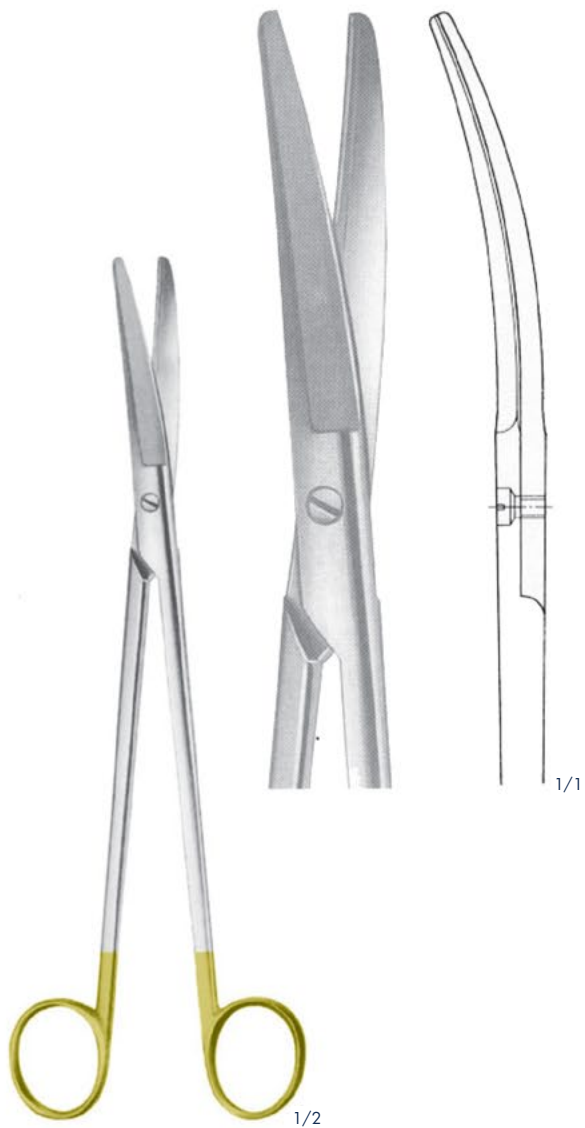

WERTHEIM

OSI110638

Dissecting scissors
230 mm



OSI110639
200 mm

OSI110640
230 mm

SIMS

OSI110639 - OSI110640

Uterine scissors

Scissors



Cut Scissors

- cut prevents tissue from slipping out

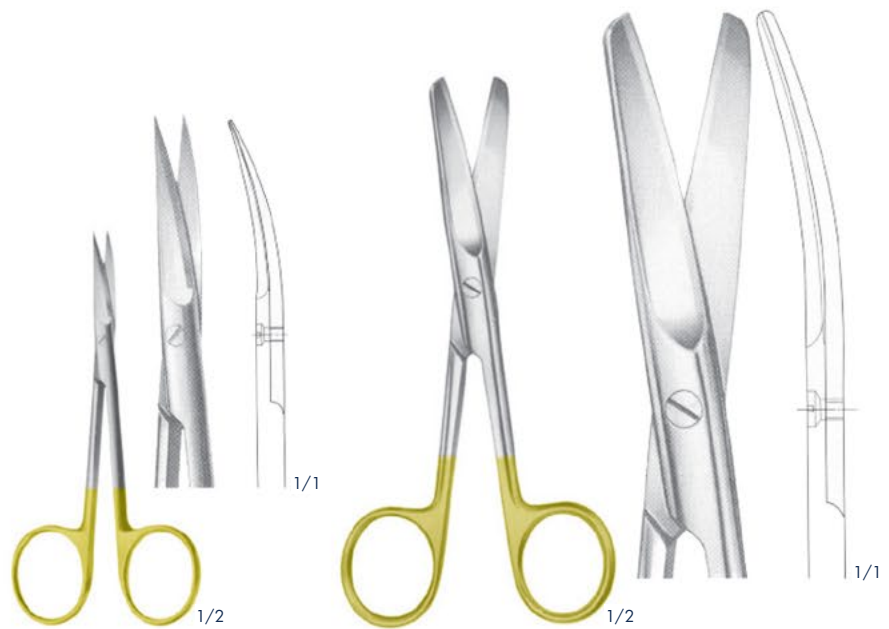

OS1110644
Ligature scissors
110 mm

OS1110645
Surgical scissors
145 mm

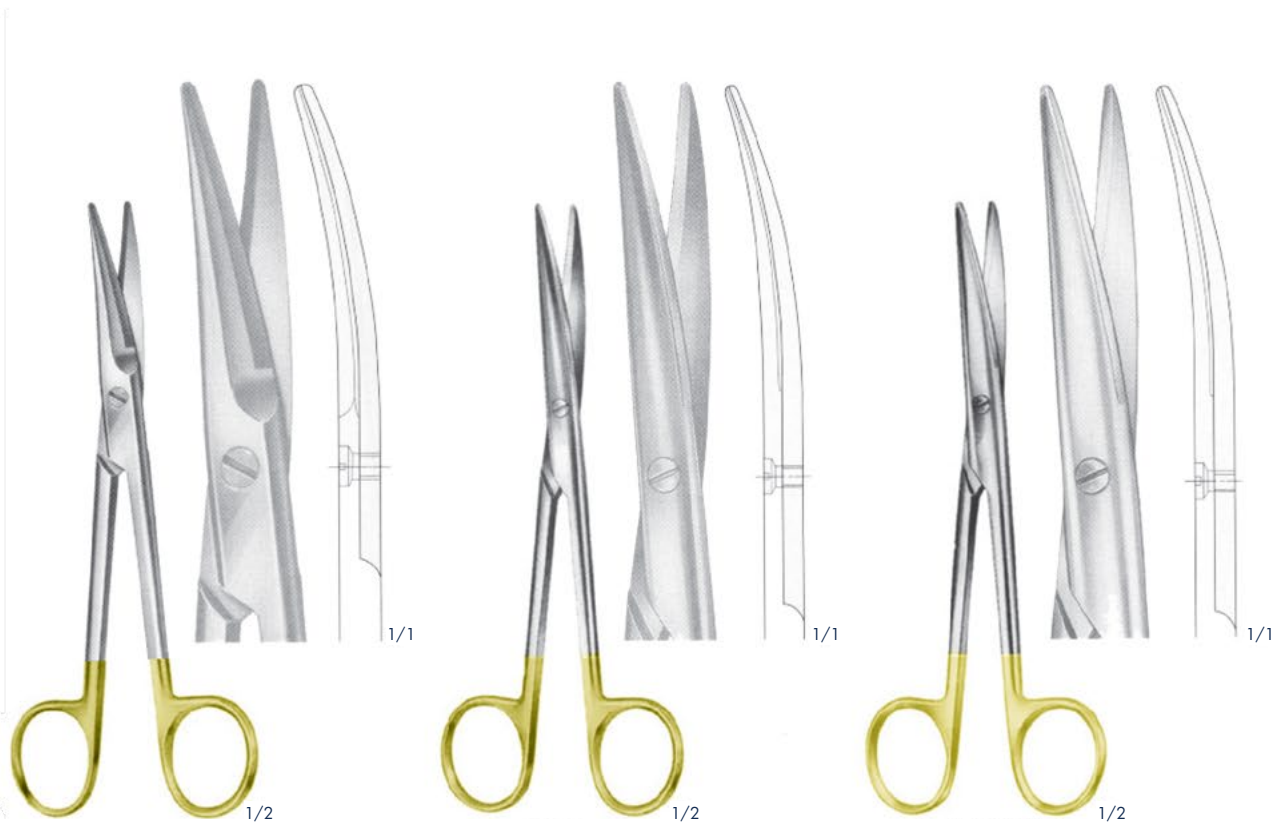

MAYO
OS1110646
Dissecting scissors
170 mm

LEXER
OS1110647
Dissecting scissors, slender
165 mm

MAYO-LEXER
OS1110648
Dissecting scissors
165 mm

Cut Scissors



OSI110649
115 mm



BABY-METZENBAUM
OSI110650
145 mm

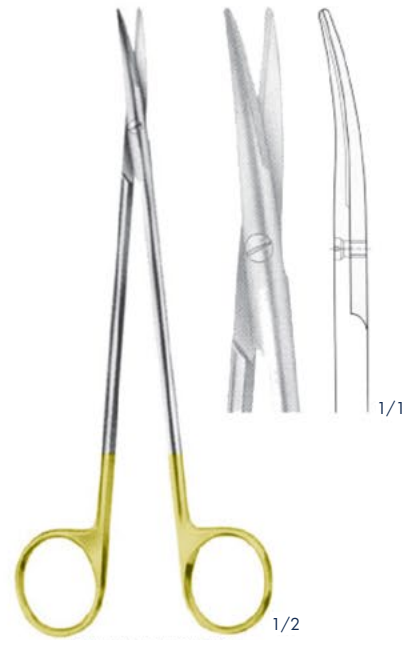

TOENNIS-ADSON
OSI110651
175 mm



METZENBAUM
OSI110652 - OSI110654



NELSON-METZENBAUM
OSI110655 - OSI110656

Cut Dissecting Scissors



METZENBAUM
OS1110657 - OS1110659

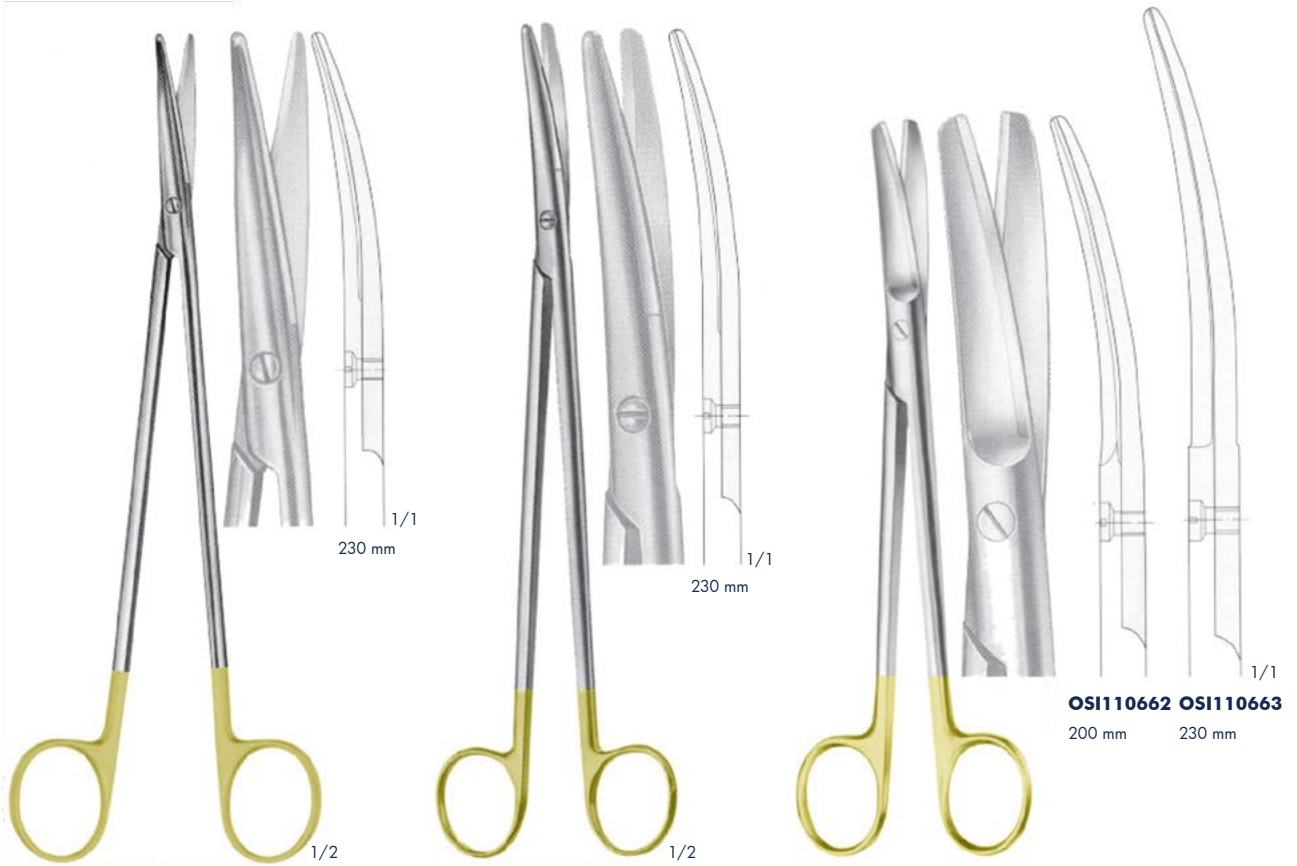

NELSON-METZENBAUM
OS1110660

METZENBAUM
OS1110661
broad blade ends

SIMS
OS1110662 - OS1110663
Uterine scissors

Ligature Scissors

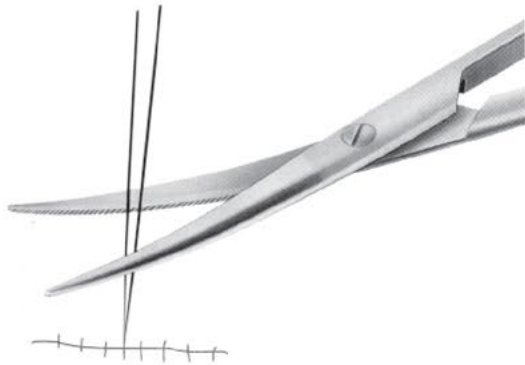

especially for cutting suture materials

- Carbide inserts guarantee permanent cutting edge (also in the distal area of the blades)
- -cut prevents suture materials from slipping out
- Ligature scissors are identified by
 - 1 black and
 - 1 goldplated ring



OS1110664
Ligature scissors
145 mm

OS1110665
Ligature scissors
180 mm

OS1110666
Ligature scissors
230 mm

OS1110667
Ligature scissors
260 mm

Scissors, ergonomic handle



HELLBERG/KUPKA

OSI110668

Micro scissors,
sharp/sharp, curved
210 mm



REIN/KUPKA

OSI110669

Dissecting scissors,
curved
195 mm

Instruments provide the surgeon with a maximum of ergonomical comfort.

The optimized design of the Instruments offers a fatigue-free working especially with regard to difficult suture and anastomosis techniques.

For further details see our leaflet

Vessel Scissors

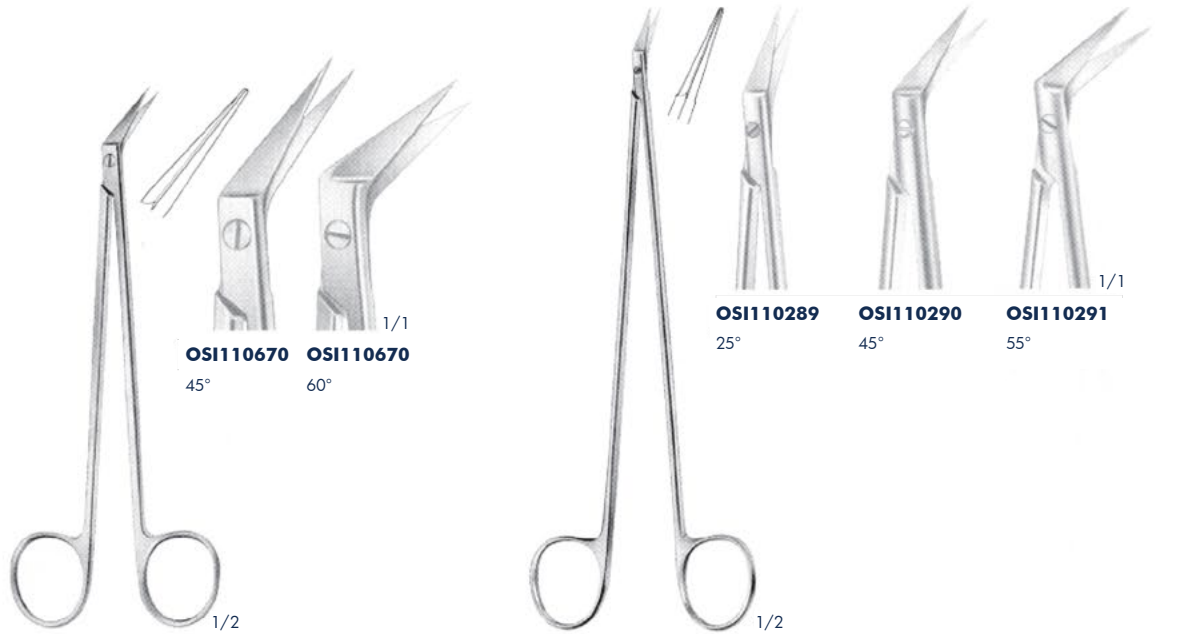

DE BAKLEY

Vessel scissors
155 mm

DIETRICH-HEGEMANN

OSI110289 - OSI110291
Vessel scissors
180 mm

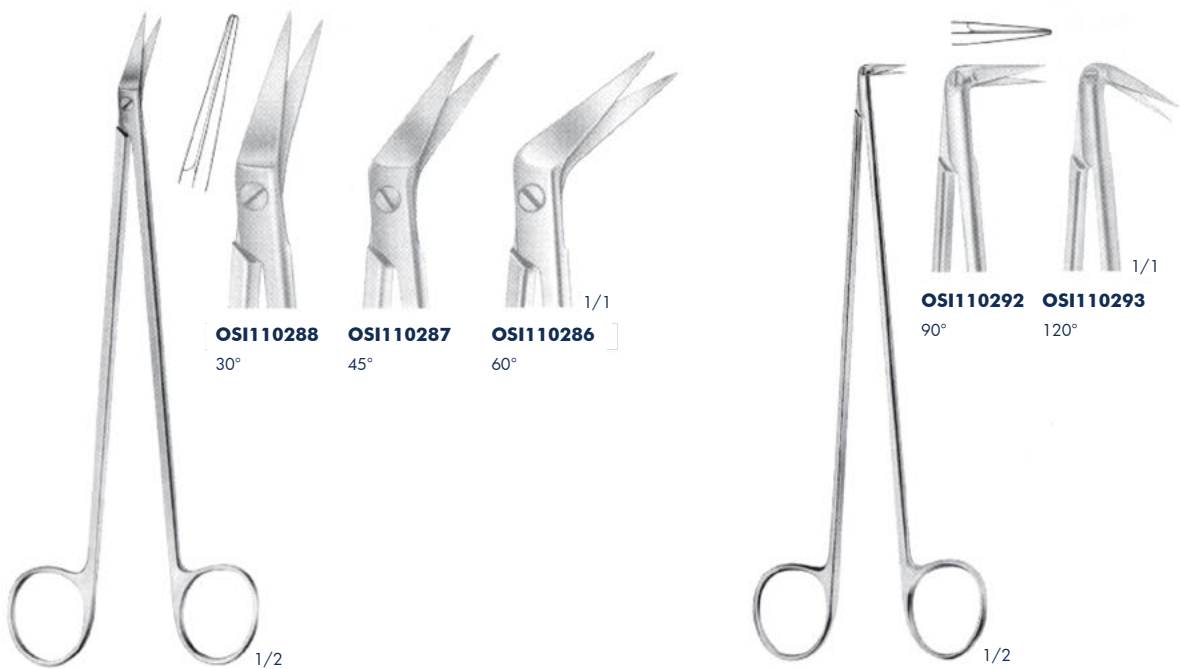

POTTS-DE MARTEL

OSI110288 - OSI110286
Vessel scissors
185 mm

DIETRICH

OSI110292 - OSI110293
Vessel scissors
170 mm

Vessel Scissors

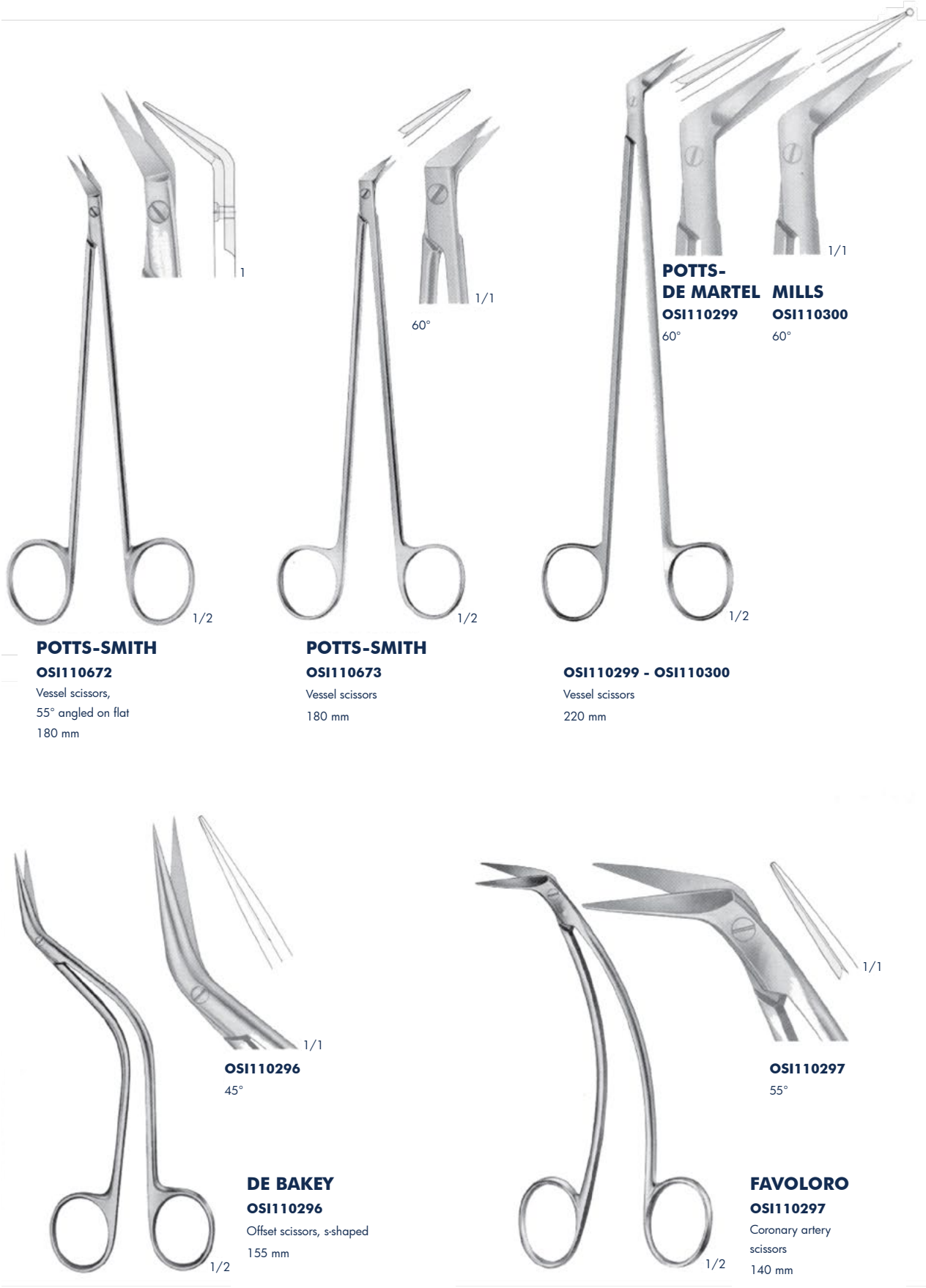

POTTS-SMITH
OSI110672
 Vessel scissors,
 55° angled on flat
 180 mm

POTTS-SMITH
OSI110673
 Vessel scissors
 180 mm

OSI110299 - OSI110300
 Vessel scissors
 220 mm

OSI110296
 45°

DE BAKEY
OSI110296
 Offset scissors, s-shaped
 155 mm

OSI110297
 55°

FAVOLORO
OSI110297
 Coronary artery
 scissors
 140 mm

Scissors for Vascular and Neuro - Surgery



SCHMIEDEN-TAYLOR
OSI110307
 Dura scissors
 155 mm



OLIVECRONA
OSI110304
 Dura scissors



STRULLY
OSI110674
 220 mm

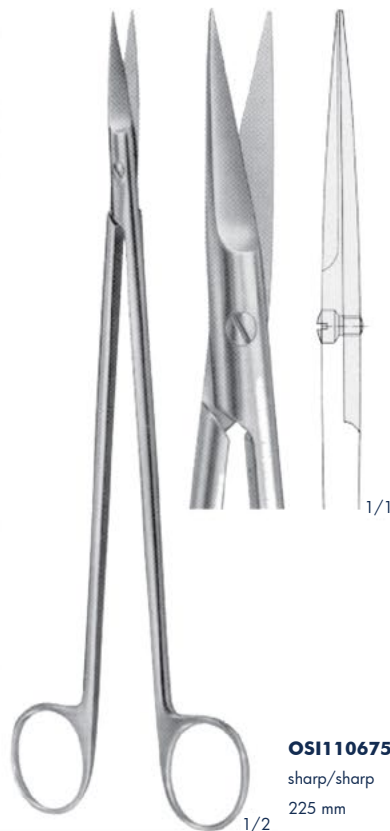

OSI110675
 sharp/sharp
 225 mm



STRULLY
OSI110305
 220 mm

Scissors for Vascular Surgery



OSI110676 straight very delicate
OSI110677 straight very delicate

OSI110676 - OSI110677
 190 mm

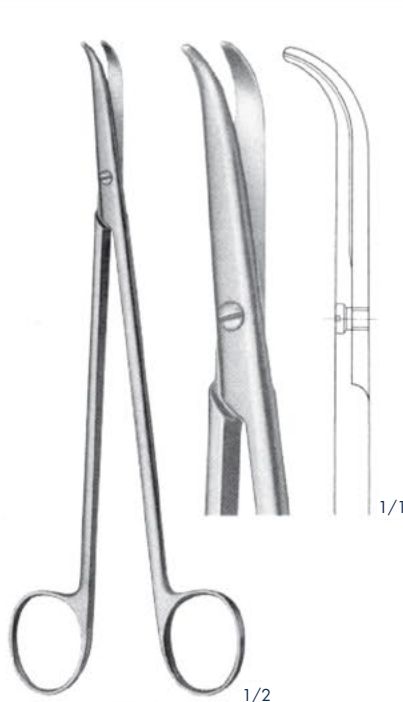

THOREK
OSI110678
 180 mm

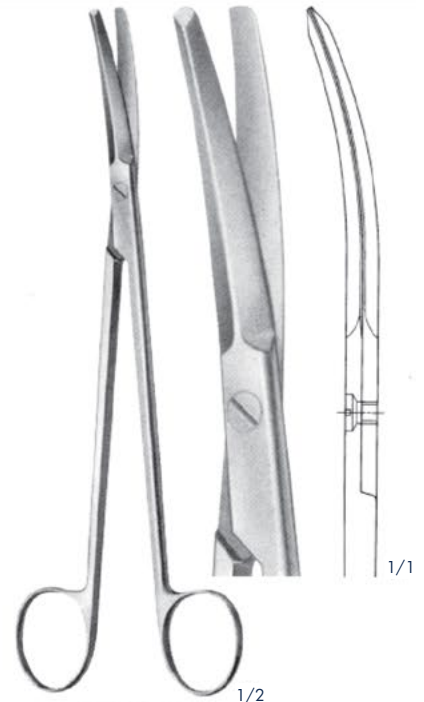

POTTS-SMITH
OSI110679
 190 mm

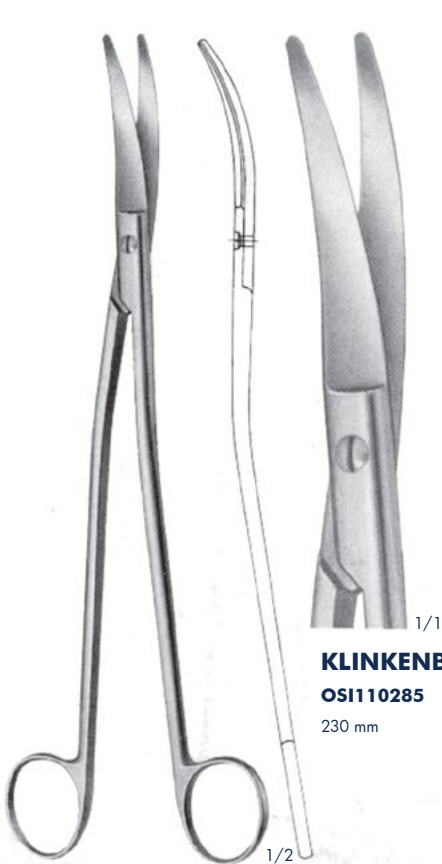

KLINKENBERGH-LOTH
OSI110285
 230 mm



SATINSKY
OSI110284
 245 mm

Nasal Scissors



FOMON
OSI110317
 Blades serrated
 145 mm



COTTLE
OSI110318
 165 mm



HEYMANN-KNIGHT
OSI110319
 175 mm



HEYMANN
OSI110680
 190 mm



KIRSTEIN
OSI110681
 Blades serrated
 175 mm

Tonsil Scissors



DEAN
OSI110311
Blades serrated
170 mm

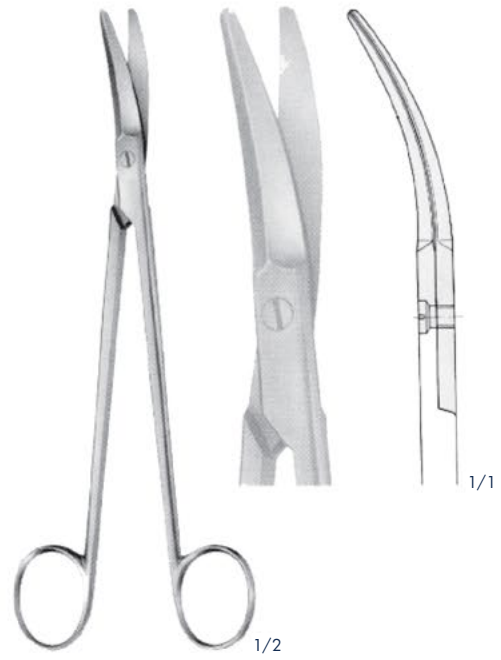

BOETTCHER
OSI110309
180 mm

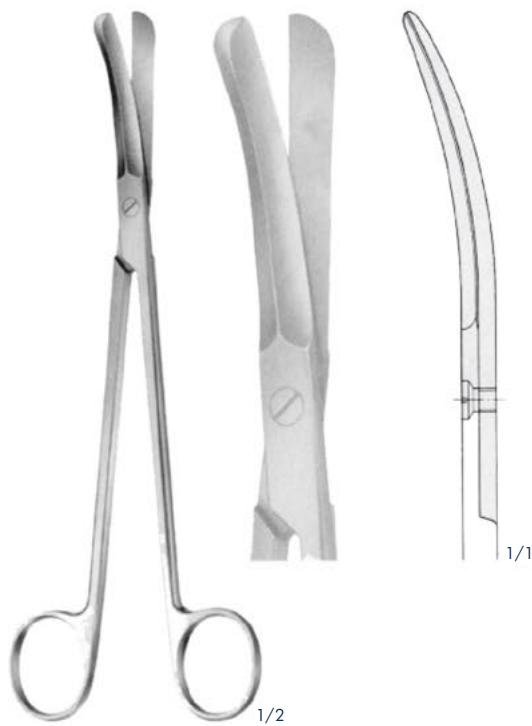

GOOD
OSI110313
195 mm

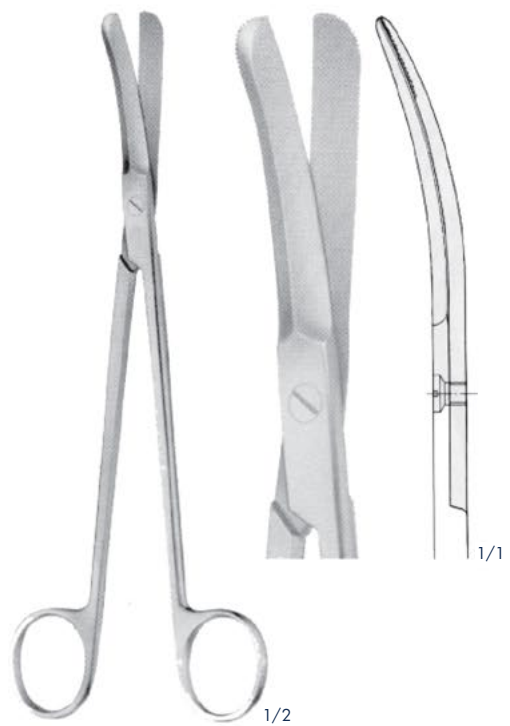

SCHWECKENDIEK
OSI110682
195 mm

Bone Shears

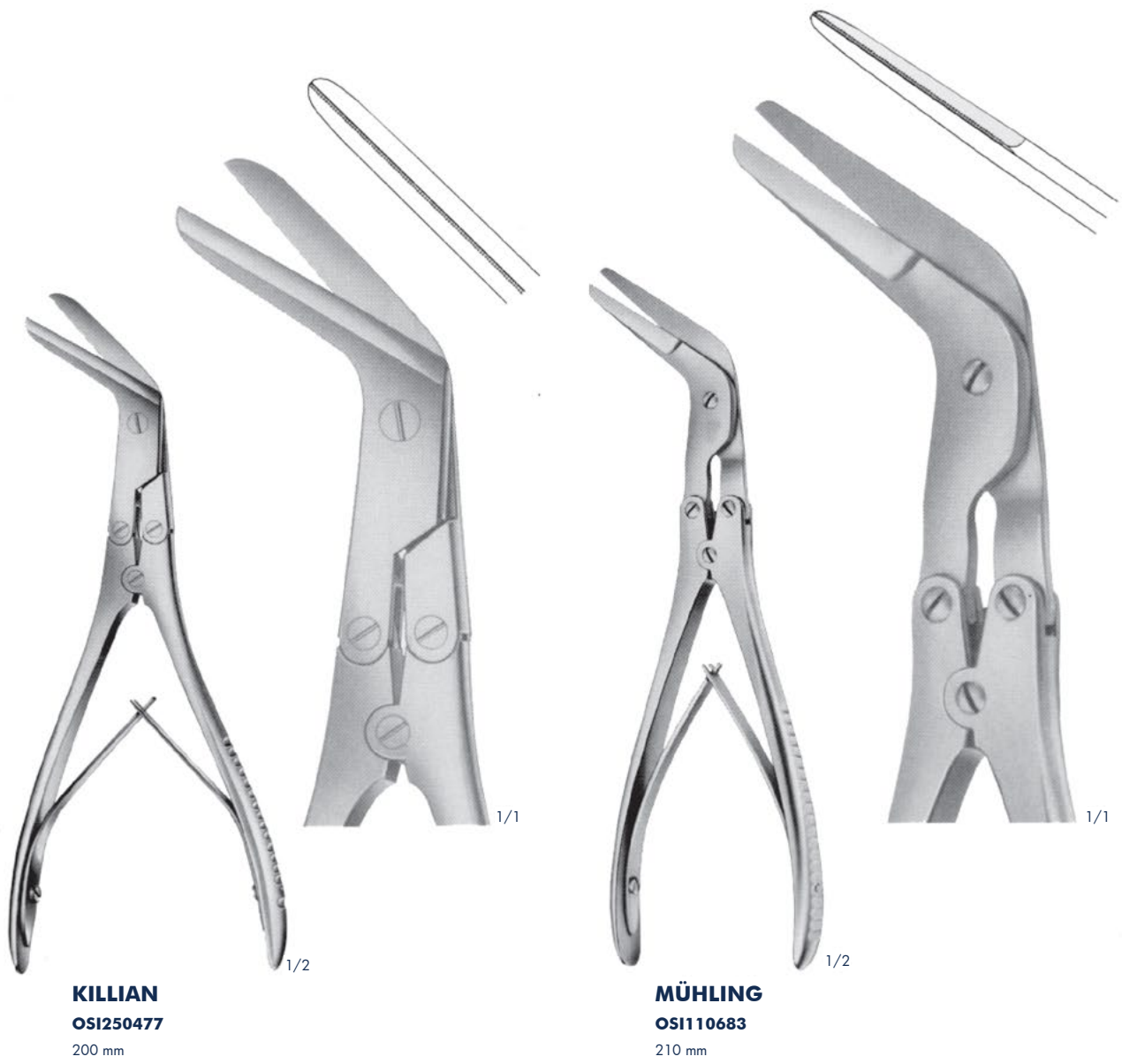

Bone Shears



OSI190614
225 mm

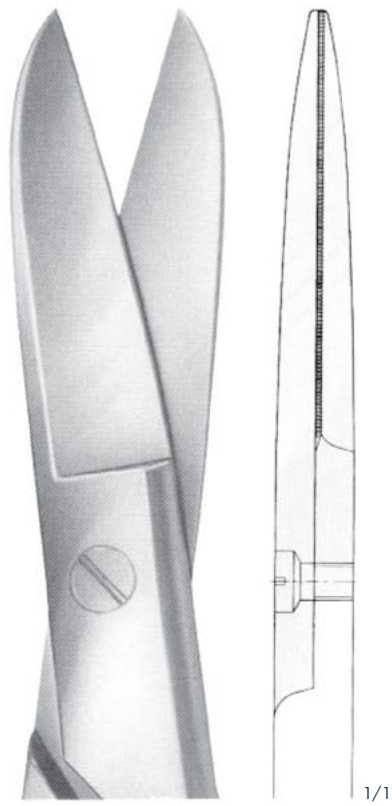

Scissors for deep Operations and for Gynaecology



SIMS
OSI110179 - OSI110182

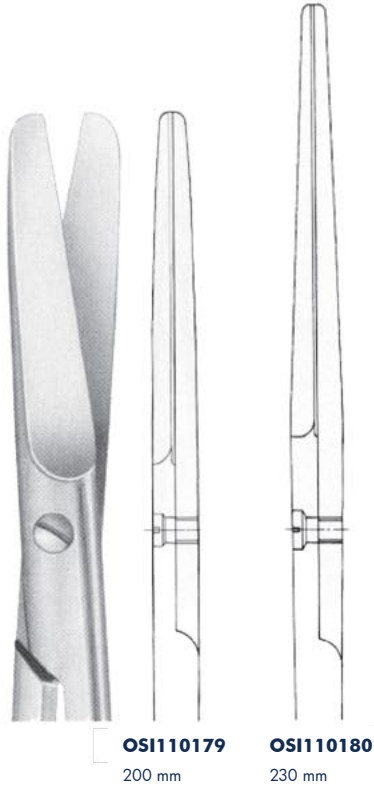

OSI110179 200 mm
OSI110180 230 mm

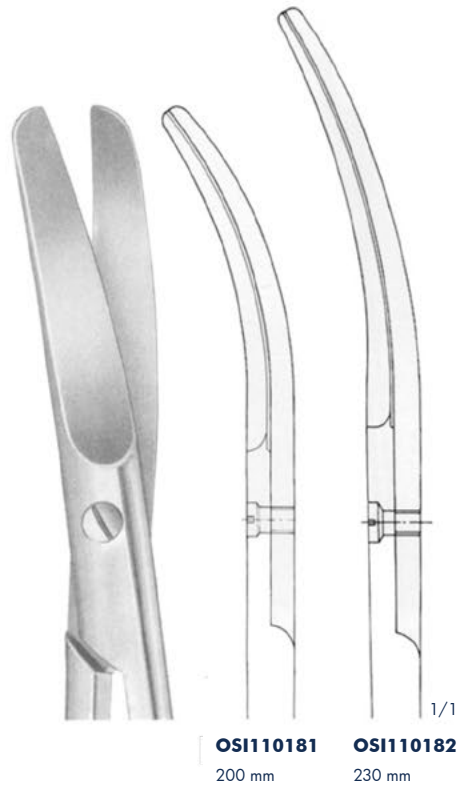

OSI110181 200 mm
OSI110182 230 mm



SIMS
OSI110684 - OSI110687

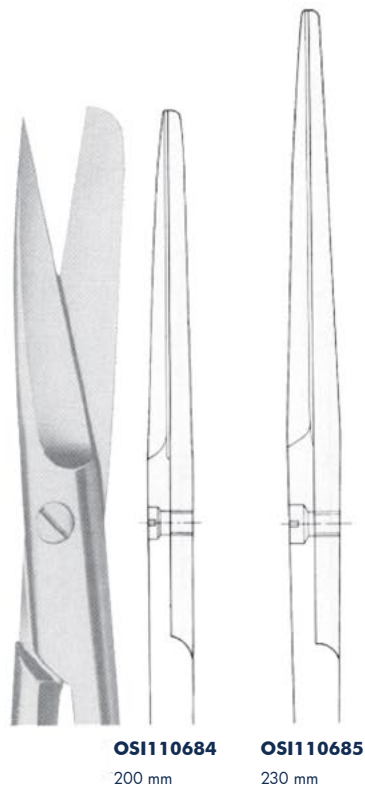

OSI110684 200 mm
OSI110685 230 mm

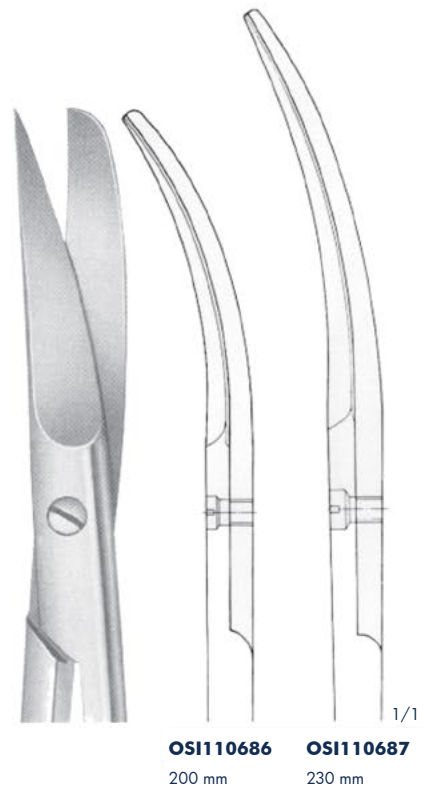

OSI110686 200 mm
OSI110687 230 mm

Scissors for deep Operations and for Gynaecology

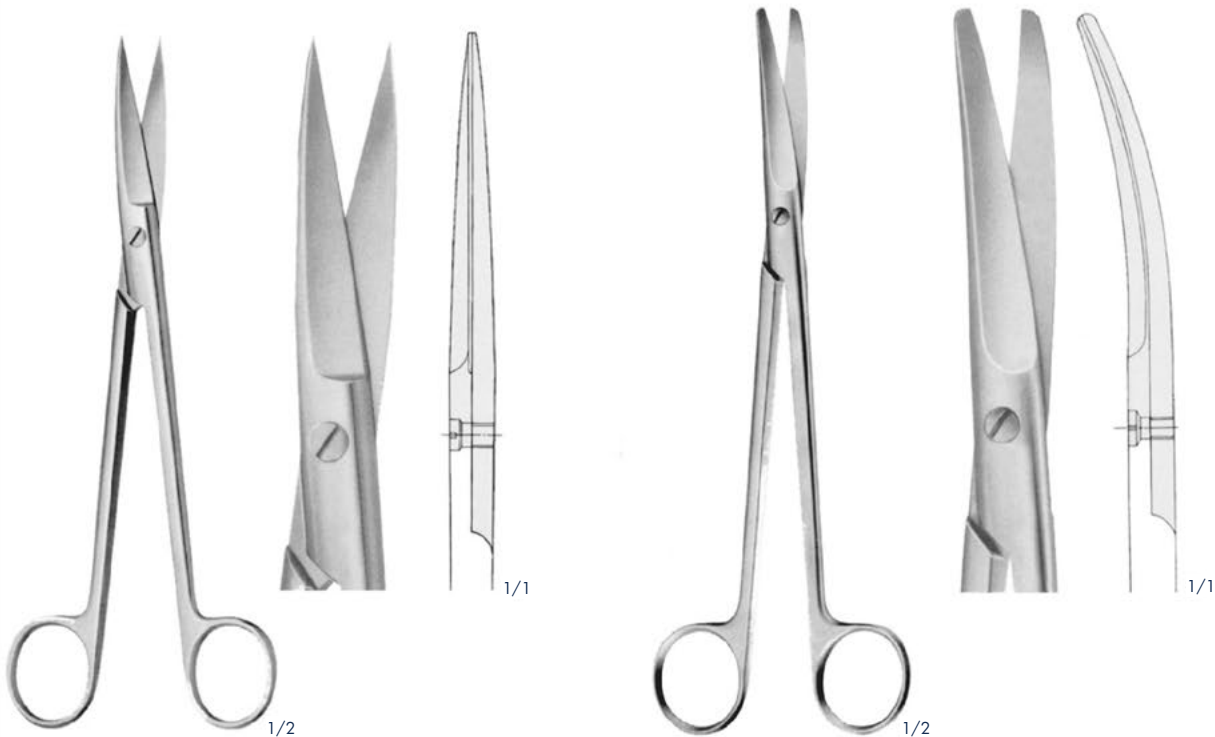

SIMS
OS110688
 200 mm

SIMS
OS110689
 210 mm



WERTHEIM
OS110175 - OS110177

OS110175
 145 mm

OS110176
 200 mm

OS110177
 230 mm

Scissors for deep Operations and for Gynaecology

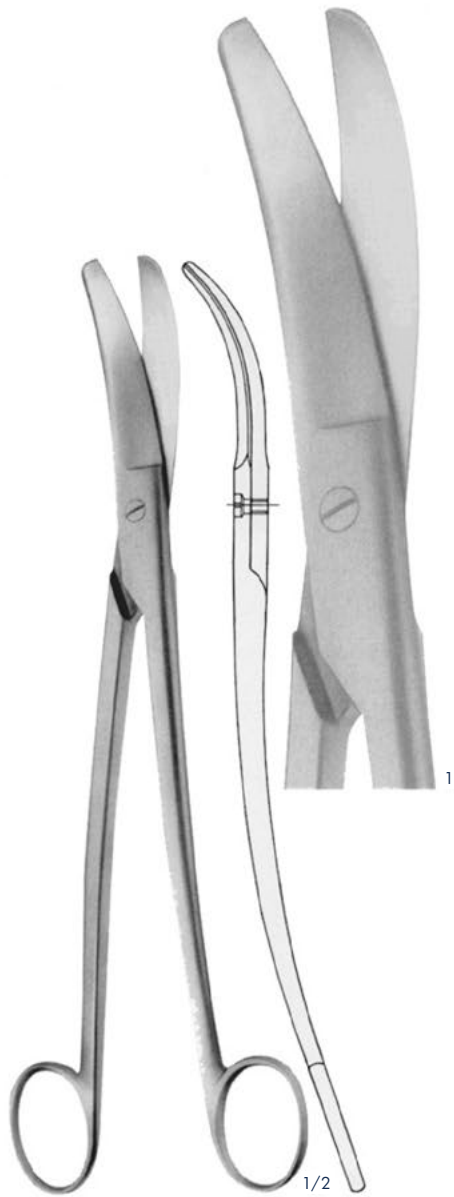

SEIBOLD
OSI110178
Uterine scissors
245 mm



BOZEMANN
OSI110690
Uterine scissors
220 mm

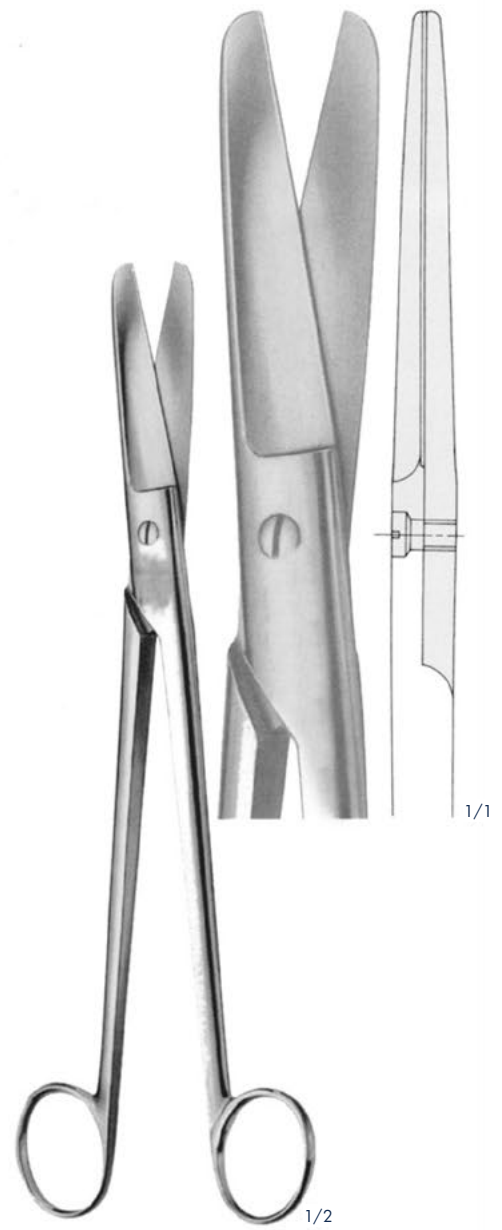

SIMS-SIEBOLD
OSI110691
Uterine scissors
250 mm

Scissors for deep Operations and for Gynaecology



KEIBACK
OSI110692
Parametrium scissors
240 mm

KEIBACK
OSI110693
Parametrium scissors with ball-point,
curved to side
260 mm

Surgical Scissors, heavy pattern (Abdominal Scissors)



OS1110694
Abdominal Scissors
160 mm

OS1110187
Abdominal Scissors
180 mm



OS1110695 - OS1110188
Abdominal scissors

OS1110695
160 mm

OS1110188
180 mm

Scissors for Obstetrics



1/2

SCHUMACHER

OSI110315

Umbilical cord scissors
155 mm



1/1



1/2

OSI110314

Umbilical cord scissors
105 mm



1/1



OSI110696 - OSI110316

Umbilical cord scissors



OSI110696
135 mm

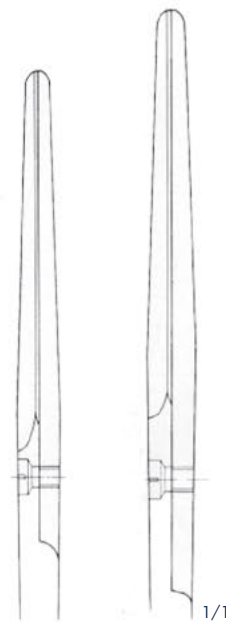

OSI110316
160 mm

1/1

Scissors for Obstetrics



BRAUN-STADLER
OSI110321 - OSI110322
 Episiotomy scissors



OSI110321
 145 mm

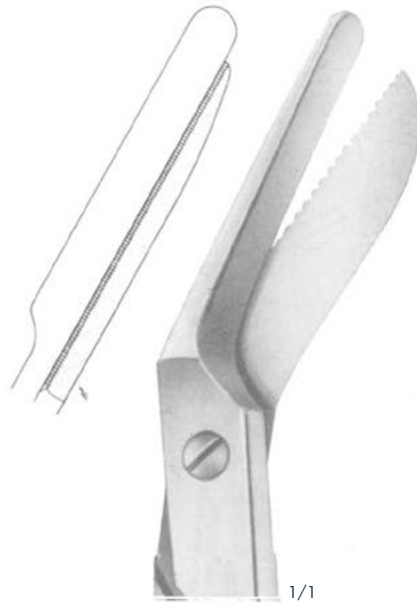

OSI110322
 200 mm



OSI110697
 Episiotomy scissors
 240 mm



DUBOIS
OSI110698 - OSI110699
 Decapitating
 (Embryotomy) scissors
 270 mm

Bowel Scissors, Rectal Scissors

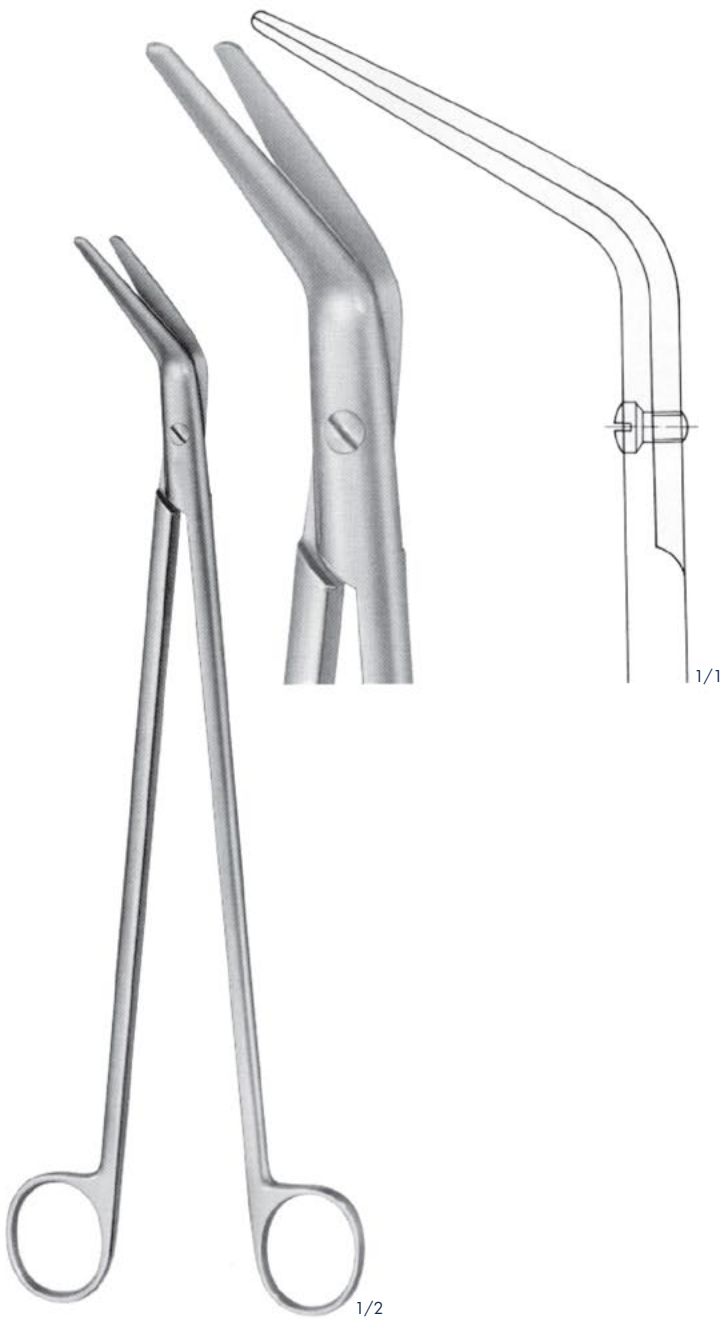

OSI110700

Dissecting scissors
for cutting of the bowel after
suturing with suture device,
60° angled
280 mm

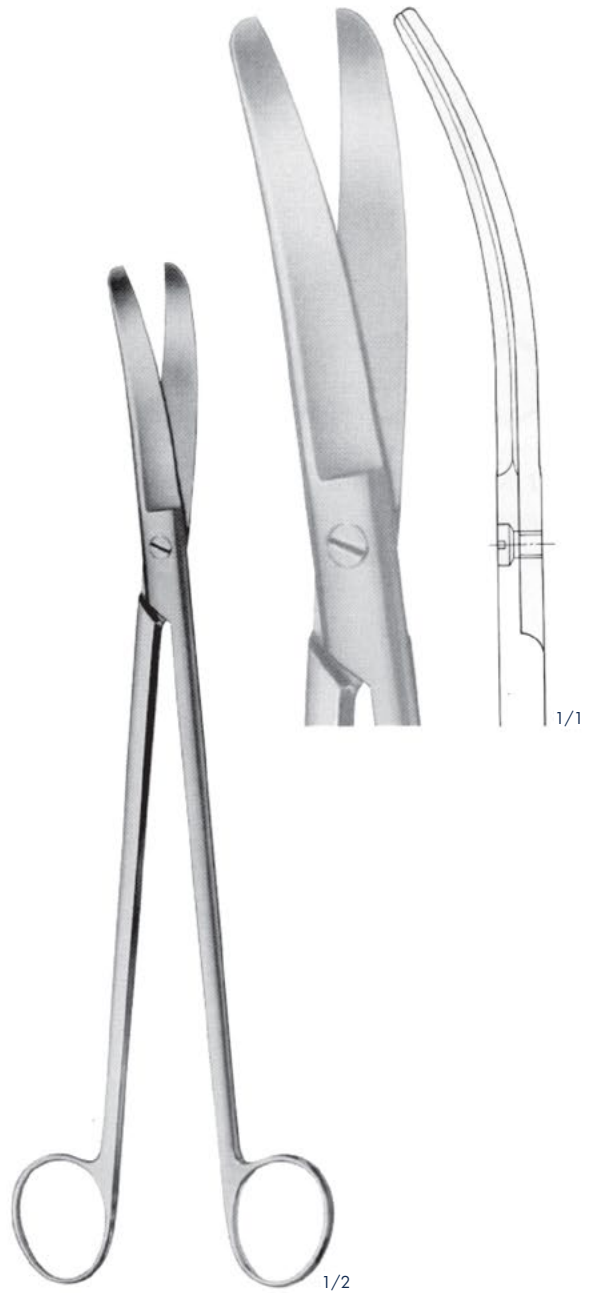

LLOYD-DAVIES (GOLIGHER'S)

OSI110701

Rectal scissors
270 mm

Rectal Scissors

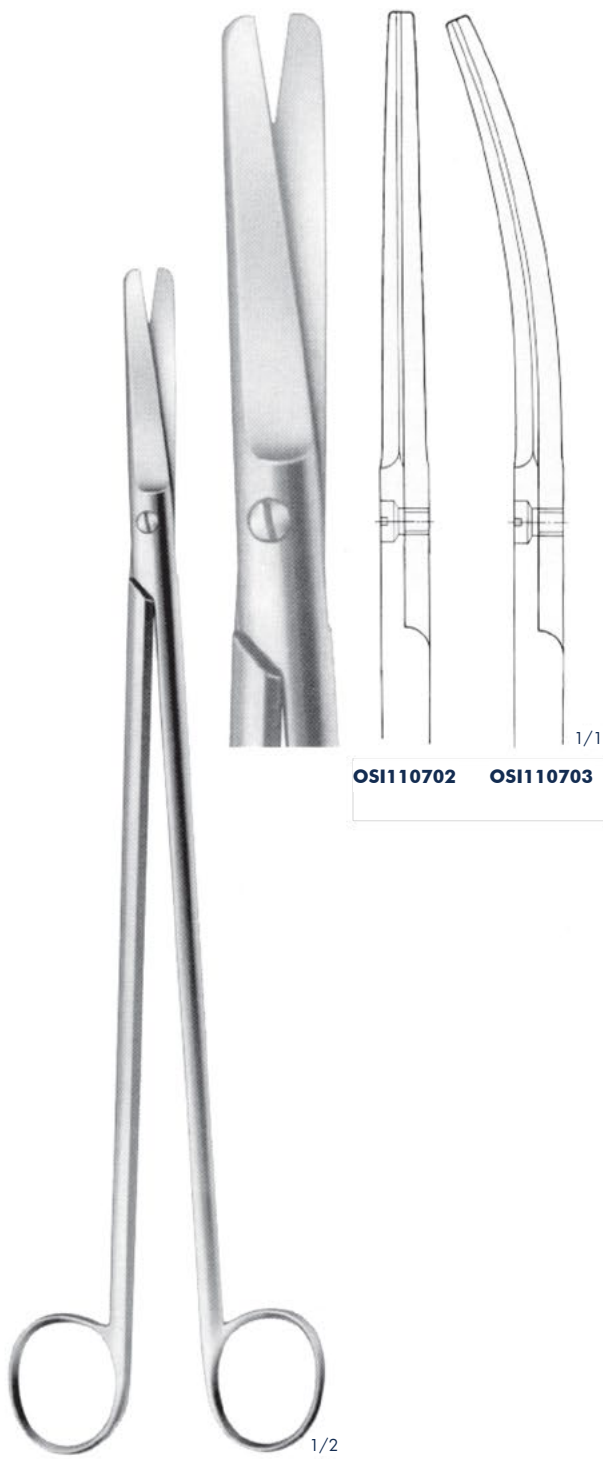

OSI110702 **OSI110703**

STELZNER
OSI110702 - OSI110703
Rectal scissors
310 mm



OSI110704
Rectal scissors
325 mm

Rectal Scissors

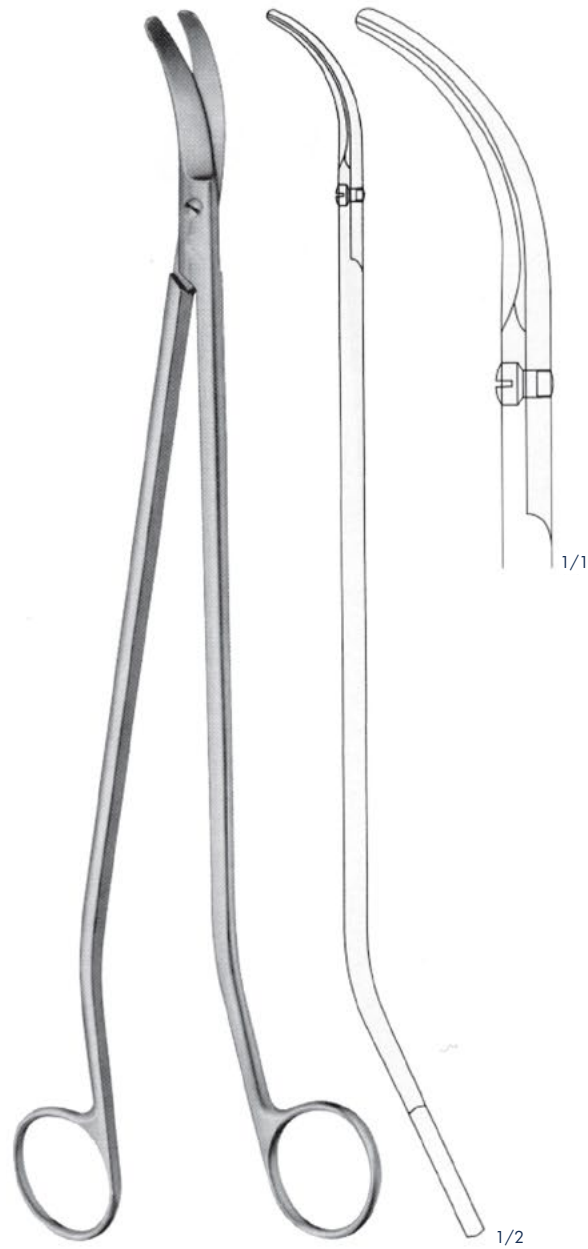

MÜLLER
OSI110705
325 mm

Ligature Scissors



OSI110404 90 mm
OSI110405 115 mm

SPENCER
OSI110404 - OSI110405



LITTAUER
OSI110411
135 mm



NORTHBENT
OSI110706
120 mm



EISELSBERG
OSI110707
115 mm

Wire - and Plate Scissors

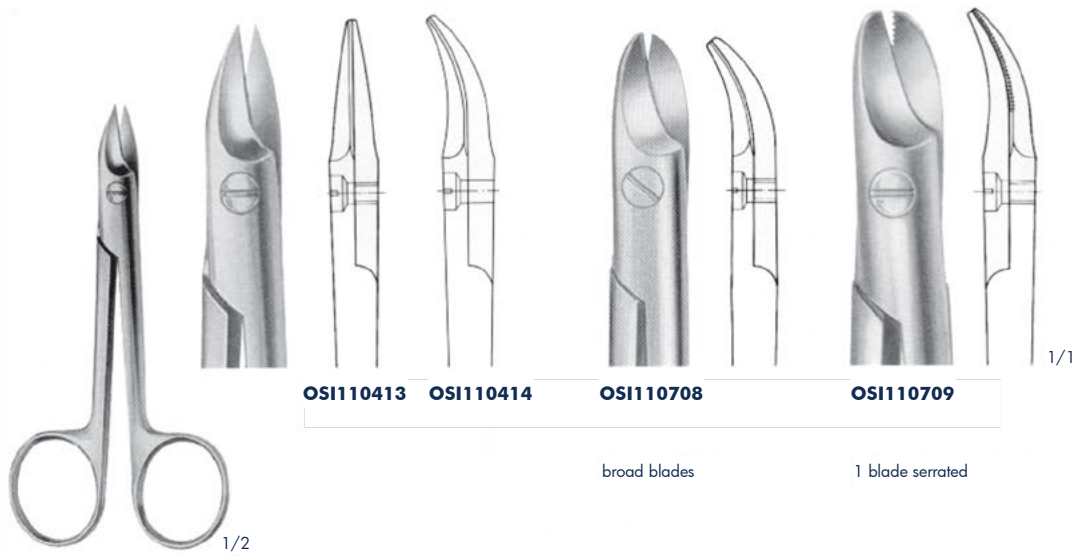

BEEBE
OSI110413 - OSI110414
 110 mm

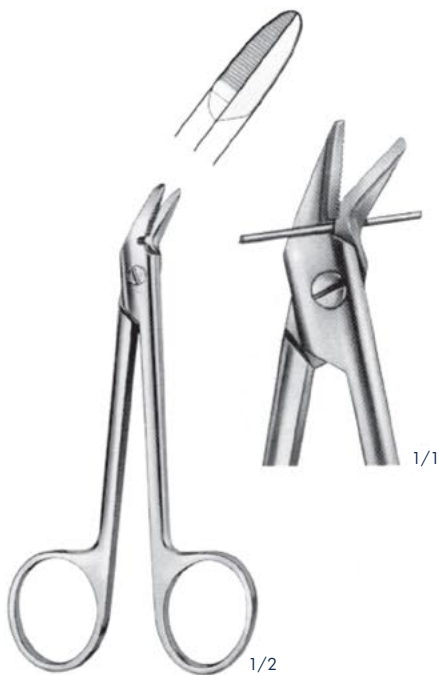

OSI110412
 1 blade serrated
 120 mm

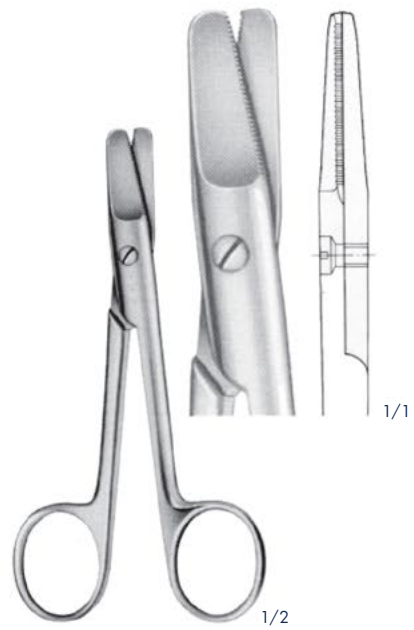

HARVEY
OSI110710
 Blades serrated
 125 mm

Nail Scissors



OS1110466
Nail scissors
90 mm



OS1110467
extra feines Modell
Nail scissors,
especially fine pattern
90 mm



OS1110468
Baby nail scissors
85 mm



Nail scissors

OS1110469
90 mm

OS1110470
90 mm

OS1110471
100 mm

OS1110472
110 mm



Nail scissors

OS1110473
95 mm

OS1110474
95 mm

OS1110475
105 mm

Bandage Scissors

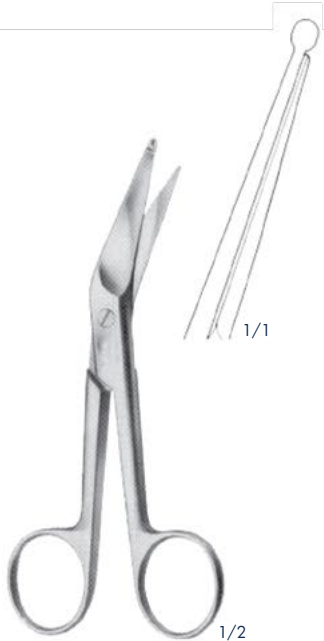

KNOWLES
OS110711
140 mm



KNOWLES
OS110712
145 mm

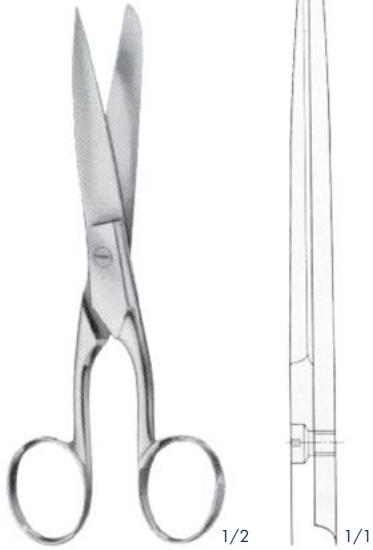

OS110713
150 mm

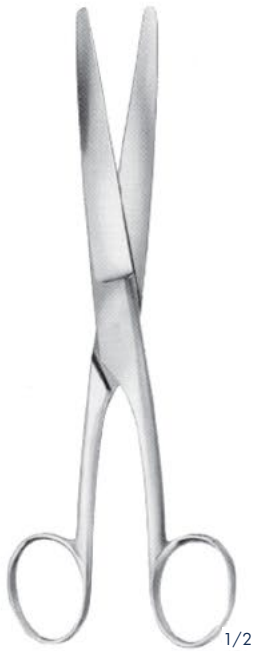

OS110714
180 mm



SMITH
OS110715
180 mm



OS110716
Bandage cutting scissors
180 mm

Bandage - and Cloth Scissors



LISTER

- | | |
|-------------------------|------------------------------|
| OSI110717 black | OSI110721 orange |
| OSI110718 red | OSI110722 pink |
| OSI110719 blue | OSI110723 light green |
| OSI110720 yellow | OSI110724 violet |

Universal bandage- and cloth scissors, with toothed edges, autoclavable up to 143°C (3 bar)
145 mm



- | | |
|-------------------------|------------------------------|
| OSI110725 black | OSI110729 orange |
| OSI110726 red | OSI110730 pink |
| OSI110727 blue | OSI110731 light green |
| OSI110728 yellow | OSI110732 violet |

Universal bandage- and cloth scissors, with toothed edges, autoclavable up to 143°C (3 bar)
180 mm



OSI110733

Nurse's scissors, autoclavable up to 143°C (3 bar)
145 mm

Bandage - and Cloth Scissors



LISTER

OSI180101 - OSI180104



OSI180101
115 mm



OSI180102
140 mm



OSI180103
180 mm



OSI180104
200 mm



LISTER excentric
OSI110734

160 mm



1/1



LISTER

OSI110735 - OSI110736

OSI110735
155 mm



OSI110736
180 mm



1/1

Bandage - Cloth and Plaster Scissors

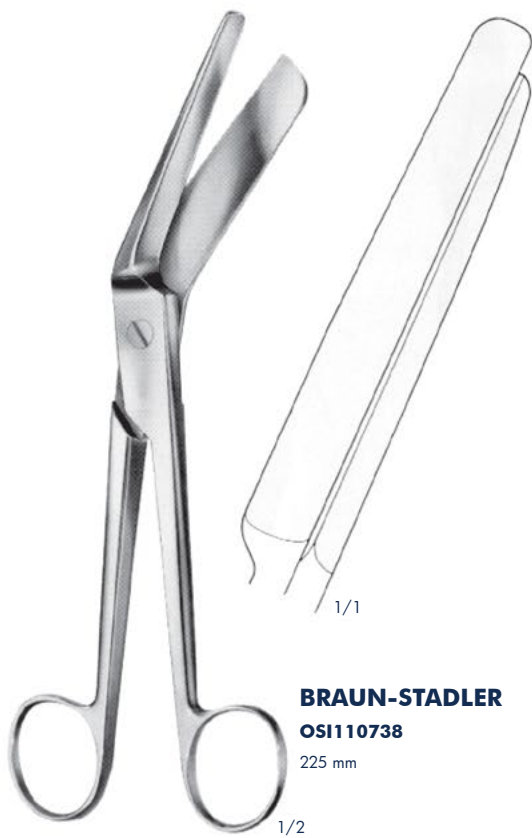

Plaster Scissors

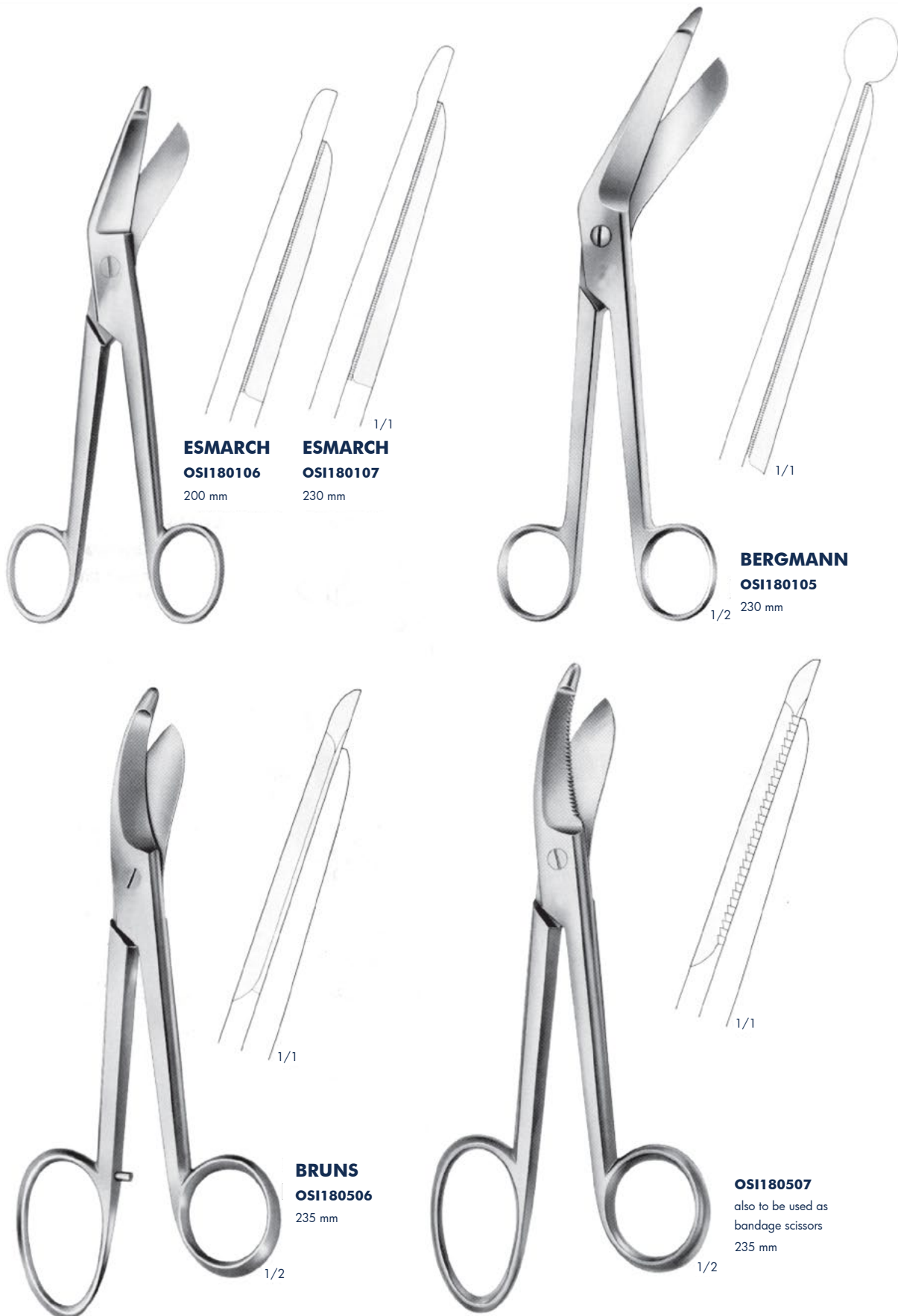

Micro Forceps, Jeweler patterns



OS1120271
110 mm

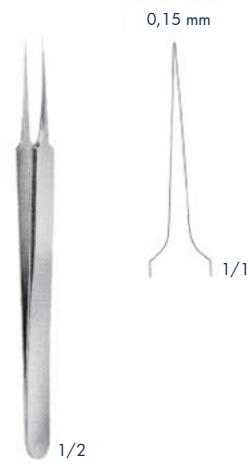

OS1120272
110 mm

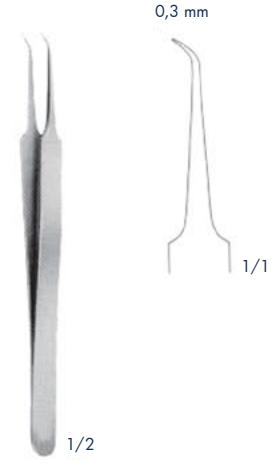

OS1120273
110 mm



OS1120213
115 mm



OS1120274
1 x 2 teeth
115 mm



OS1120214
135 mm

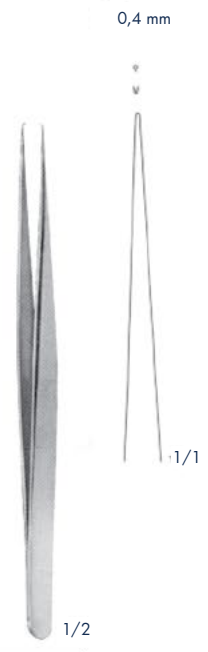

OS1120275
1 x 2 teeth
135 mm

Micro Suture Tying Forceps

* mit Plateau an den Spitzen
with small platforms at the tips



OSI120276
1 x 2 teeth
95 mm



OSI120277
120 mm



VISE
OSI120278
135 mm



VISE
OSI120279
135 mm



LAZAR
OSI120280
155 mm



LAZAR
OSI120281
155 mm



OSI120282
185 mm



AUSTIN
OSI120139
140 mm

MÜLLER Micro Forceps with light weight plastic handle



Müller micro instruments with new, light plastic profile

- The new light plastic profile increases the grip surface, thus guaranteeing an uncramped hand position and providing enhanced sensitivity.
- The round grip cross-section permits easy and uniform turning of the instrument. This extends the application and working areas.
- The easy-grip studded profile guarantees a secure hold for all movements.
- Development in Accordance with ergonomic criteria and the low weight of the new plastic grips are factors which create the preconditions for fatigue-free working and optimum handling.

0,15 mm 0,2 mm 0,3 mm

OSI120283 OSI120284 OSI120285

1/2

MÜLLER
OSI120283 - OSI120285
Handle colour: brown
110 mm

0,5 mm

1/1

1 x 2 teeth

1/2

MÜLLER
OSI120286
Handle colour: black
110 mm

OSI120287 OSI120288

Diam. of ring
1,2 mm

triangular,
1,2 mm wide

1/2

MÜLLER
OSI120287 - OSI120288
Handle colour: grey
110 mm

0,3 mm 0,4 mm

1/1 1/1

OSI120289 OSI120290

with plateau

1/2

MÜLLER
OSI120289 - OSI120290
Handle colour: brown
160 mm

0,5 mm

1/1

1 x 2 teeth

1/2

MÜLLER
OSI120291
Handle colour: black
160 mm

1/1

Ring-Ø 1,2 mm

1,2 mm

1/2

MÜLLER
OSI120292
Handle colour: grey
160 mm

Micro Suture Tying Forceps with round handle

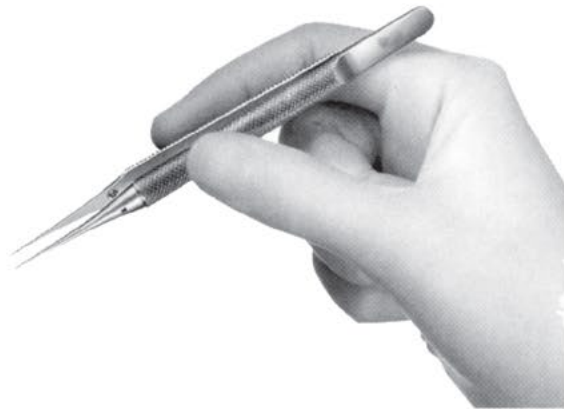

... with round handles
 Round handles allow turning manipulations between the fingers.
 Optimum balance individually for each instrument due to solid or hollowed-out handles.



with small platforms at the tips



OSI120293 - OSI120294

Tips : 0,3 mm
 120 mm

OSI120295 - OSI120296

Tips : 0,3 mm
 150 mm

OSI120297 - OSI120298

Tips : 0,5 mm
 180 mm

Ligature Forceps, Micro Forceps (light patterns)



YASARGIL
OS1120299
Ligature Forceps
185 mm



OSI120300 - OSI120301
Micro Forceps
185 mm

Micro Forceps, bayonet - Shaped



... with YASARGIL Profile Handles

- According to the length of the instrument there are several bore holes which ensure an equally safe grip in the front, middle or rear of the handle and compared with former patterns the instrument is much more balanced.
- Differing from former patterns, instruments with short working ends have now longer handles and springs thus guaranteeing the best hold.
- The bore holes in the handles allow reliable gripping and holding of the instrument which is of importance for deep surgery.
- Reduction of weight due to the bore holes.



YASARGIL
OSI120302 - OSI120304
 180 mm



YASARGIL
OSI120305 - OSI120306
 200 mm

Micro Forceps, bayonet - Shaped



YASARGIL
OS1120307 - OS1120308
220 mm



YASARGIL
OS1120309 - OS1120310
240 mm

Forceps for Grasping Tissue, Tumors etc.

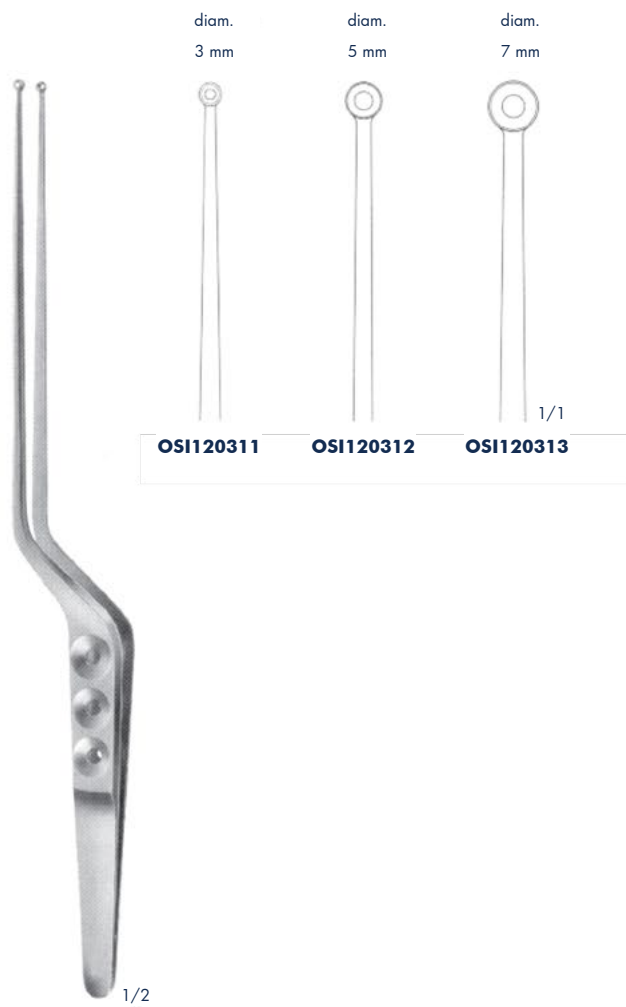

YASARGIL-SAMII
OSI120311 - OSI120313
 Jaws spoon-shaped
 240 mm

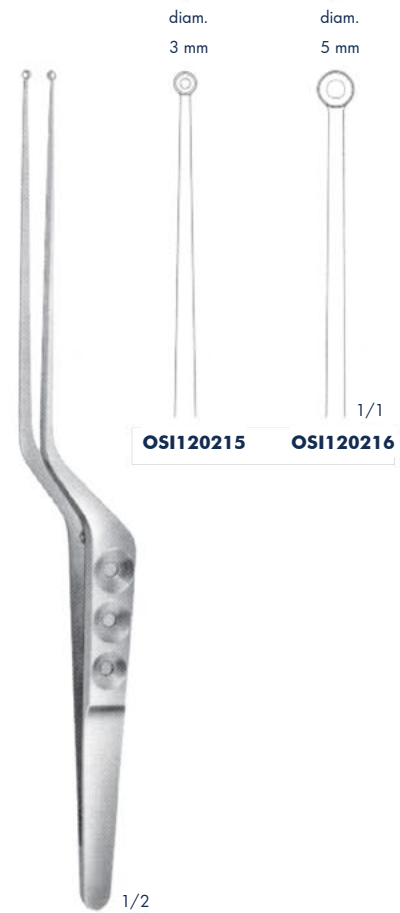

YASARGIL
OSI120215 - OSI120216
 Jaws spoon-shaped
 220 mm

Forceps for Grasping Tissue, Tumors etc.



YASARGIL
OSI120217 - OSI120218
Flat jaws, serrated
220 mm



HEIFETZ
OSI120219 - OSI120220
Curette jaws, toothed
220 mm

Forceps for Grasping Tissue, Tumors etc.



SAMII
OSI120314
Jaws spoon-shaped
230 mm



SAMII
OSI120315
Jaws spoon-shaped
230 mm

Forceps for Grasping Tissue, Tumors etc.

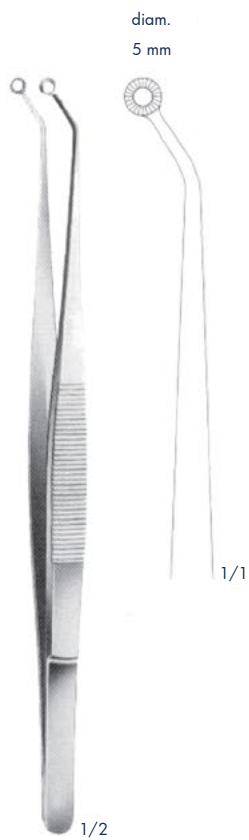

HUNT
OSI120316
Tumor- and vessel forceps
200 mm



HUNT
OSI260521
Tumor- and vessel forceps
200 mm

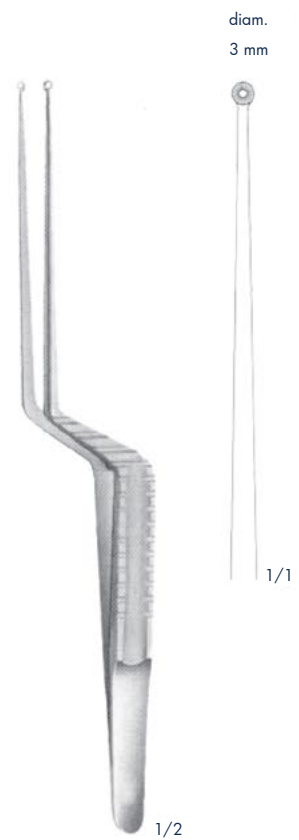

YASARGIL
OSI260522
Tumor- and vessel forceps
200 mm

Delicate Dissecting Forceps



THORPE
OSI120317
 Corneal forceps
 120 mm



MICRO-ADSON
OSI120318
 with plateau
 120 mm



ADSON
OSI120124
 120 mm



MICRO-ADSON
OSI120125
 150 mm



ADSON
OSI120319
 180 mm



JEFFERSON
OSI120320
 180 mm



OSI120321



OSI120322



OSI120323

OSI120321 - OSI120323
 100 mm



BONACCOLTO
OSI120324
 110 mm



OSI120325
 115 mm

Microscopic Forceps



OSI120239 90 mm
OSI120240 105 mm
OSI120241 115 mm
OSI120242 130 mm
OSI120326 145 mm
OSI120244 90 mm
OSI120245 105 mm
OSI120246 115 mm
OSI120247 130 mm
OSI120327 145 mm

OSI120239 - OSI120327

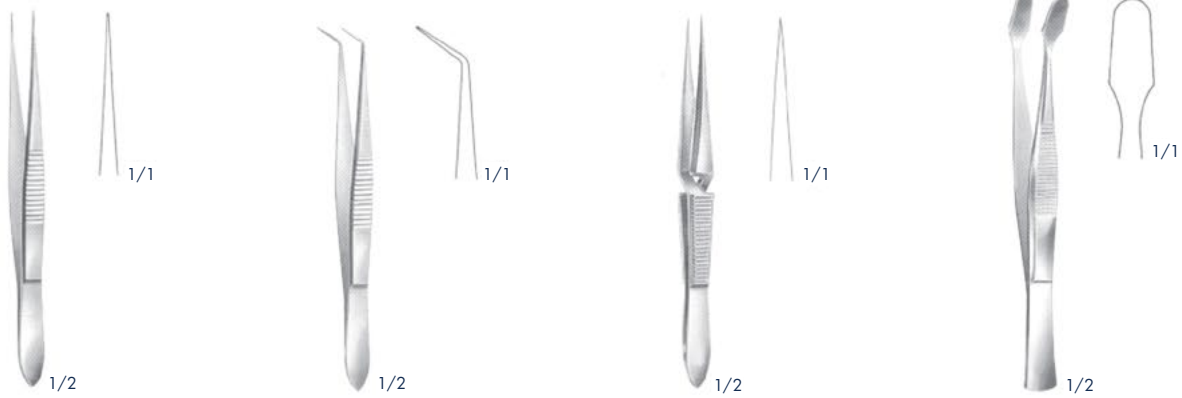

OSI120328
100 mm

OSI120329
100 mm

OSI120330
100 mm

KÜHNE
OSI120331
Cover glass forceps
105 mm

Delicate Dissecting Forceps

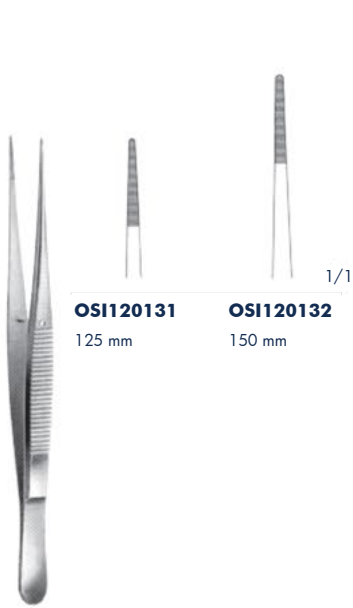

SEMKEN
OSI120131 - OSI120132

OSI120131
125 mm

OSI120132
150 mm



OSI120332
155 mm



GILLIES
OSI120333
150 mm



MC INDOE
OSI120126
150 mm



GERALD
OSI120127 - OSI120334

OSI120127
175 mm

OSI120128
175 mm

OSI120336
230 mm



CAIRNS-DOTT
OSI120335 - OSI120346

OSI120335
175 mm

OSI120336
215 mm

Delicate Dissecting Forceps



CUSHING
OS1120129 - OS1120338

BROPHY
200 mm



OS1120340
200 mm

OS1120341 185 mm
OS1120342 200 mm

OS1120426
200 mm

smooth jaws

Dissecting Forceps

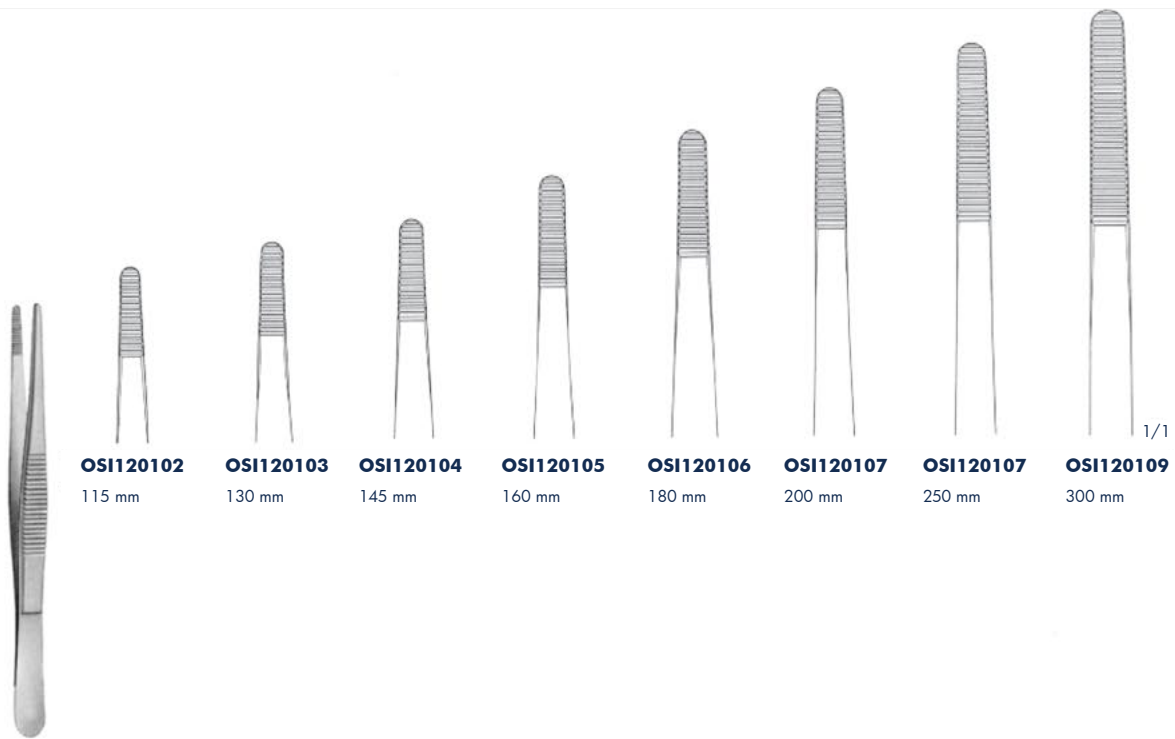

OSI120102
115 mm

OSI120103
130 mm

OSI120104
145 mm

OSI120105
160 mm

OSI120106
180 mm

OSI120107
200 mm

OSI120107
250 mm

OSI120109
300 mm

1/1

STANDARD

OSI120102 - OSI120109

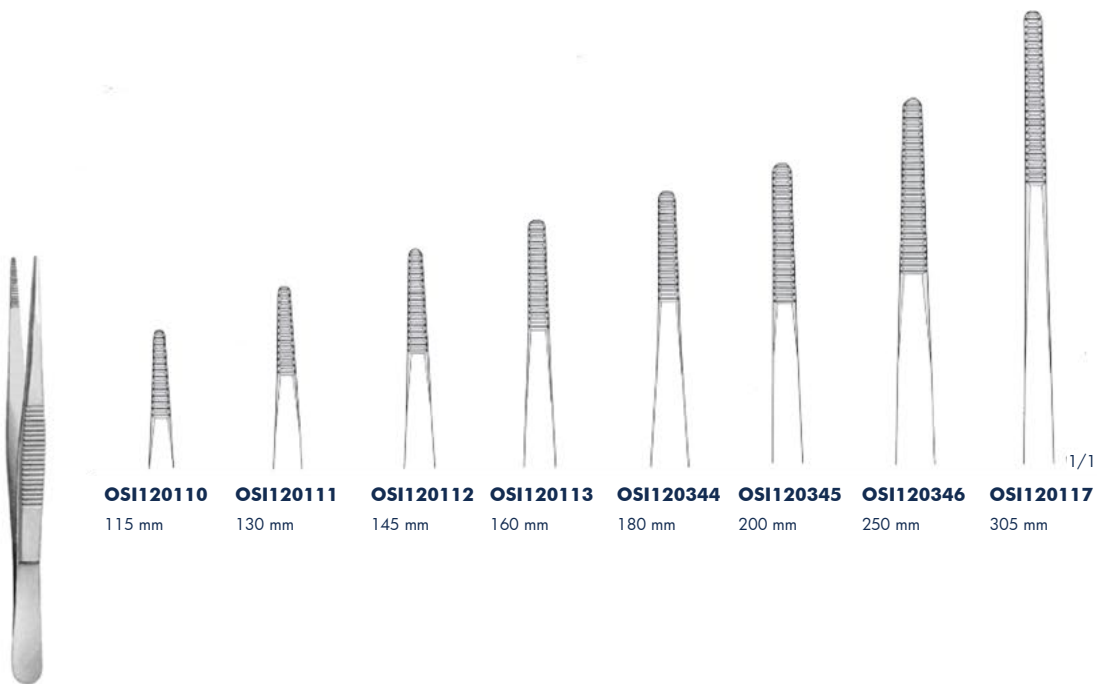

OSI120110
115 mm

OSI120111
130 mm

OSI120112
145 mm

OSI120113
160 mm

OSI120344
180 mm

OSI120345
200 mm

OSI120346
250 mm

OSI120117
305 mm

1/1

OSI120110 - OSI120117

medium

Dissecting Forceps

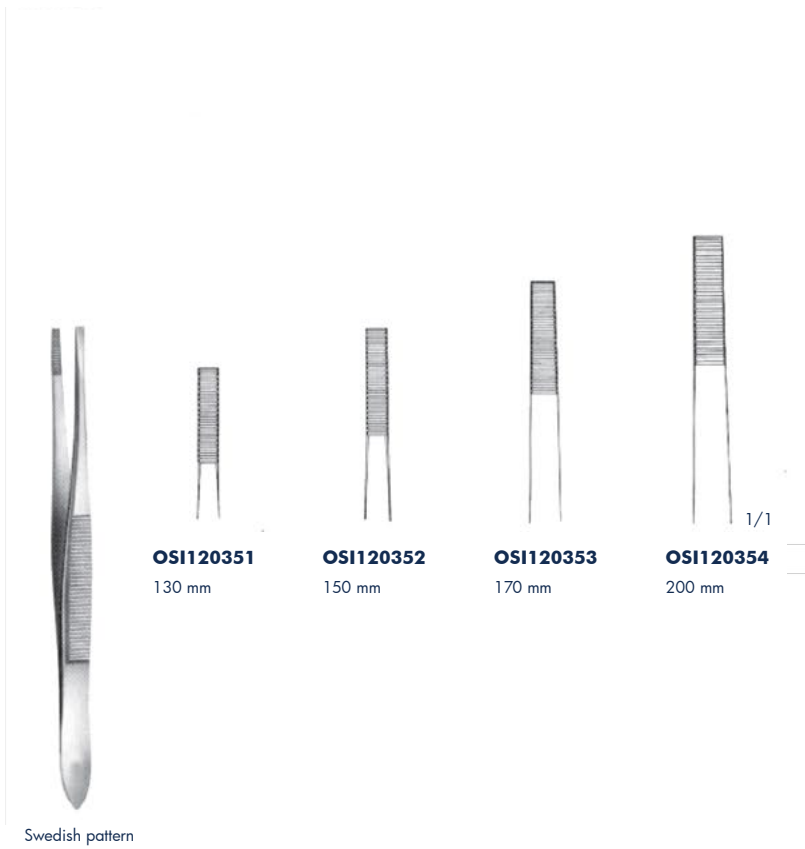
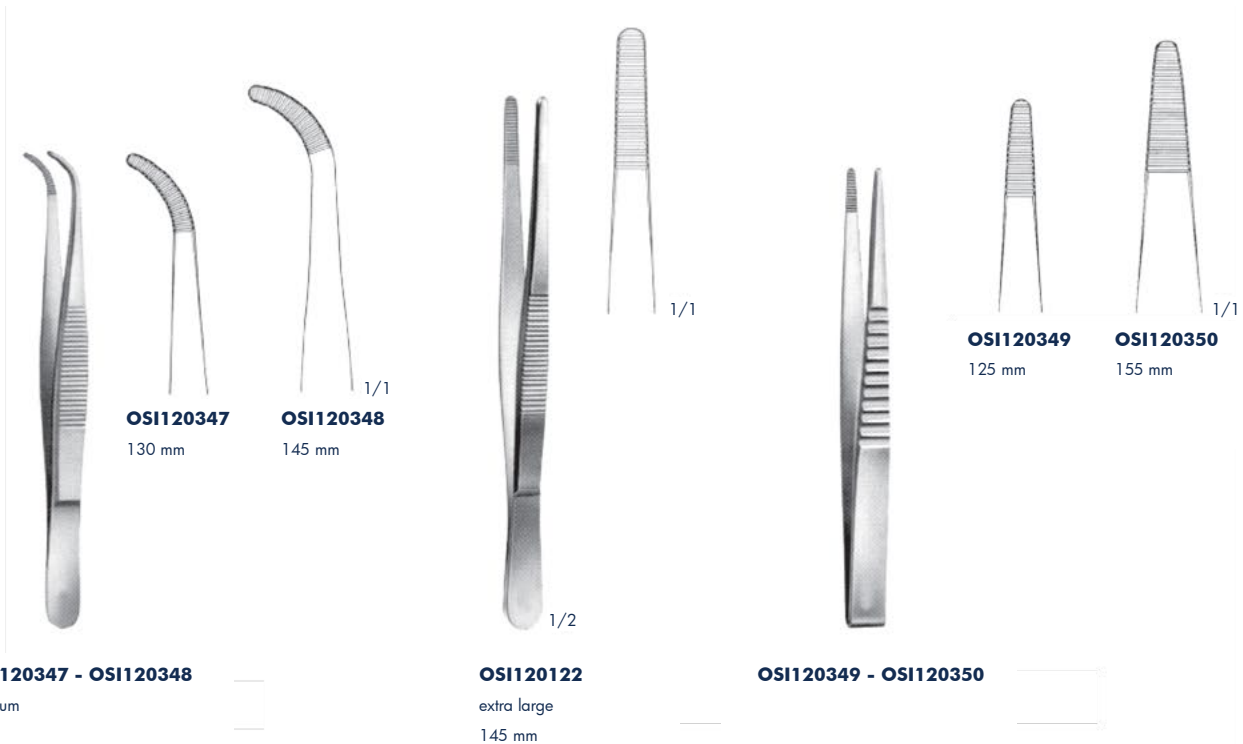

Dissecting Forceps



OCHSNER
OSI120422
Ligature forceps
145 mm



FRICKE
OSI120356
Artery forceps
130 mm



BONNEY
OSI120357
175 mm



RAMSEY
OSI120358
180 mm

Ultra Light Forceps

ATRAUMATIC

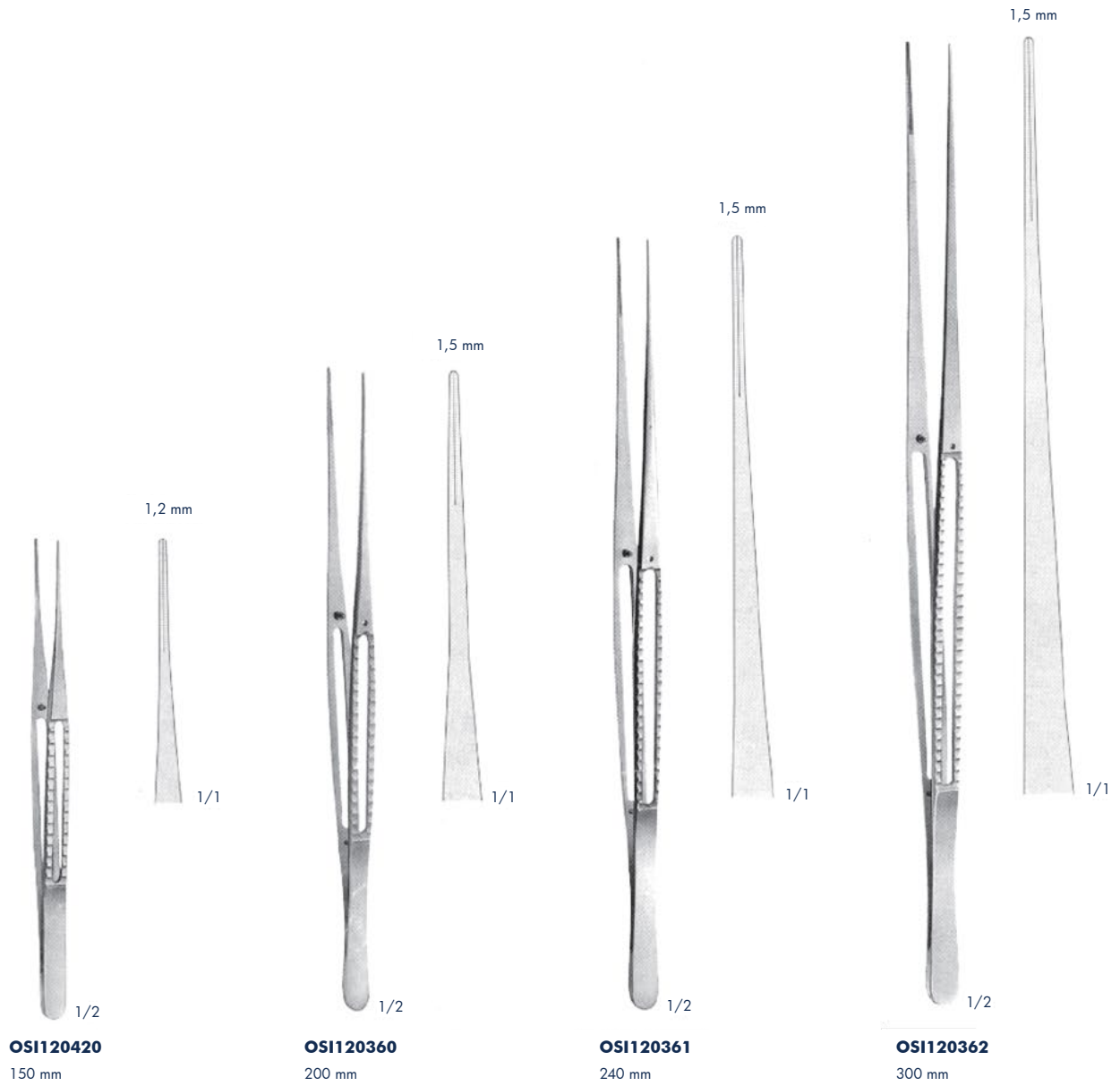

Forceps

ATRAUMATIC



DE BAKEY
OSI200349 195 mm
OSI200350 240 mm

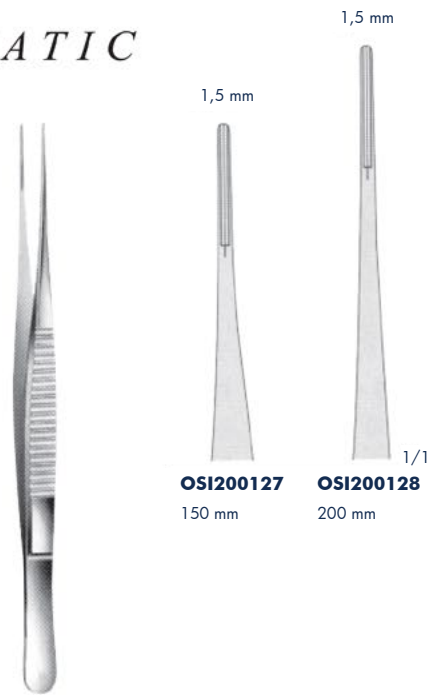

OSI200127 150 mm
OSI200128 200 mm

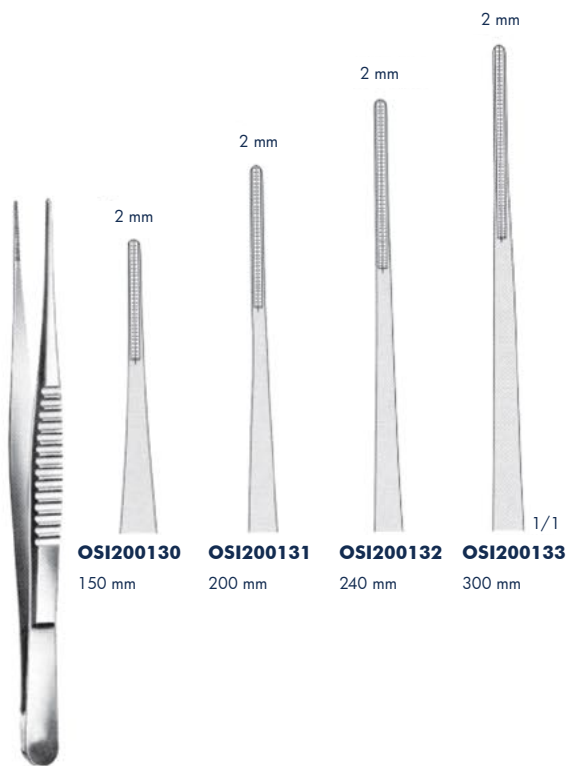

DE BAKEY
OSI200130 - OSI200133

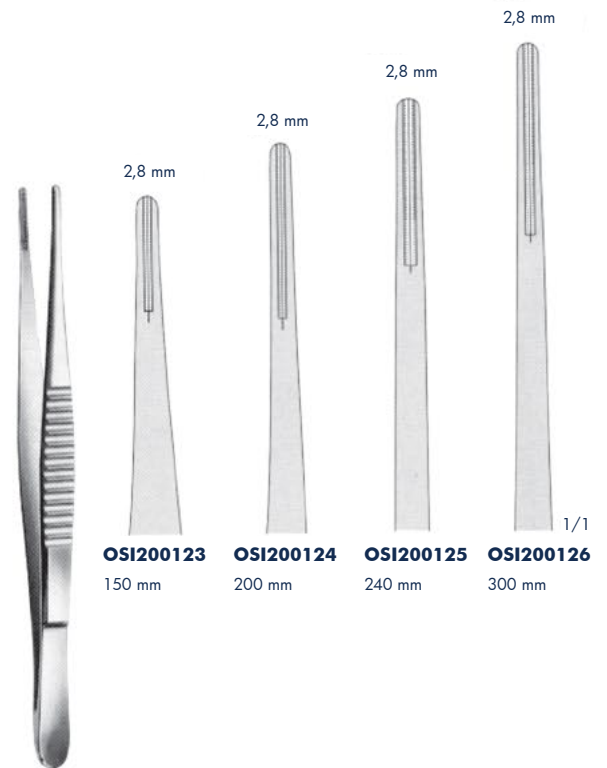

DE BAKEY
OSI200123 - OSI200126

Forceps

ATRAUMATIC



DE BAKEY
OSI200138 - OSI200141



DE BAKEY
OSI200134
150 mm



DE BAKEY
OSI200135
200 mm

Non - traumatic Dissecting Forceps



Dissecting Forceps with carbide inserts
Identification: gold-plated end

Precisely worked out fine structure of carbide inserts -
thus firm and non-traumatic gripping of tissue -
universal in use - long working life

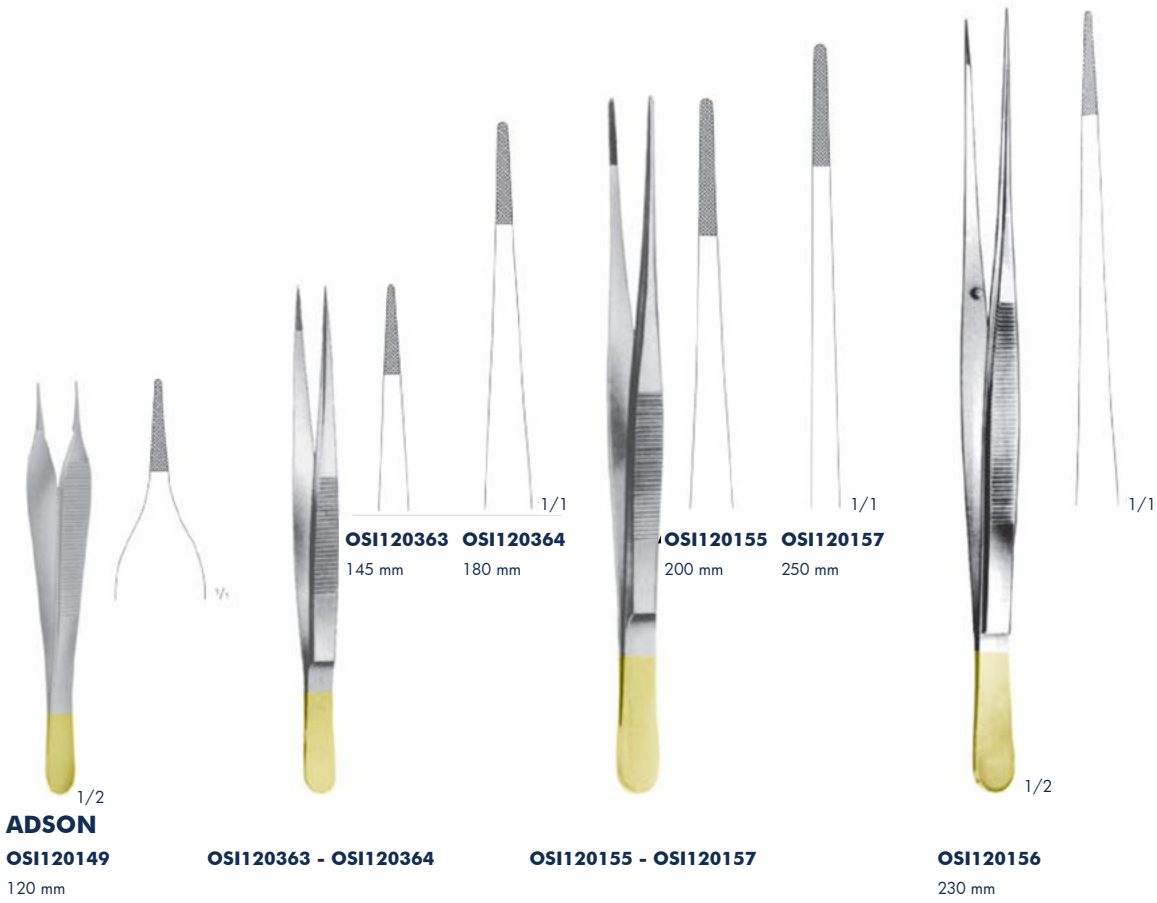

Dissecting Forceps



200 mm

Cushion shaped tip ensures a safe and gentle grasping of the thread.

1/2

OSI120365
Suture forceps



1/1

1/2

FERRIS-SMITH
OSI120455
175 mm



OSI120367
150 mm

OSI120368
230 mm

1/1

WANGENSTEIN
OSI120367 - OSI120368



OSI120369
145 mm

OSI120370
200 mm

OSI120371
250 mm

1/1

1/1

1/1

STANDARD
OSI120369 - OSI120371



1/2

CUSHING
OSI120372
with scraper end
180 mm



1/2

GRUENWALD
OSI120373
185 mm

Forceps, bayonet shaped



LUCAE
OSI250272
140 mm



LUCAE
OSI120374
140 mm
1 x 2 teeth



COTTLE
OSI250651
140 mm
Forceps with jaws toothed and serrated



JANSEN
OSI250273
160 mm



ADSON
OSI120375
175 mm



GRUENWALD
OSI250419
200 mm



OSI120376
160 mm
smooth jaws



OSI120377
160 mm
1 x 2 teeth



OSI120424
185 mm
smooth jaws



OSI260358
200 mm
1 x 2 teeth

Forceps, angular



TROELTSCH
OSI250269
100 mm

TROELTSCH
OSI250270
115 mm

TROELTSCH
OSI120436
115 mm
1 x 2 teeth

WILDE
OSI250271
115 mm

TROELTSCH
OSI120437
120 mm
cross Action

TROELTSCH
OSI250417
140 mm

TROELTSCH
OSI250418
170 mm

LANDOLT
OSI120438
215 mm

Delicate Tissue Forceps



BISHOP-HARMON
OSI120439
85 mm



ST. MARTIN
OSI120343
80 mm

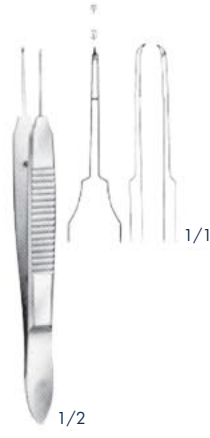

CASTROVIEJO
OSI120440
teeth 0,9 mm
100 mm



CASTROVIEJO
OSI120425
teeth 0,5 mm
100 mm



ELSCHMIG
OSI120441
110 mm



GILL
OSI120442
75 mm

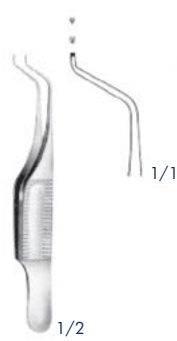

GILL-HESS
OSI120443
75 mm



HESS
OSI120444
70 mm

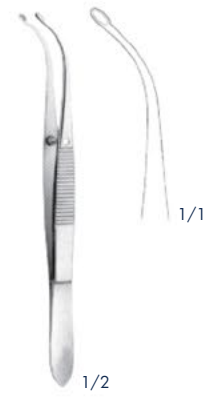

ARRUGA
OSI120445
100 mm

Delicate Tissue Forceps



MICRO-ADSON-BIEMER
OSI120446
 Teeth in oblique position
 120 mm



MICRO-ADSON
OSI120205
 120 mm



ADSON
OSI120188
 120 mm

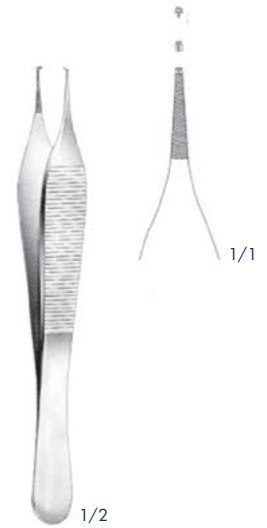

ADSON
OSI120204
 with plateau
 120 mm

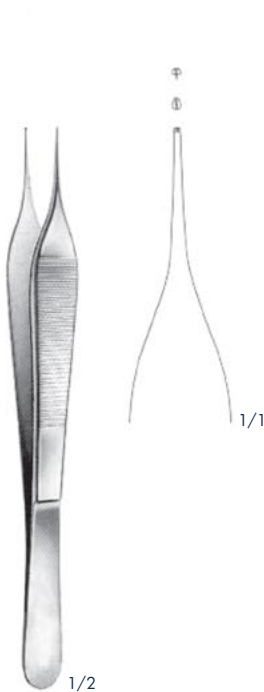

MICRO-ADSON
OSI120189
 150 mm



ADSON
OSI120421
 1 x 2 teeth
 180 mm



JEFFERSON
OSI120447
 1 x 2 teeth
 180 mm

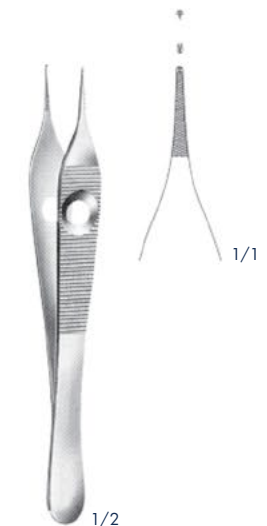

ADSON
OSI120448
 120 mm

Delicate Tissue Forceps



ADSON
OSI120355
with plateau
120 mm

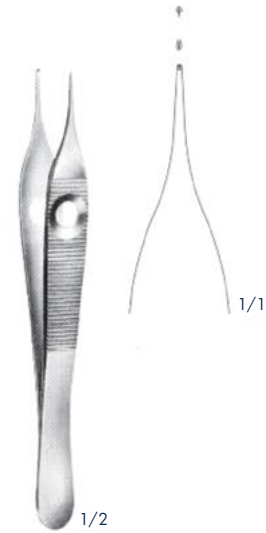

ADSON
OSI120449
120 mm



ADSON
OSI120450
120 mm

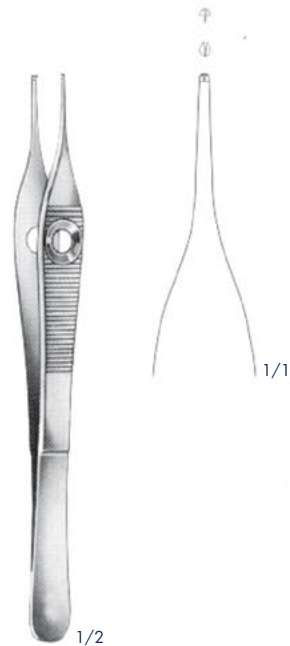

ADSON
OSI120423
150 mm

Tissue Forceps



ADSON-BROWN
OSI120203
 Sharp tissue forceps
 120 mm

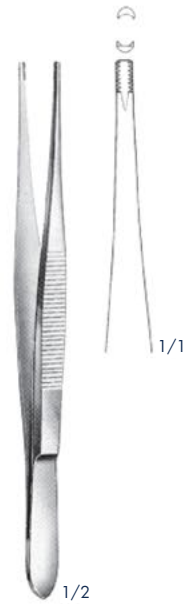

BROWN
OSI120359
 150 mm

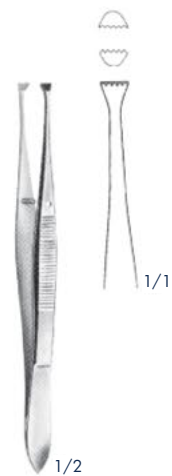

GRAEFFE
OSI120429
 110 mm



GRAEFFE
OSI120451
 with catch
 110 mm

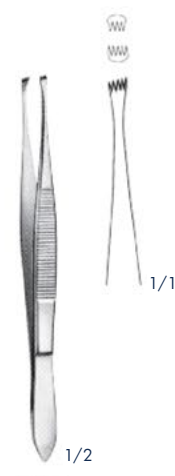

JESS
OSI120452
 110 mm

Delicate Tissue Forceps



OSI120428 - OSI120454
 very delicate
 100 mm

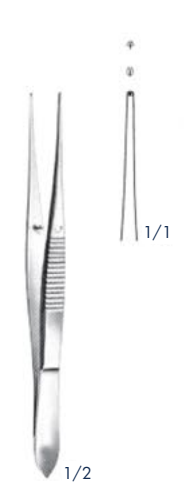

OSI120366
 100 mm

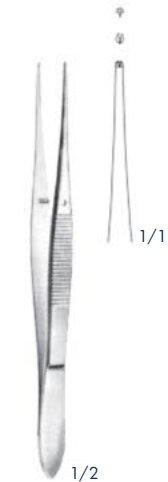

OSI120456
 110 mm

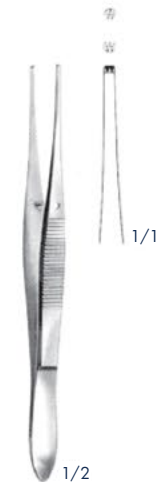

OSI120457
 2 x 3 teeth
 110 mm



SEMKEN
OSI120144 - OSI120199

OSI120144 125 mm
OSI120458 125 mm
OSI120199 150 mm

2 x 3 teeth

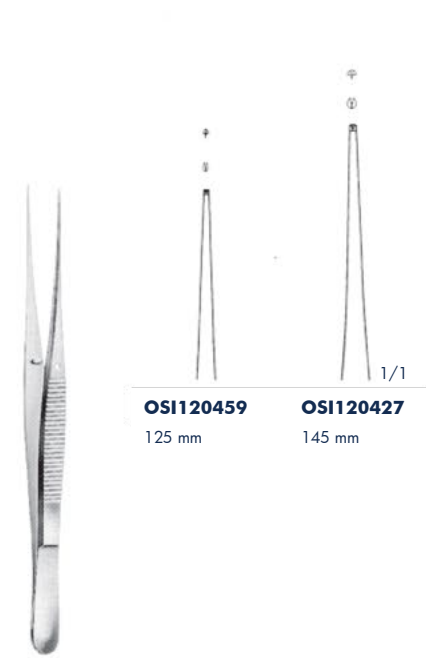

SEMKEN
OSI120459 - OSI120427

OSI120459 125 mm
OSI120427 145 mm

Delicate Tissue Forceps



MC INDOE
OSI120460
delicate



GILLIES
OSI120190
delicate



GERALD
OSI120191 - OSI120192
delicate



WAUGH
OSI120200 - OSI120463
delicate



BROPHY
OSI120464



OSI120465

Tissue Forceps

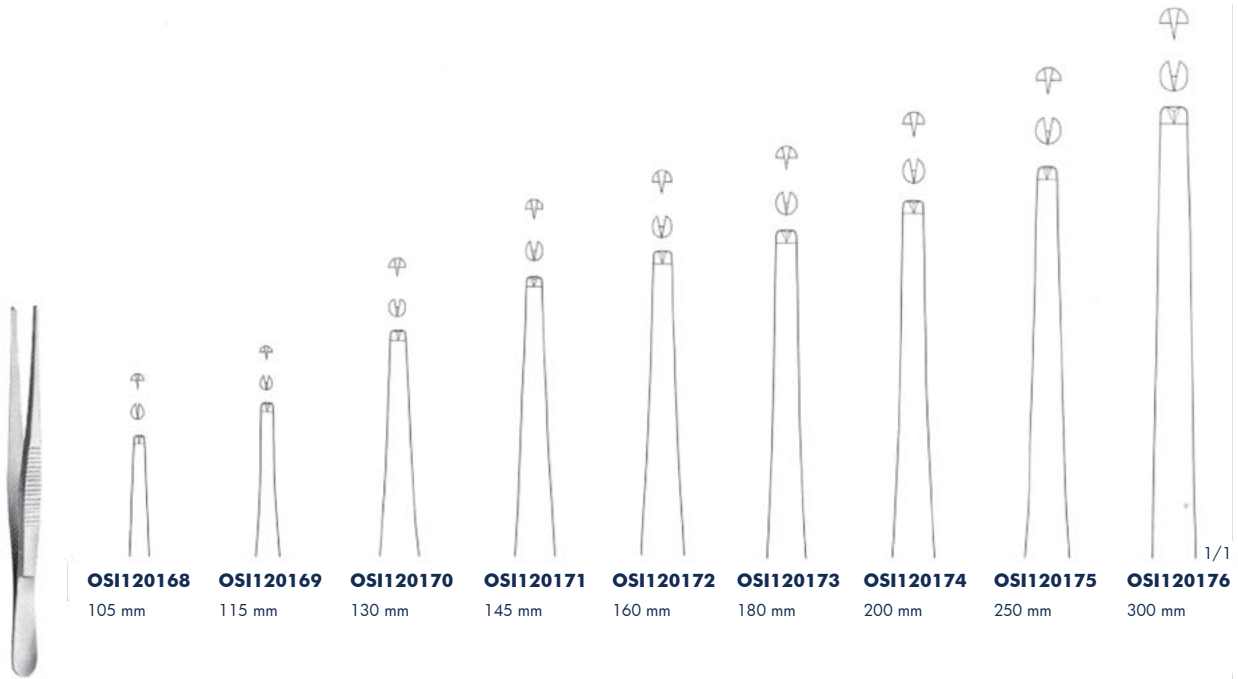

STANDARD
OSI120168 - OSI120176

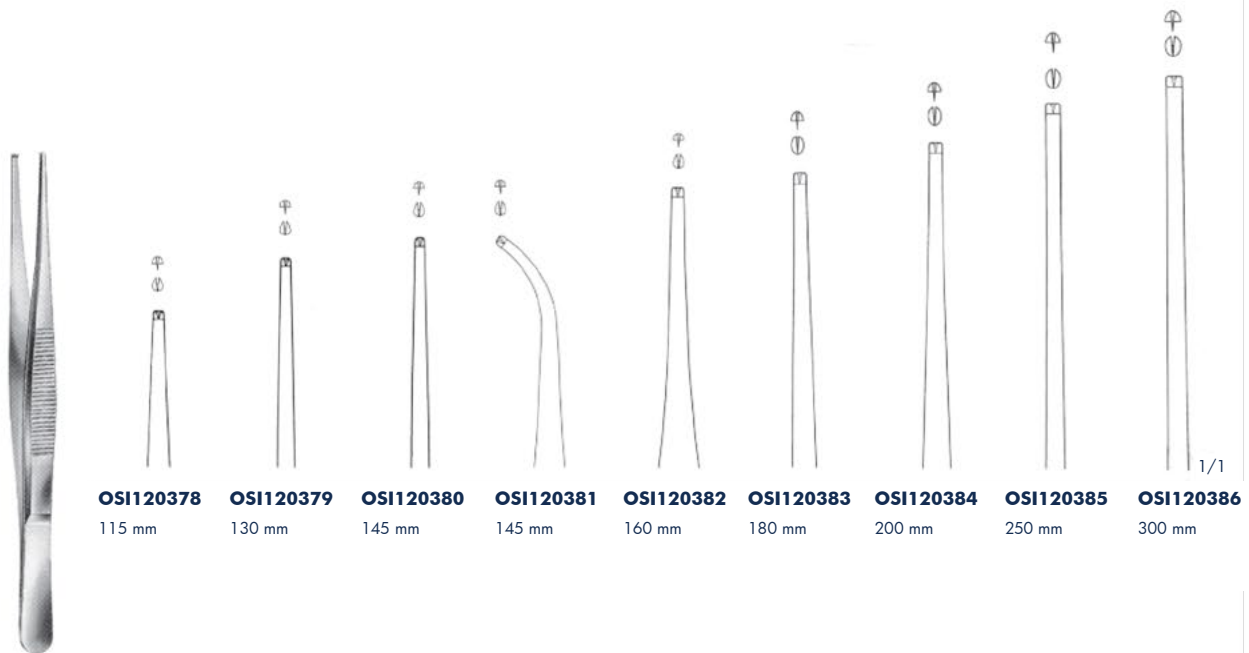

OSI120378 - OSI120386
medium

Tissue Forceps



OSI120387 - OSI120388

OSI120186
heavy pattern

OSI120178 - OSI120182
2 x 3 teeth

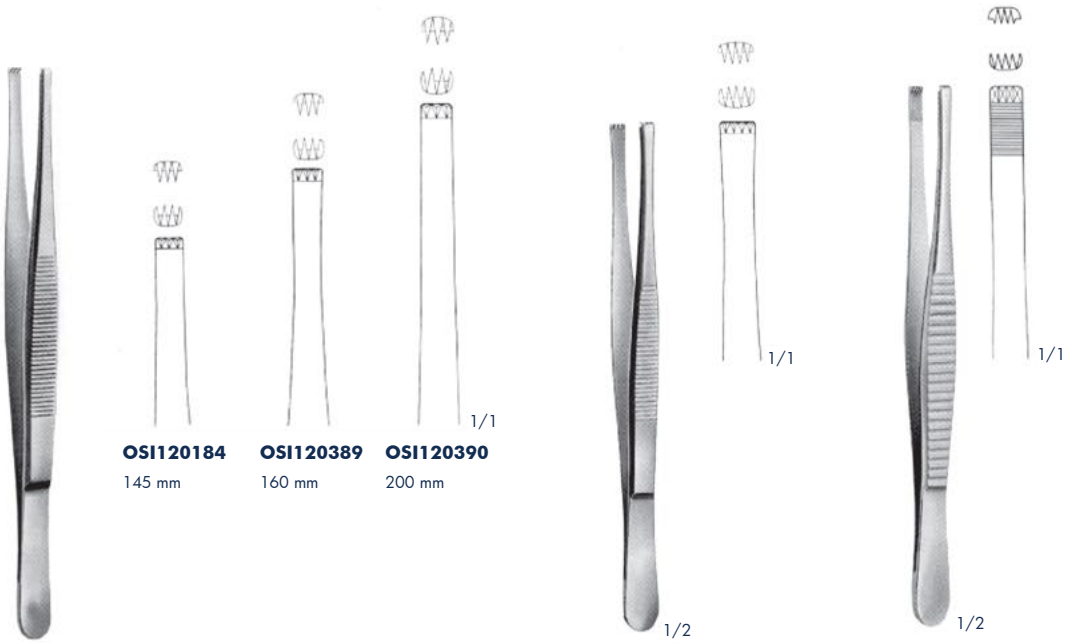

OSI120184 - OSI120390
3 x 4 teeth

OSI120185
4 x 5 teeth
145 mm

OFFICER
OSI120391
4 x 5 teeth
150 mm

Tissue Forceps



LANE

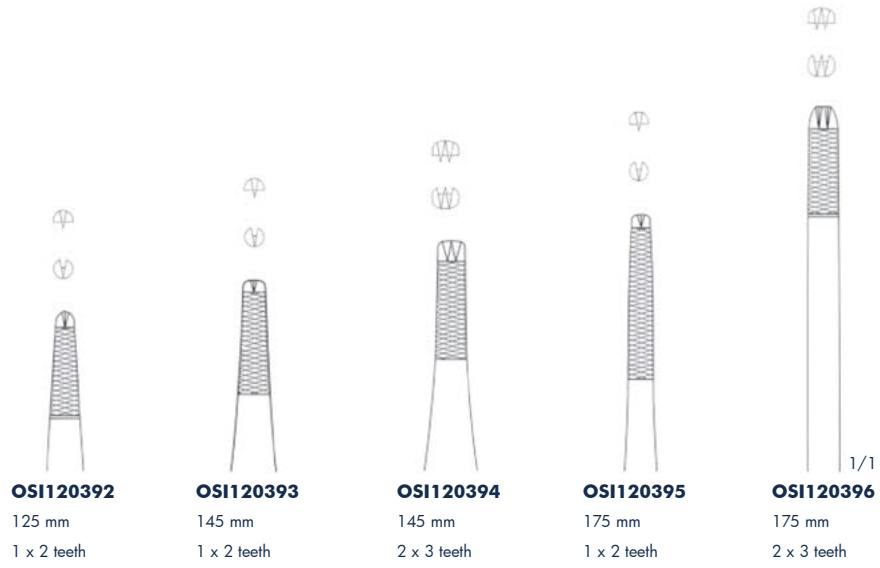

OS1120392
125 mm
1 x 2 teeth

OS1120393
145 mm
1 x 2 teeth

OS1120394
145 mm
2 x 3 teeth

OS1120395
175 mm
1 x 2 teeth

OS1120396
175 mm
2 x 3 teeth



TREVES
OS1120397 - OS1120398



OS1120397
125 mm
1 x 2 teeth



OS1120398
150 mm
1 x 2 teeth



BONNEY
OS1120399
175 mm



Tissue Forceps



JACKSON-BURROWS
OSI120400
 140 mm
 1 x 2 teeth



RAMSEY
OSI120401 - OSI120402
 180 mm

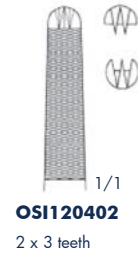
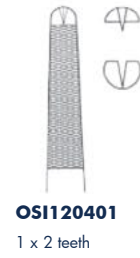

CHARNLEY
OSI120403
 180 mm



STRASSBURGER MODELL
OSI120404 - OSI120405



Tissue Forceps



OSI120406
150 mm



OSI120407
200 mm



1/1

ADLERKREUTZ
OSI120406 - OSI120407
Vascular- and tumor forceps



OSI120408
180 mm



OSI120409
200 mm



OSI120410
250 mm



1/1

STILLE-BARRAYA
OSI120408 - OSI120410
Vascular- and tumor forceps



1/2

RUSS. MODELL
OSI120208
150 mm



1/1



1/2

RUSS. MODELL
OSI120209
200 mm



1/1

Lung Dissecting Forceps, Intestinal Forceps



TUTTLE
OSI120211
 Lung dissecting forceps
 230 mm

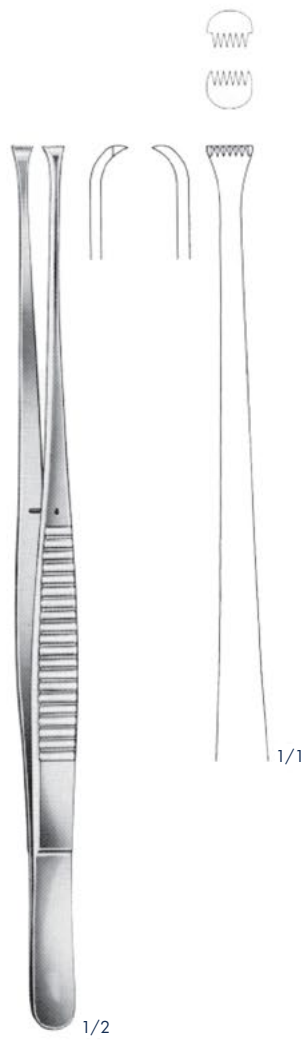

NELSON
OSI120212
 Lung dissecting forceps
 230 mm



DUVAL
OSI120207
 Intestinal forceps
 140 mm



DENIS-BROWNE
OSI230321
 Intestinal forceps
 190 mm

Splinter Forceps

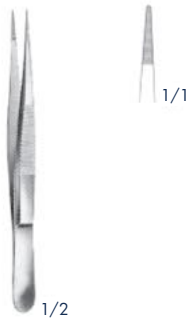

OSI120253
80 mm



FEILCHENFELD
OSI120254 - OSI120256

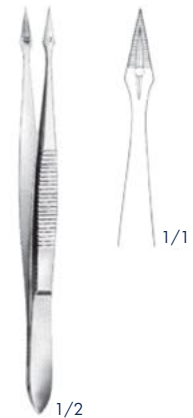

HUNTER
OSI120411
105 mm



STIEGLITZ
OSI120266
140 mm



STIEGLITZ
OSI120267
140 mm



PEET
OSI120268
120 mm

Cilia Forceps



BEER
OSI120263
85 mm



OSI120412
85 mm



OSI120262
85 mm



OSI120261
85 mm

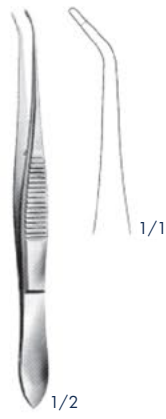

SAUPE
OSI120413
105 mm

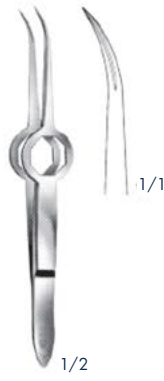

SCHAAF
OSI120260
95 mm



OSI120414
105 mm

Sponge - and Dressing Forceps



BRYANT
OSI140132
 130 mm



LISTER
OSI140133 - OSI140135
 Sinus forceps

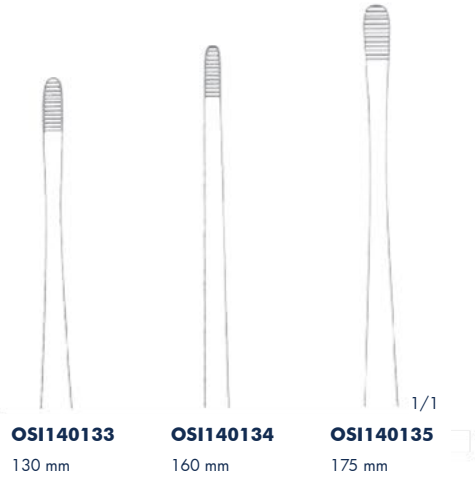

OSI140133
 130 mm

OSI140134
 160 mm

OSI140135
 175 mm



OSI140136
 without ratchet
 145 mm



OSI140137
 with ratchet
 145 mm



OSI140138
 175 mm

Sponge - and Dressing Forceps

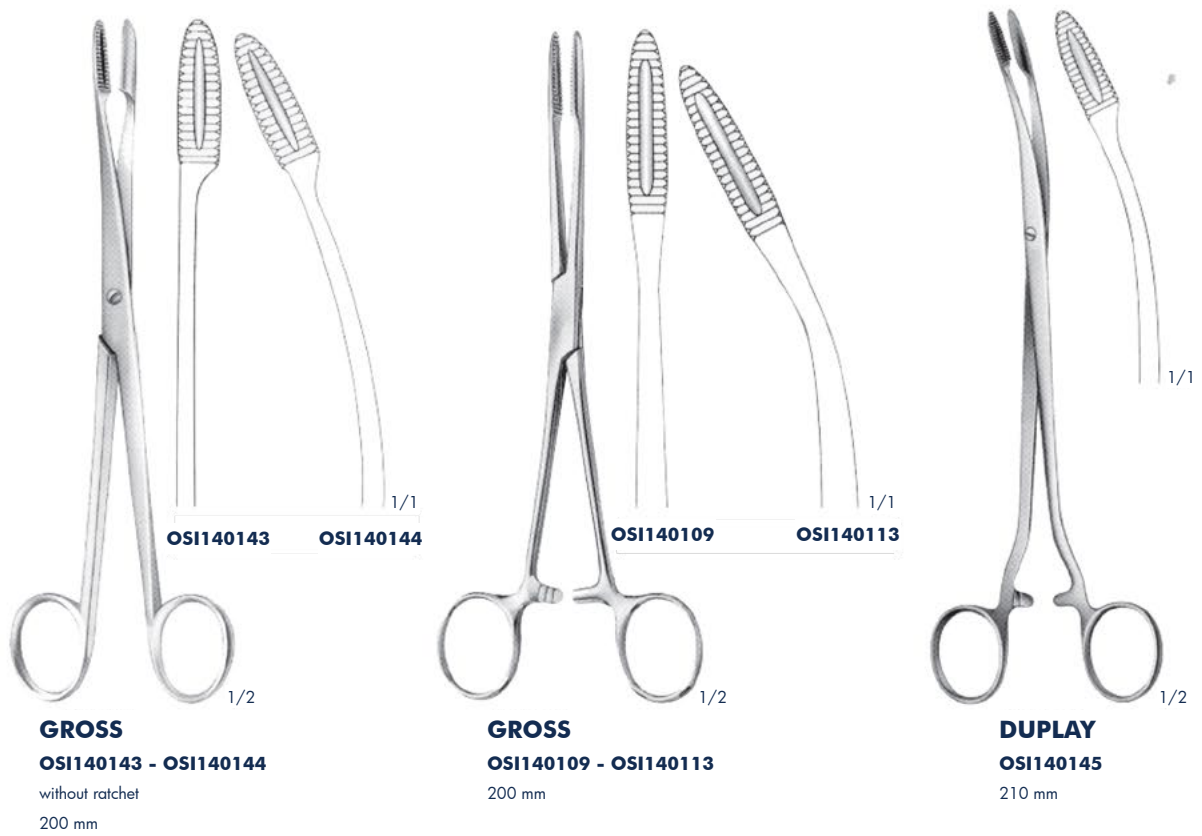

Sponge - Dressing -and Washing Forceps



Sponge - and Dressing Forceps

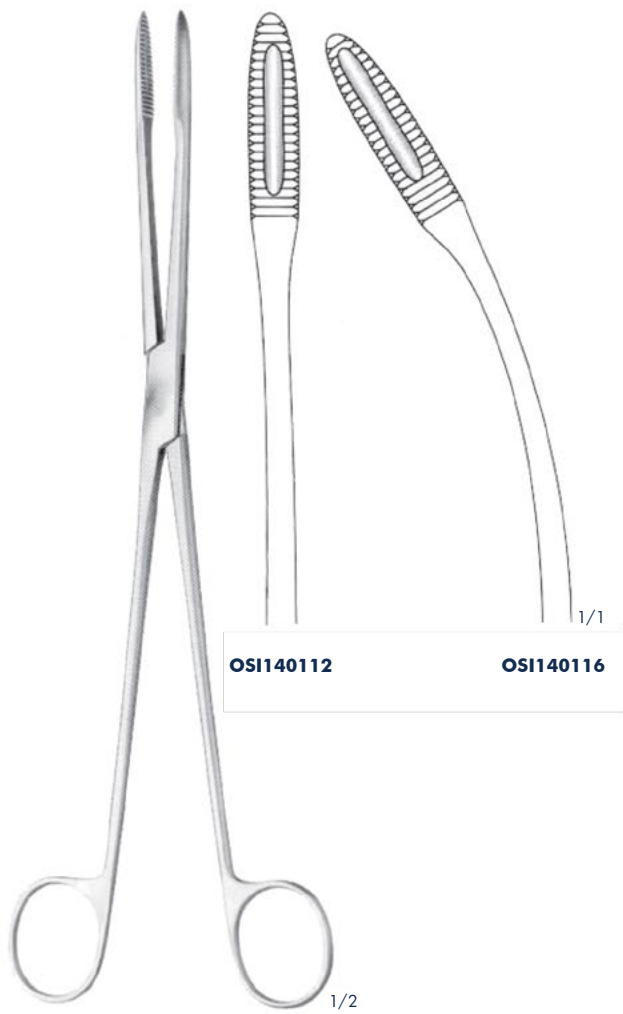

MAIER
OSI140112 - OSI140116
without ratchet
265 mm

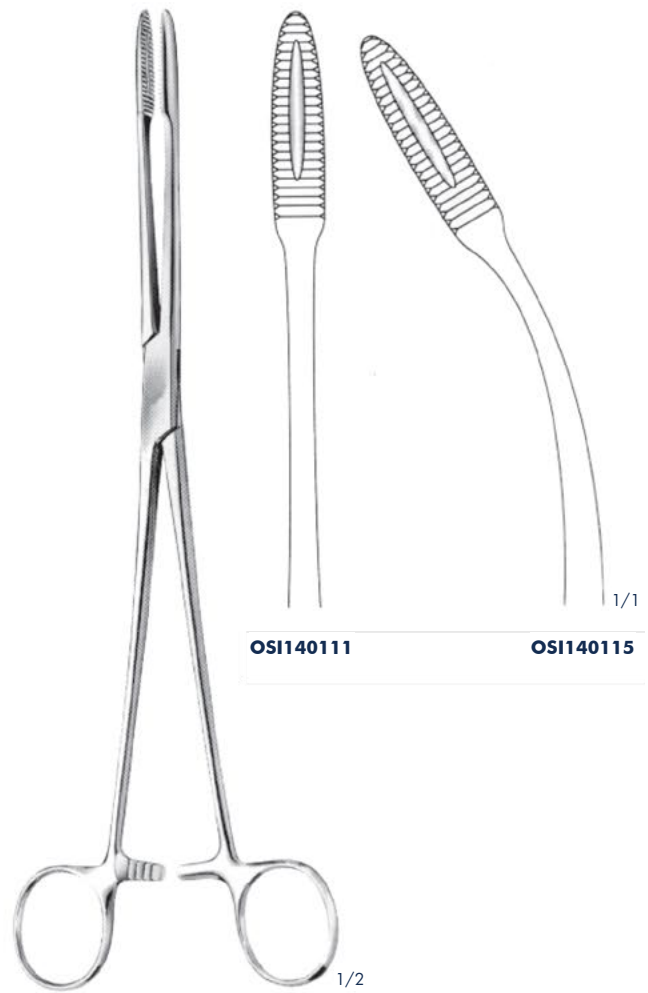

MAIER
OSI140111 - OSI140115
with ratchet
265 mm

Sponge - and Dressing Forceps

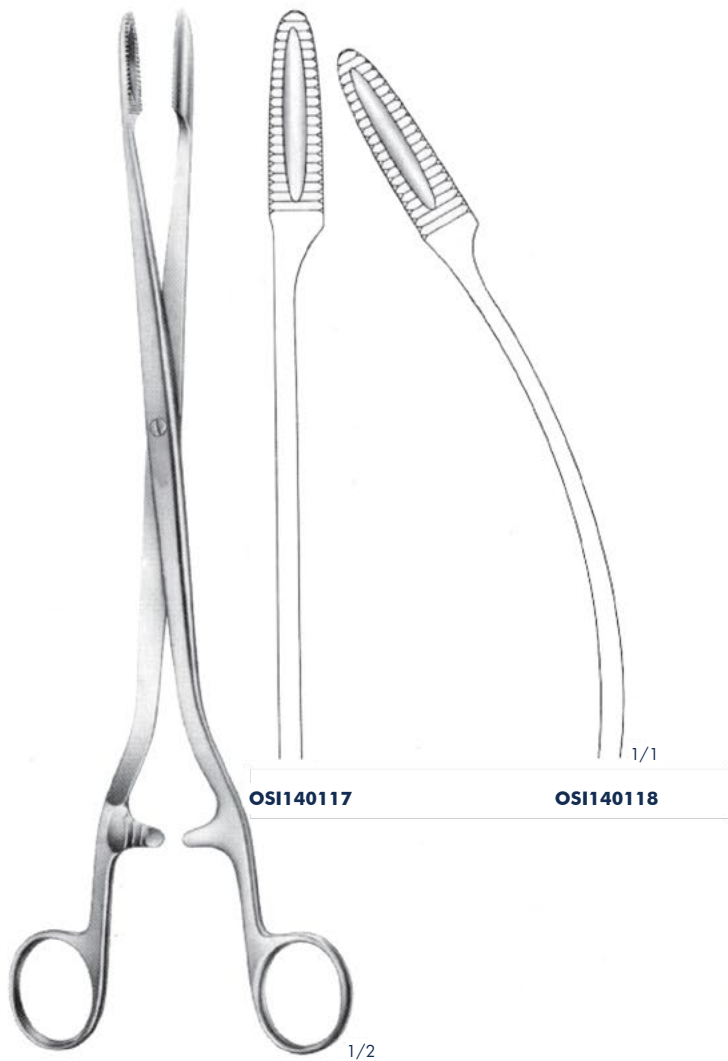

SIMS-MAIER

OSI140117 - OSI140118

280 mm

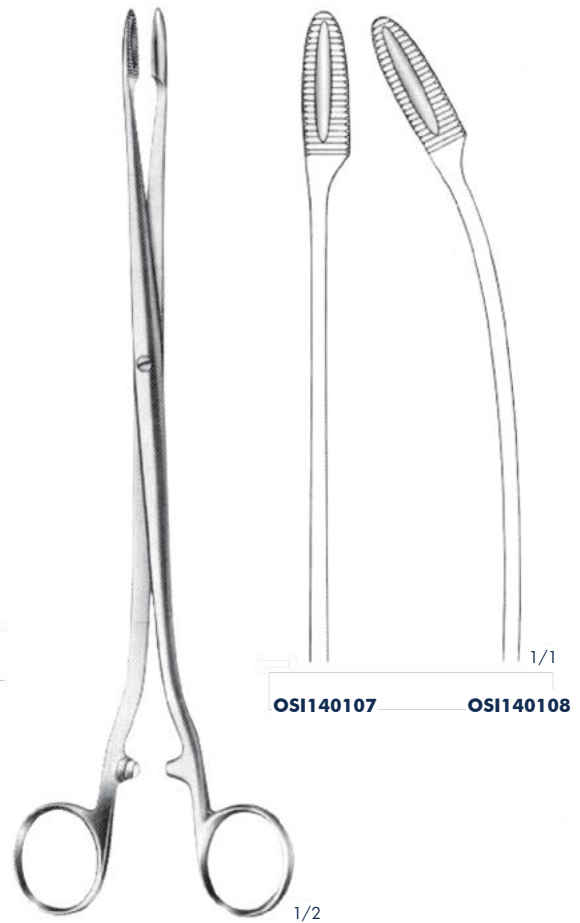

OSI140107 - OSI140108

240 mm

Sponge - and Dressing Forceps



COLLIN
OSI140119
240 mm



CHERON
OSI140146
Handles angled to side
240 mm



EMMET
OSI140147
210 mm

Dressing - Sponge Holding - Organ - and Tissue Grasping Forceps



OSI140122 — OSI140126

1/2

FOERSTER-BALLENGER
OSI140122 - OSI140126
180 mm

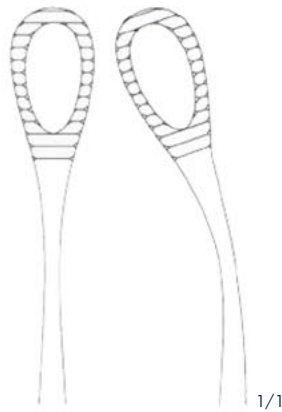

1/1



OSI140148
180 mm

RAMPLEY
OSI140148 - OSI140149

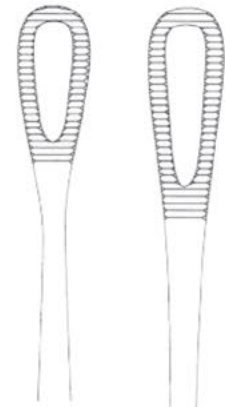

OSI140149
250 mm

1/1



OSI140121
smooth jaws

OSI140125
smooth jaws

OSI140124

OSI140128

1/2

FOERSTER-BALLENGER
OSI140121 - OSI140128
240 mm

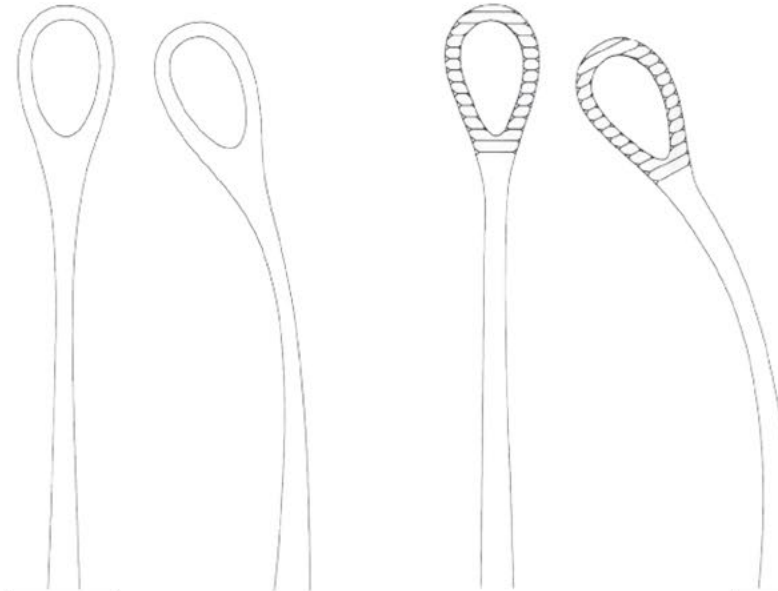

1/1

Organ - and Tissue Grasping Forceps

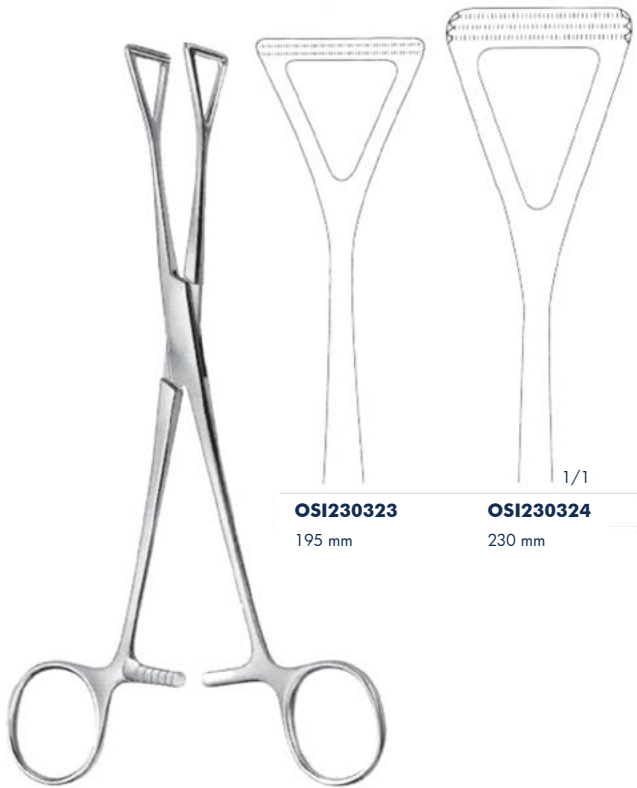

COLLIN
OSI230323 - OSI230324

OSI230323
195 mm

OSI230324
230 mm

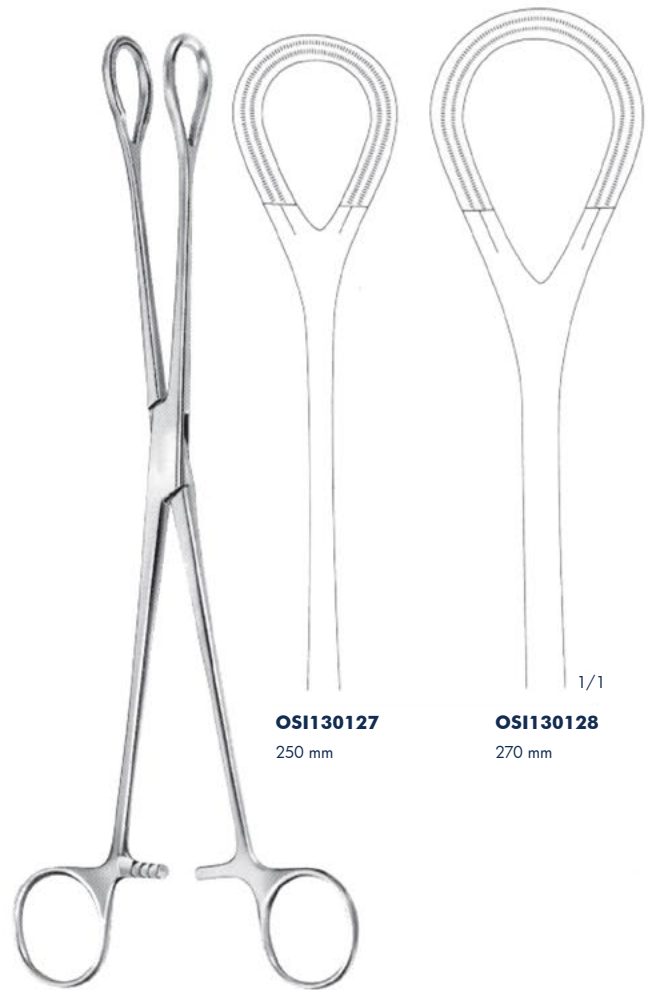

OSI130127 - OSI130128

OSI130127
250 mm

OSI130128
270 mm

Dressing - Sponge Holding - Organ - and Tissue Grasping Forceps



COLLIN
OSI130448 - OSI130130



OSI130448
160 mm



OSI130568
160 mm



OSI130130
170 mm



HEYWOOD-SMITH
OSI230232
200 mm



1/1



HEYWOOD-SMITH modif.
OSI230233
215 mm



1/1

Dressing - Sponge Holding - Organ - and Tissue Grasping Forceps



HEYWOOD-SMITH

OSI240623

250 mm



NOTO

OSI240265

280 mm

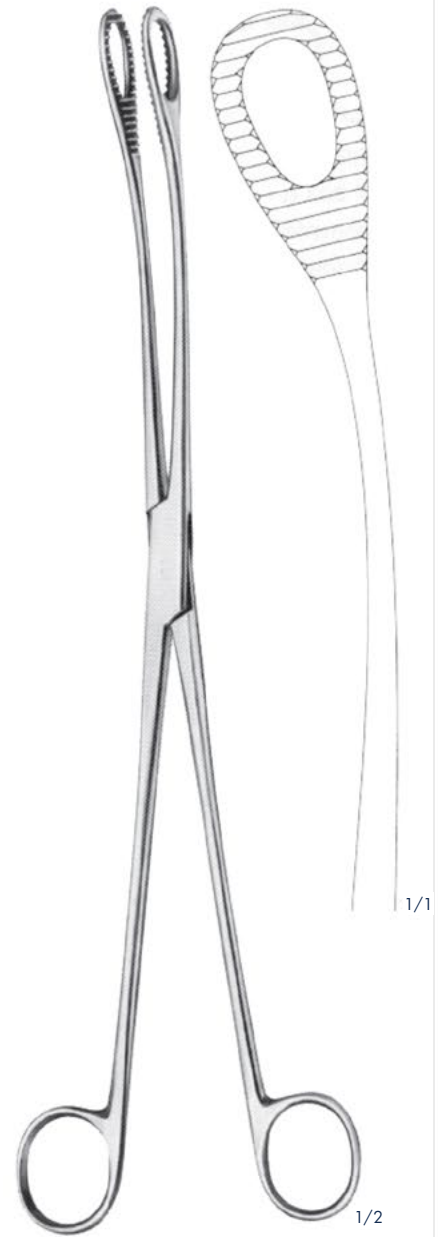

KELLY

OSI240264

320 mm

Tendon Seizing Forceps



HERZ
OSI140150 - OSI140151
 Tendon seizing forceps
 155 mm



JACKSON
OSI140152
 Tendon seizing forceps
 4 x 5 teeth
 150 mm

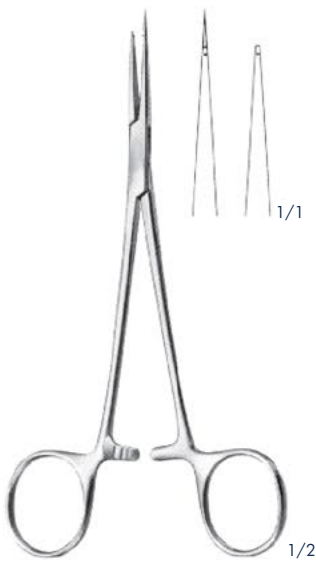

OSI140186
 Tendon interlacing forceps
 150 mm



OSI140187
 Tendon interlacing forceps
 150 mm



OSI140153
 Tendon seizing forceps
 120 mm

Tendon Seizing Forceps



JAGER
OSI140154

Tendon- and cross ligament
passing forceps
flexible shaft, 275 mm

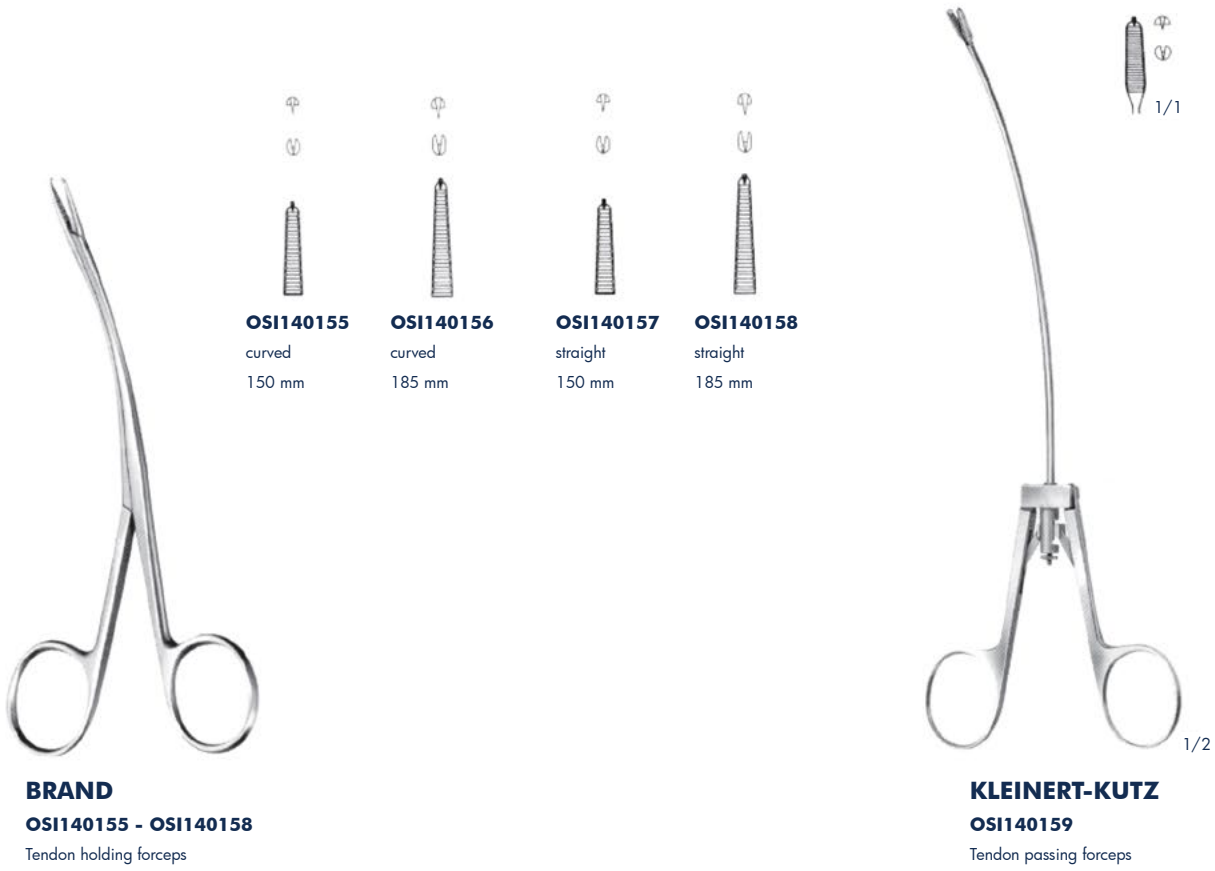

BRAND
OSI140155 - OSI140158
Tendon holding forceps

KLEINERT-KUTZ
OSI140159
Tendon passing forceps
205 mm

Artery Traction - and Tissue Grasping Forceps



POIRIER
OSI140160
 2 x 3 teeth
 125 mm



CHAPUT
OSI140161
 2 x 3 teeth, sharp
 125 mm



TUFFIER
OSI140162
 2 x 3 teeth, sharp
 125 mm



BABY-ALLIS
OSI230101
 4 x 5 teeth
 130 mm



BOYS-ALLIS
OSI230111
 5 x 6 teeth, sharp
 155 mm

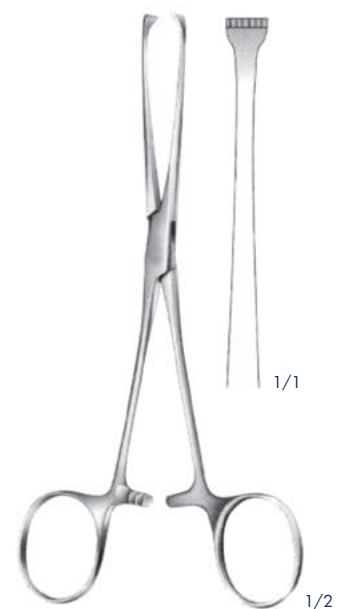

ALLIS
OSI230103
 5 x 6 teeth, blunt
 155 mm

Organ - and Tissue Grasping Forceps



LAHEY
OSI140163
155 mm



LAHEY
OSI220134
155 mm



BRAUN
OSI240262
155 mm



MUSEUX
OSI240612
200 mm



CZERNY
OSI240263
200 mm

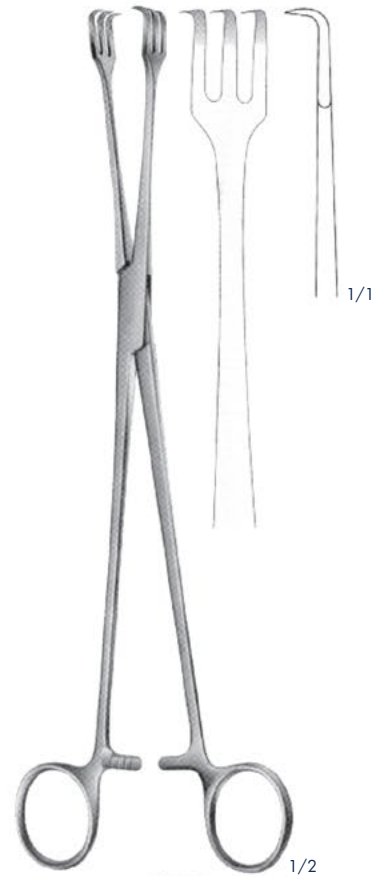

SCHRÖDER
OSI240614
270 mm

Organ - and Tissue Grasping Forceps



OS1240261
260 mm



PRATT
OS1240615
270 mm

Organ - and Tissue Grasping Forceps



TIEMANN

OSI140164

Bullet forceps

220 mm



SCHRÖDER

OSI240245

250 mm

Organ - and Tissue Grasping Forceps



WILSON
OSI240610
240 mm



YOUGN
OSI230431
205 mm

Foreign Body Forceps



OSI230531
210 mm



PITHA
OSI230338
220 mm



PELKMANN
OSI240600 - OSI240601
260 mm

Towel Clamps



OSI130351
55 mm



JONES
OSI130352
85 mm



ENGL. MOD.
OSI140165
85 mm



SCHAEDEL
OSI140166 - OSI140167
85 mm

Towel Clamps



DOYEN
OSI140168
110 mm

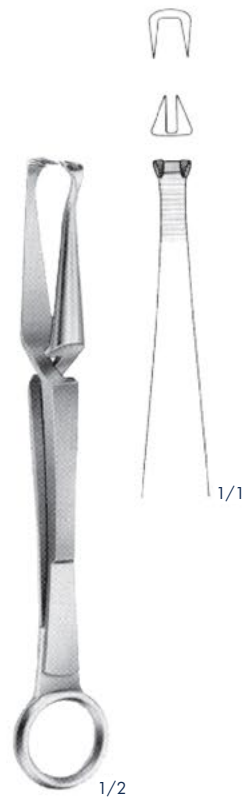

DOYEN
OSI140169
180 mm



MOYNIHAN
OSI140170
190 mm



LANE
OSI130354 - OSI140172

OSI130354
130 mm

OSI140171
155 mm

OSI140172
195 mm

Towel Clamps

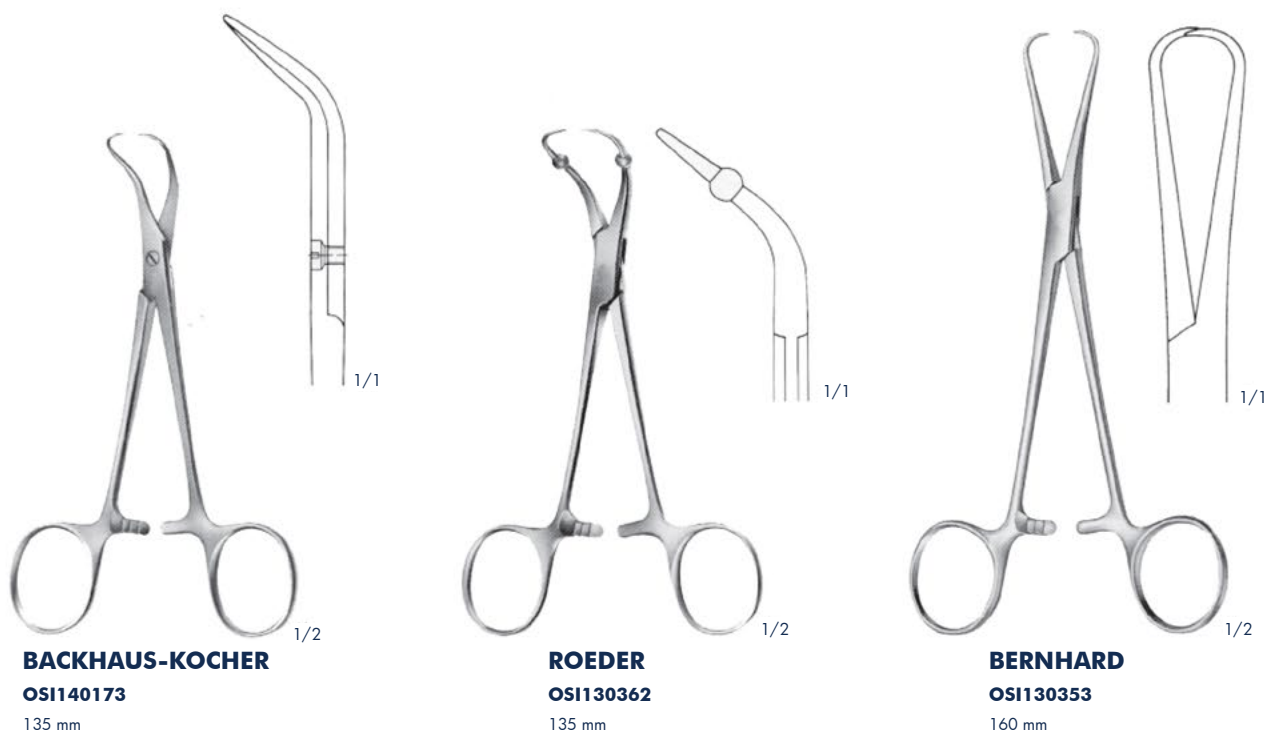
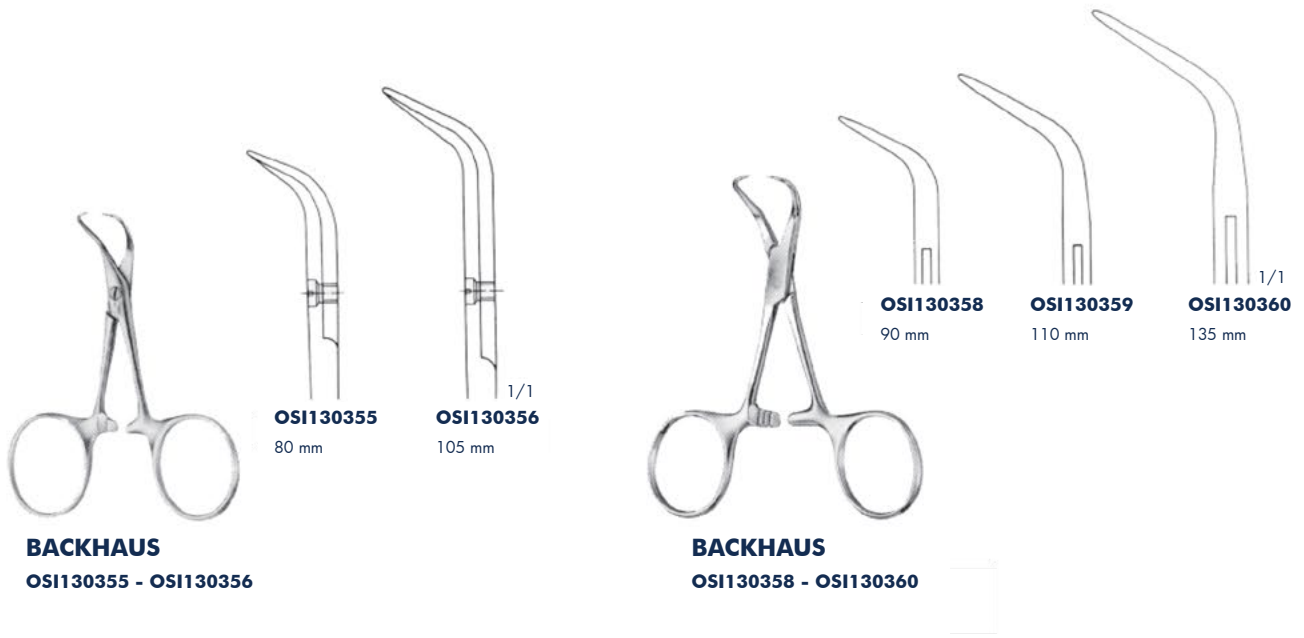

Towel Clamps



ROBIN
OSI140174
 with holders for cable up to 5 mm
 135 mm



ROBIN
OSI140175
 with holders for tubing up to 13 mm
 135 mm

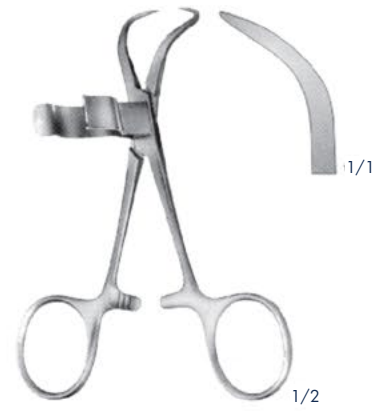

OSI130357
 with holders for tubing up to 15 mm
 110 mm



OSI140176
 Tube fixation forceps with
 atraumatic jaw parts
 140 mm



Especially suitable for HLM
 tubes for cardiovascular surgery

Towel Clamps



OSI140177
non-perforating
95 mm



LORNA
OSI140178
non-perforating
130 mm

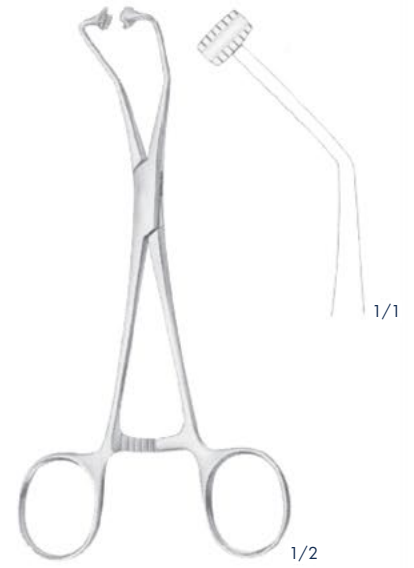

OSI140179
for paper cloths
150 mm



OSI140180
for paper cloths
140 mm



OSI140181
for paper cloths
115 mm

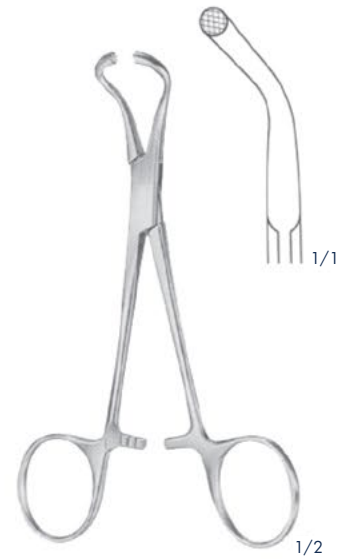

OSI140182
for paper cloths
135 mm

Safety Pins for holding Ring Handle Instruments



BUNT
OS1140183
105 mm



MAYO
OS1140184
140 mm

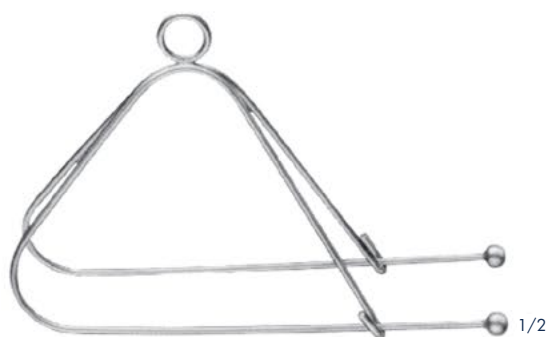

MAYO
OS1140185
double
125 mm





BIEMER Vessel Clips

MEHDORN Vessel Clips Mini size

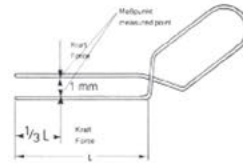
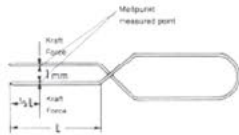



for temporary occlusion

- Blade gripping surface with oblique serrations for safe but careful gripping of vessels.
- No risk due to rigidly fixed pressure measure guarantees application without any risk.
- Closing force is measured at 1/3 of the blades at 1 mm opening



BIEMER				
	Opening	Length of jaws	Closing Force	Applying Forceps
OSI130371 	4,0 mm	6 mm	30 - 40 g (0,29 - 0,39 N)	OSI130374 or OSI130375
OSI130372 	5,0 mm	9 mm		
OSI130373 	5,0 mm	9 mm		

(identified by yellow coloured spring ends) for vessels
diam. 0,5 - 2,0 mm

MEHDORN			
	Jaws	Closing Force	Applying Forceps
	4 x 1,0 mm	10 - 15 g (0,10 - 0,15 N)	
	4 x 1,4 mm	15 - 20 g (0,15 - 0,20 N)	
	6 x 1,0 mm	10 - 15 g (0,10 - 0,15 N)	
	6 x 1,4 mm	15 - 20 g (0,15 - 0,20 N)	

(identified by yellow coloured spring ends) for vessels
diam. 0,5 - 1,5 mm (extra-intercranial anastomosis.)

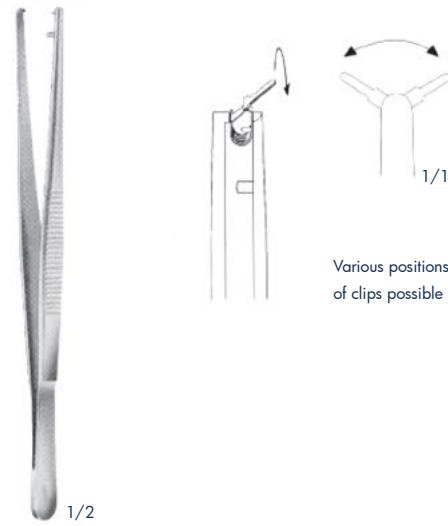

145 mm













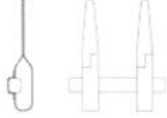



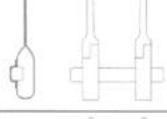

Applying forceps for MEHDORN vessel clips
150 mm

TUBB
OSI180
230 mm
Set, consi
45°
Ø 4,5 mm

BIEMER - MÜLLER, Approximators

for micro vessel anastomosis in the superficial range

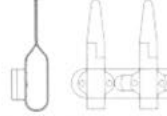
- Blade gripping surface with oblique serrations for careful but safe holding of the vessel ends.
- No risk due to rigidly fixed pressure measure.
- Adjustable distance between the clips and automatic fixation by tilting.
- Even when applied, the lightweight construction allows easy, distortionless turning and makes suturing possible on the other side of the vessel.

Micro approximators						
	OSI130381 		Opening	Length of jaws	Closing Force 25 - 30 g (0,25 - 0,29 N)	Applying Forceps OSI130374 or OSI130375 (siehe S. 214, look on p.2014)
	OSI130382 		5 mm	9 mm		
	OSI130383 		5 mm	9 mm		
	OSI130384 		5 mm	9 mm		
	OSI130385 		3 mm	4,5 mm		
Micro approximators						
	OSI130386 		4 mm	6 mm	30 - 40 g (0,29 - 0,39 N)	OSI130387 



OSI130387
Applying forceps for BIEMER vessel approximator
145 mm

S
285
sting of:
m

Approximators BIEMER Approximators for nerves

for micro vessel anastomosis in the deeper range,
also for experimental surgery

- Blade gripping surface with oblique serrations for careful but safe holding of the vessel ends.
- The pressure measure is adjusted with key
- The distance between the clips is variable and fixed with key

for safe adaption of nerve anastomoses

- Piercing the nerve centre with fine needles prevents strong pathological changes.
- Needles can be exchanged with key
- Distance between the needles is variable and can be fixed with key



1/1

OSI130388

Approximator for complete,
with key



1/1

BIEMER

OSI130389

Approximator for nerves
complete, with key



1 Pair of spare needles

MÜLLER Vessel Clips



Closing force

OS1130390 50 g
OS1130391 80 g
 straight

1/1



Closing force

OS1130392 50 g
OS1130393 80 g
 curved

1/1



OS1130394 50 g
OS1130395 80 g
 curved tips

1/1



OS1130396 50 g
OS1130397 80 g
 angled to side

1/1



OS1130398 50 g
OS1130399 80 g
 knee-bent

1/1

MÜLLER

OS1130390 - OS1130399

Non-traumatic vessel clips, temporary



jaw profiles, finally
 cross-serrated

MÜLLER
OS1130400

1/1

MÜLLER Vascular Clips

MÜLLER Vascular Clips

Features:

- Atraumatic mouth profile
- Handle plateaux mounted on both sides for secure application and removal of the clip.
- Exactly defined closing pressure for arterial and venous vessels.
- Vascular clips are clearly marked with closing pressure.
- Closed mouth box guarantees precise guidance of the working tips.
- No risk of threads getting tangled up in clip.

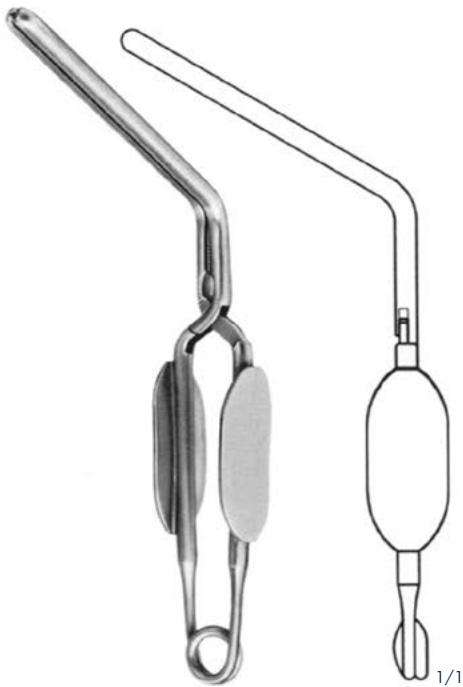

MÜLLER
OSI130401
OSI130402
straight

Closing force
250 g
350 g

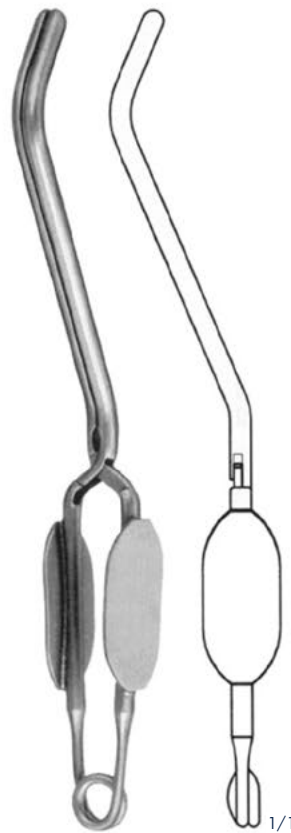

MÜLLER
OSI130403
OSI130404
curved

Closing force
250 g
350 g



MÜLLER
OSI130405
OSI130406
curved tips

Closing force
250 g
350 g

MÜLLER Vascular Clips

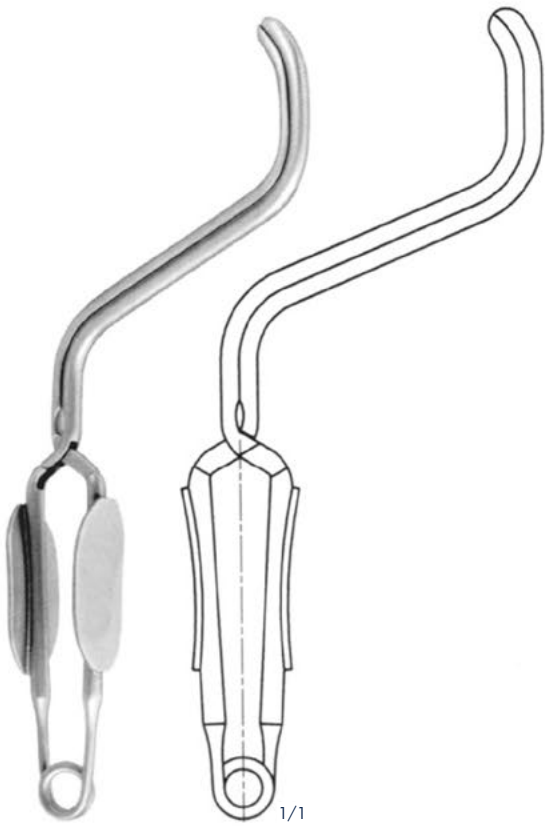

MÜLLER
OS1130407
OS1130408
angled-shaped

Closing force
250 g
350 g



MÜLLER
OS1130409
OS1130410
knee-bent

Closing force
250 g
350 g

Bulldog Clamps



1/1

OSI130411
35 mm



1/1

OSI130412
35 mm



1/1

OSI130413
45 mm



1/1

OSI130414
45 mm



DIEFFENBACH
OSI130415 38 mm
OSI130417 48 mm



DIEFFENBACH
OSI130416 38 mm
OSI130418 48 mm



1/1

DIEFFENBACH
OSI130419 58 mm



1/1

DIEFFENBACH
OSI130420 58 mm



1/2

JOHNS-HOPKINS
OSI130569
240 mm



JOHNS-HOPKINS
OSI130421 38 mm
OSI130109 48 mm
OSI130422 56 mm
OSI130110 63 mm
OSI130423 70 mm
OSI130111 80 mm
OSI130424 91 mm



1/1

DE BAKEY-HESS
OSI130425
Length of jaw:
20 mm





















1/1

DE BAKEY-HESS
OSI130426
Length of jaw:
30 mm

Bulldog Clamps

ATRAUMATIC

					
1/2	1/2	1/2	1/2	1/2	1/2
DE BAKEY OSI130427	DE BAKEY OSI130428	GLOVER OSI130429	DE BAKEY OSI200108	DE BAKEY OSI200110	DE BAKEY OSI200109
Total length 50 mm	48 mm	57 mm	73 mm	99 mm	95 mm
Length of jaws 27 mm	27 mm	35 mm	38 mm	63 mm	54 mm
					
DE BAKEY OSI130430	DE BAKEY OSI130432	DE BAKEY OSI130434	DE BAKEY OSI130436	DE BAKEY OSI130431	DE BAKEY OSI130433
Total length 80 mm	90 mm	105 mm	124 mm	78 mm	86 mm
Length of jaw 25 mm	35 mm	50 mm	68 mm	25 mm	35 mm
					
GLOVER OSI130438	GLOVER OSI130440	GLOVER OSI130442	GLOVER OSI130439	GLOVER OSI130441	GLOVER OSI130443
Total length 68 mm	96 mm	117 mm	65 mm	91 mm	110 mm
Length of jaw 33 mm	50 mm	69 mm	33 mm	50 mm	69 mm

Delicate Hemostatic Forceps



CARREL
OSI130112
85 mm



**BABY-MOSQUITO
(HARTMANN)**
OSI130136 - OSI130156
100 mm

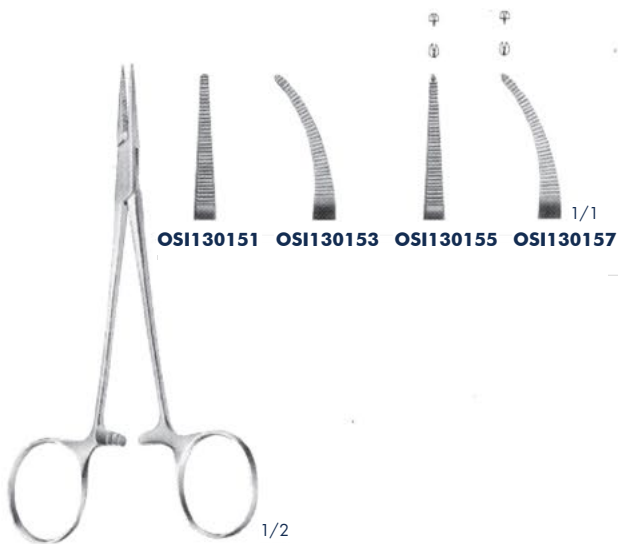

MICRO-HALSTED
OSI130151 - OSI130157
125 mm

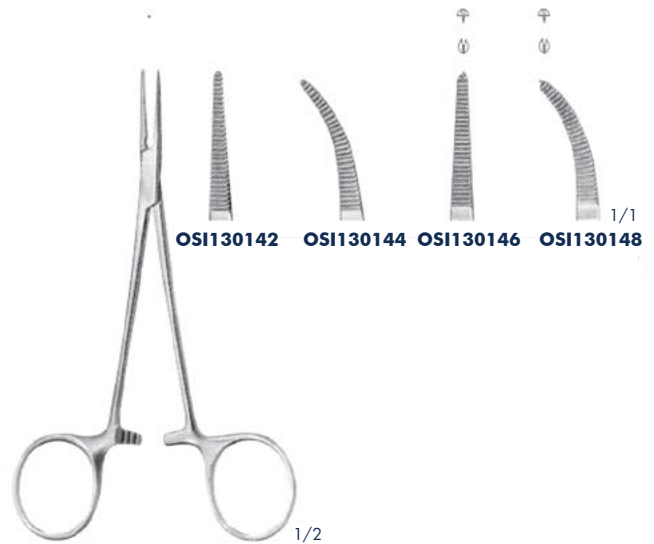

HALSTED-MOSQUITO
OSI130142 - OSI130148
125 mm

Delicate Hemostatic Forceps



OSI130175 OSI130176 1/1

1/2

PROVIDENCE-HOSPITAL
OSI130175 - OSI130176
140 mm



OSI130170 OSI130171 1/1

1/2

KELLY
OSI130170 - OSI130171
140 mm



OSI130186 OSI130187 1/1

1/2

DANDY
OSI130186 - OSI130187
curved to side
140 mm



OSI130444 OSI130445 OSI130446 OSI130447 1/1

1/2

(PEAN)

BABY-CRILE
OSI130444 - OSI130447
140 mm



(KOCHER)



OSI130177 OSI130178 OSI130179 OSI130180 1/1

1/2

CRILE
OSI130177 - OSI130180
140 mm



Delicate Hemostatic Forceps



DUNHILL
OSI130454
125 mm



CAIRNS
OSI130477 - OSI130455
150 mm



MOYNIHAN
OSI130456
curved to side
145 mm



MOYNIHAN
OSI130457
150 mm

Delicate Hemostatic Forceps



OSI130166 OSI130167 OSI130168 OSI130169 1/1

LERICHE
OSI130166 - OSI130169
150 mm



OSI130172 OSI130173 1/1

RANKIN
OSI130172 - OSI130173
160 mm

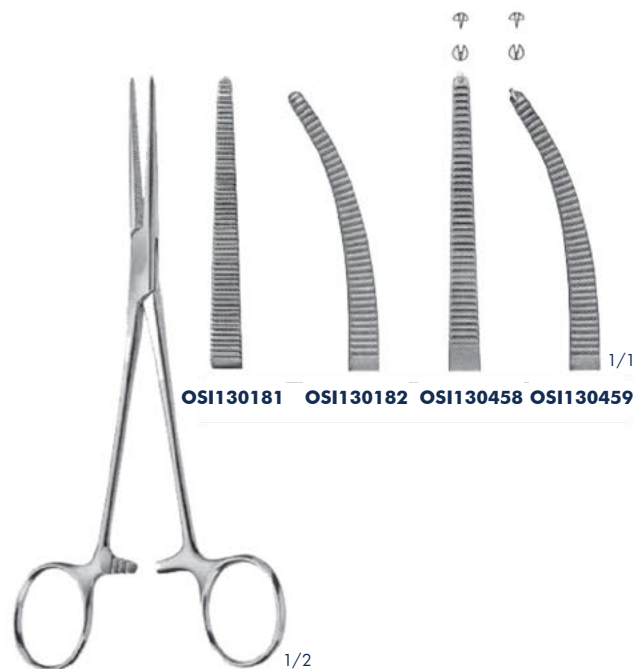

OSI130181 OSI130182 OSI130458 OSI130459 1/1

CRILE
OSI130181 - OSI130459
160 mm



OSI130460 OSI130461 1/1

DIXON-LOVELACE
OSI130460 - OSI130461
160 mm

Delicate Hemostatic Forceps



FUCHSIG
OSI130462
190 mm

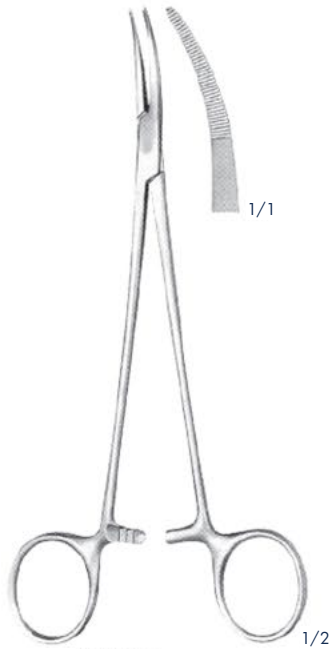

NISSEN
OSI130463
185 mm



ADSON
OSI130194 - OSI130195
185 mm



HALSTED
OSI130158 - OSI130161
185 mm



HALSTED-MOSQUITO
OSI130162 - OSI130165
200 mm

Delicate Heamostatic Forceps

1/1

1/2

FRASER-KELLY (CRILE)

OSI130464

180 mm

1/1

1/1

1/2

1/2

DUNHILL

OSI130465

190 mm

GREY-TURNER

OSI130466

180 mm

Delicate Hemostatic Forceps

OSI130256 **OSI130257** **OSI130258** **OSI130467** **OSI130468**^{1/1}
200 mm 200 mm 195 mm 200 mm 200 mm

HEISS
OSI130256 - OSI130468

OSI130469 **OSI130470**^{1/1}

BIRKETT
OSI130469 - OSI130470
185 mm

1/2

^{1/1}
OSI130471 **OSI130472**

OSI130212 **OSI130213** **OSI130214** **OSI130215**

HALSTED
OSI130471 - OSI130472
1/2 215 mm

BENGOLEA
OSI130212 - OSI130215
1/2 245 mm

Delicate Hemostatic Forceps

1/1

OSI130260 OSI130473

1/1

1/2

SAROT
OSI130260 - OSI130473
240 mm

1/2

CRAFOORD
OSI130261
245 mm

Delicate Hemostatic Forceps

1/1

OSI130475 OSI130476

1/1

1/2

CRAFOORD, MOD.
OSI130474
240 mm

1/2

BRIDGE
OSI130475 - OSI130476
275 mm

Haemostatic Forceps

PEAN
OSI130449
125 mm

1/2

1/1

KRÖNLEIN
OSI130116
130 mm

1/1

1/2

FRICKE
OSI120356
Artery forceps
130 mm

1/2

1/1

OSI130479 OSI130114
125 mm 140 mm

1/1

1/1

OSI130481 OSI130482
165 mm 185 mm

1/1

PEAN
OSI130479 - OSI130114

1/2

PEAN
OSI130480
125 mm

PEAN
OSI130481 - OSI130482

1/2

Heamostatic Forceps

OSI130196 **OSI130197** **OSI130199** **OSI130200** 1/1
130 mm 140 mm 130 mm 140 mm

OSI130483 **OSI130484** **OSI130485** 1/1
130 mm 140 mm 140 mm

PEAN
OSI130196 - OSI130200
slender type

PEAN
OSI130483 - OSI130485

OSI130117 **OSI130119** **OSI130120** **OSI130121** **OSI130122** **OSI130124** **OSI130125** **OSI130126** **OSI130486** 1/1
130 mm 150 mm 175 mm 200 mm 130 mm 150 mm 175 mm 200 mm 230 mm

SPENCER-WELLS
OSI130117 - OSI130486

Heamostatic Forceps

1/1

OSI130217	OSI130218	OSI130219	OSI130220	OSI130221
160 mm	185 mm	200 mm	225 mm	240 mm

1/1

OSI130225	OSI130226	OSI130227	OSI130228	OSI130487
160 mm	185 mm	200 mm	225 mm	240 mm

ROCHESTER-PEAN
OSI130217 - OSI130487

Heamostatic Forceps

1/1

OSI130488 **OSI130222** **OSI130223**
240 mm 260 mm 280 mm

OSI130229 **OSI130230** **OSI130231**
240 mm 260 mm 280 mm

PEAN
OSI130488 - OSI130231

Heamostatic Forceps

1/1

OSI130202
130 mm

OSI130203
140 mm

1/1
OSI130206
140 mm

1/2

KOCHER
OSI130489
strong pattern
145 mm

1/2

KOCHER
OSI130202 - OSI130206

1/1

OSI130147 **OSI130149**

1/1

OSI130204 **OSI130207**

1/2

ROCHESTER-OCHSNER
OSI130147 - OSI130149
140 mm

1/2

KOCHER
OSI130204 - OSI130207
150 mm

Heamostatic Forceps

1/1

160 mm 185 mm 200 mm 225 mm 240 mm 260 mm 280 mm

1/1

KOCHER-OCHSNER
OSI130233 - OSI130491

160 mm 185 mm 200 mm 225 mm 240 mm 260 mm 280 mm

Haemostatic Forceps, special patterns

1/1

1 x 2 teeth

1/1

160 mm 200 mm 160 mm 200 mm

ROCHESTER-CARMALT
OSI130188 - OSI130191

FICKLING
OSI130492 - OSI130493
180 mm

1/2

1/1

1/1

ROBERTS
OSI130494
225 mm

1/2

ROBERTS
OSI130495 - OSI130496
250 mm

Heamostatic Forceps, special patterns

1/1

230 mm

240 mm

1/1

195 mm

220 mm

230 mm

MOYNIHAN

OSI130343 - OSI130344

PEAN

OSI130312 - OSI130314

Haemostatic Forceps, Tonsil Forceps

OSI260130 1/1
OSI260131

OSI260132 1/1
OSI260133

1/2
SCHNIDT
OSI260130 - OSI260131
185 mm

1/2
SCHNIDT
OSI260132 - OSI260133
185 mm

1/1
OSI130330 OSI130331

1/1

1/1

1/2
NEGUS
OSI130330 - OSI130331
190 mm

1/2
WILSON
OSI130497
190 mm

1/2
MIKULICZ
OSI130498
185 mm

Haemostatic Forceps, special patterns

1/1

1/1

1/2

1/2

PENNINGTON
OSI130131
155 mm

COLLIN
OSI130448
160 mm

1/1

1/1

1/2

1/2

COLLIN
OSI130130
170 mm

COLLIN
OSI130568
160 mm

Dissecting - and Ligature Forceps

OSI130499

Ligature forceps straight,
smooth jaws
95 mm

1/2

MICRO-ADSON
OSI130133
140 mm

1/2

BABY-OVERHOLT
OSI130174
135 mm

1/2

OSI130134 **OSI130253**
140 mm 180 mm

1/1

OSI130254 **OSI130255**
140 mm 180 mm

1/1

BABY-MIXTER
OSI130134 - OSI130253

BABY-ADSON
OSI130254 - OSI130255

NISSEN
OSI130463
185 mm

1/2

1/1

1/1

1/1

1/1

Dissecting - and Ligature Forceps

1/1

1/1

185 mm 210 mm 215 mm 220 mm

OSI130248 - OSI130251

S-shaped, delicate

1/2

OVERHOLT-MIXTER

OSI130259

205 mm

Dissecting - and Ligature Forceps

Fig.0	1	2	3	4	5	6	1/1
195 mm	210 mm	220 mm	225 mm	210 mm	230 mm	225 mm	
	260 mm	270 mm	275 mm	270 mm	280 mm		

OVERHOLT-GEISSENDOERFER OSI130264 - OSI130276

Fig.0	1	2	3	6	1	4	0	1	6	1/1
215 mm	210 mm	220 mm	225 mm	225 mm	260 mm	270 mm	295 mm	295 mm	300 mm	

OVERHOLT OSI130500 - OSI130509 fine pattern

Dissecting - and Ligature Forceps

1/1

130 mm 160 mm 180 mm 200 mm 230 mm 250 mm 280 mm

GEMINI
OSI130282 - OSI130281

Dissecting - and Ligature Forceps

MIXTER-O'SHAUGNESSY
OSI130304
190 mm

1/2

1/1

O'SHAUGNESSY
OSI130511
220 mm

1/2

1/1

HEISS
OSI130258
195 mm

1/2

1/1

1/1

OSI130293

1/1

WIKSTROEM
OSI130303
205 mm

1/2

RUMEL
OSI130289 - OSI130293
240 mm

1/2

Dissecting - and Ligature Forceps

1/1

1/1

1/2

1/2

RUMEL
OSI130512
non-traumatic
250 mm

FINOCHIETTO
OSI130513
245 mm

Dissecting - and Ligature Forceps

1/1

KANTROWITZ

OSI130514 190 mm

OSI130515 240 mm

OSI130516 265 mm

1/1

OSI130517

150 mm

OSI130518

180 mm

OSI130519

200 mm

OSI130520

230 mm

OSI130521

255 mm

O'SHAUGHNESSY

OSI130517 - OSI130521

Dissecting - and Ligature Forceps

1/1

1/1

1/2

MIXTER
OSI130306
230 mm

1/2

LAWRENCE
OSI130522
270 mm

Dissecting - and Ligature Forceps

1/1

OSI130262
300 mm

OSI130263
290 mm

1/1

ZENKER
OSI130262 - OSI130263

1/2

KIEBACK
OSI130523
Ureteral tunnel clamp
curved to side
235 mm

Dissecting - and Ligature Forceps

1/1
180 mm

1/1
OSI230512 OSI130524 OSI130525
200 mm 225 mm 230 mm

1/1
OSI130308 OSI130309
220 mm 250 mm

LOWER
OSI230511

LAHEY (SWEET)

MIXTER
OSI130308 - OSI130309

1/1

1/1

1/1
OSI130318 OSI130319

DESJARDINS
OSI130320
220 mm

NISSEN
OSI230513
215 mm

1/2

GRAY
OSI130318 - OSI130319
220 mm

Peritoneum Forceps

1/1

1/1

1/1

MIKULICZ
OSI130531
245 mm

MIKULICZ
OSI130532
205 mm

1/2

MIKULICZ
OSI130533
205 mm

1/2

1/1

1/1

OSI130349 OSI130350

1/1

1/2

MIKULICZ
OSI130534
185 mm

1/2

SCHINDLER
OSI130535
200 mm

1/2

FAURE
OSI130349 - OSI130350
205 mm

Peritoneum Forceps

OSI130333
210 mm

1/1
OSI130334
205 mm

OSI130537
205 mm

1/1
OSI130538
250 mm

PHANEUF
OSI130333 - OSI130334

MAINGOT
OSI130537 - OSI130538

1/1

1/1
OSI130339 **OSI130340**
205 mm 245 mm

1/2
MAINGOT
OSI130536
200 mm

HEANEY MODIF.
OSI130339 - OSI130340

Hysterectomy Forceps

1/1
195 mm

OSI130539 OSI130542
220 mm 240 mm

1/1

HEANEY
OSI130335

1/2

WIENER MODELL
OSI130539 - OSI130542

Hysterectomy - and Hysterectomy Forceps

1/1

WERTHEIM
OSI130543
235 mm

1/1

WERTHEIM
OSI130542
235 mm

1/1

WERTHEIM
OSI130544
245 mm

1/2

1/2

1/2

1/1

SEGOND-LANDAU
OSI130540
240 mm

1/1

SEGOND
OSI130541
240 mm

1/1

OSI130545 **OSI130546**

HOLZBACH
OSI130545 - OSI130546
245 mm

1/2

1/2

1/2

Hysterectomy - and Heamostatic Forceps

1/1

OSI130547

1/1

OSI130548

GWILLIAM

OSI130547 - OSI130548

1 x 2 teeth

200 mm

1/2

BERKELEY - BONNEY

OSI130549

200 mm

A TRAUMATIC

OSI130550
225 mm

OSI130551
220 mm

1/1
OSI130552
215 mm

HEANEY
OSI13050 - OSI13052

OSI130553
250 mm

OSI130554
245 mm

OSI130555
240 mm

1/1
OSI130556
220 mm

WERTHEIM
OSI130553 - OSI130556
Parametrium clamps

Hysterectomy Forceps and Vaginal Clamps

1/1

1/1

1/2

WERTHEIM

OSI130557

Hysterectomy forceps
255 mm

1/2

WERTHEIM

OSI130346

Parametrium clamp
260 mm

Hysterectomy Forceps and Vaginal Clamps

1/1

1/1

1/2

BURKE

OSI130558

Parametrium clamp,
short jaw part
250 mm

1/2

BURKE

OSI130559

Parametrium clamp,
long jaw part
250 mm

Clamps and Compression Forceps

A TRAUMATIC

90°

1/1

67 mm

1/1

OSI230455 **OSI230456** **OSI230457**
255 mm 265 mm 275 mm

1/2

DICK
OSI230455 - OSI230457

WERTHEIM
OSI130560
250 mm

Clamps and Compression Forceps

1/1

1/1

1/1

OSI200517
60 mm

OSI200518
80 mm

1/2

WERTHEIM-CULLEN
OSI130341
215 mm

1/2

OSI200517 - OSI200518
230 mm

Surgical Needles

	000		
	00		1
	0		2
	1		3
	2		4
	3		5
	4		6
	5		7
	6		8
	7		9
	8		10
	9		11
	10		12
	11		13
	12		14
	13		15
	14		16
* B	15	* G	16

Fig.

000	OSI170431	OSI170450		
00	OSI170432	OSI170451		
0	OSI170433	OSI170452		
1	OSI170434	OSI170453	OSI170469	OSI170485
2	OSI170435	OSI170454	OSI170470	OSI170486
3	OSI170436	OSI170455	OSI170471	OSI170487
4	OSI170437	OSI170456	OSI170472	OSI170488
5	OSI170438	OSI170457	OSI170473	OSI170489
6	OSI170439	OSI170458	OSI170474	OSI170490
7	OSI170440	OSI170459	OSI170475	OSI170491
8	OSI170441	OSI170460	OSI170476	OSI170492
9	OSI170442	OSI170461	OSI170477	OSI170493
10	OSI170443	OSI170462	OSI170478	OSI170494
11	OSI170444	OSI170463	OSI170479	OSI170495
12	OSI170445	OSI170464	OSI170480	OSI170496
13	OSI170446	OSI170465	OSI170481	OSI170497
14	OSI170447	OSI170466	OSI170482	OSI170498
15	OSI170448	OSI170467	OSI170483	OSI170499
16	OSI170449	OSI170468	OSI170484	OSI170500

Surgical Needles

* Suture needles are supplied in packages of 12 pieces =

	1		000
	2		00
	3		0
	4		1
	5		2
	6		3
	7		4
* Ga		* E	5

Fig.			
000			OSI170515
00			OSI170516
0			OSI170517
1	OSI170501	OSI170508	OSI170518
2	OSI170502	OSI170509	OSI170519
3	OSI170503	OSI170510	OSI170520
4	OSI170504	OSI170511	OSI170521
5	OSI170505	OSI170512	OSI170522
6	OSI170506	OSI170513	
7	OSI170507	OSI170514	

Fig.		* Keith
1	OSI170523	1
2	OSI170524	2
3	OSI170525	3
4	OSI170526	4
5	OSI170527	5
6	OSI170528	6

Surgical Needles and Suture Material

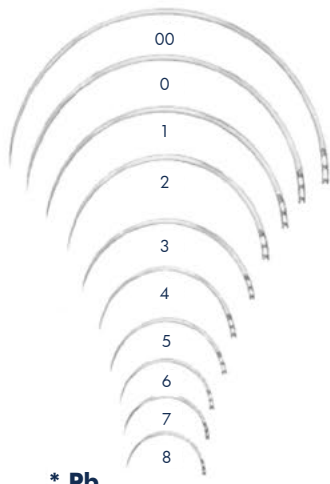

* **Pb**

Intestinal needles

Fig.	
00	OSI170529
0	OSI170530
1	OSI170531
2	OSI170532
3	OSI170533
4	OSI170534
5	OSI170535
6	OSI170536
7	OSI170537
8	OSI170538

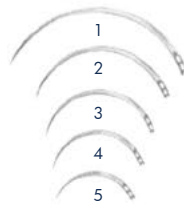

* **Ob**

Eye needles

OSI170539
OSI170540
OSI170541
OSI170542
OSI170543

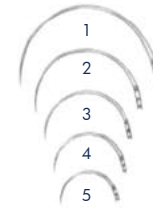

* **Og**

Eye needles

OSI170544
OSI170545
OSI170546
OSI170547
OSI170548

* Suture needles are supplied in packages of 12 pieces = DZ.

Needle Cases

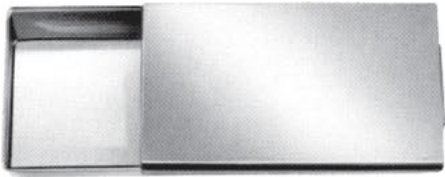

OSI170295 70 x 53 x 9 mm



OSI170296 150 x 90 x 10 mm

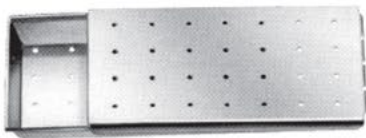

OSI170297 50 x 25 x 5 mm
OSI170298 50 x 30 x 6 mm
OSI170299 75 x 25 x 5 mm



OSI170300
 205 x 120 x 12 mm



OSI170301 65 x 16 mm
OSI170302 95 x 16 mm
OSI170303 65 x 16 mm
 exterior box of only



Interior box only

OSI170304
OSI170305



OSI170306
 220 x 190 x 8 mm

Needle Holders for Micro Surgery



CASTROVIEJO
OSI170121 - OSI170122
 with catch
 145 mm



OSI170264 - OSI170265
 without catch
 160 mm



OSI170266 - OSI170267
 without catch
 185 mm

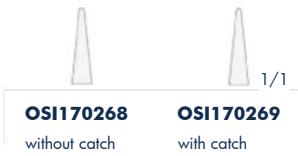

JACOBSON
OSI170268 - OSI170269
 185 mm

Needle Holders for Micro Surgery



OSI170270
without catch
195 mm



YASARGIL
OSI170271
with catch
200 mm

Micro Needle Holders with round handles



... with round handles

Round handles allow turning manipulations between the fingers.

Optimum balance individually for each instrument due to solid or hollowed-out handles.



OSI170119
115 mm



OSI170272
135 mm



1/1

BARRAQUER
OSI170119 - OSI170272
without catch



1/2

OSI170273 **OSI170274**



1/1

BARRAQUER
OSI170273 - OSI170274
without catch
120 mm



1/2

OSI170275 **OSI170276**



1/1

BARRAQUER
OSI170275 - OSI170276
with catch
120 mm

Micro Needle Holders with round handles



REILL
OS1170277 - OS1170278
without catch
150 mm



OS1170279 - OS1170280
with catch
150 mm



OS1170281 - OS1170282
without catch
185 mm



OS1170283 - OS1170284
with catch
185 mm

Micro Needle Holders

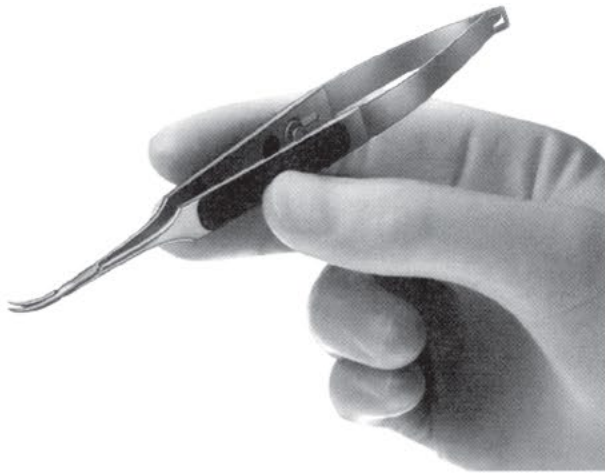

micro instruments with
light plastic handle



MÜLLER
OSI170285
Handle colour: green
145 mm

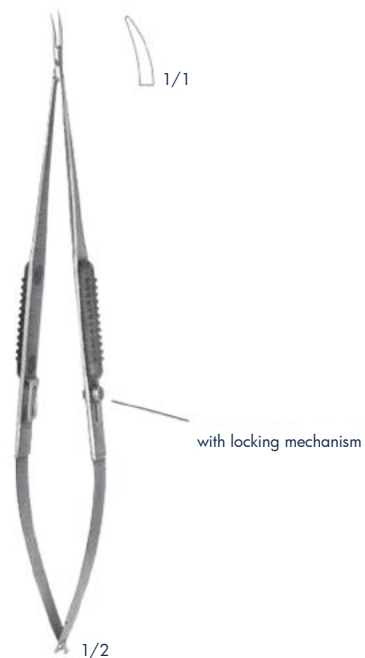

MÜLLER
OSI170286
Handle colour: green
180 mm

Micro Needle Holders, bayonet - shaped



... with YASARGIL Profil Handles



YASARGIL
OSI170287 - OSI170288
200 mm



YASARGIL
OSI170289 - OSI170290
225 mm

Needle Holders



CONVERSE
OSI170291
125 mm



WEBSTER
OSI170131
125 mm



HALSEY
OSI170132 - OSI170292
130 mm



DERF
OSI170293
125 mm



DOYEN
OSI170294
125 mm



BAUMGARTNER
OSI170133
145 mm

Needle Holders



Needle Holders



LAWRANCE
OSI170310
150 mm



SENNING
OSI170311
170 mm

Designed for frontal and palate suture.



ADSON
OSI170143
175 mm

Needle Holders



OSI170135 150 mm
OSI170136 180 mm
OSI170137 200 mm 1/1

MAYO-HEGAR
OSI170135 - OSI170137
 medium fine patterns



OSI170312 150 mm
OSI170313 175 mm
OSI170314 205 mm
OSI170315 205 mm 1/1

HEGAR
OSI170312 - OSI170315
 heavy patterns



OSI170316 165 mm
OSI170317 190 mm 1/1

MAYO-HEGAR
OSI170316 - OSI170317

Needle Holders



HEANEY (HEGAR)

OSI170152

200 mm



JAMESON

OSI170153

230 mm

Needle Holders



WANGENSTEEN
OSI170161
275 mm



MASSON
OSI170154
265 mm

Needle Holders



NAUNTAN MORGAN
OSI170318
255 mm



MASSON-LUETHY
OSI170319
255 mm

Needle Holders

* Needle holders with scissors

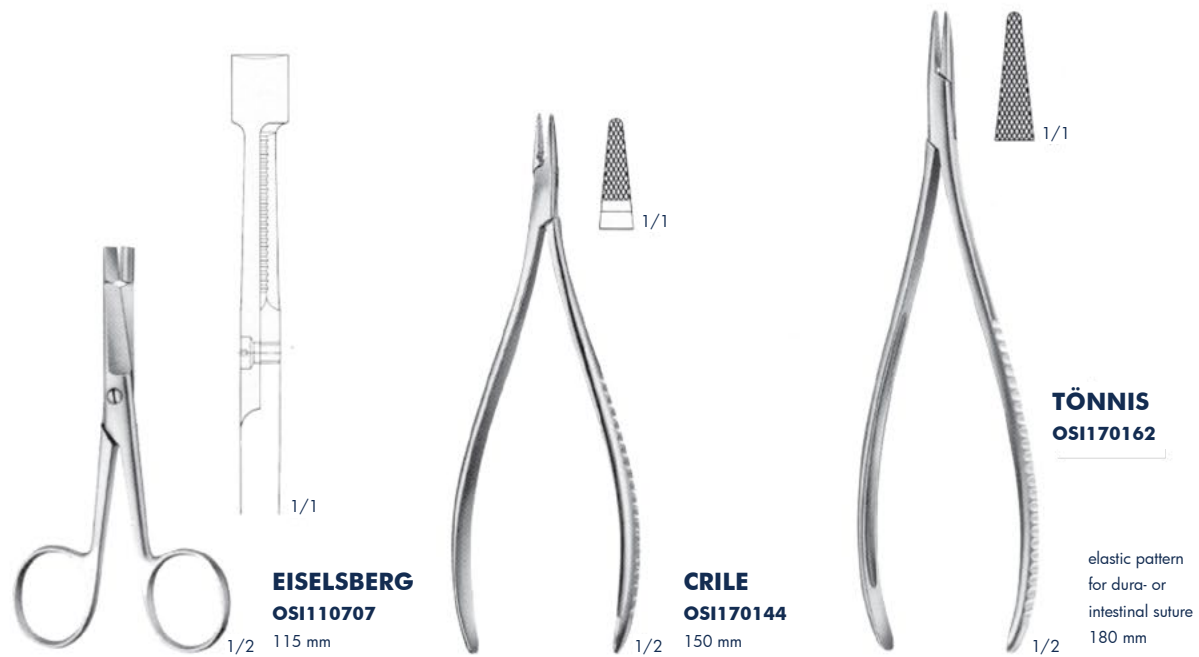
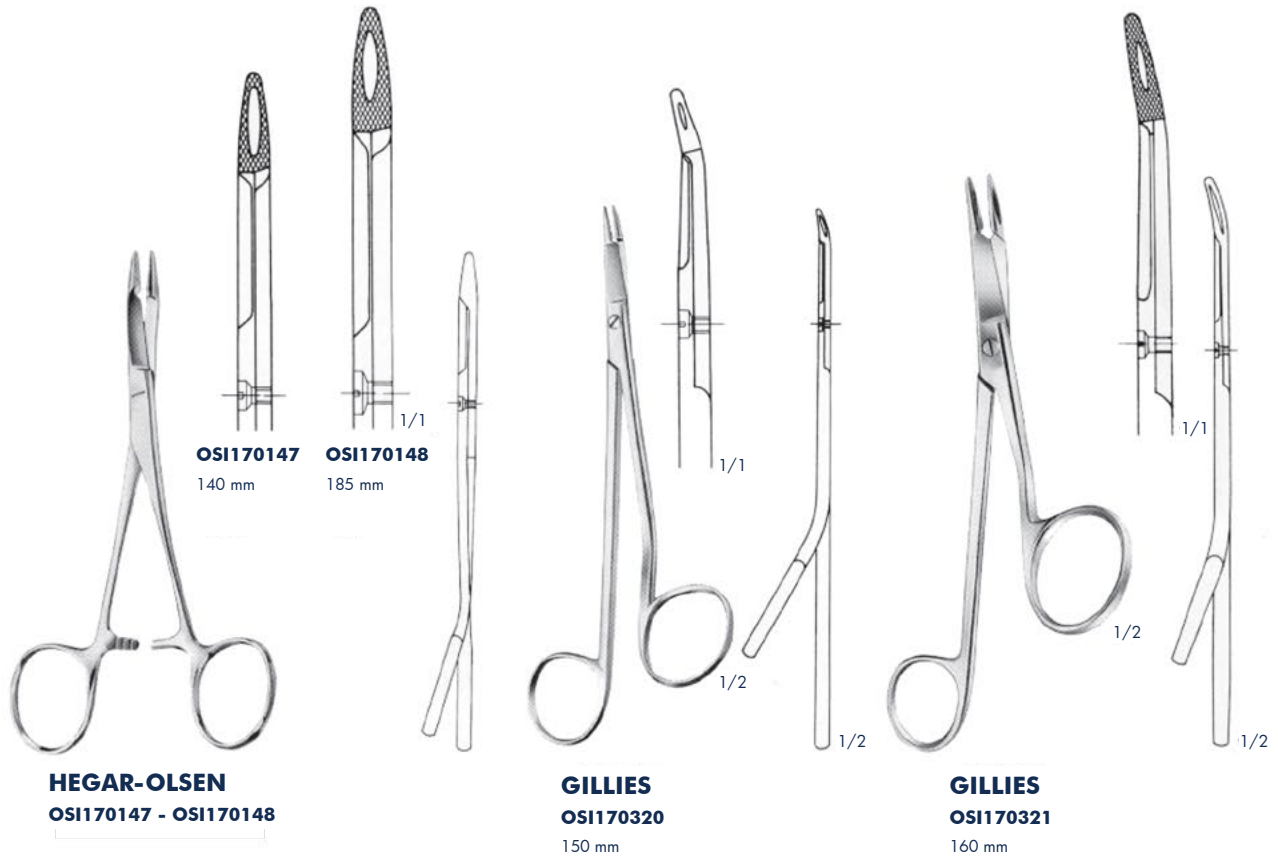

Needle Holders



MATHIEU

OSI170155 - OSI170157



OSI170155
140 mm



OSI170156
170 mm



OSI170157
200 mm 1/1



MATHIEU-STILLÉ

OSI170322 - OSI170323

very heavy patterns



OSI170322
145 mm



OSI170323
200 mm 1/1



BOYNTON

OSI170324

125 mm



1/1

1/2

Needle Holders

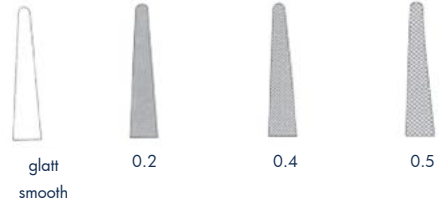

needle holders have jaws with carbide inserts and According to the use required the reps. structure can be chosen. A smooth jaw surface as well as 3 different serrations guarantee a sure „grip“ of the resp. needle.

We recommend carbide inserts with smooth jaw surface for suture material with 0.2 mm pitch of serration for suture material
0.4 mm
0.5 mm

9/0 - 11/0
6/0 - 10/0
4/0 - 6/0
up to 3/0



Needle Holders with carbide inserts
Identification:
gold-plated rings, handle ends and ratchets



with smooth jaws

CASTROVIEJO
OSI170165
145 mm



CASTROVIEJO
OSI170325
145 mm



WACHTEL
OSI170326
170 mm



OSI170166
180 mm



CASTROVIEJO
OSI170167
215 mm

Needle Holders

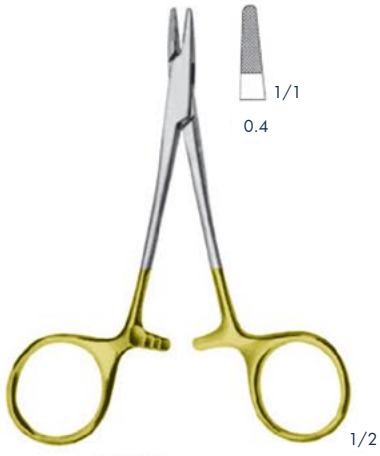

DERF
OSI170174
115 mm



HALSEY
OSI170180
120 mm



MOSING
OSI170171
one ring angled
130 mm



CONVERSE
OSI170327
130 mm

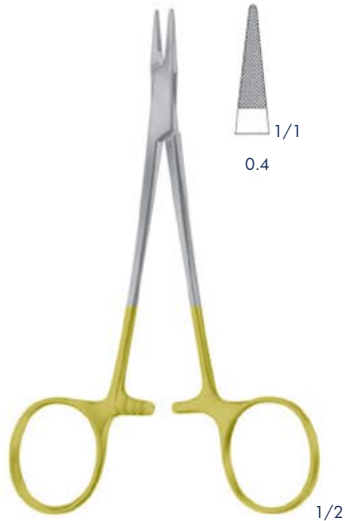

HALSEY
OSI170328
130 mm



WEBSTER
OSI170173 - OSI170329
125 mm

Needle Holders

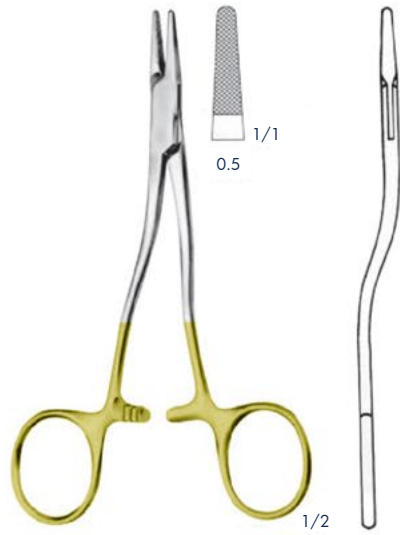

KILNER
OSI170330
 135 mm



BAUMGARTNER
OSI170179
 145 mm



BABY-CRILE-WOOD
OSI170331
 150 mm



OSI170332 145 mm **OSI170333** 180 mm **OSI170334** 200 mm **OSI170335** 305 mm

CRILE-WOOD
OSI170332 - OSI170335

Needle Holders



OSI170175
175 mm

OSI170177
260 mm

SAROT
OSI170175 - OSI170177

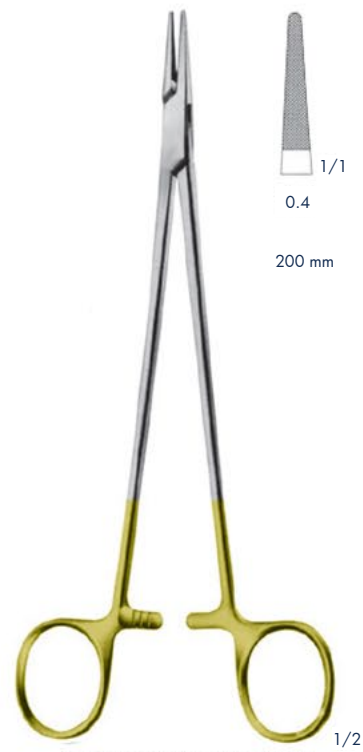

HEGAR-MAYO-SEELEY
OSI170336



OSI170190 150 mm **OSI170191** 180 mm **OSI170192** 205 mm **OSI170195** 300 mm

HEGAR-MAYO
OSI170190 - OSI170195



OSI170217
205 mm

OSI170218
245 mm

HEGAR-MAYO
OSI170217 - OSI170218
heavy patterns

Needle Holders

Needle Holder with scissors,
one blade fine serrated

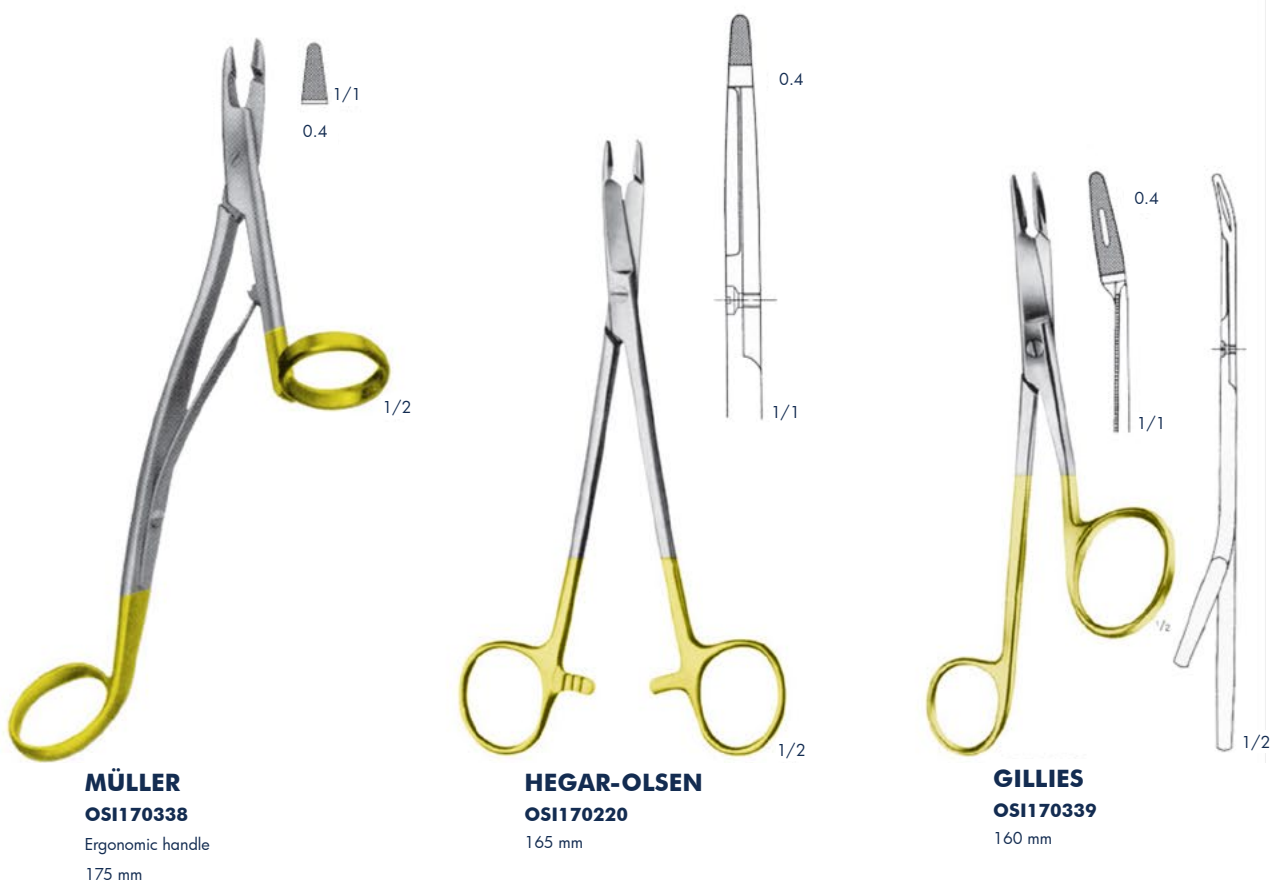
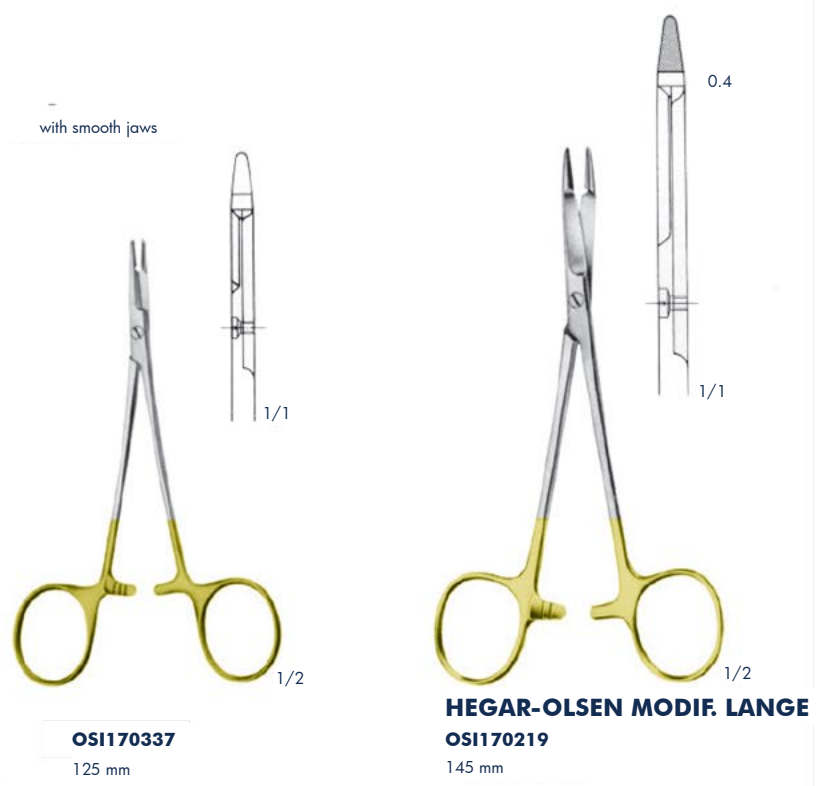

Needle Holders

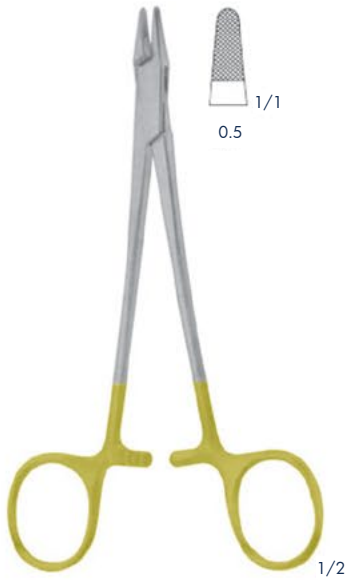

OS1170340
Wire twister, Ligature forceps
150 mm

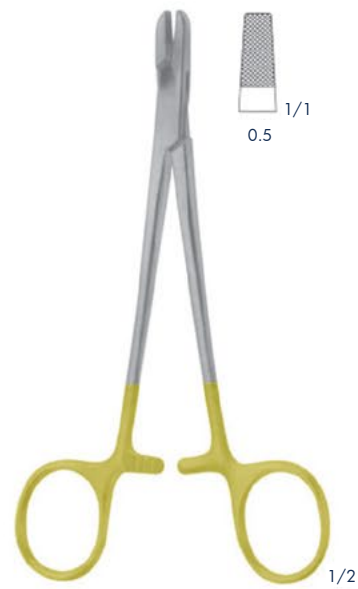

OS1170341
Wire twister, Ligature forceps
150 mm

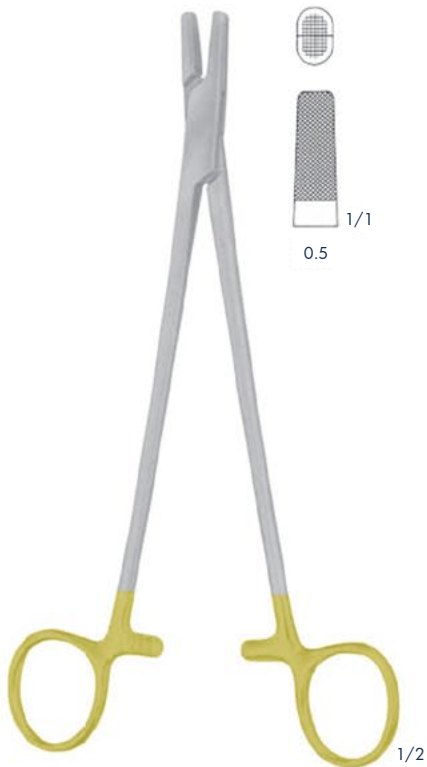

BAUMGARTNER
OS1170342
Wire twister, Ligature forceps
200 mm



OS1170343
Wire twister, Ligature forceps
175 mm

Needle Holders



DE BAKEY

OSI170344 - OSI170347

very delicate



OSI170348 - OSI170350

very delicate

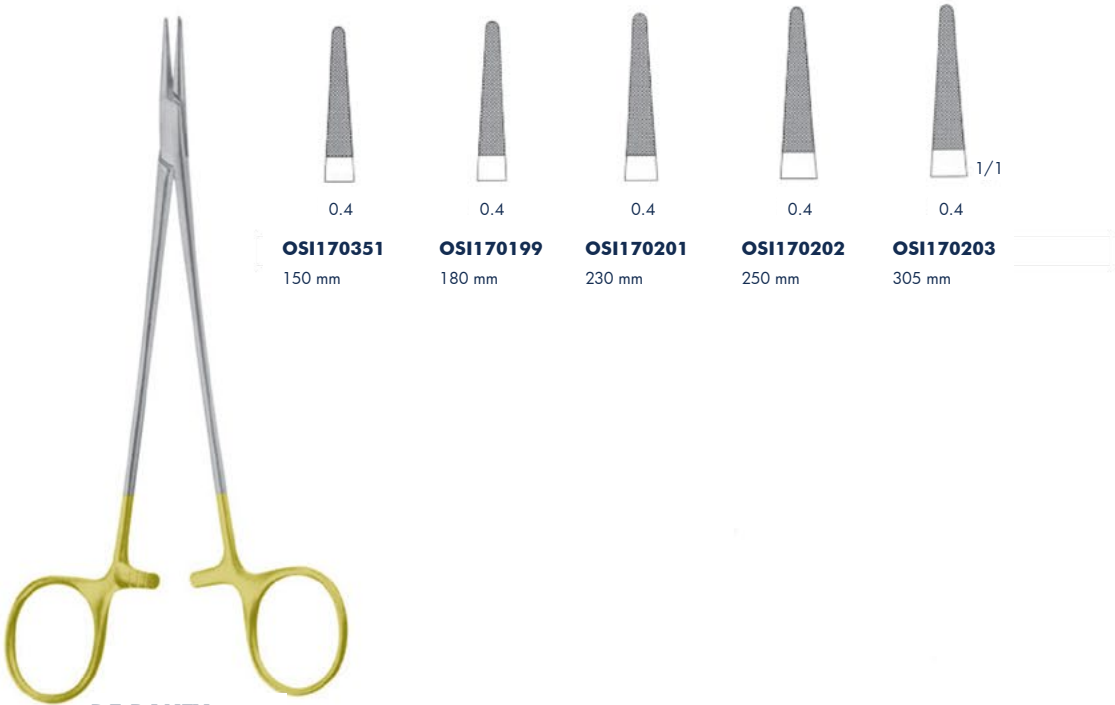

DE BAKEY

OSI170351 - OSI170203

Needle Holders



DE BAKEY
OSI170352
slender pattern
305 mm

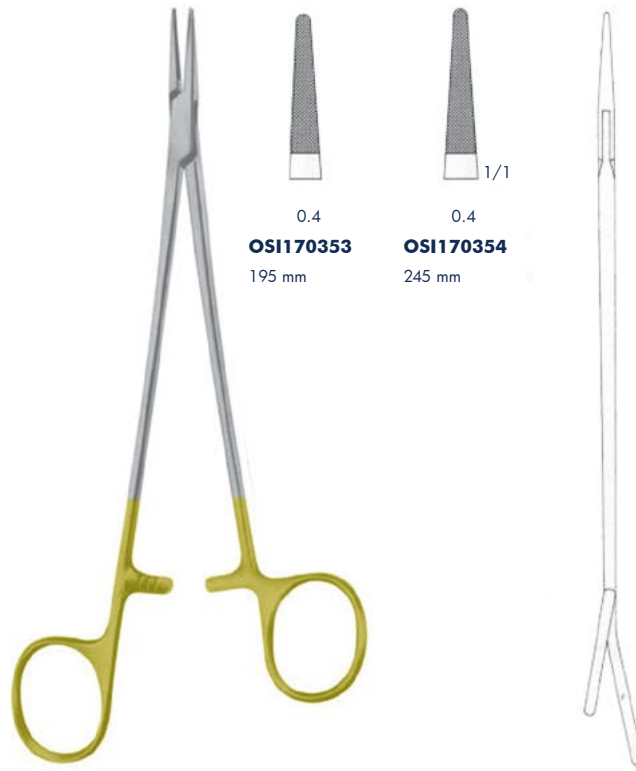

DE BAKEY
OSI170353 - OSI170354
one extended handle and curved
rings ensure optimum grip

Needle Holders



WERTHEIM
OSI170355 - OSI170357

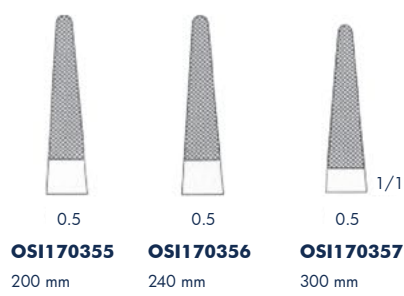

STRATTE
OSI170358 - OSI170359



JULIAN
OSI170360
200 mm



HEANEY
OSI170196 - OSI170198

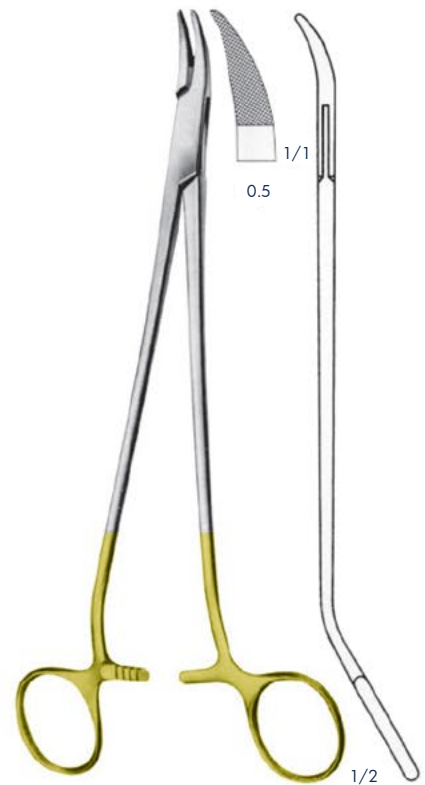

OSI170361
215 mm



Needle Holders

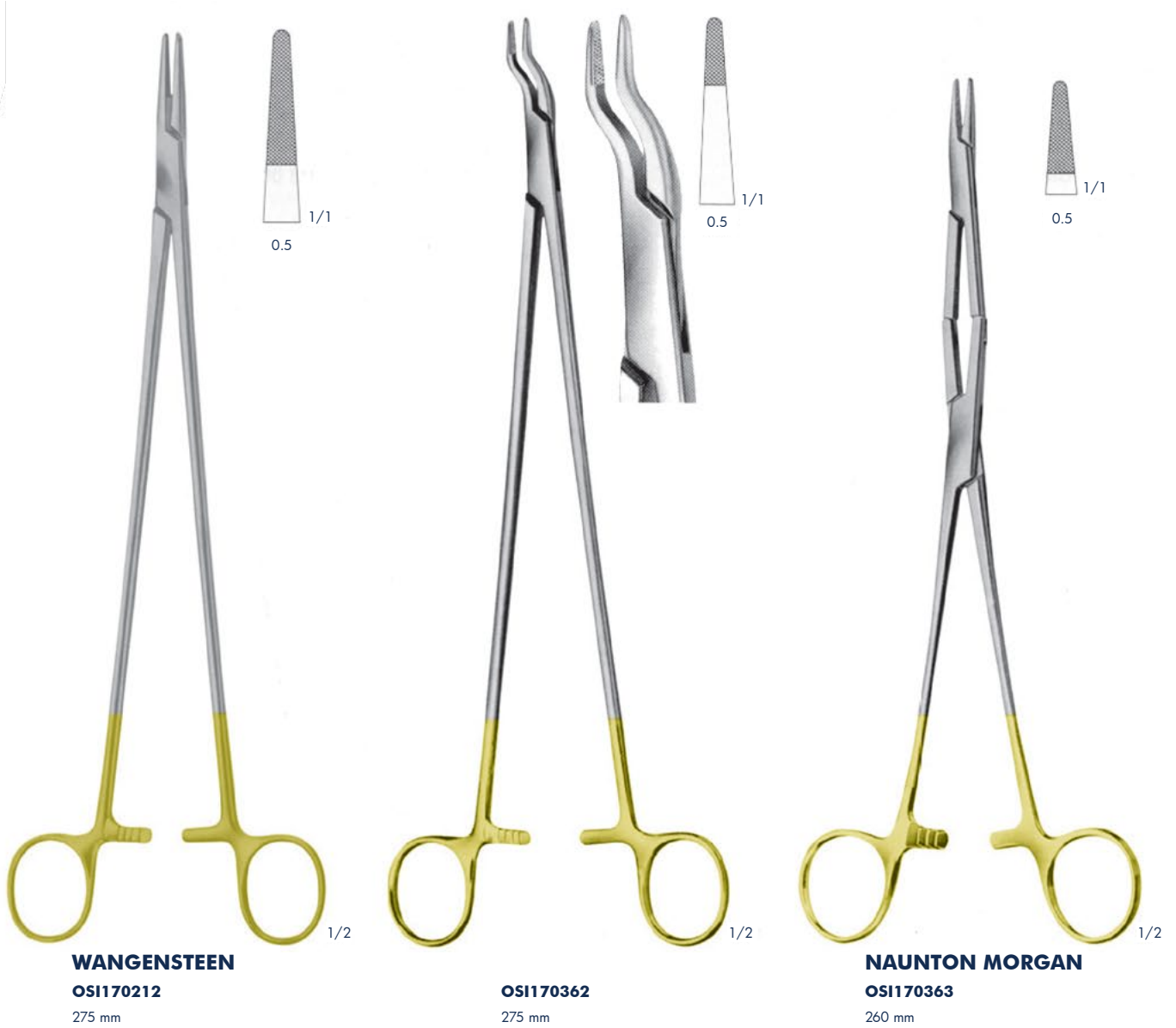

WANGENSTEEN
OSI170212
275 mm

OSI170362
275 mm

NAUNTUN MORGAN
OSI170363
260 mm

Needle Holders

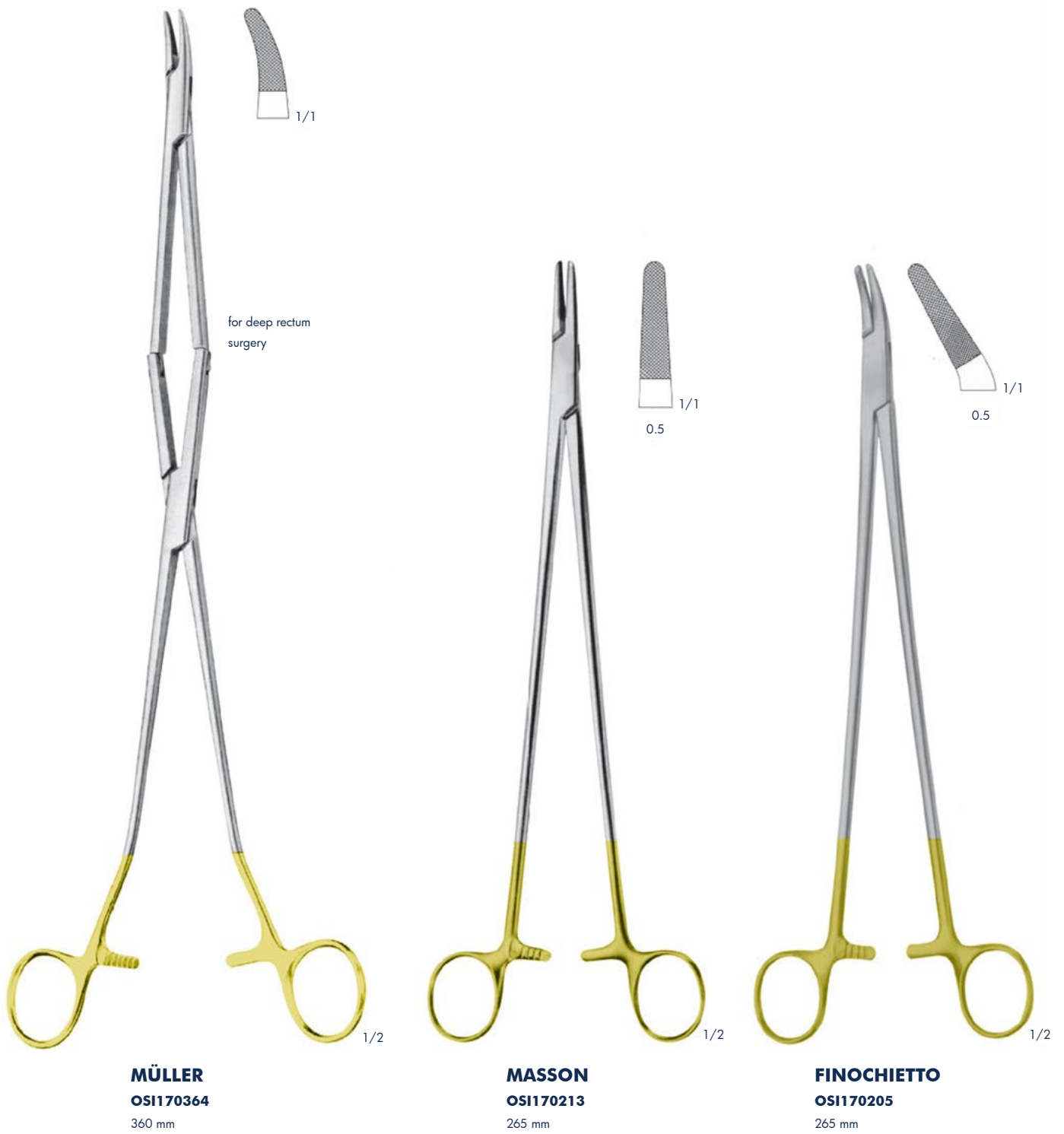

Needle Holders

These special patterns with extremely fine jaws are suitable for holding non-traumatic needles and fine vein needles.



RYDER
OSI170365 - OSI170367
 with smooth jaws



OSI170368
 200 mm



RYDER
OSI170184 - OSI170187
 very delicate



RYDER
OSI170206 - OSI170211

Needle Holders



HELLBERG/KUPKA
OSI170369
 210 mm



REIN/KUPKA
OSI170370
 190 mm



REIN/KUPKA
OSI170371
 Needle holder with catch
 190 mm

These instruments provide the surgeon with a maximum of ergonomical comfort. The optimized design of the Instruments offers a fatigue-free working especially with regard to difficult suture and anastomosis techniques.

For further details see leaflet

Needle Holders



AXHAUSEN
OSI170372
 185 mm



TÖNNIS MODIF.
OSI170223
 elastic pattern
 180 mm



TÖNNIS MODIF.
OSI170373
 elastic pattern
 180 mm



LANGENBECK
OSI170374 - OSI170375

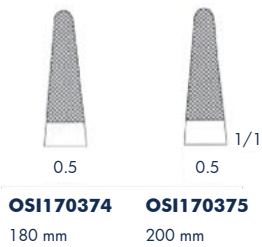

LANGENBECK
OSI170376
 200 mm

Needle Holders



OSI170377 200 mm
OSI170378 230 mm

ZWEIFEL
OSI170377 - OSI170378



ZWEIFEL
OSI170379
 heavy pattern
 for sternum suture
 200 mm



OSI170380
 200 mm

Needle Holders



LICHTENBERG
OSI170224
 elastic pattern
 195 mm



OSI170381 **OSI170382**
 205 mm 260 mm

OSI170381 - OSI170382
 with long neck



HÖSEL
OSI170383
 with long neck
 260 mm

Needle Holders



0.4

OSI170384
140 mm



0.4

OSI170385
170 mm



0.4

OSI170386
200 mm

MATHIEU

OSI170384 - OSI170386

delicate pattern



0.5

OSI170387
140 mm



0.5

OSI170388
170 mm



0.5

OSI170389
200 mm

MATHIEU-STANDARD

OSI170387 - OSI170389



0.5

OSI170390
200 mm



0.5

OSI170391
245 mm

MATHIEU

OSI170390 - OSI170391

heavy patterns

Boomerang Needle Holders

Sakrospinöz Fiksasyon Aleti; Jinekolojik cerrahide pelvik organ prolapsusu tedavisi için sakrospinöz fiksasyon ameliyatında, geniş cerrahi diseksiyona gerek kalmadan minimum doku travması ile ipliği o bölgeden geçirme özelliğine sahiptir.

Sacrospinous fixation instruments; It has the ability to pass the thread from the tissue by minimal tissue trauma without requiring extensive surgical dissection in gynecologic surgery for the treatment of pelvic organ prolapse in Sacrospinous fixation surgery.



OSI170903

Sakrospinöz fiksasyon aleti
Sacrospinous fixation instruments
30 mm

1/2



1/2

YOUNG-HRYNTSCHAK

OSI170392

with 1 needle
240 mm



1/2

YOUNG-MILLIN

OSI170393

with 1 needle
200 mm

Spare needles



1/1

OSI170394



1/1

OSI170395



1/1

OSI170396



1/2

MILLIN

OSI230430

Ligature holding forceps
245 mm

Suture Instruments - Reverdin Needles



REVERDIN
OSI170229 - OSI170232
 195 mm

REVERDIN
OSI170233 - OSI170235
 220 mm

Suture Instruments - Ligature Needles



KRONECKER
OS1170397
 for right hand
 bunt
 155 mm



KRONECKER
OS1170398
 for left hand
 bunt
 155 mm



DESCHAMPS
OS1170399
 for right hand
 steep turn blunt
 255 mm



DESCHAMPS
OS1170400
 for left hand
 steep turn blunt
 255 mm



DESCHAMPS
OS1170401
 for right hand
 steep turn blunt
 255 mm



DESCHAMPS
OS1170402
 for left hand
 steep turn blunt
 255 mm

Suture Instruments - Ligature Needles



Suture Instruments - Ligature Needles



DESCHAMPS
OSI170240
 for right hand
 bunt
 215 mm

DESCHAMPS
OSI170241
 for left hand
 bunt
 215 mm

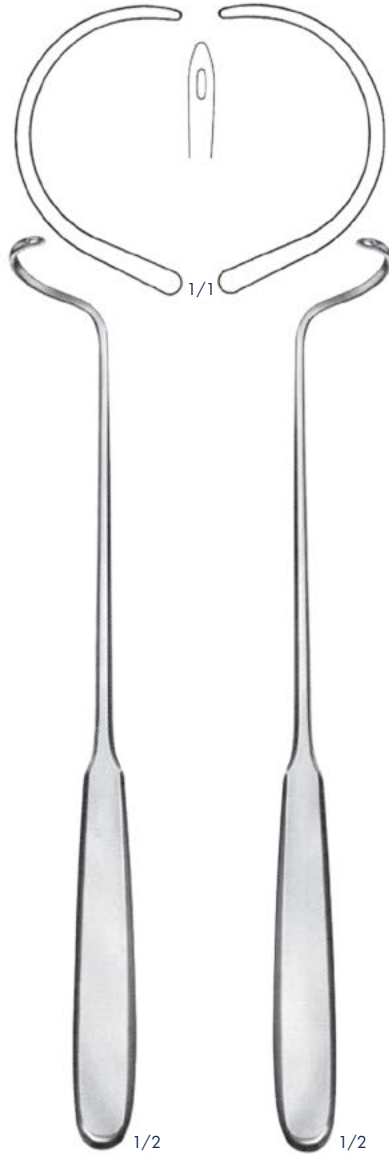

DESCHAMPS
OSI170238
 for right hand
 bunt
 240 mm

DESCHAMPS
OSI170239
 for left hand
 bunt
 240 mm

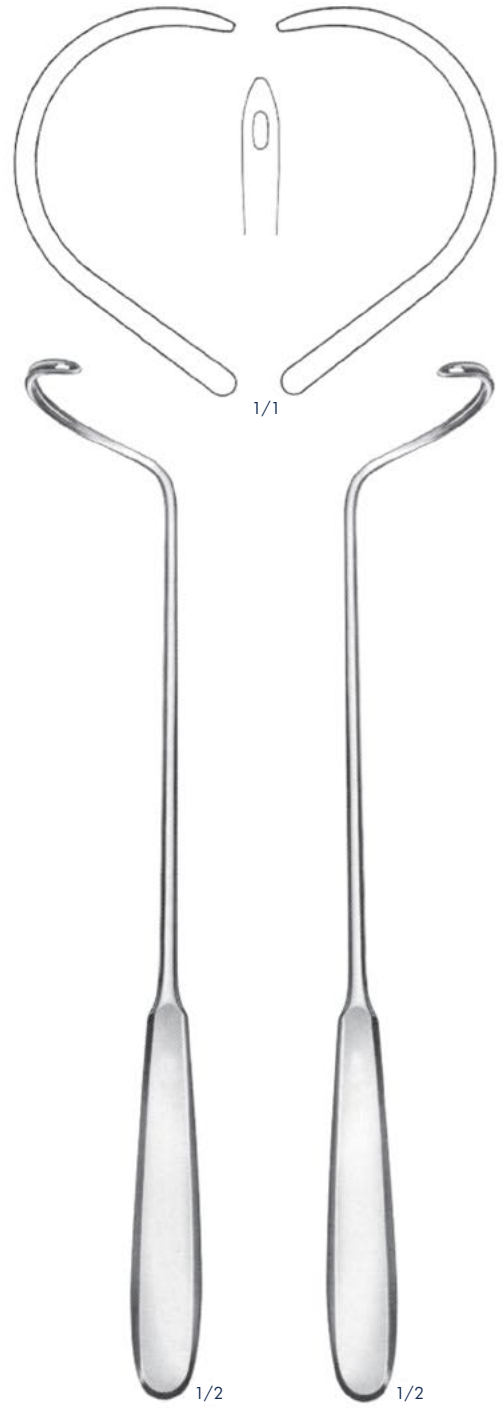

DESCHAMPS
OSI170246
 for right hand
 bunt
 280 mm

DESCHAMPS
OSI170247
 for left hand
 bunt
 280 mm

Suture Instruments - Ligature Needles



HURD
OS1170409
 for right hand
 sharp
 210 mm



HURD
OS1170410
 for left hand
 sharp
 210 mm



DESCHAMPS
OS1170411
 for right hand
 sharp
 205 mm



DESCHAMPS
OS1170412
 for left hand
 sharp
 205 mm



DESCHAMPS
OS1170413
 for right hand
 sharp
 210 mm



DESCHAMPS
OS1170414
 for left hand
 sharp
 210 mm

Suture Instruments - Ligature Needles

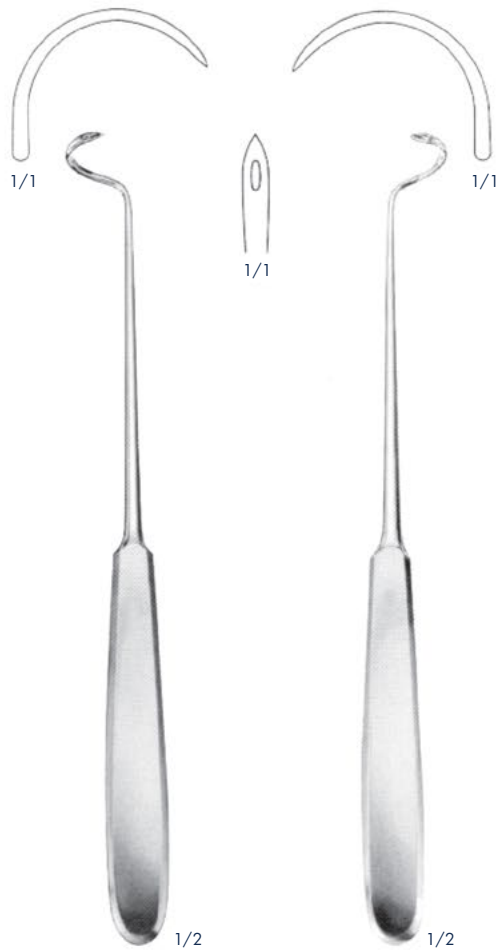

DESCHAMPS

OSI170242

for right hand
sharp

215 mm



DESCHAMPS

OSI170243

for left hand
sharp

215 mm



JONESCO

OSI170415

Needle for wire
suture

185 mm



CLAUS VAN EICKEN

OSI260113

250 mm

Ligature Needles

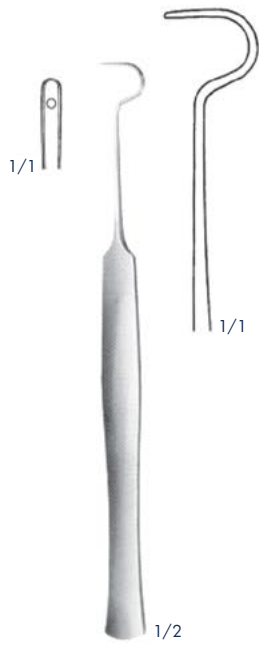

OSI170416
150 mm

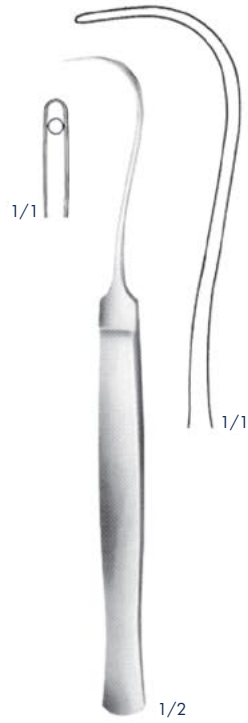

SYME
OSI170417
170 mm



COOPER
OSI170418
205 mm

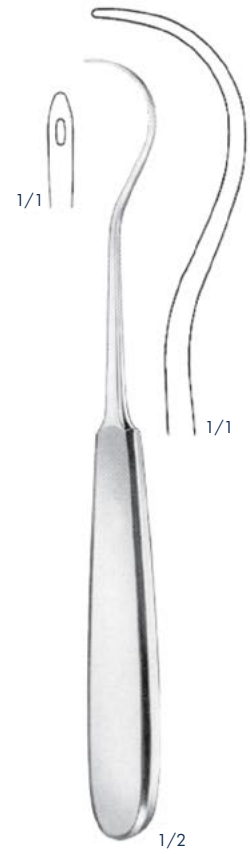

KOCHER
OSI170419
205 mm

Ligature Needles



BRUNNER
OSI170420
240 mm



OSI170421
malleable
230 mm



SCHMIEDEN-DICK
OSI170422
malleable
320 mm

BRUNNER Ligature Needles, Guiding Probes

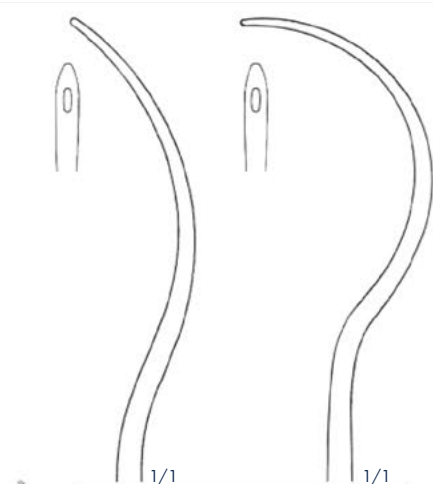

OSI170250

OSI170251



1/2

BRUNNER
OSI170250 - OSI170251

Ligature needles
300 mm

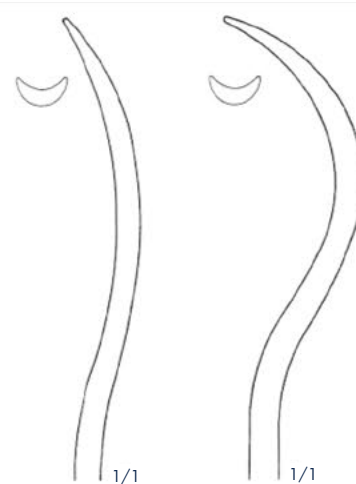

OSI170252

OSI170253



1/2

BRUNNER
OSI170252 - OSI170253

Guiding probes
300 mm

Guiding Probes



OSI170423
200 mm



KOENIG
OSI170258
195 mm



KOENIG
OSI170259
200 mm



SCHMIEDEN
OSI170256
185 mm



KOCHER
OSI220130
150 mm



KOCHER
OSI220131
170 mm



PAYR
OSI170424
195 mm



PAYR
OSI170261
225 mm

Guiding Probes



OSI170255
280 mm

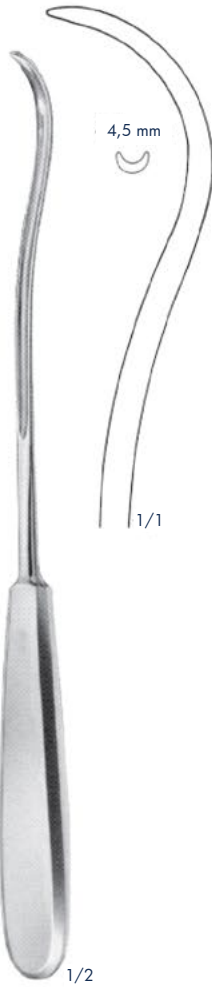

KIRSCHNER
OSI170549
255 mm



OSI170425
240 mm



OSI170426
185 mm



OSI170427
265 mm

Suture Instruments



OSI170428
Knot tier and
ligature adjuster
230 mm



CASPAR
OSI170429
Knot tier and
ligature adjuster
230 mm



WIENER MODELL
OSI170430
Suture hook
235 mm

Probes

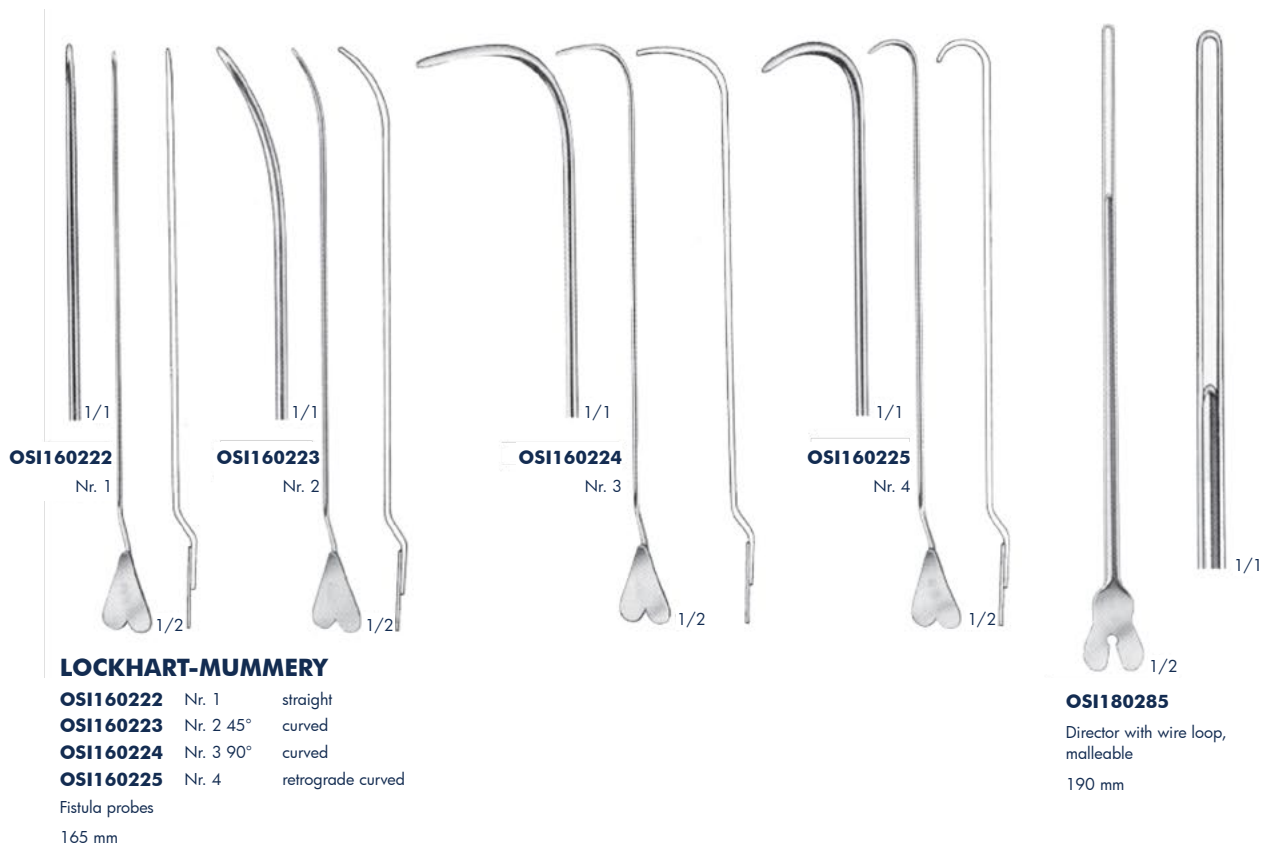

Probes



OSI160119
2,5 mm Ø
OSI160120
2,5 mm Ø
OSI160121
3,0 mm Ø

OSI160119 145 mm
OSI160120 160 mm
OSI160121 200 mm
Probes with eye



Ø 1,5 mm

1/2
OSI160227
Myrtle leaf probe
145 mm



Ø 2,0 mm

OSI160128 130 mm
OSI160127 145 mm
OSI160128 160 mm
OSI160229 180 mm
OSI160129 200 mm
Myrtle leaf probes



diam. of tips	1 mm	1,5 mm	2 mm	Length
-		OSI160108	-	130 mm
OSI160114		OSI160109	OSI160103	145 mm
-		OSI160110	OSI160104	160 mm
-		OSI160111	OSI160105	180 mm
-		OSI160112	OSI160106	200 mm
-		OSI160113	-	250 mm
-		-	OSI16456	300 mm

Probes



1/2
OSI160230
Sinus probe
diam. of tip 1.2 mm
150 mm



1/2
OSI160141
Double ended probe,
malleable, diam. of tips
3 mm with hole
190 mm

Probes



OSI160142 250 mm
OSI160231 300 mm
Double ended probes,
tin, malleable,
diam. of tips 3.5 mm



OSI160232 400 mm
Double ended probe,
tin, malleable,
diam. of tips 4 mm



OSI160233 1,5 mm
OSI160234 2,0 mm
OSI160235 2,5 mm
Probes
300 mm

Probes - Spatulas - Cotton Applicators



1/2

STACKE

OSI160126

Ø 0,8 mm
silver
100 mm



1/2

CAWTHORNE

OSI160236

flattened end
silver
140 mm



1/2

KILLIAN

OSI160237

Ø 1,5 mm
165 mm



1/2

OSI160238

Ø 1,4 mm
160 mm



1/2

SEIFFERT

OSI160239

Ø 1,0 mm
silver
180 mm



1/2

BOWMAN

OSI160240

0,7 + 0,8 mm Ø, Fig. 00/0
OSI160241 0,9 + 1,1 mm Ø, Fig. 1/2
OSI160242 1,3 + 1,4 mm Ø, Fig. 3/4
OSI160243 1,5 + 1,6 mm Ø, Fig. 5/6
OSI160244 1,8 + 1,9 mm Ø, Fig. 7/8
130 mm



1/2

OSI160245

Spatula
145 mm



1/2

OSI250764

Spatula
145 mm



1/2

MODELL PICCOLO

OSI250933 Ø 0,7 mm

round serrated end
110 mm



1/2

MODELL PICCOLO

OSI250934 Ø 0,7 mm

triangular serrated end
110 mm



1/1

FARREL

OSI160246 Ø 1,2 mm

round serrated end
110 mm



1/1

LATHBURY-FARREL

OSI160247 Ø 1,4 mm

triangular serrated end
110 mm



1/1

Cotton Applicators



BUCK
OSI250922 Ø 0,9 mm
 rough, spiral end
 120 mm



OSI160173 Ø 0,9 mm
 triangular serrated end
 140 mm

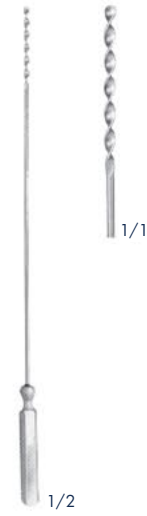

LOGAN TURNER
OSI160248 Ø 1,0 mm
 rough, spiral end
 135 mm



KINGS'S COLLEGE HOSPITAL
OSI160249
 rough, spiral end
 90 mm



KINGS'S COLLEGE HOSPITAL
OSI160250
 rough, spiral end
 135 mm



OSI250923 Ø 1,0 mm
 rough, spiral end
 140 mm



OSI250924 Ø 1,2 mm
 rough, spiral end
 140 mm



OSI160251 Ø 1,8 mm
 rough, spiral end
 140 mm

Cotton Applicators



FARRELL
OSI160168 Ø 1,2 mm
round serrated end
140 mm



LATHBURY-FARRELL
OSI160169 Ø 1,4 mm
triangular serrated end
140 mm



FARRELL
OSI260359 Ø 1,2 mm
rough, spiral end
160 mm



LATHBURY-FARRELL
OSI160252 Ø 1,2 mm
triangular serrated end
160 mm



OSI160253 Ø 1,4 mm
triangular serrated end
160 mm

Cotton Applicators



OS1160254 Ø 1,5 mm
rough, spiral end
180 mm



OS1160255 Ø 1,8 mm
rough, spiral end
180 mm



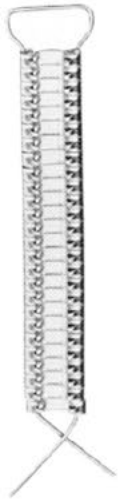

HARTMANN
OS1160256 Ø 2,3 mm
rough, spiral end
220 mm

Suture Clips



MICHEL
OSI160257 - OSI160264

	Size mm	
OSI160257	7,5 x 1,75	
OSI160258	11 x 2	
OSI160259	12 x 2,5	
OSI160260	14 x 3	
OSI160261	16 x 3	
OSI160262	18 x 3	
OSI160263	20 x 3	
OSI160264	22 x 3	 1/1

MICHEL Suture Clips, stainless steel
Sales unit: PH = 1 Package of 100 pieces

Clip Applying Forceps - Suture Set



1/2

MICHEL
OSI130370
125 mm



1/2

HEGENBARTH
OSI130368
120 mm



1/2

WACHENFELDT
OSI130369
120 mm

Clip Applying- and Removing Forceps



MICHEL
OSI160265
125 mm

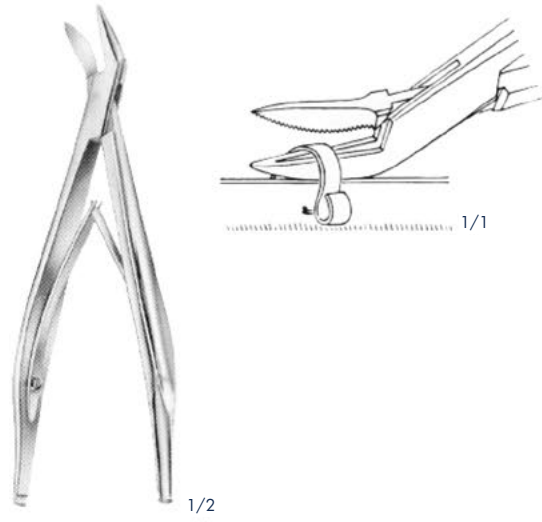

MICHEL MODIF.
OSI160266
130 mm



HEATH
OSI160267
135 mm



COLLIN
OSI160268
135 mm

REDON-Guide needles



Charr. Knife tip

- slightly curved
- 8 **OSI160269**
- 10 **OSI160270**
- 12 **OSI160271**
- 14 **OSI160272**
- 16 **OSI160273**
- 18 **OSI160274**

Knife tip

- strongly curved
- OSI160275**
- OSI160276**
- OSI160277**
- OSI160278**
- OSI160279**
- OSI160280**

Lancet tip

- slightly curved
- OSI160281**
- OSI160282**
- OSI160283**
- OSI160284**
- OSI160285**
- OSI160286**

Trocar tip

- slightly curved
- OSI160287**
- OSI160288**
- OSI160289**
- OSI160290**
- OSI160291**
- OSI160292**

Nerve- and Vessel Hooks

Dimensions for blade size of retractors
 1st number = depth Example : 25 x 38 mm
 2st number = width

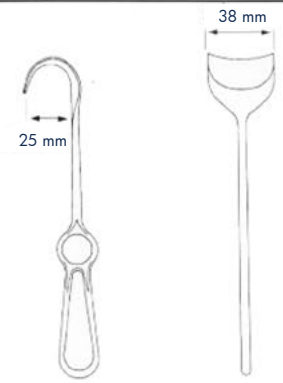

WAGENER
 OSI250353 - OSI250356
 150 mm



GRAEFE
 OSI150491 - OSI150493
 140 mm



ST. BARTS
 OSI250944
 blunt hook
 180 mm

Nerve- and Vessel Hooks



Nerve- and Vessel Hooks

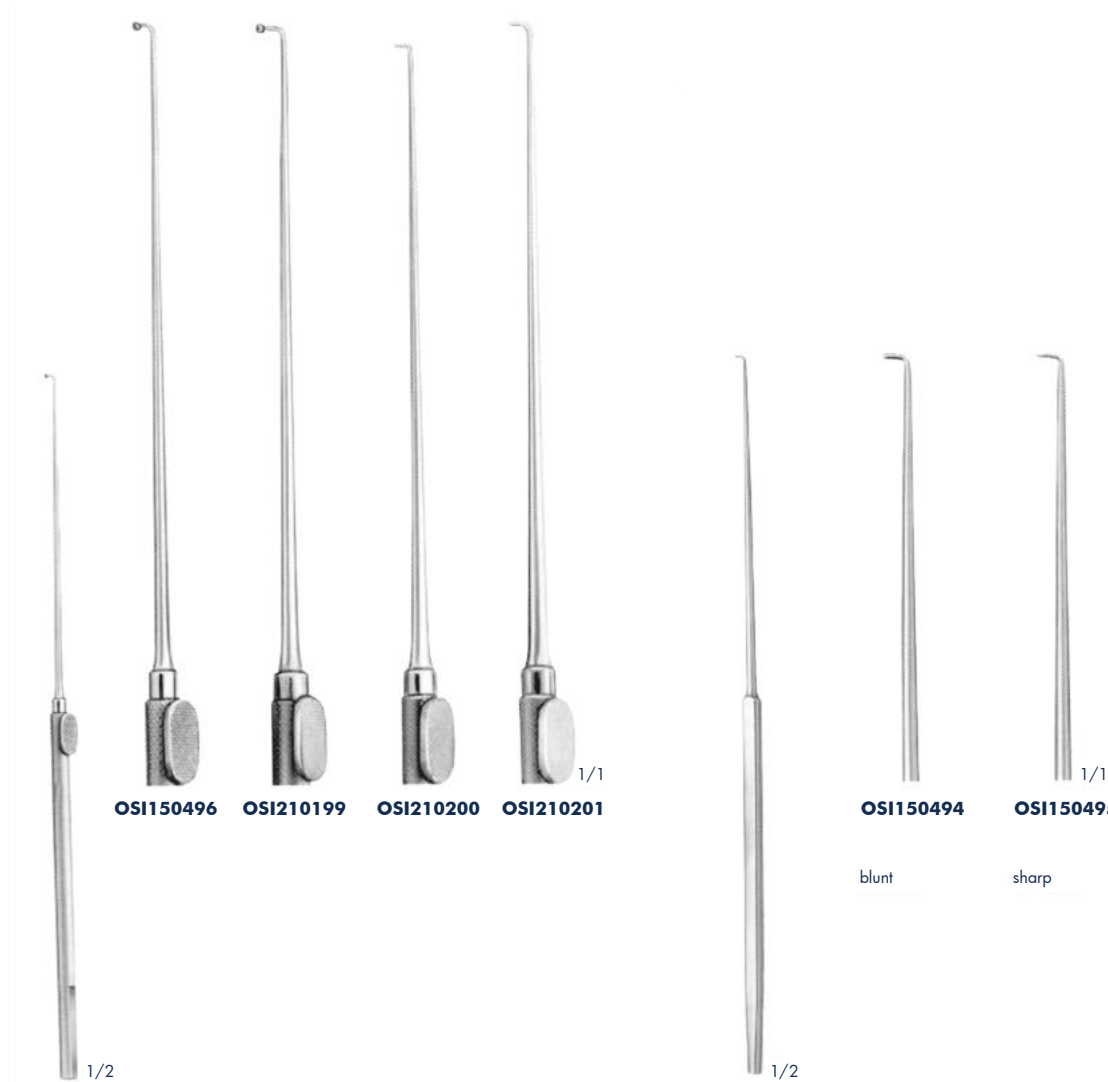

KRAYENBÜHL
OSI150496 - OSI210201
185 mm

ADSON
OSI150494 - OSI150495
190 mm

Nerve- and Vessel Hooks

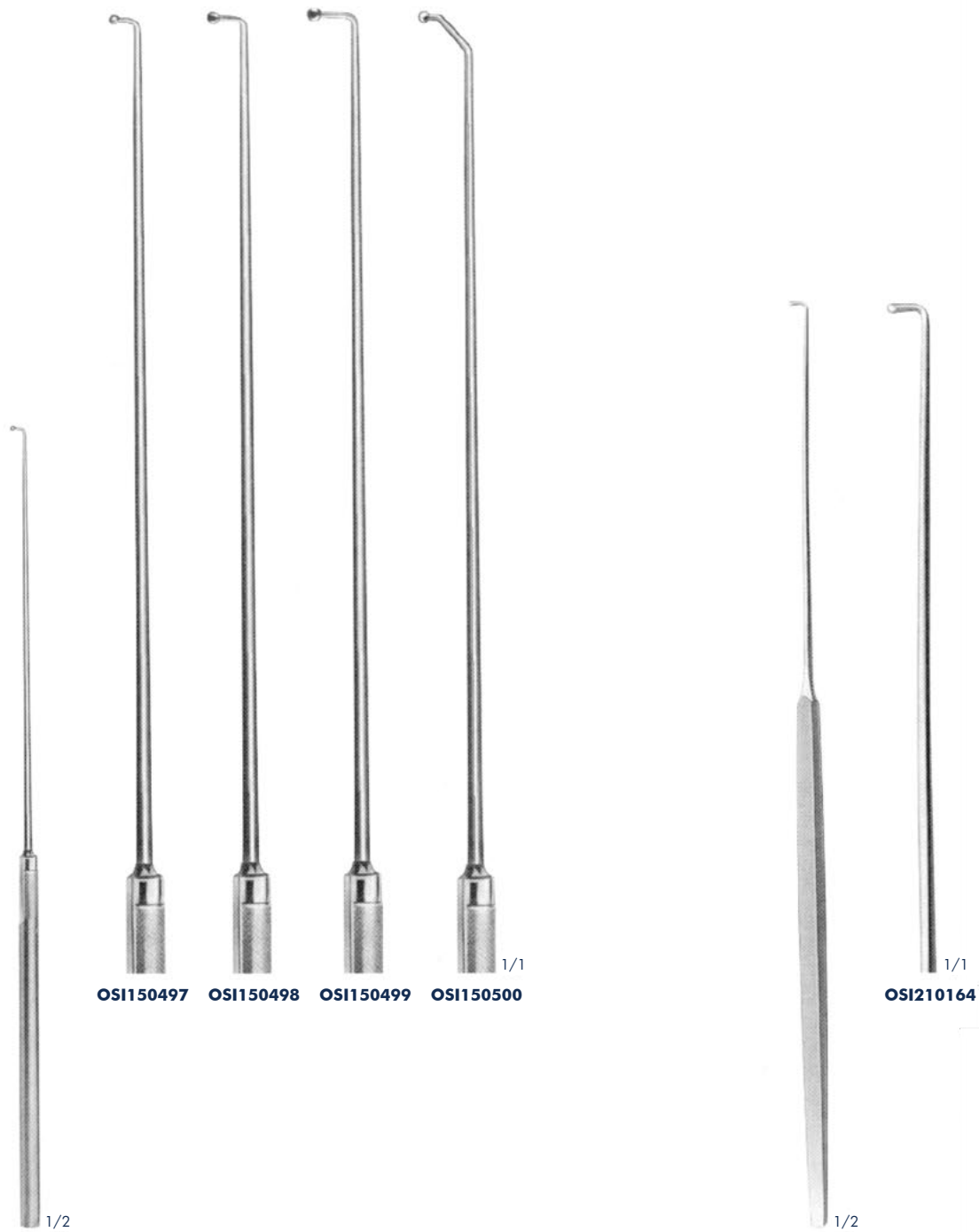









OSI150497 OSI150498 OSI150499 OSI150500 1/1



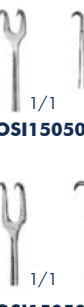







OSI210164 1/1

CASPAR
OSI150497 - OSI150500
Exploration- and coagulation hook,
probe-end, insulated
245 mm

CUSHING
OSI210164
280 mm

Fine Wound Retractors (Dura- and Skin Retractors)

 <p>1/2</p>	 <p>1/1 OSI260408 1/1 OSI260777</p>		 <p>1/1 OSI150501 1/1 OSI150502</p>		 <p>1/1 OSI150503 1/1 OSI150504 1/1 OSI150505</p>	 <p>1/2</p>	 <p>1/1</p>	 <p>1/2</p>	 <p>1/1</p>
<p>GRAEFE OSI260408 sharp OSI260777 blunt 125 mm</p>	<p>GUTHRIE OSI150501 125 mm OSI150502 130 mm sharp</p>			<p>ROLLET OSI150503 130 mm OSI150504 135 mm sharp OSI150505 135 mm blunt</p>		<p>FRAZIER OSI150506 Dura retractor 130 mm</p>		<p>TOENNIS OSI210178 Dura retractor 150 mm</p>	

 <p>1/2</p>	 <p>1/1</p>	 <p>9 mm 1/1 OSI150507 10 mm 1/1 OSI150508</p>	 <p>1/2</p>	 <p>1/2</p>	 <p>1/2</p>	 <p>1/2</p>	 <p>1/2</p>	 <p>1/1</p>	 <p>1/1</p>
<p>KILNER OSI220149 160 mm</p>	<p>MC INDOE OSI150507 - OSI150508 150 mm</p>	<p>FREER OSI250621 150 mm</p>	<p>MÜLLER OSI150509 150 mm</p>	<p>MÜLLER OSI150510 150 mm</p>	<p>COTTLE OSI250612 160 mm</p>	<p>COTTLE OSI260407 160 mm</p>			

Fine Wound Retractors (Dura- and Skin Retractors)

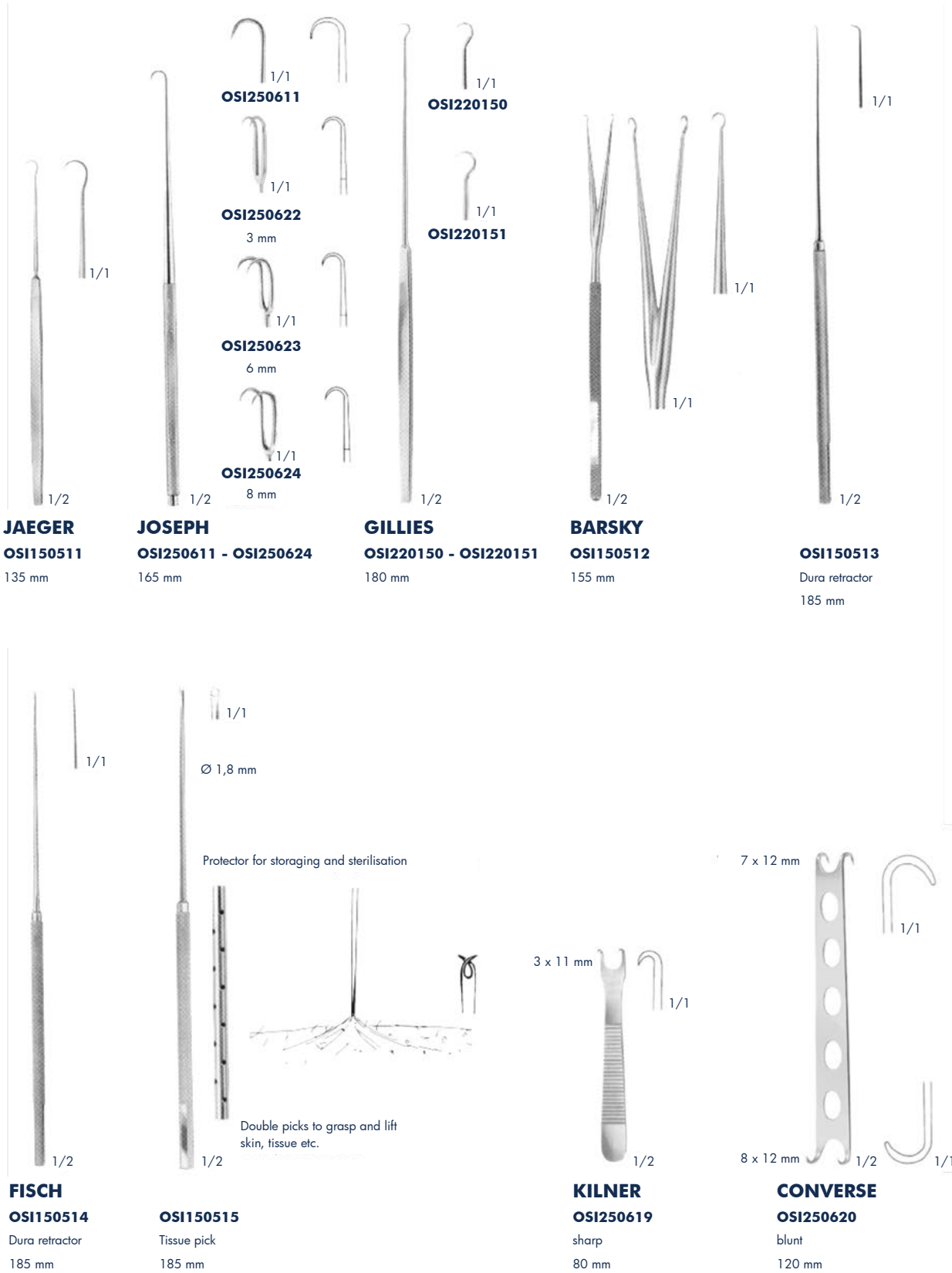

Wound- and Trachea Retractors

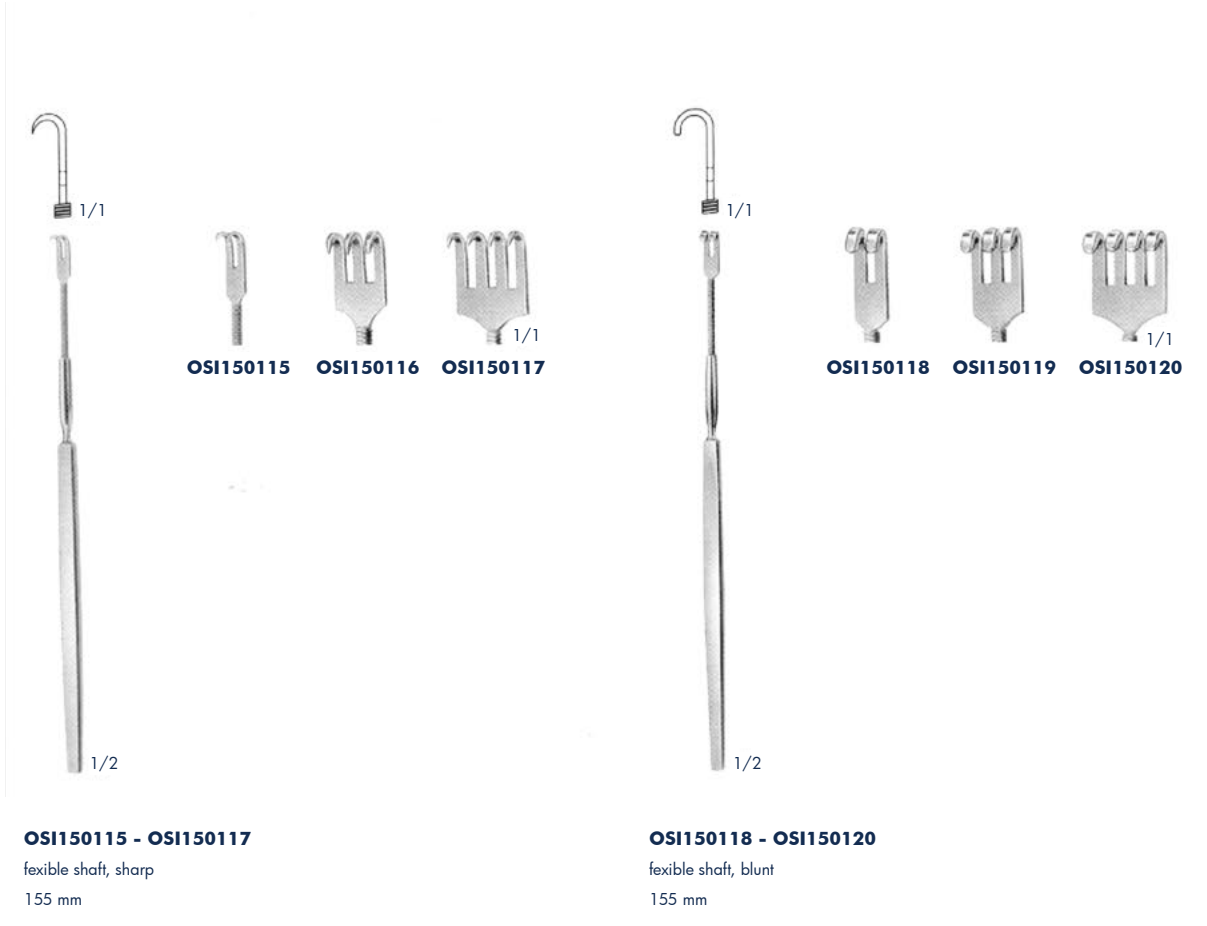
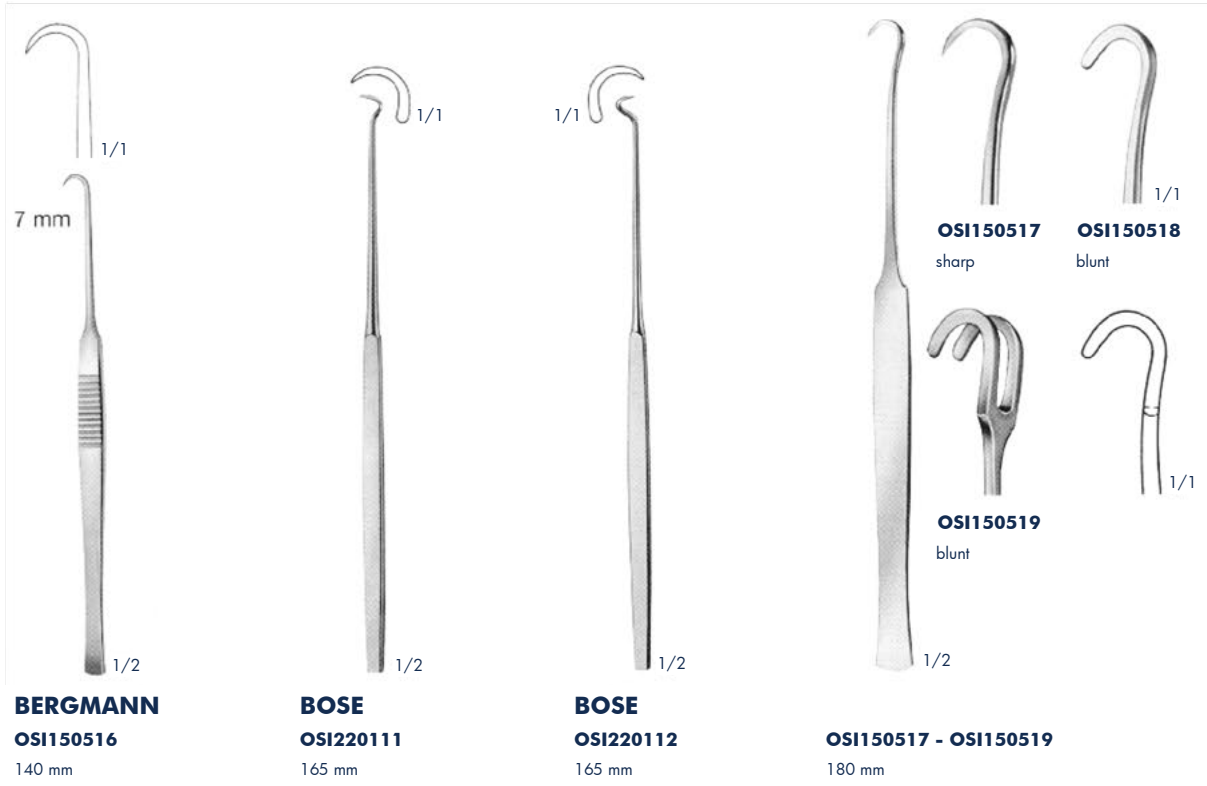

Wound- and Trachea Retractors



OSI150138 - OSI150141

small curve, sharp
165 mm

OSI150142 - OSI150145

small curve, blunt
165 mm



OSI150107 - OSI150110

large curve, sharp
165 mm

OSI150111 - OSI150114

large curve, blunt
165 mm

Retractors with treangle handle

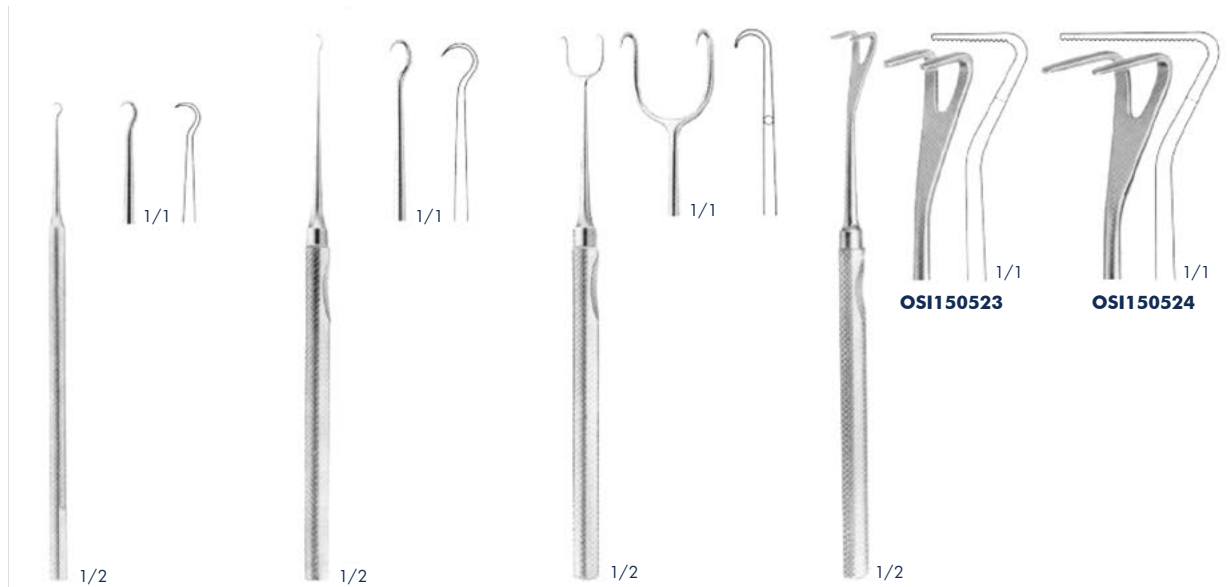

MANNERFELT MODIF.
OSI150520

sharp
135 mm

MANNERFELT MODIF.
OSI150521

sharp
155 mm

MANNERFELT MODIF.
OSI150522

sharp
155 mm

MANNERFELT MODIF.
OSI150523 - OSI150524

Forked hook, retrograded curved
155 mm



MANNERFELT MODIF.
OSI150525 - OSI150527

small curve, sharp
155 mm

MANNERFELT MODIF.
OSI150528 - OSI150530

small curve, blunt
155 mm

MANNERFELT MODIF.
OSI150531 - OSI150533

large curve, sharp
155 mm

MANNERFELT MODIF.
OSI150534 - OSI150536

large curve, blunt
155 mm

Retractors with treangle handle



MANNERFELT MODIF.
OSI150537
 flexible shaft, small curve, sharp
 155 mm



MANNERFELT MODIF.
OSI150538
 hollow grooved, 16 x 6 mm
 155 mm



LANGENBECK - MANNERFELT MODIF.
OSI150133 - OSI150136
 155 mm



MANNERFELT MODIF.
OSI150539 - OSI150541
 Saddle hooks
 155 mm



MANNERFELT MODIF.
OSI150129
 Saddle hooks, fenestrated
 155 mm

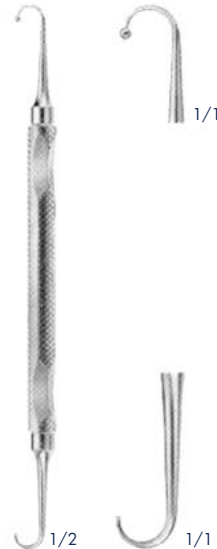

MANNERFELT MODIF.
OSI150542
 Tendon double hook
 160 mm

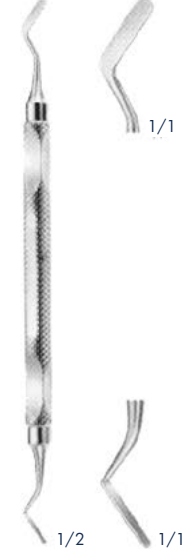

MANNERFELT MODIF.
OSI150543
 Spatula, double-ended
 160 mm

Retractors



FOMON
OSI260409
145 mm

OSI150544 - OSI150545
160 mm

LANGENBECK-GREEN
OSI150146 - OSI150147
160 mm

OSI150546
160 mm



MEYERDING
OSI150148 - OSI150548
Fig. A - Fig. F
180 mm

WILLIGER
OSI150549 - OSI150551
120 mm

Retractors



EMMET
OSI150552
 Fistula hook
 220 mm

1/2



1/1



SIMON
OSI240274
 Fistula hook
 220 mm

1/2



1/1



SIMON
OSI240275
 Fistula hook
 220 mm

1/2



1/1



LANGE
OSI250616
 Fistula hook
 230 mm

1/2



1/1

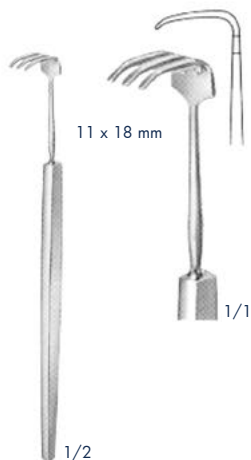

PAUL
OSI150553
 Tendon hook
 120 mm

11 x 18 mm

1/2



1/1



OSI150554 - OSI150555
 Tendon hook
 175 mm

1/2



12 x 6 mm

1/1



12 x 11 mm

1/1



KLAPP
OSI150556
 Tendon hook
 175 mm

1/2



15 x 11 mm

1/1



STRANDELL-STILLE
OSI150159 - OSI150160
 Tendon hook
 180 mm

1/2



15 x 6 mm

blunt

OSI150159

1/1



15 x 6 mm

toothed

OSI150160

1/1

Wound- and Vein Retractors

MOSING
OSI260405
140 mm

6 x 12 mm

COTTLE
OSI260406
140 mm

10 x 12 mm

DESMARRES
OSI150124 - OSI150128
140 mm

9 x 9 mm

9 x 12 mm

11 x 14 mm

12 x 16 mm

13 x 18 mm

KÖNIG
OSI150557 - OSI150558
180 mm

13 x 13 mm

10 x 10 mm

12 x 16 mm

CUSHING-KOCHER
OSI150559
175 mm

KOCHER
OSI150227 - OSI150228
205 mm

20 x 12 mm

20 x 15 mm

Wound- and Vein Retractors



20 x 15 mm

20 x 19 mm

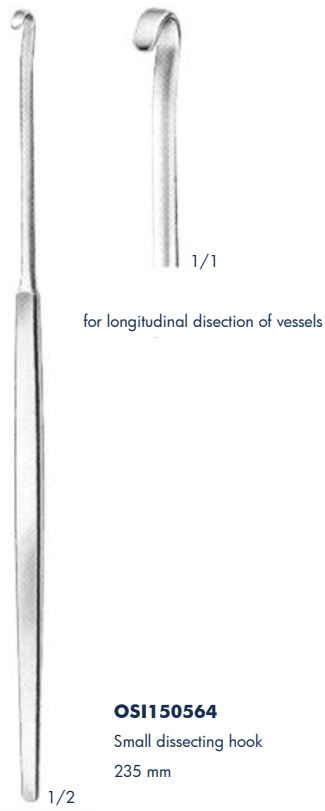

for longitudinal dissection of vessels

Retractors

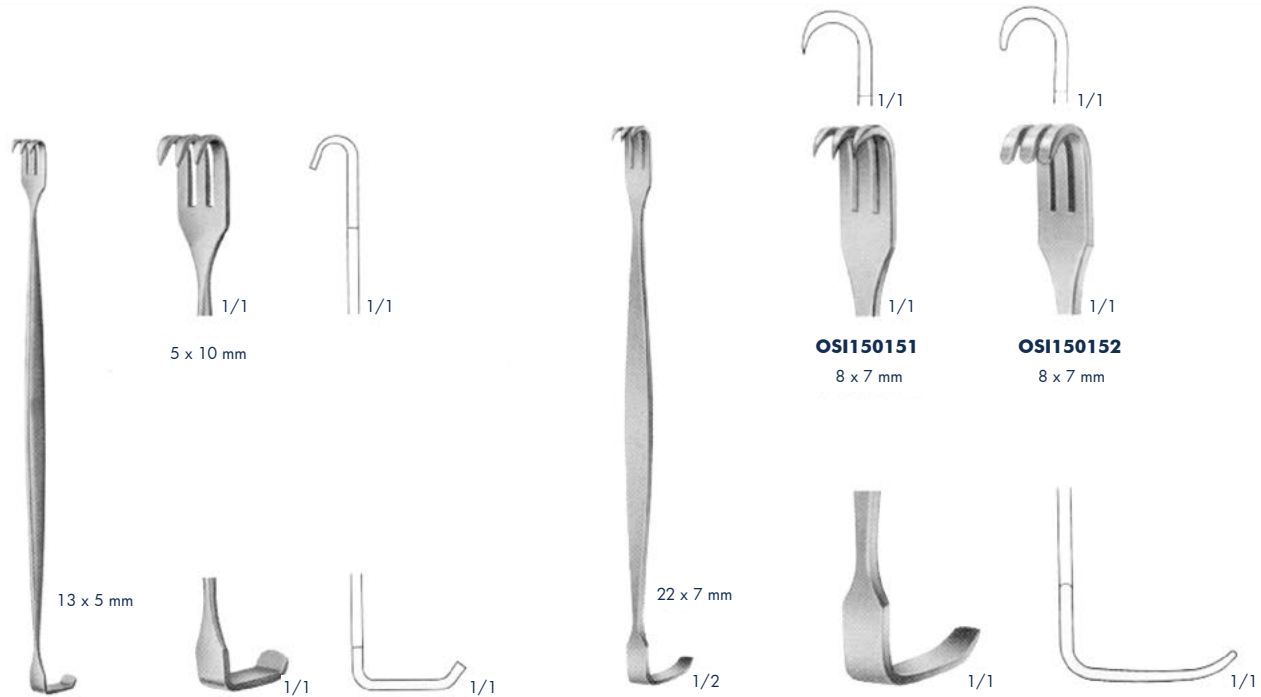

KILNER
OSI150565
155 mm

BABY-SENN-MILLER
OSI150151 - OSI150152
155 mm

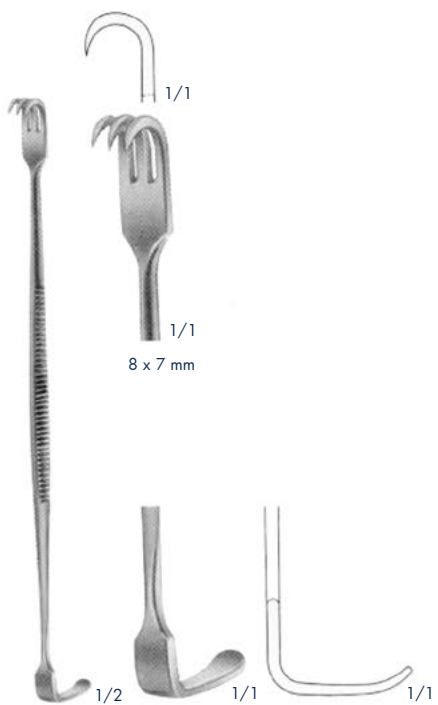

18 x 5,5 mm

SENN-MILLER
OSI150566
165 mm

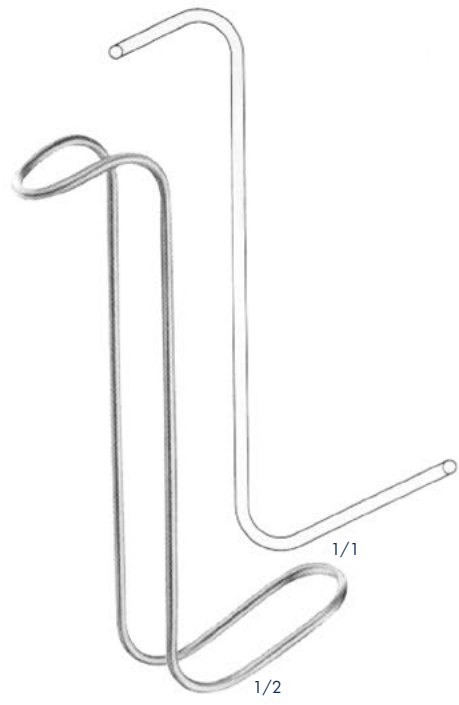

1/2

COLLIN-HARTMANN
OSI150313
150 mm

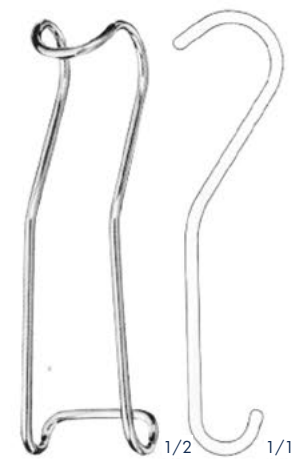

1/2

1/1

STERNBERG
OSI150567 120 mm
OSI150568 130 mm
OSI150569 135 mm

Retractors



12 x 11 mm
LUER
OSI150317
 110 mm

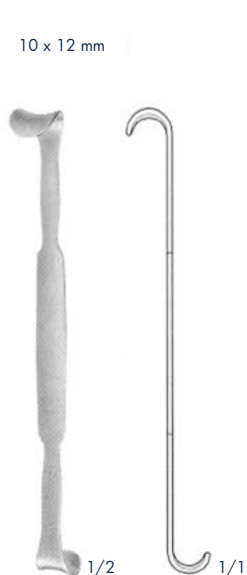

11 x 15 mm
ROSE
OSI220113
 130 mm

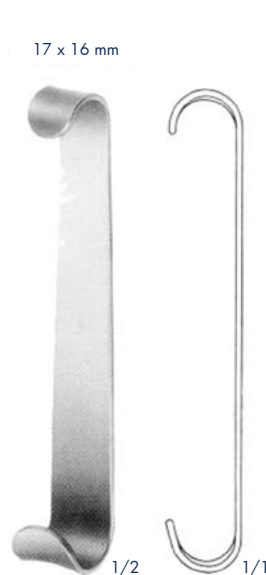

18 x 22 mm
BABY-ROUX
OSI150318
 135 mm

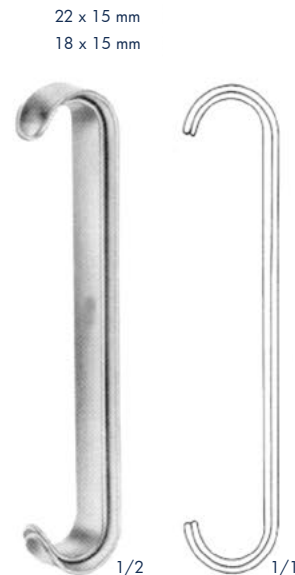

18 x 15 mm
 22 x 15 mm
PARKER
OSI150319
 135 mm



16 x 3 mm
RAGNELL
OSI150570
 150 mm

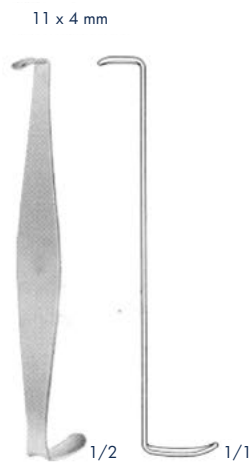

19 x 6 mm
CRILE
OSI150571
 110 mm

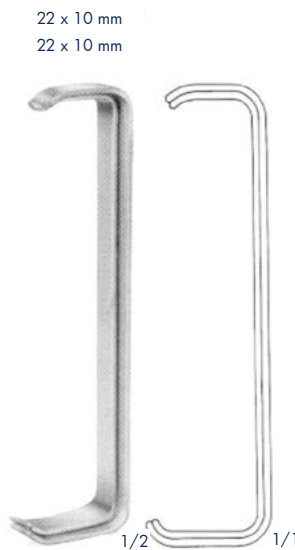

28 x 12 mm
 32 x 12 mm
FARABEUF
OSI150315
 125 mm

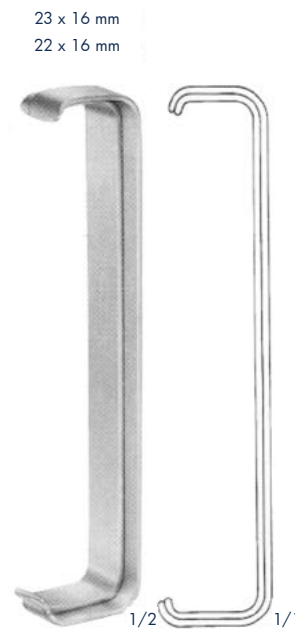

24 x 16 mm
 28 x 16 mm
FARABEUF
OSI150316
 150 mm

Retractors

21 x 14 mm
17 x 14 mm

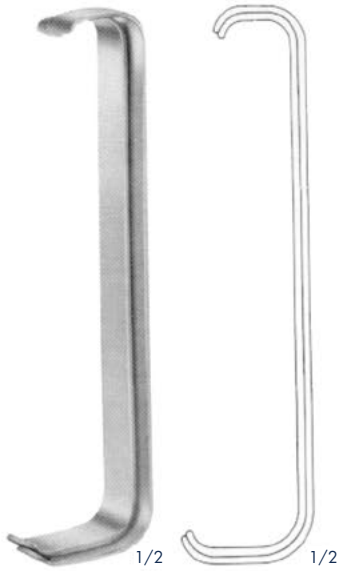

28 x 16 mm
32 x 16 mm
COLLIN
OSI150572
150 mm



ROUX
OSI150308 Set complete
165 mm
consisting of:
OSI150309
OSI150310
OSI150311

19 x 22 mm



23 x 30 mm
OSI150309

25 x 26 mm



28 x 38 mm
OSI150310

28 x 29 mm



33 x 45 mm
OSI150311

Retractors

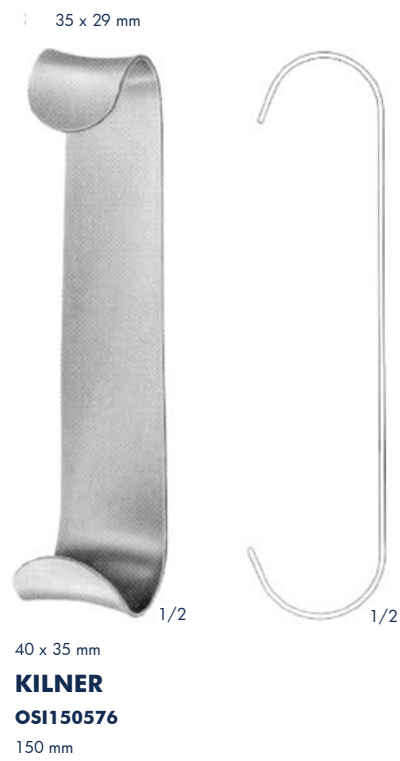
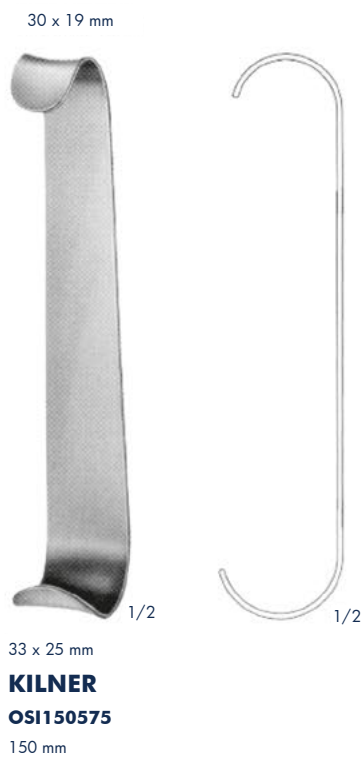
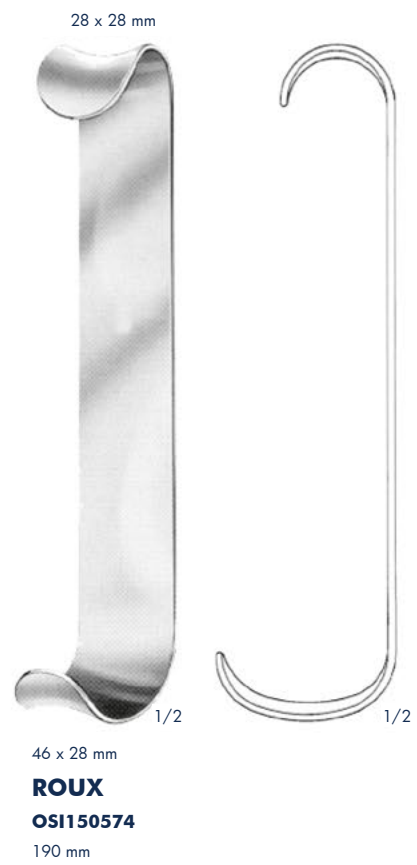
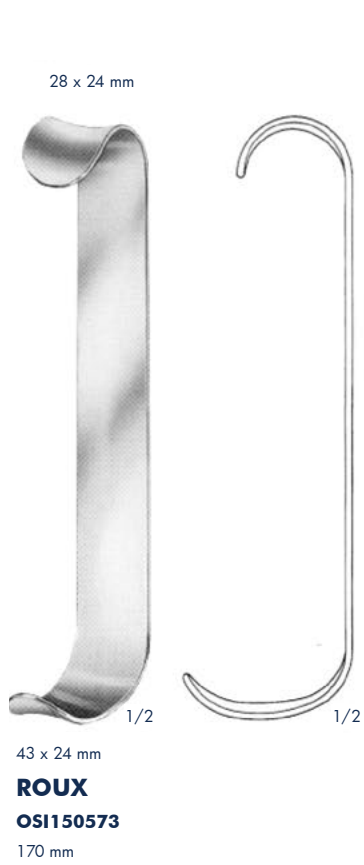

Retractors

20 x 22 mm



25 x 29 mm

ROUX
OSI150577

150 mm

25 x 26 mm

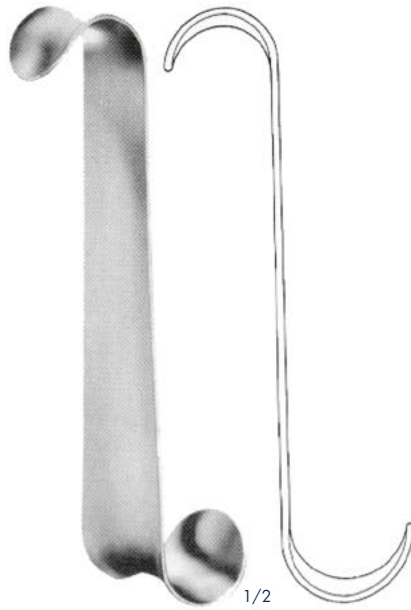

30 x 38 mm

ROUX
OSI150578

160 mm

28 x 29 mm

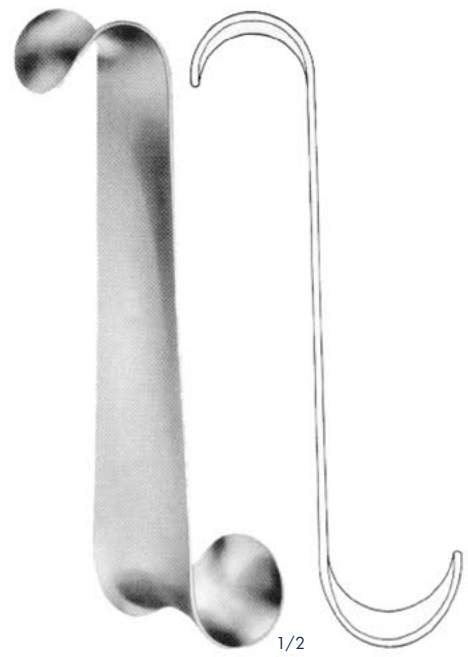

33 x 44 mm

ROUX
OSI150579

170 mm

Retractors

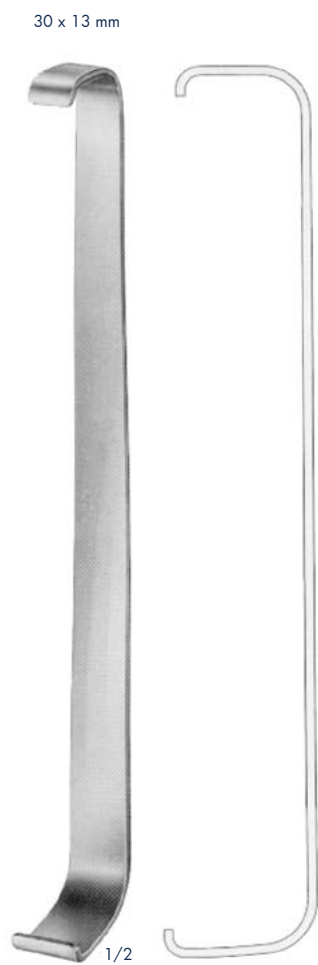

35 x 19 mm
LANE
OSI150580
230 mm

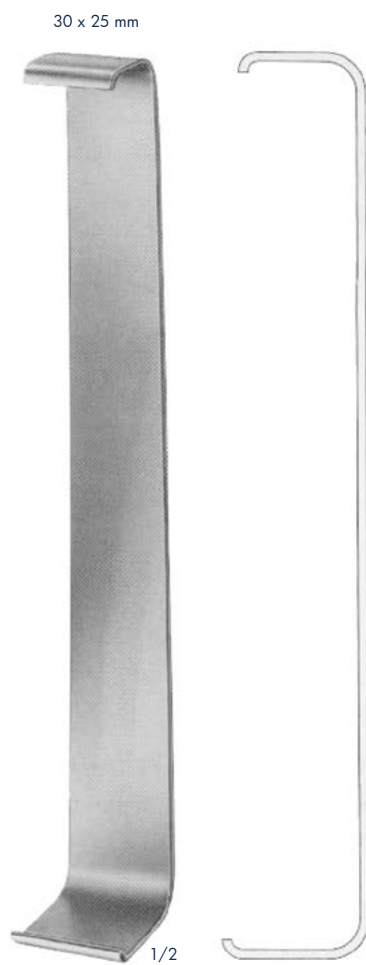

35 x 32 mm
LANE
OSI150581
230 mm

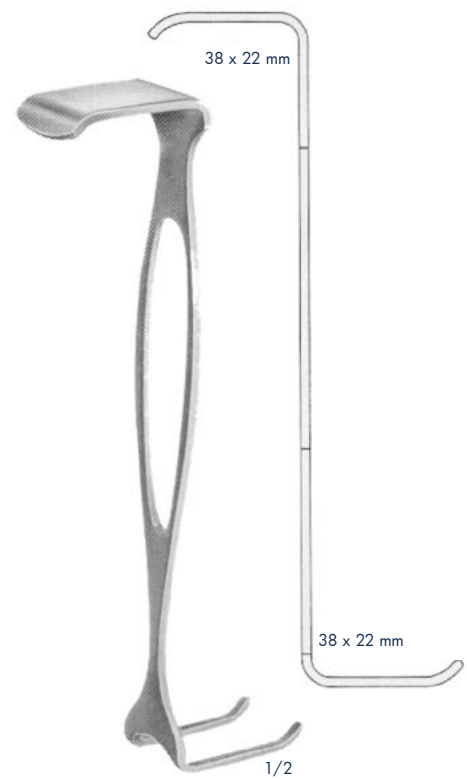

CZERNY
OSI150582
175 mm

Retractors



30 x 18 mm

25 x 10 mm

1/2

HAJEK
OSI150583
165 mm

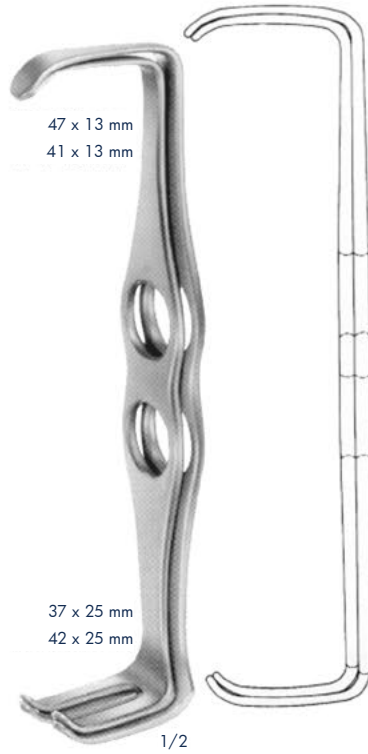

47 x 13 mm
41 x 13 mm

37 x 25 mm
42 x 25 mm

1/2

MATHIEU
OSI150320
200 mm



26 x 15 mm
22 x 15 mm

39 x 15 mm
43 x 15 mm

1/2

US-ARMY
OSI150321
220 mm

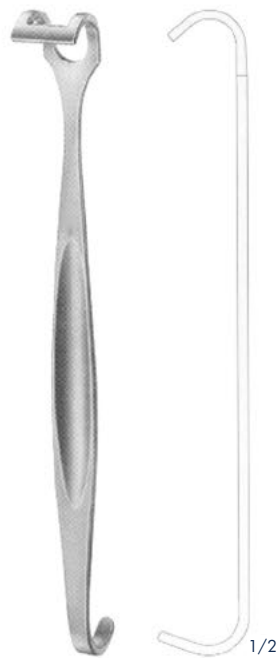

CANNY-RYALL

OSI150584 16 mm
190 mm

OSI150585 20 mm
190 mm

OSI150586 25 mm
200 mm

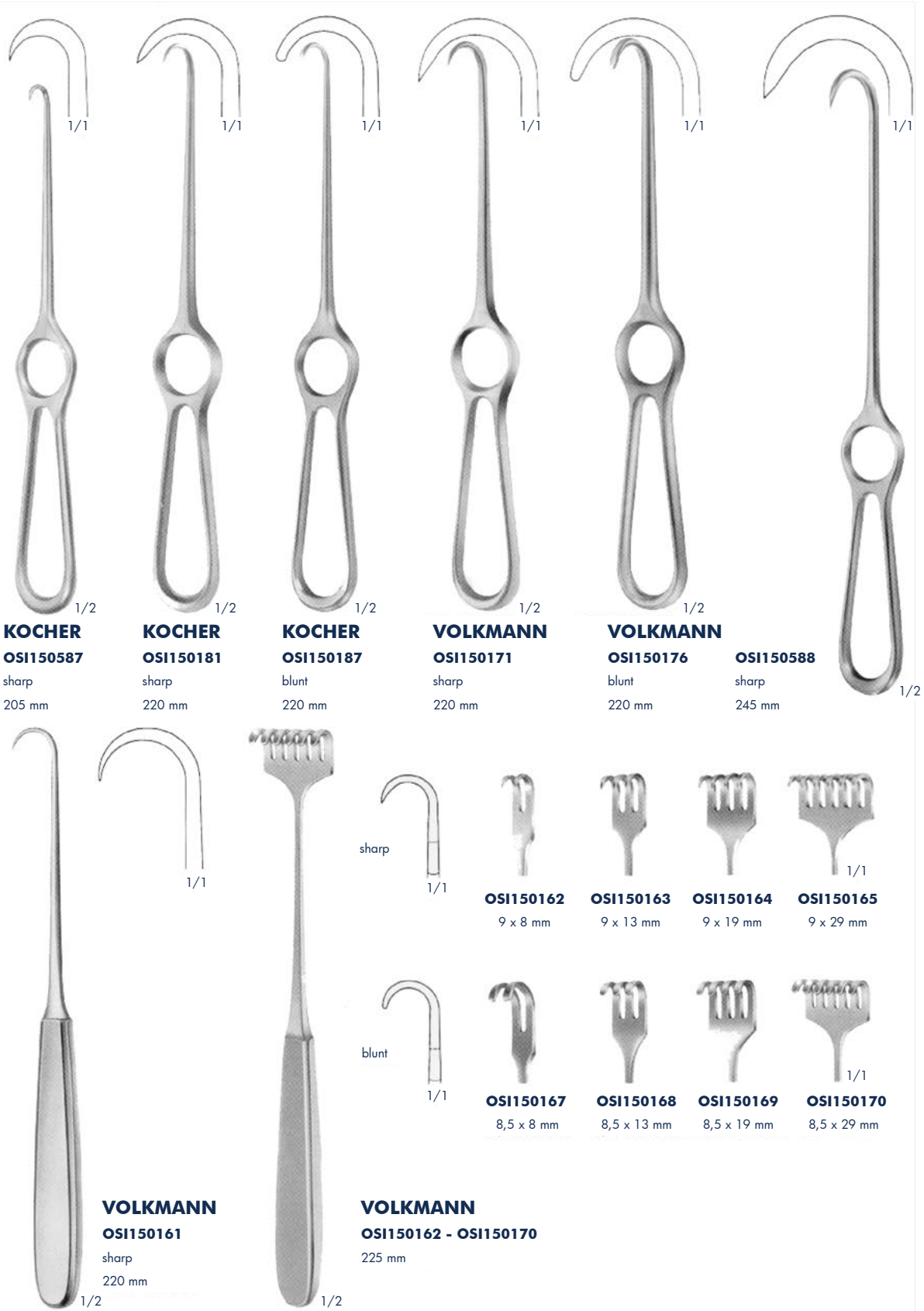

width of blade

Bone Retractors and Retractors



Retractors



sharp						
	1/1	OSI150172 9 x 8 mm	OSI150173 9 x 13 mm	OSI150174 9 x 19 mm	OSI150589 9 x 29 mm	OSI150186 9 x 40 mm 1/1
blunt						
	1/1	OSI150177 8 x 8 mm	OSI150178 8 x 13 mm	OSI150179 8 x 19 mm	OSI150180 8 x 29 mm	OSI150192 8 x 40 mm 1/1
semi-sharp						
	1/1	OSI150590 8,5 x 8 mm	OSI150591 8,5 x 13 mm	OSI150592 8,5 x 19 mm	OSI150593 8,5 x 29 mm 1/1	OSI150594 8,5 x 40 mm 1/1

VOLKMANN
OSI150172 - OSI150594
220 mm



semi-sharp					
	1/1	OSI150182 16 x 9 mm	OSI150183 16 x 14 mm	OSI150184 16 x 20 mm	OSI150185 16 x 30 mm
blunt					
	1/1	OSI150188 15,5 x 9 mm	OSI150189 15,5 x 14 mm	OSI150190 15,5 x 20 mm	OSI150191 15,5 x 30 mm 1/1

KOCHER
OSI150182 - OSI150191
220 mm

Retractors, deep form

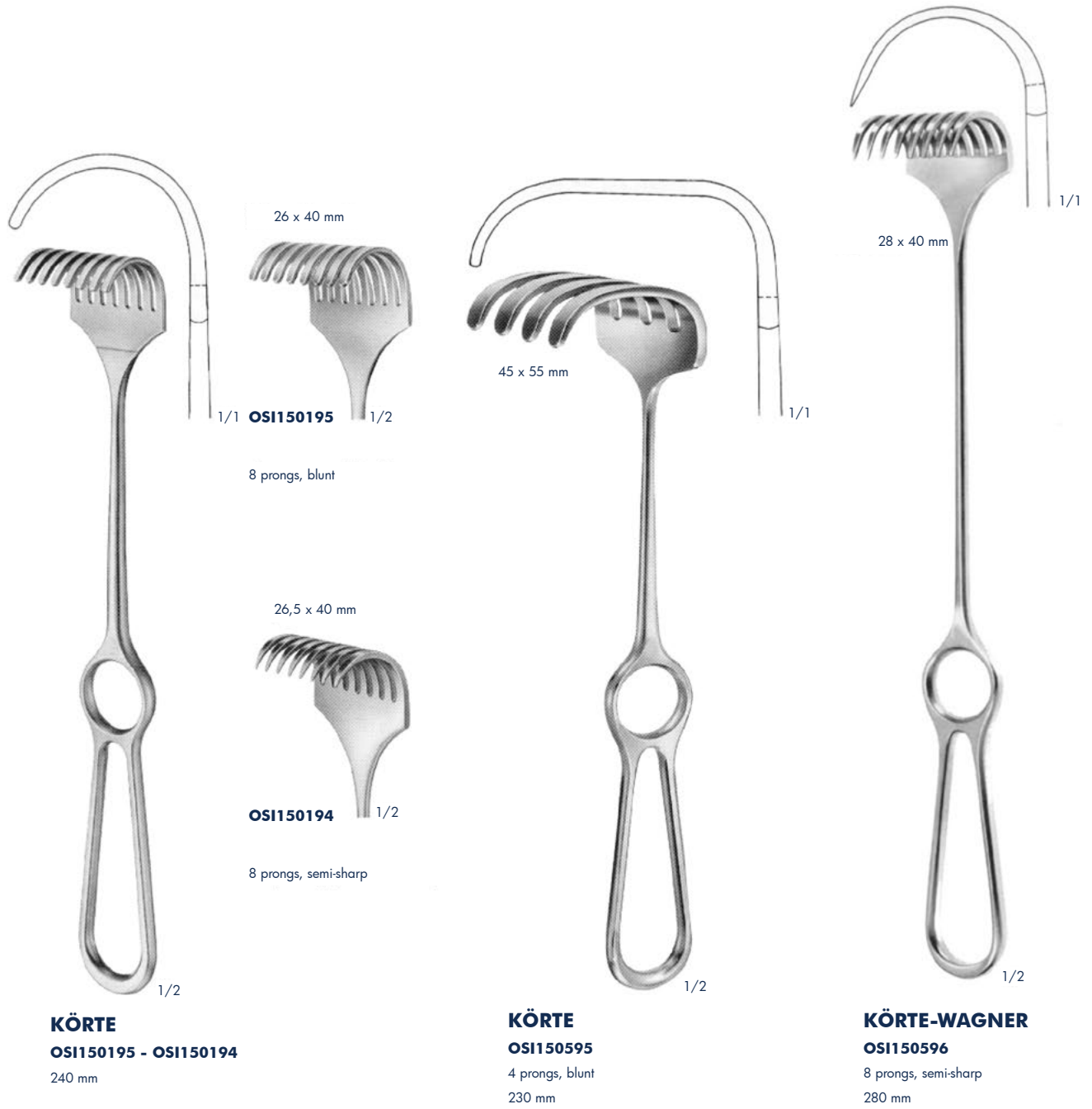

Handle vertical to the blade

Handle vertical to the blade

Retractors, deep form

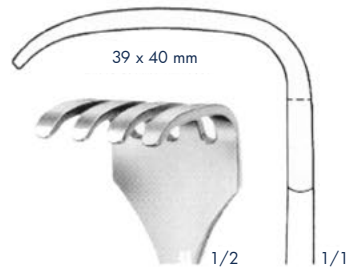

OSI150196

4 prongs, blunt

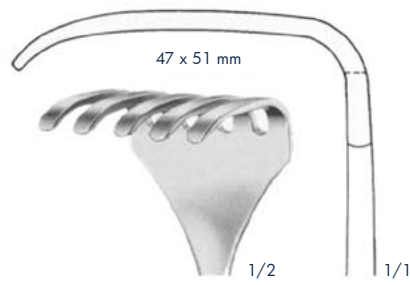

OSI150197

5 prongs, blunt

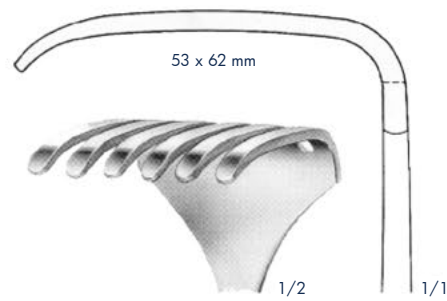

OSI150198

6 prongs, blunt

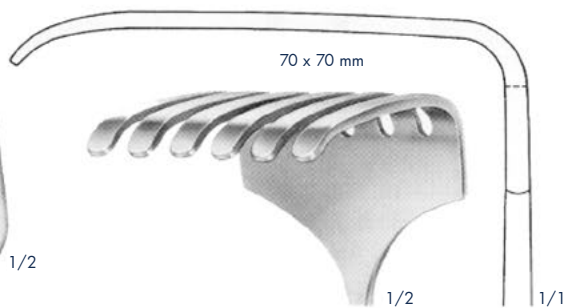

OSI150199

6 prongs, blunt



ISRAEL

OSI150196 - OSI150199

255 mm



OLLIER

OSI150193

4 prongs, blunt

230 mm

Retractors

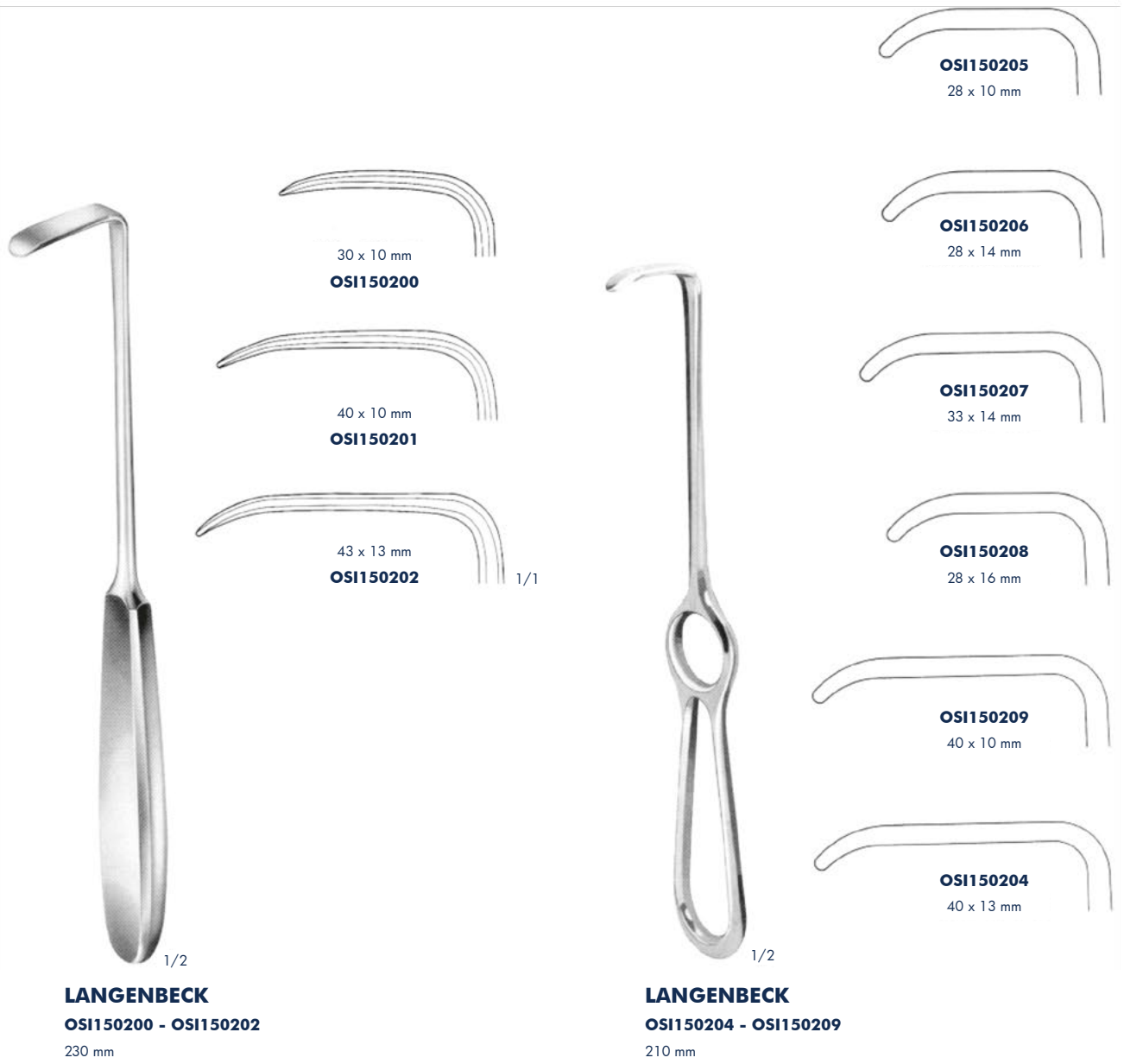

Retractors

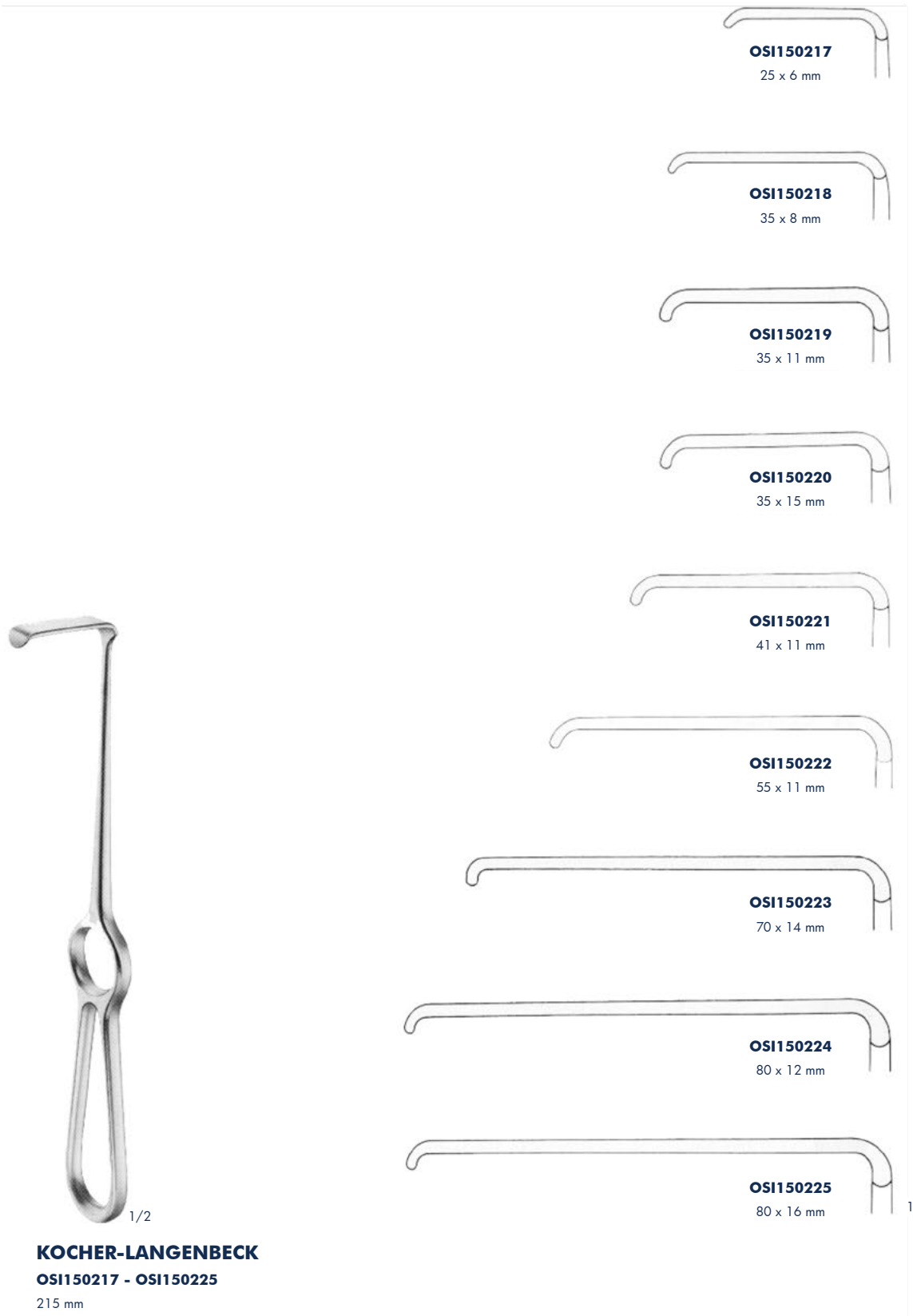

Retractors

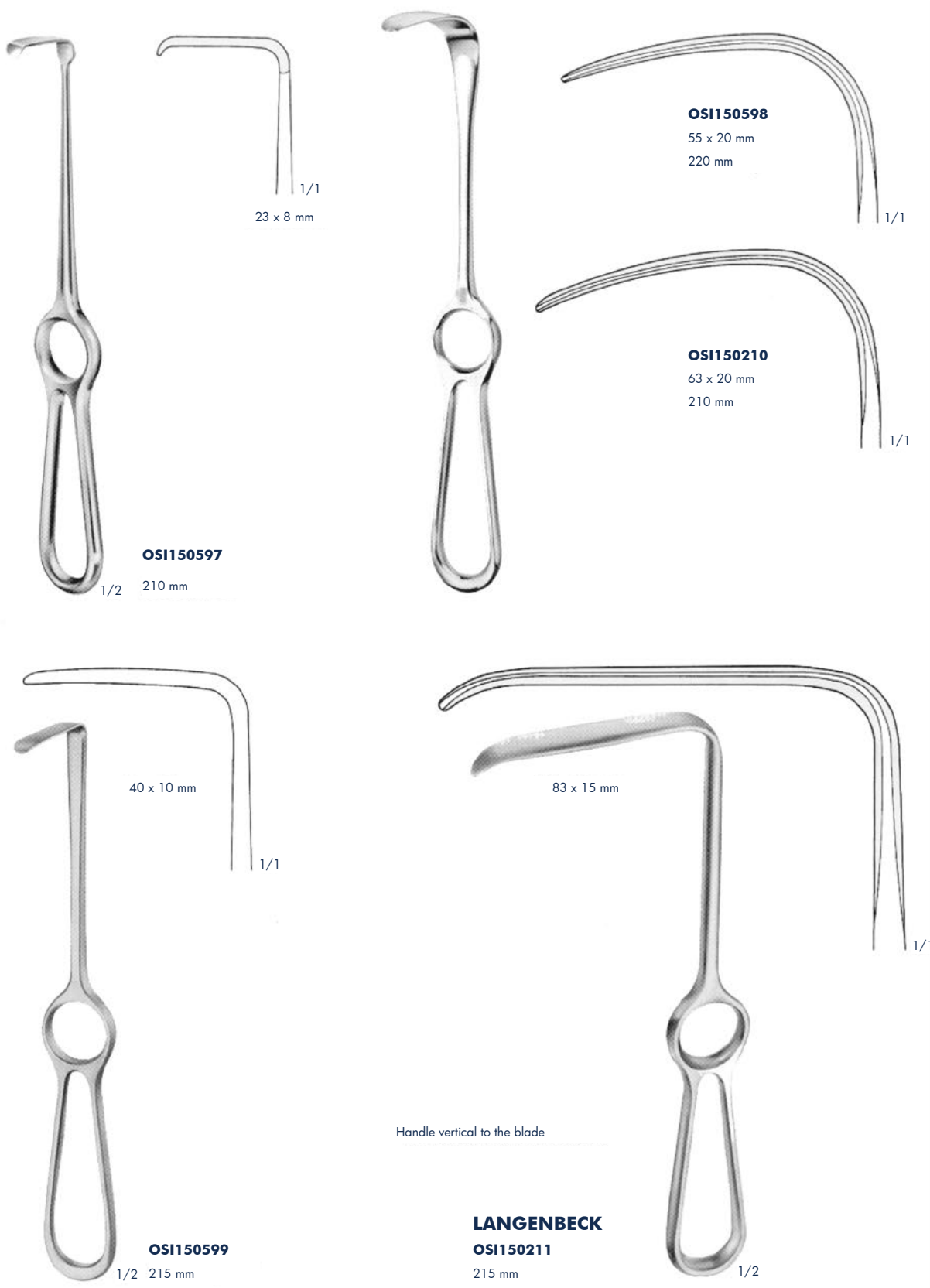

Retractors and Knee Retractors

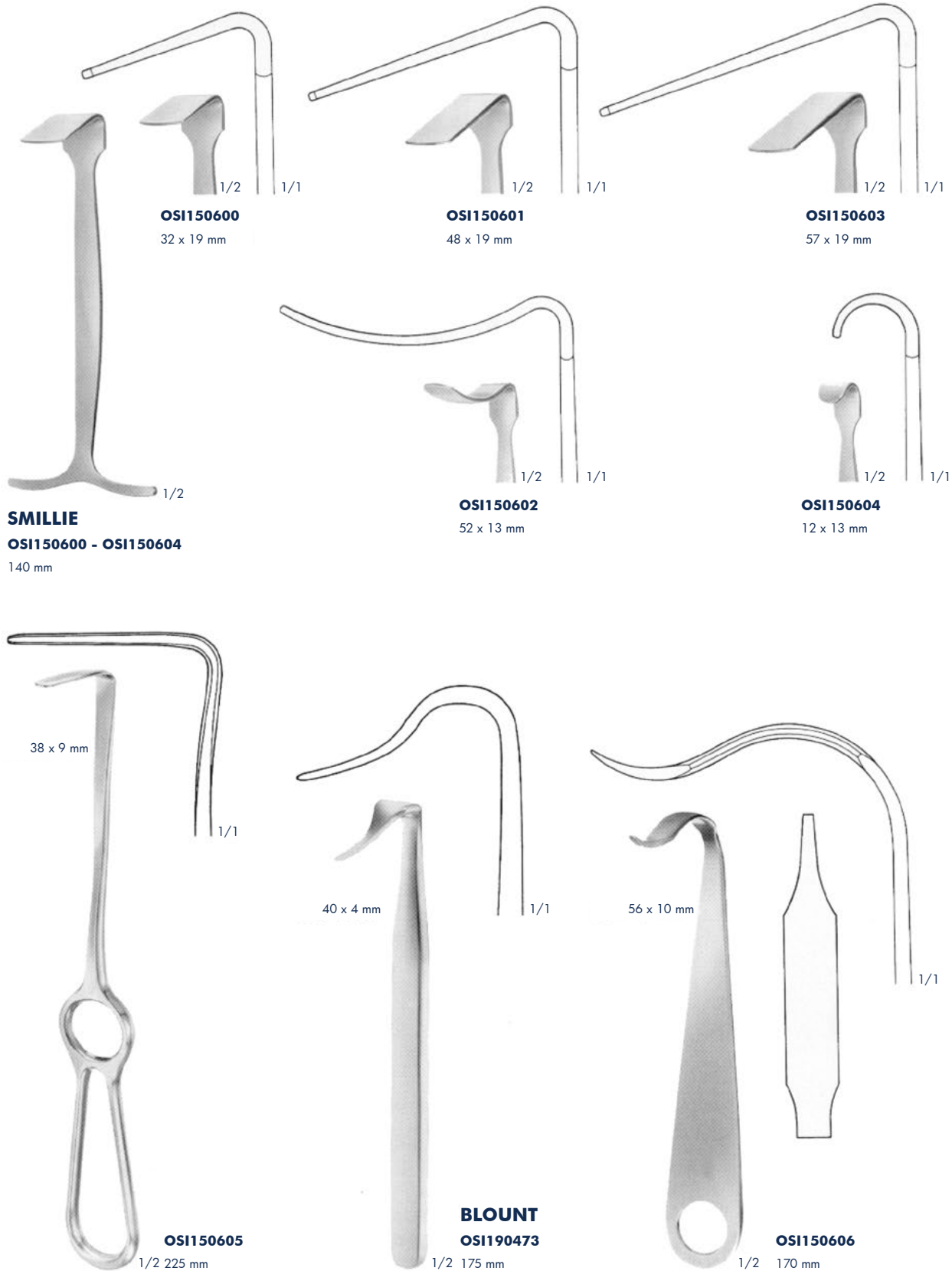

Retractors

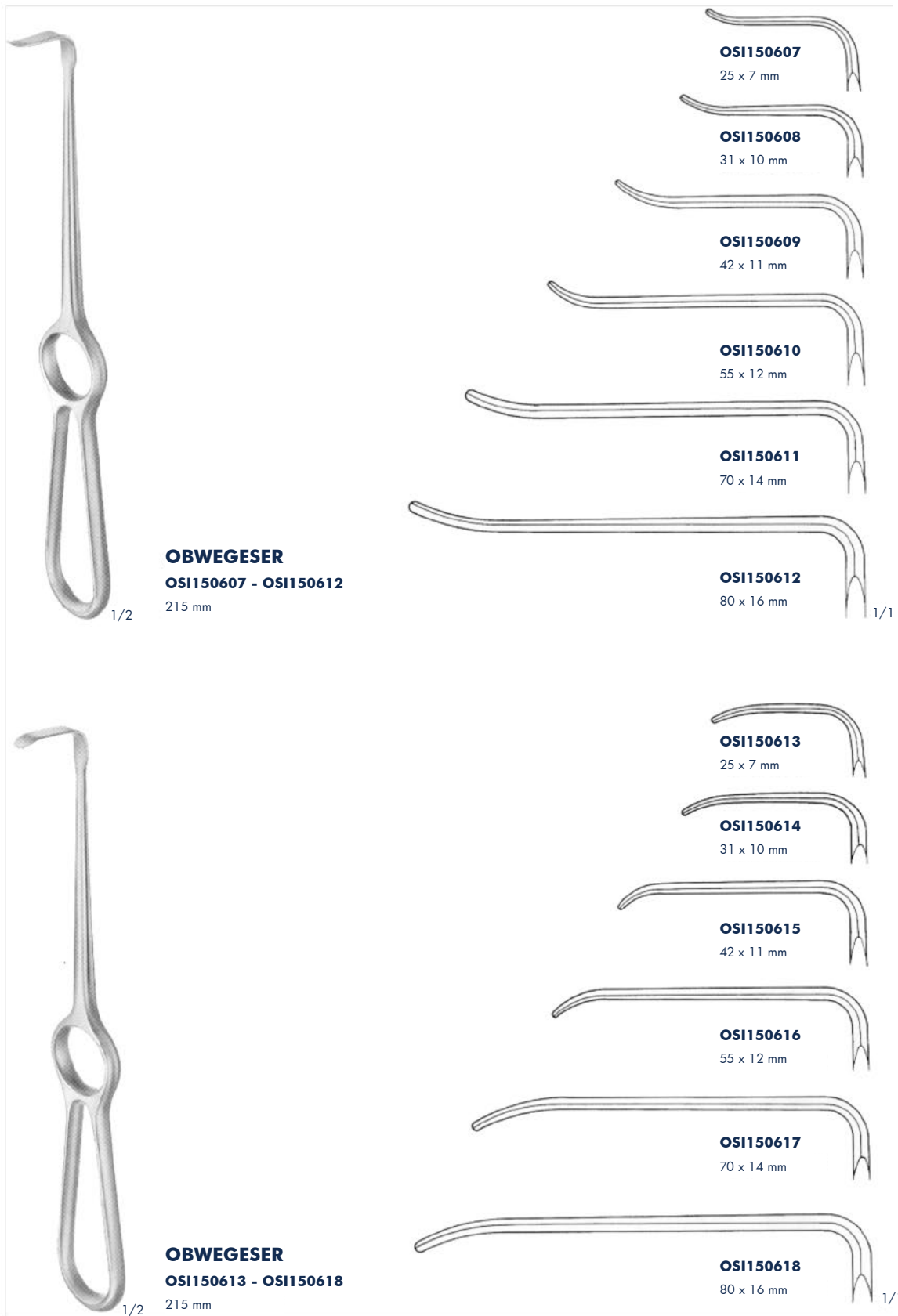

OBWEGESER
OSI150607 - OSI150612
215 mm

OBWEGESER
OSI150613 - OSI150618
215 mm

OSI150607
25 x 7 mm

OSI150608
31 x 10 mm

OSI150609
42 x 11 mm

OSI150610
55 x 12 mm

OSI150611
70 x 14 mm

OSI150612
80 x 16 mm

OSI150613
25 x 7 mm

OSI150614
31 x 10 mm

OSI150615
42 x 11 mm

OSI150616
55 x 12 mm

OSI150617
70 x 14 mm

OSI150618
80 x 16 mm

Retractors



1/2

KOCHER
OSI150212 - OSI150216
230 mm

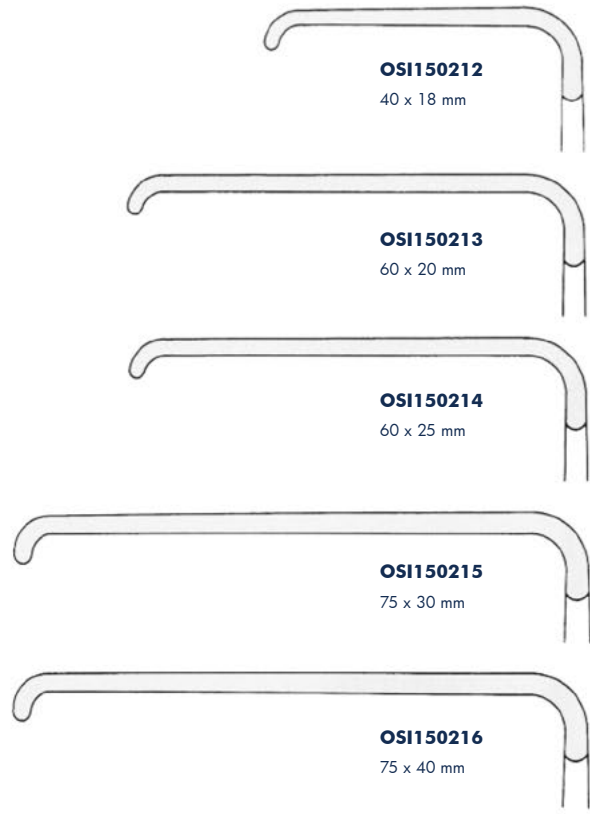

OSI150212
40 x 18 mm

OSI150213
60 x 20 mm

OSI150214
60 x 25 mm

OSI150215
75 x 30 mm

OSI150216
75 x 40 mm

1/1



1/2

SAUERBRUCH
OSI150619 - OSI150621
225 mm



OSI150619
46 x 16 mm

OSI150620
55 x 22 mm

OSI150621
72 x 19 mm

1/1

Retractors

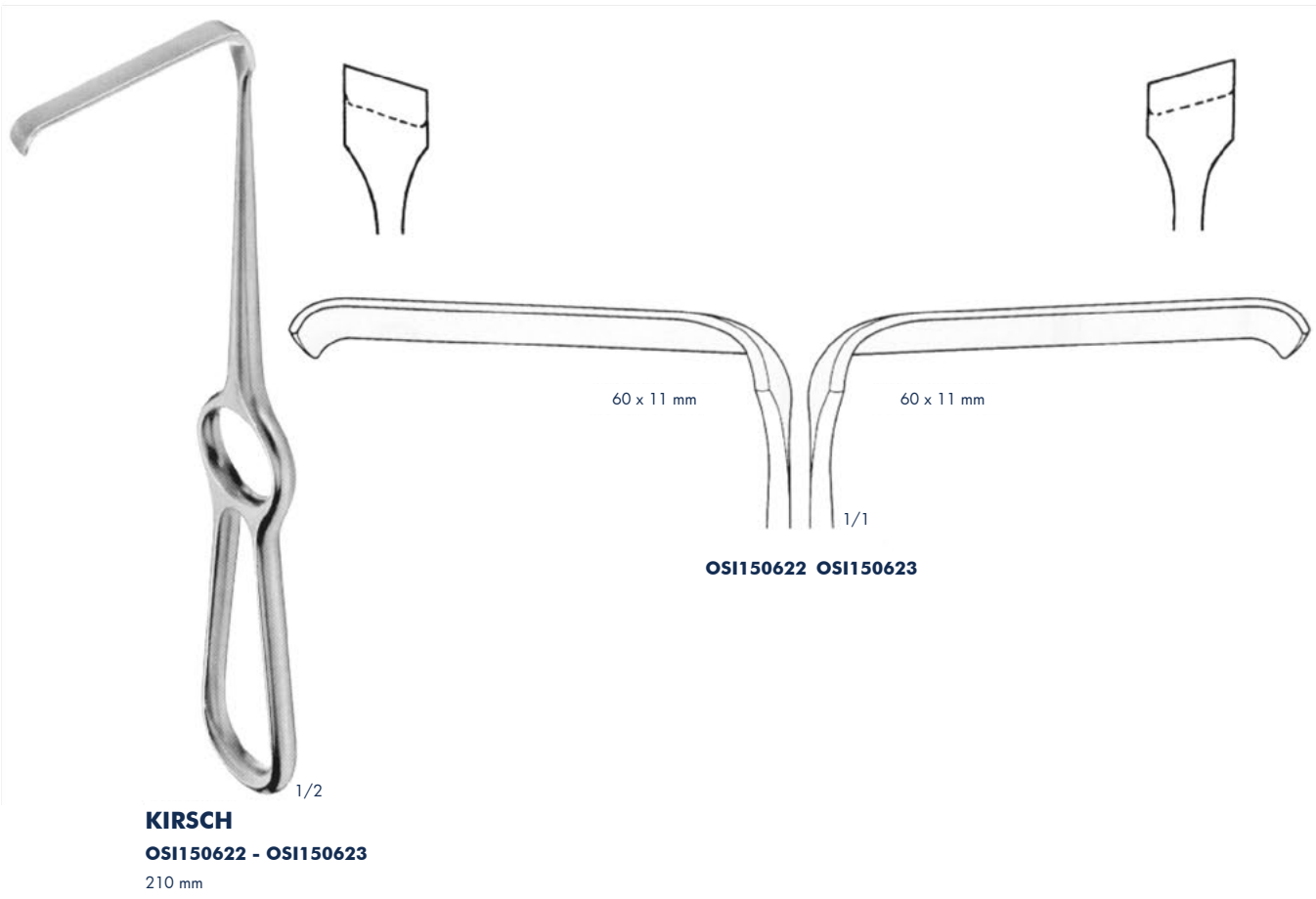

Retractors

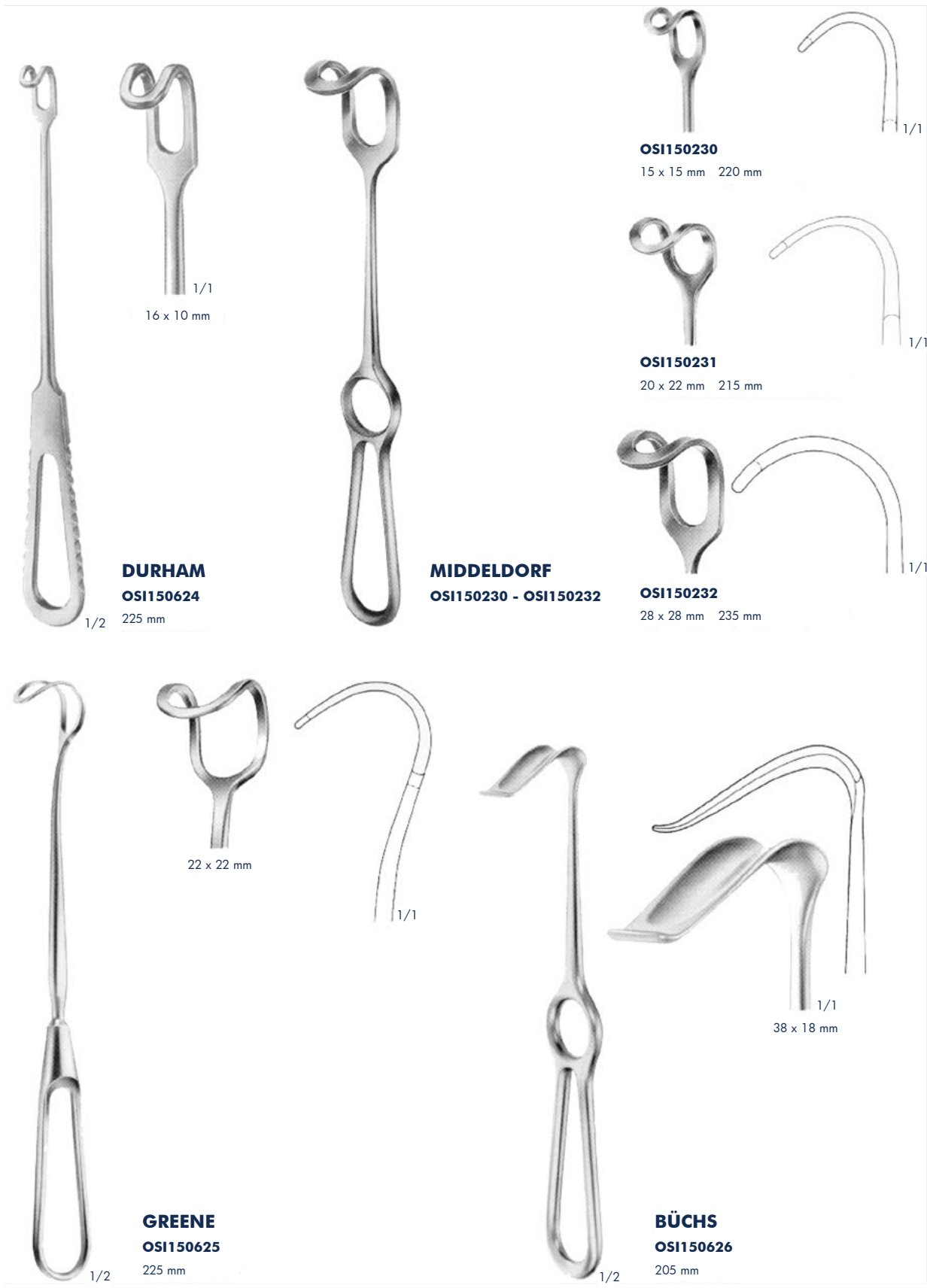

Retractors



OSI150627
205 mm

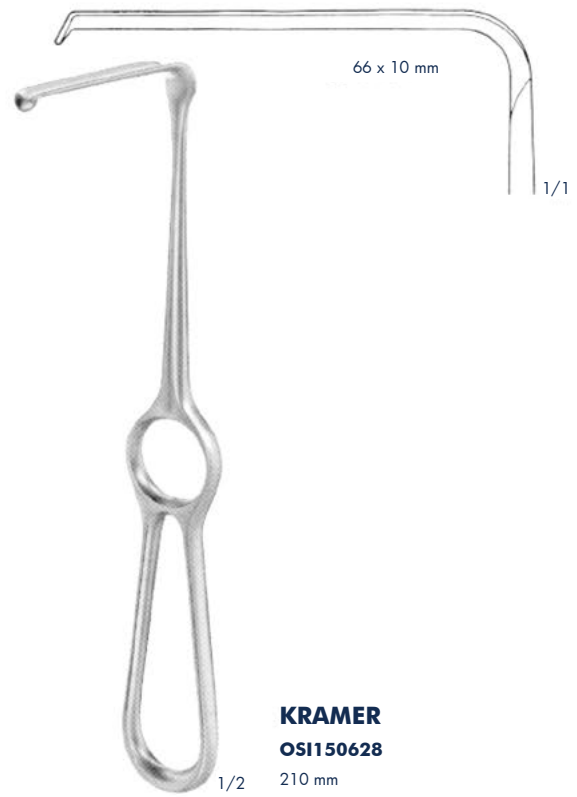

KRAMER
OSI150628
210 mm

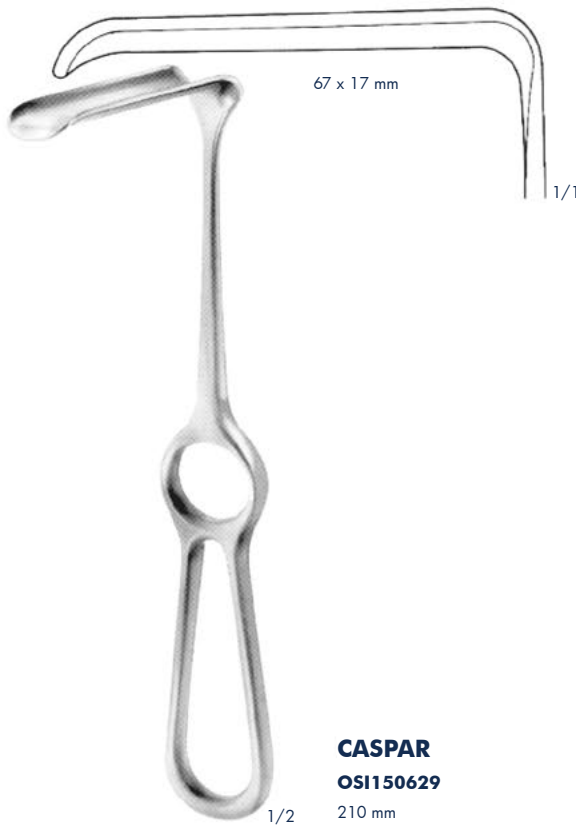

CASPAR
OSI150629
210 mm

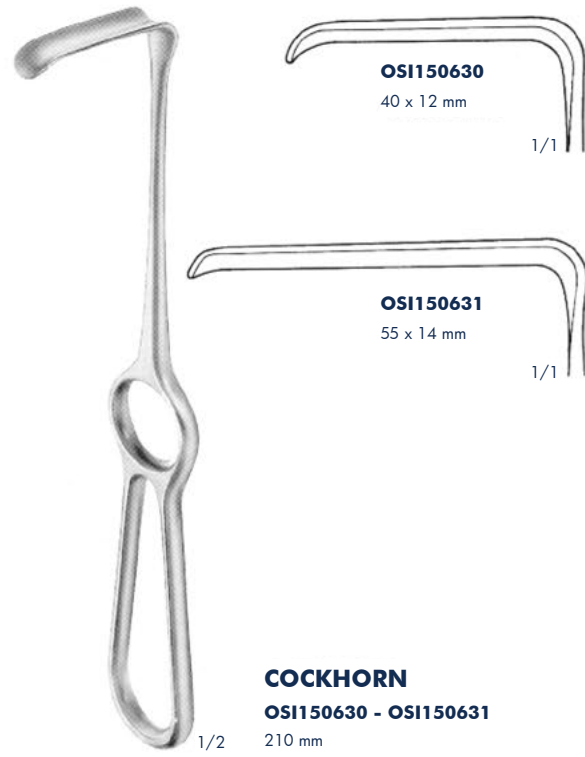

OSI150630
40 x 12 mm

OSI150631
55 x 14 mm

COCKHORN
OSI150630 - OSI150631
210 mm

Retractors

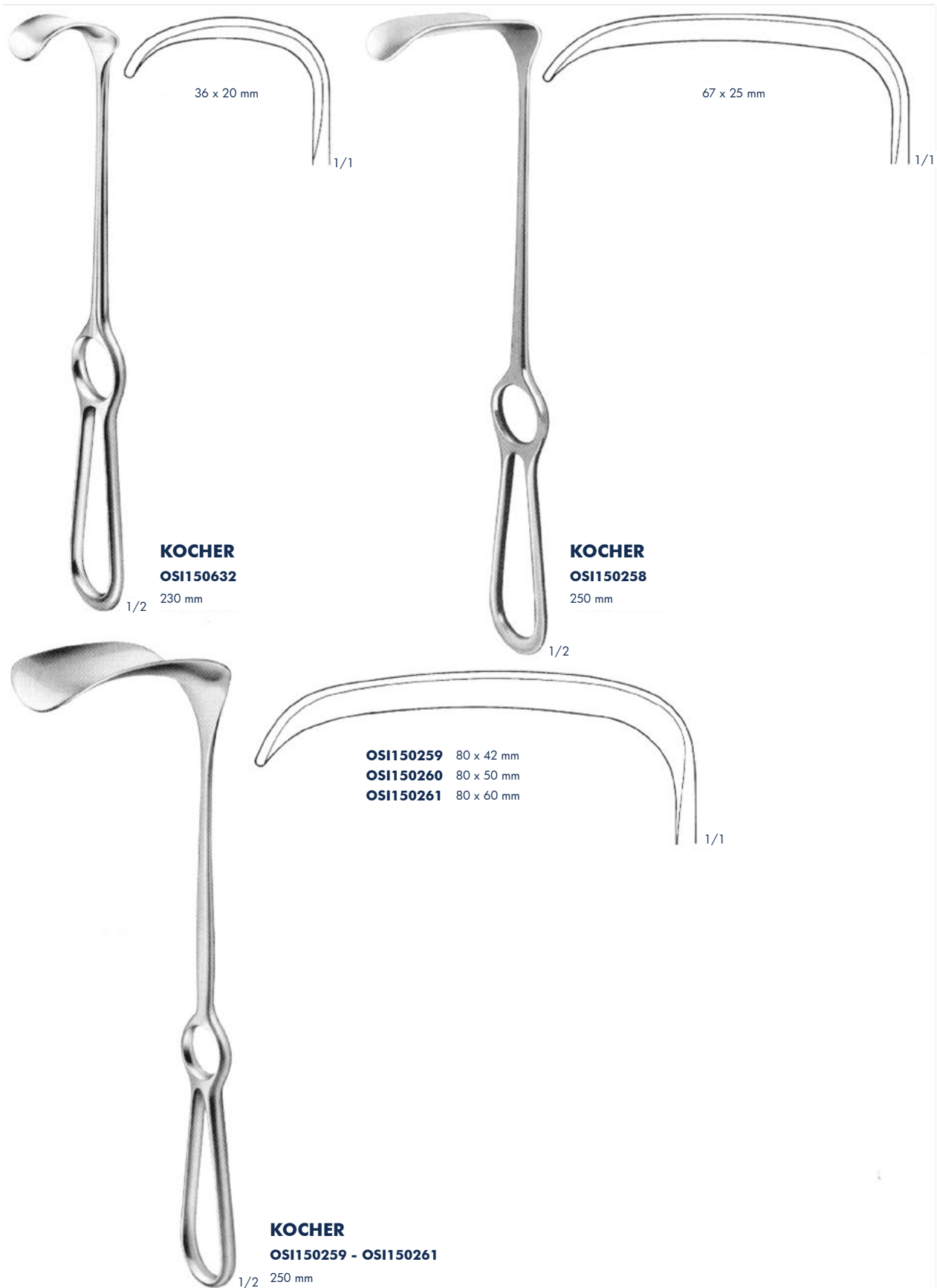

KOCHER
OSI150632
230 mm

KOCHER
OSI150258
250 mm

OSI150259 80 x 42 mm
OSI150260 80 x 50 mm
OSI150261 80 x 60 mm

KOCHER
OSI150259 - OSI150261
250 mm

TUBB
OSI180
230 mm
Set, consti
45°
Ø 4,5 mm

Retractors

S
285

isting of:

m



KOCHER-WAGNER
OSI150241 - OSI150633
280 mm

1/2

OSI150241
20 x 15 mm



1/2

1/1

OSI150242
36 x 20 mm



1/2

1/1

OSI150243
64 x 25 mm



1/2

1/1

OSI150633
94 x 36 mm



1/2

1/1

Retractors

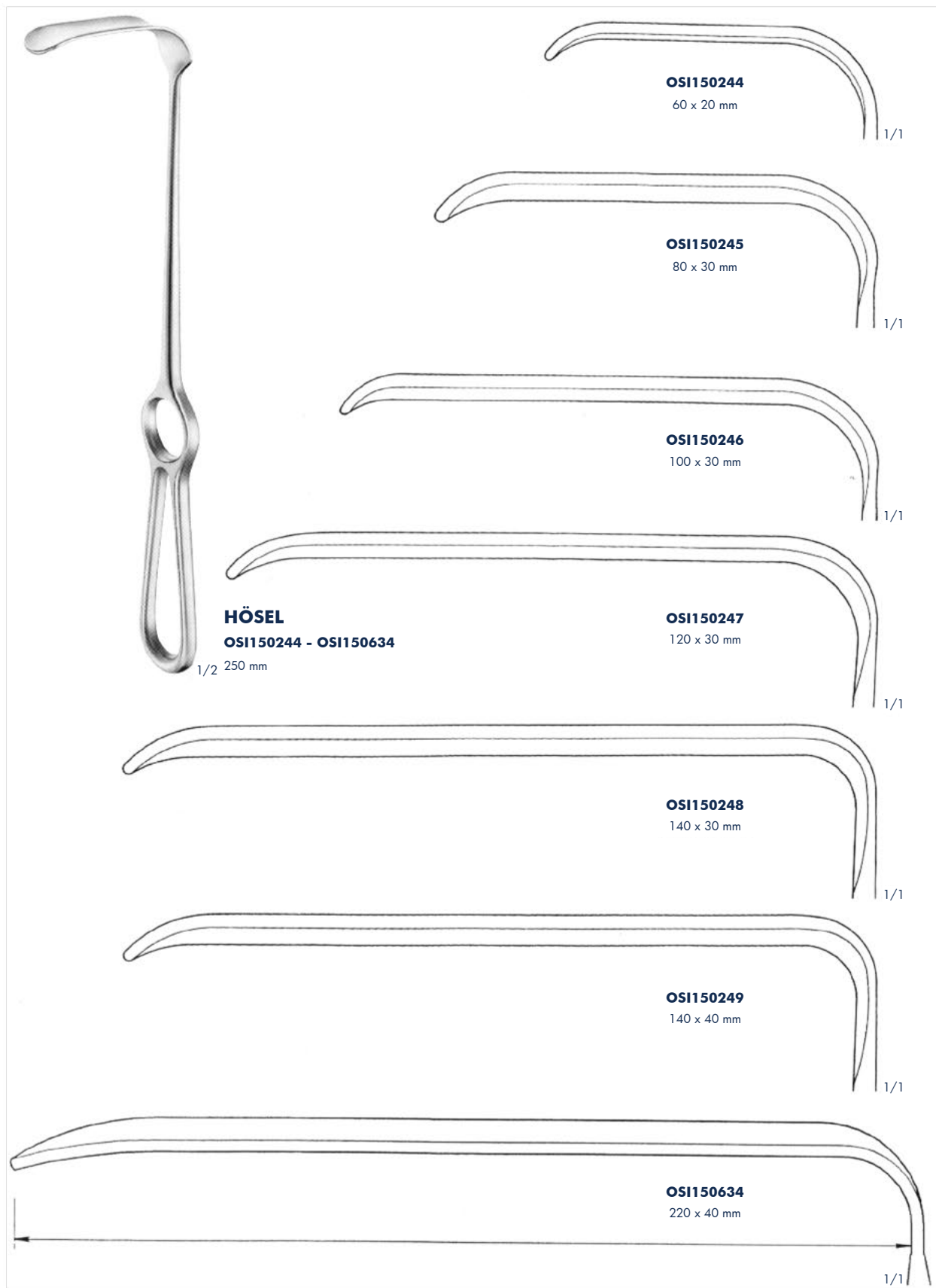

Retractors

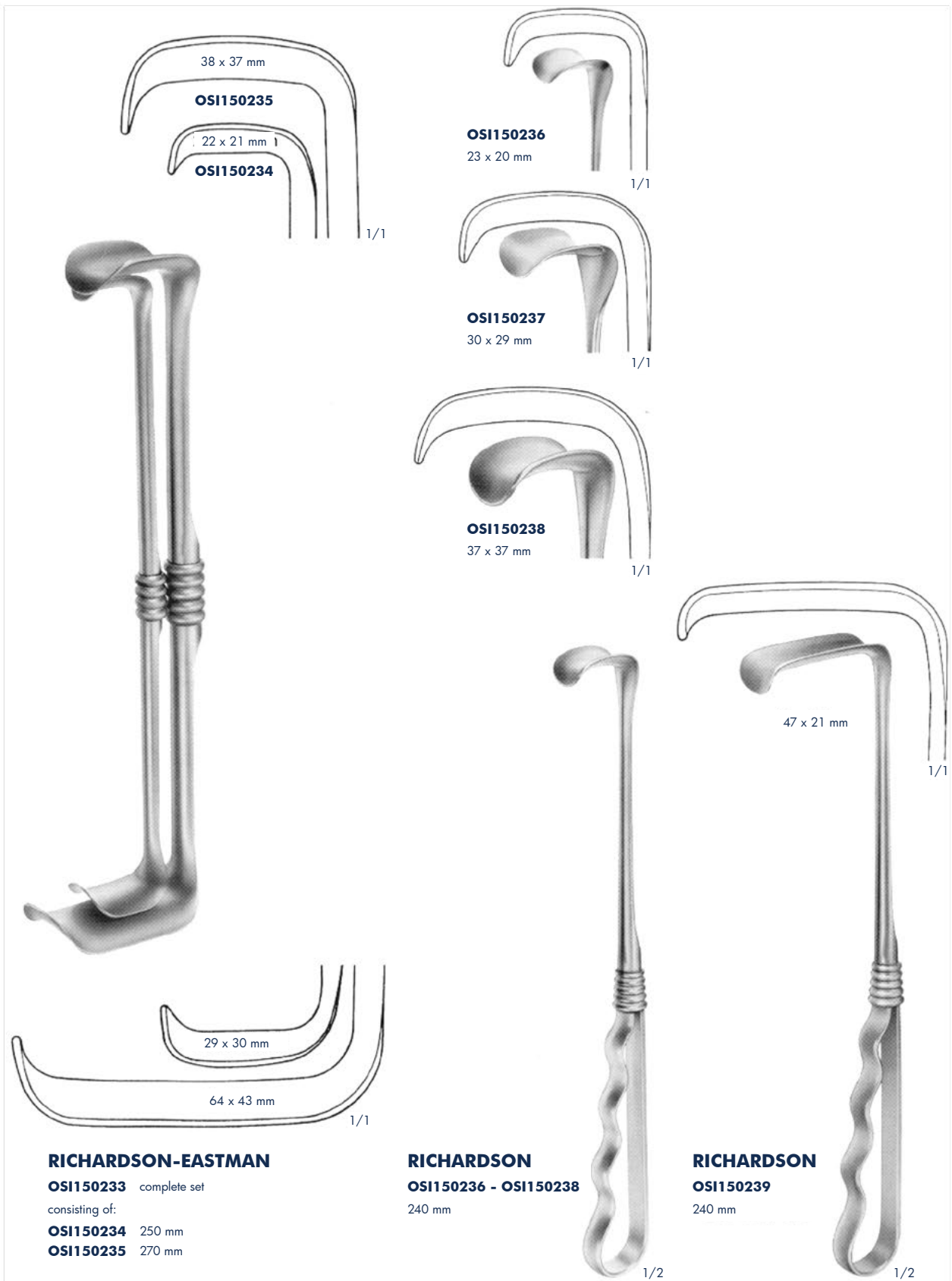

Retractors

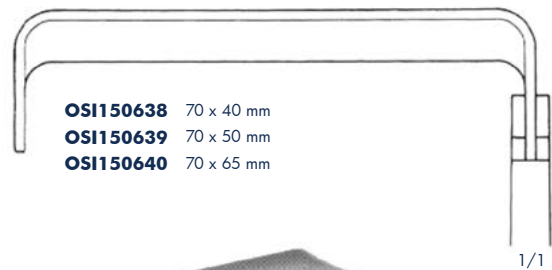
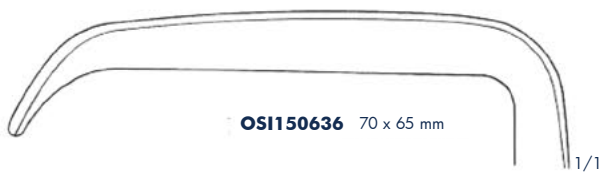
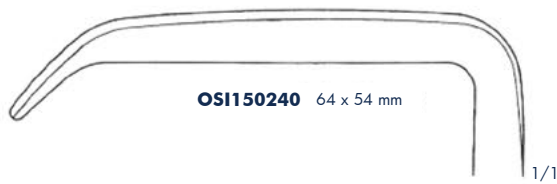

KELLY
OSI150635 - OSI150637
 260 mm

1/2

MORRIS
OSI150638 - OSI150640
 245 mm

1/2

Retractors



Retractors

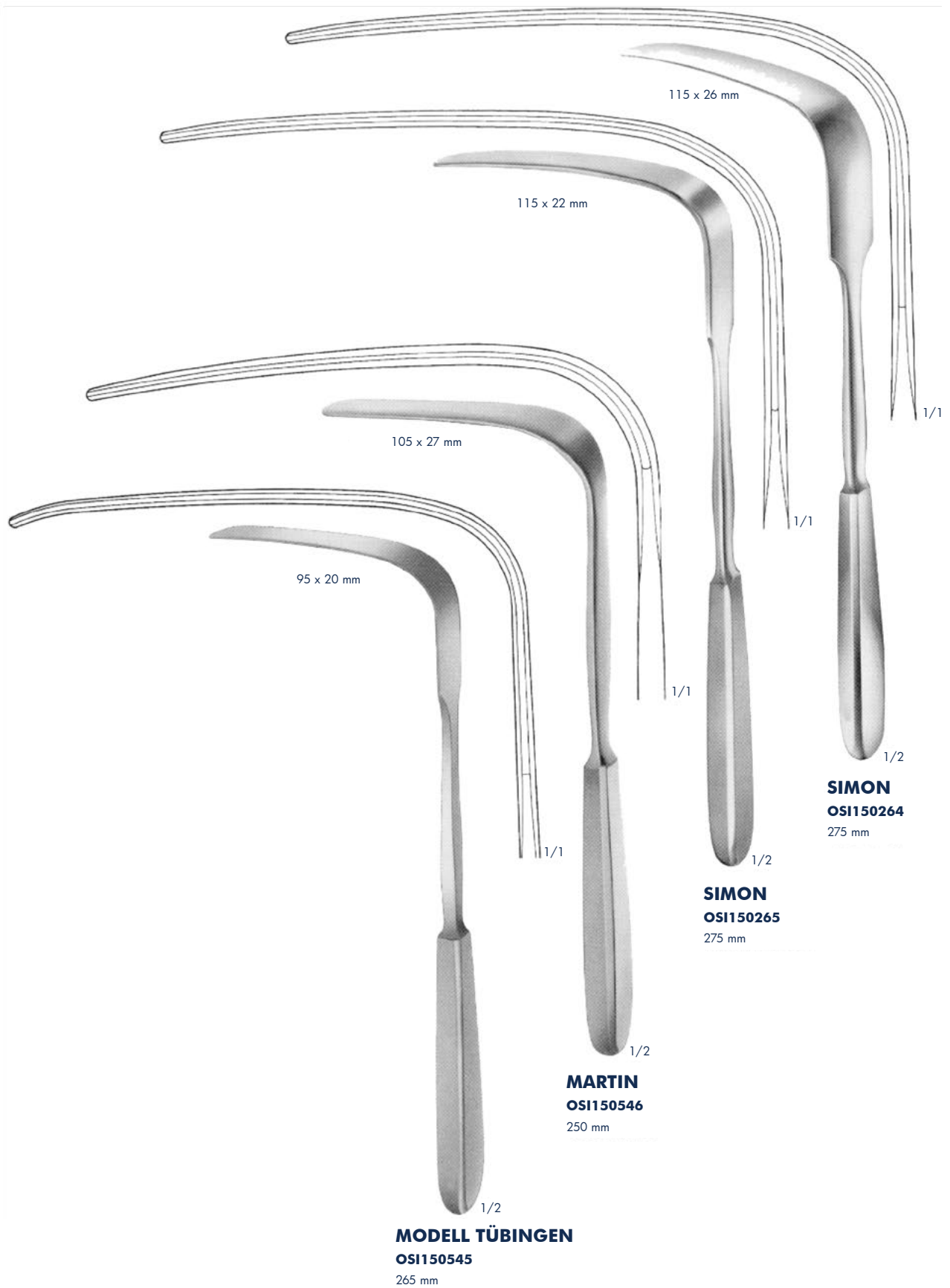

Retractors



BRUNNER
OSI150275 - OSI150280
250 mm

Retractors

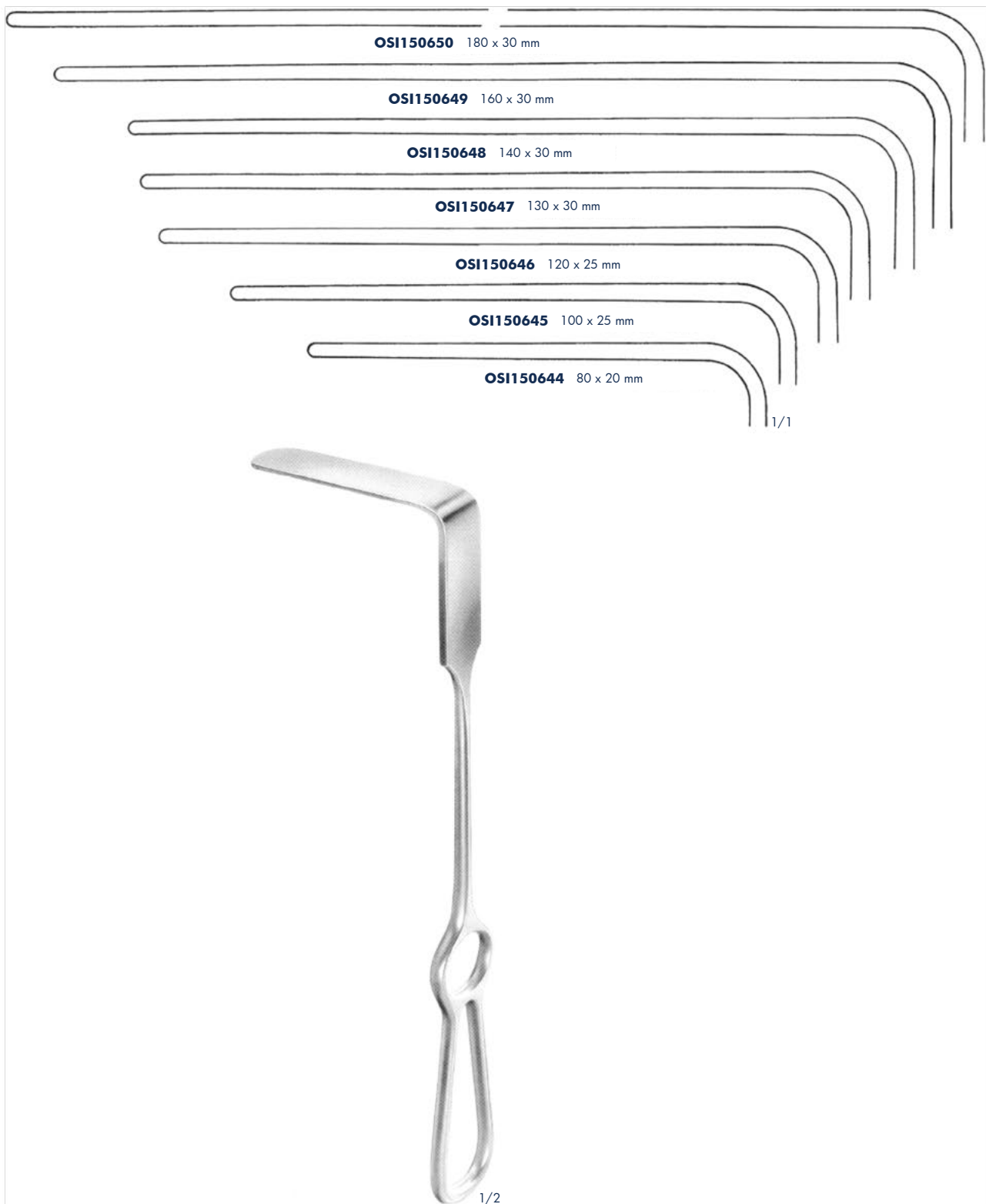

BRUNNER
OSI150644 - OSI150650
275 mm

Vario Retractors System

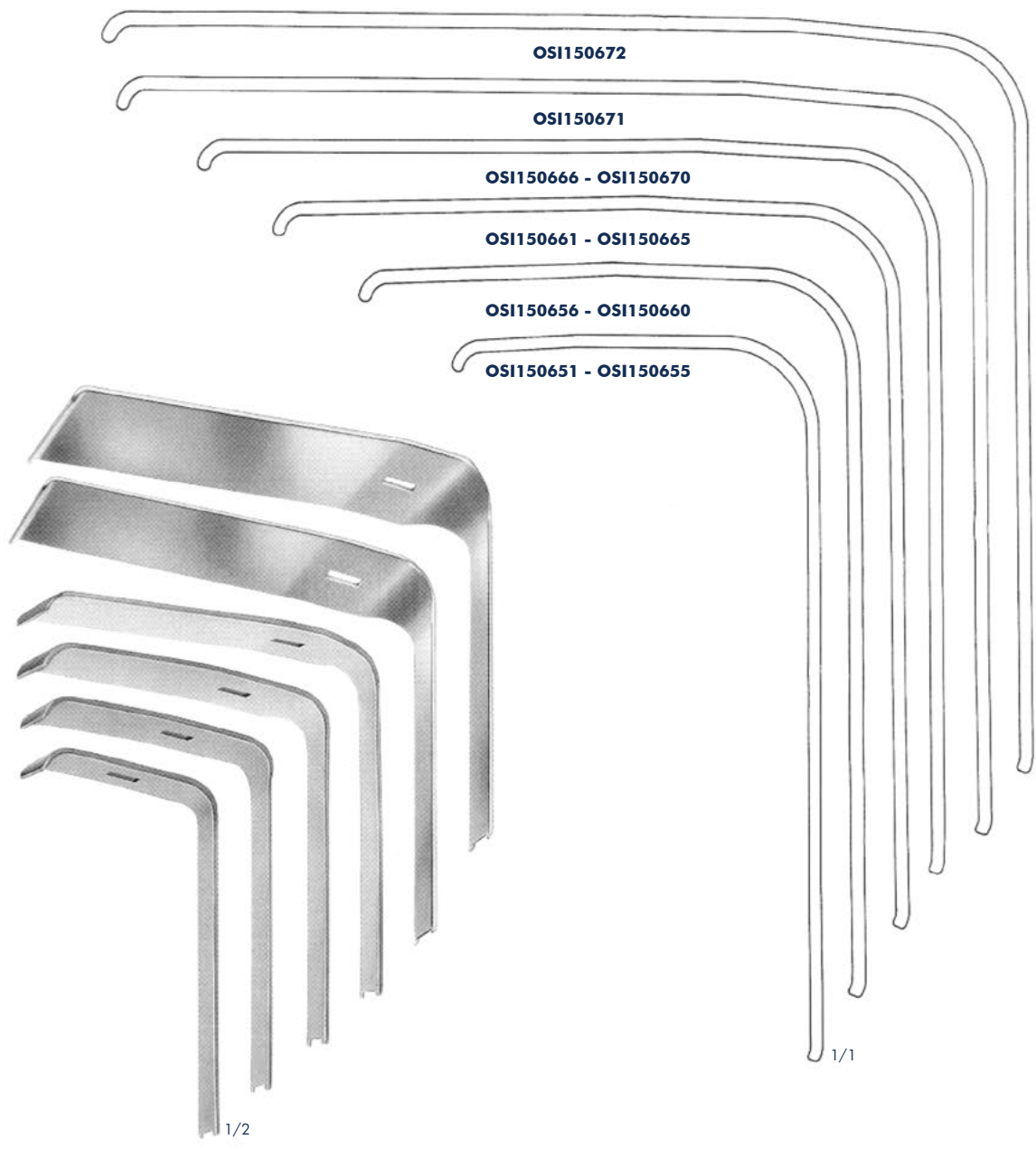

Retractor blades for handles

Depth	Width						
	14 mm	18 mm	22 mm	26 mm	30 mm	40 mm	50 mm
55 mm	OSI150651	OSI150652	OSI150653	OSI150654	OSI150655	-	-
75 mm	OSI150656	OSI150657	OSI150658	OSI150659	OSI150660	-	-
95 mm	OSI150661	OSI150662	OSI150663	OSI150664	OSI150665	-	-
115 mm	OSI150666	OSI150667	OSI150668	OSI150669	OSI150670	-	-
135 mm	-	-	-	-	-	OSI150671	-
145 mm	-	-	-	-	-	-	OSI150672

Vario Retractors System

Vario retractor system with integrated cold light, for additional intensive illumination of deep and complicated operation fields.



OS1150673
Handle with cold light carrier
for retractor blades
280 mm

OS1150674
Handle with cold light carrier
for retractor blades
180 mm

Retractors, Lung Spatulas

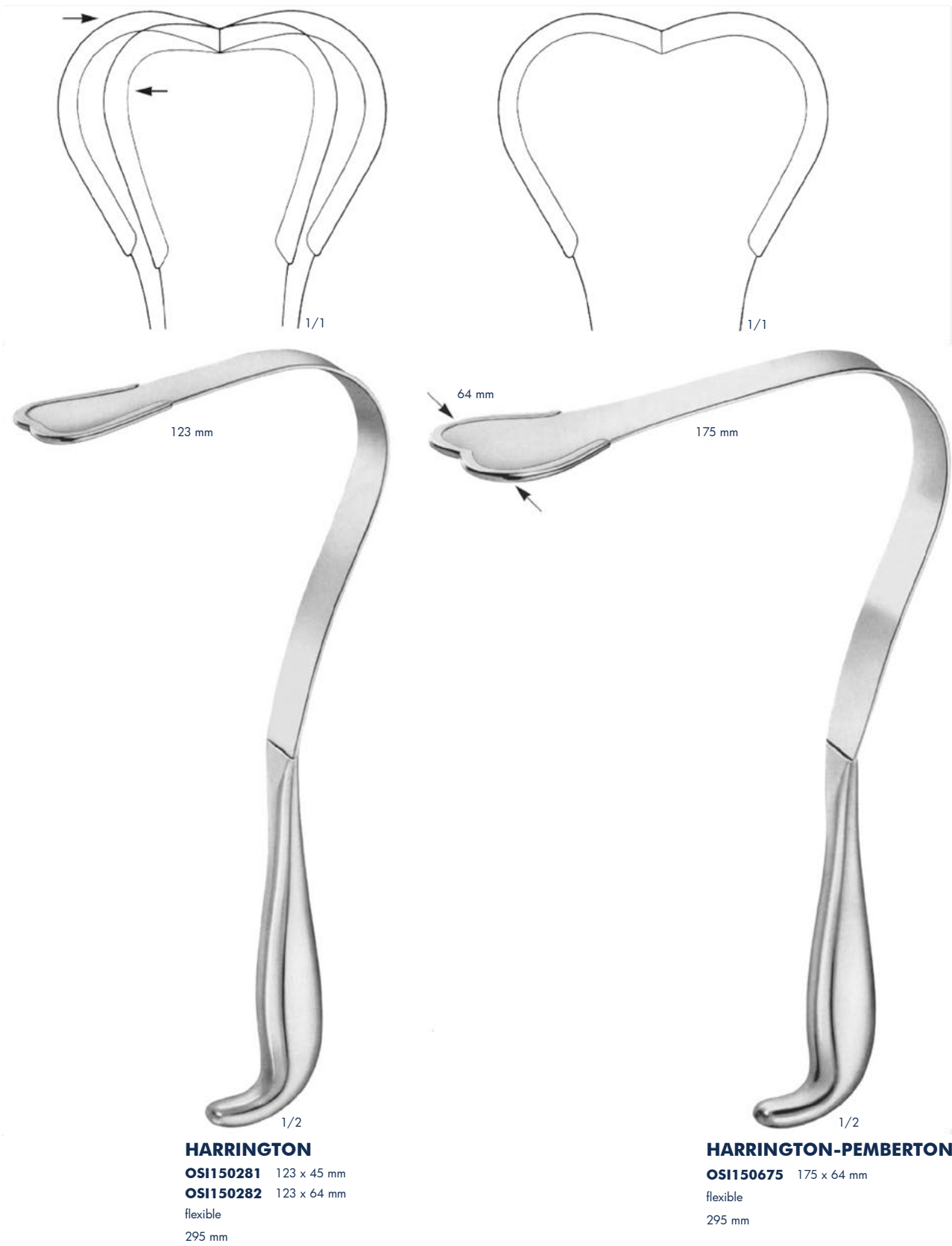

Lung Spatulas

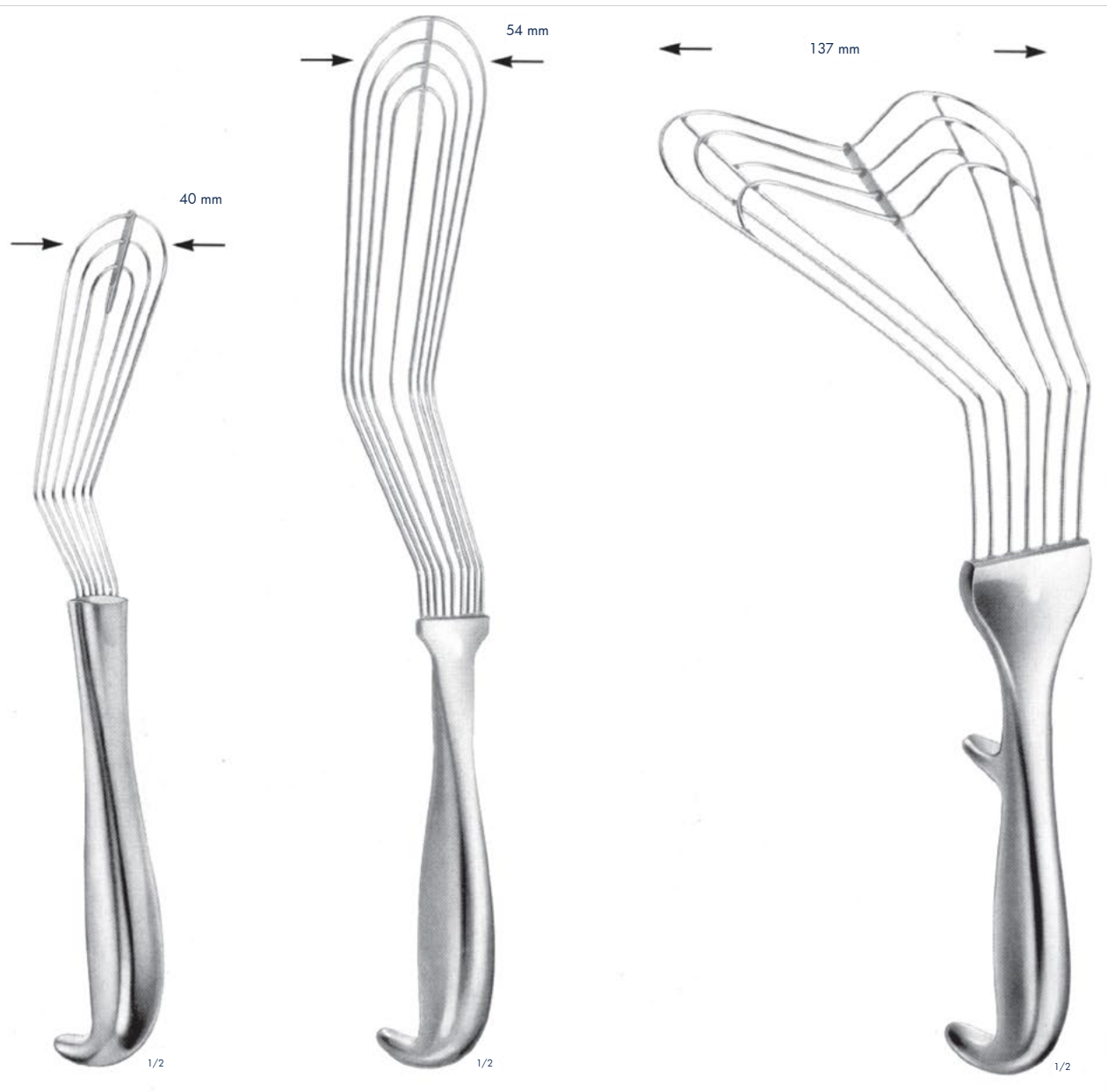

ALLISON
OSI190642
255 mm

ALLISON
OSI190643
320 mm

OSI190644
300 mm

Retractors, Lung Spatulas

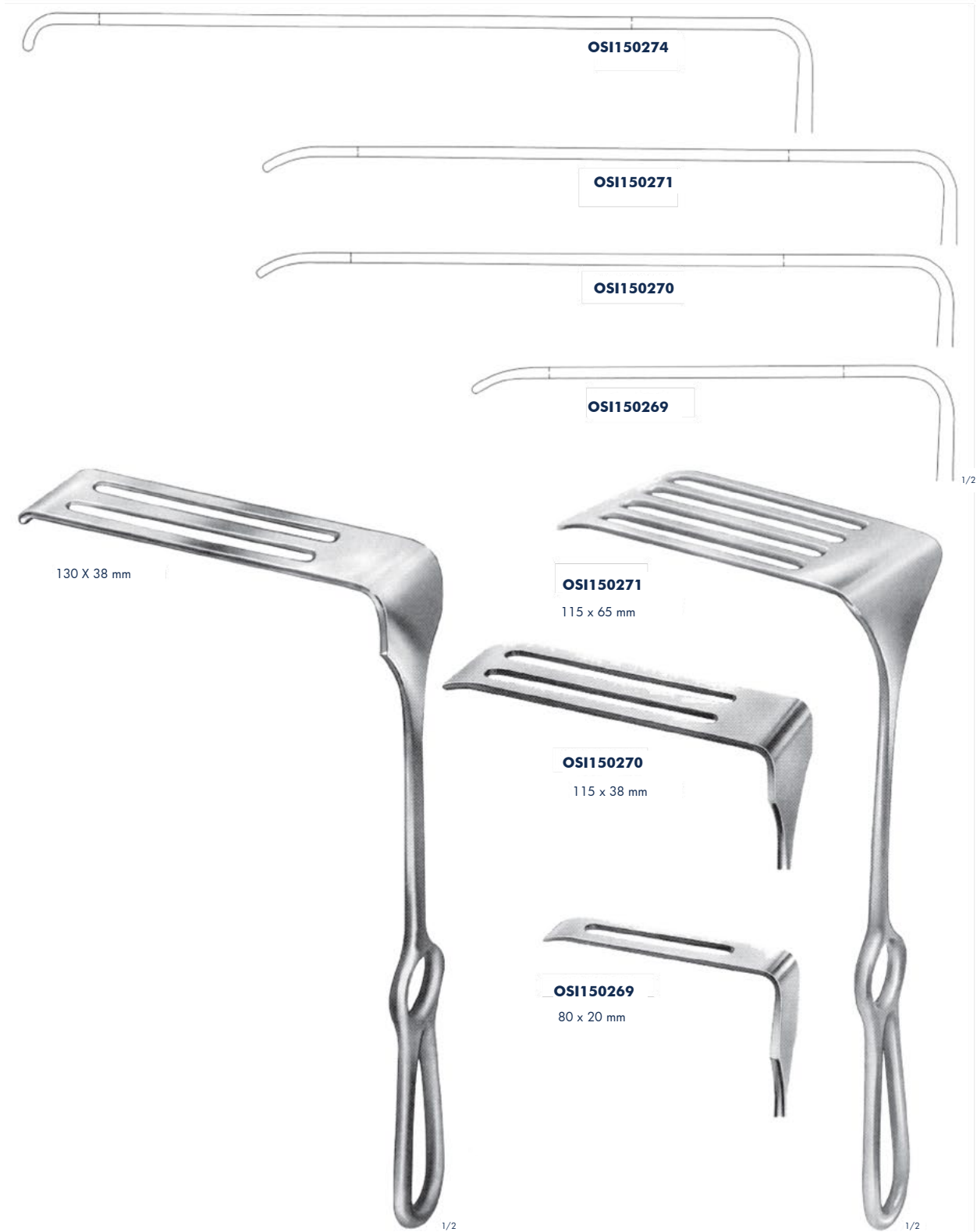

130 X 38 mm

OSI150274

OSI150271

OSI150270

OSI150269

OSI150271

115 x 65 mm

OSI150270

115 x 38 mm

OSI150269

80 x 20 mm

SAUERBRUCH

OSI150274

260 mm

CORYLLOS

OSI150269-OSI150271

255 mm

Retractors, Lung Spatulas



205 X 29 mm

1/1

1/2

OSI150676

260 mm

74 mm

92 mm

DAVIDSON

OSI150273

Scapula retractor

195 mm

Retractors



Retractors



DEAVER
OS1150283 19 mm
180 mm
Fig. 000



DEAVER
OS1150284 22 mm
215 mm
Fig. 00



DEAVER
OS1150285 25 mm
235 mm
Fig. 0

Retractors



DEAVER 25 mm
OSI150286
300 mm
Fig. 1

DEAVER 25 mm
OSI150287
315 mm
Fig. 2

DEAVER 25 mm
OSI150288
365 mm
Fig. 2 1/2

Retractors



DEAVER 38 mm
OSI150289
300 mm
Fig. 3

DEAVER 50 mm
OSI150290
310 mm
Fig. 4

DEAVER 75 mm
OSI150291
320 mm
Fig. 5

Retractors



25 mm

1/2

DEAVER 28 mm
OSI150292
310 mm
Fig. 1



38 mm

1/2

DEAVER 38 mm
OSI150293
310 mm
Fig. 3

Retractors



DEAVER 50 mm
OS1150294
305 mm
Fig. 4



DEAVER 75 mm
OS1150295
310 mm
Fig. 5

Retractors for deep surgery (Abdominal Retractors)

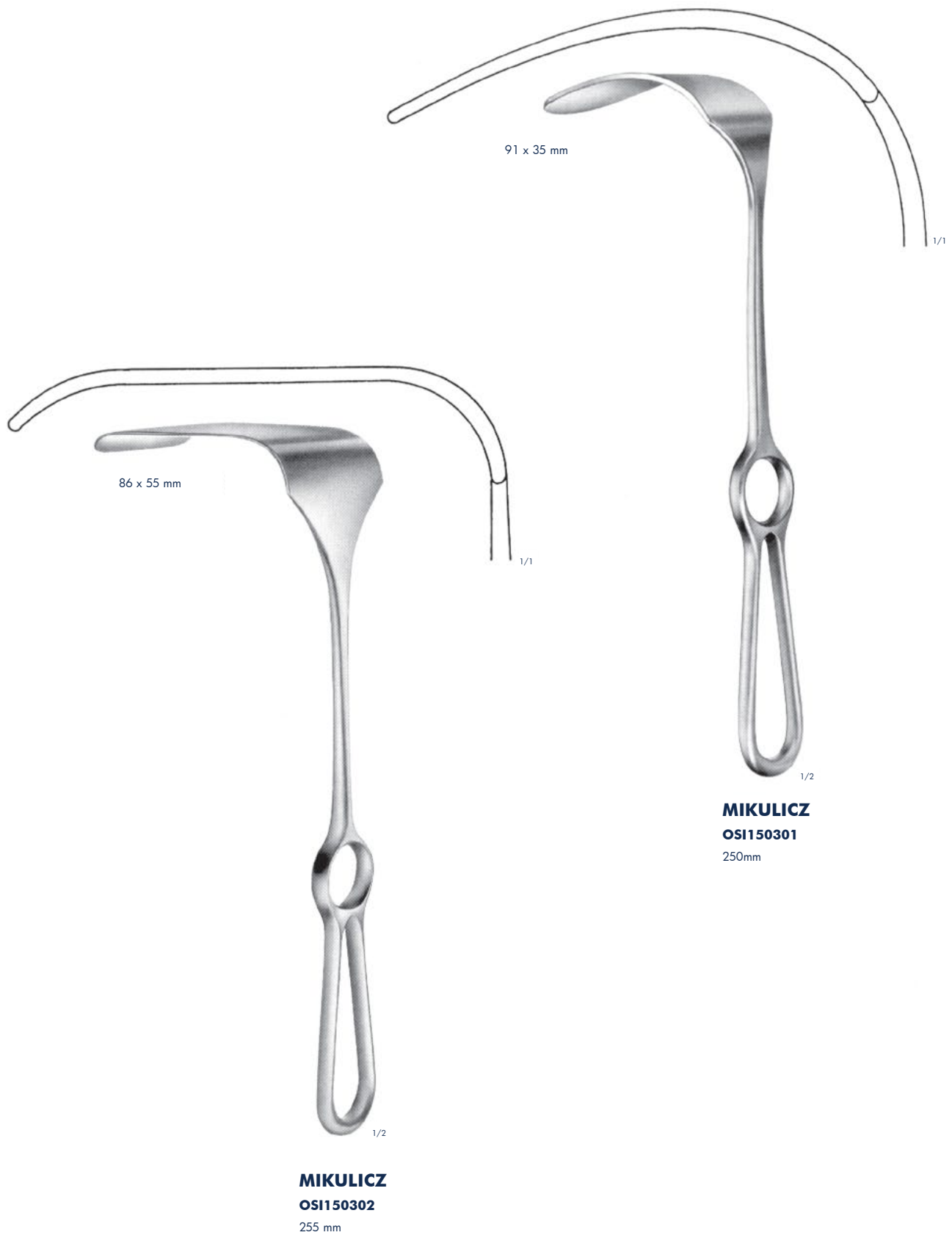

Retractors for deep surgery (Abdominal Retractors)



MIKULICZ

OSI150680 121 x 50 mm

OSI150681 147 x 50 mm

250 mm

OSI150682 180 x 50 mm

260 mm

Retractors for deep surgery (Abdominal Retractors)

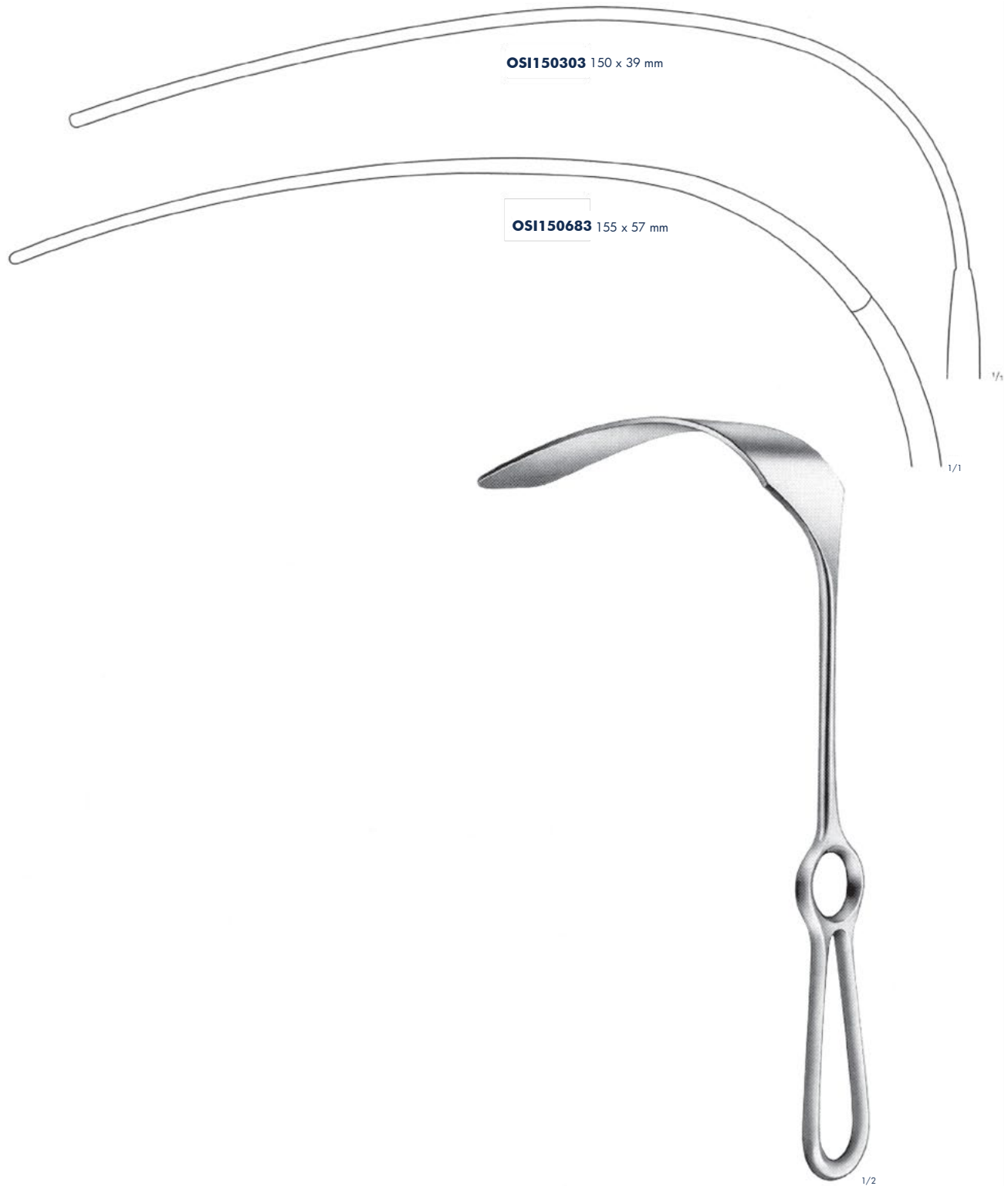

KELLY

OS1150303 150 x 39 mm

OS1150683 155 x 57 mm

260 mm

Retractors, Abdominal Retractors

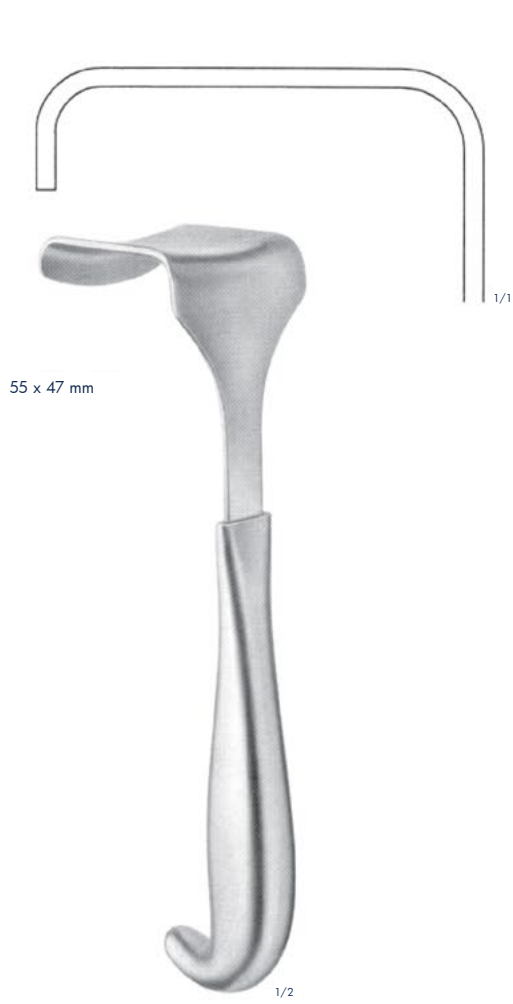

TUDOR - EDWARDS
OSI150684
205 mm



TUFFIER
OSI150263
215 mm

Retractors, Abdominal Retractors

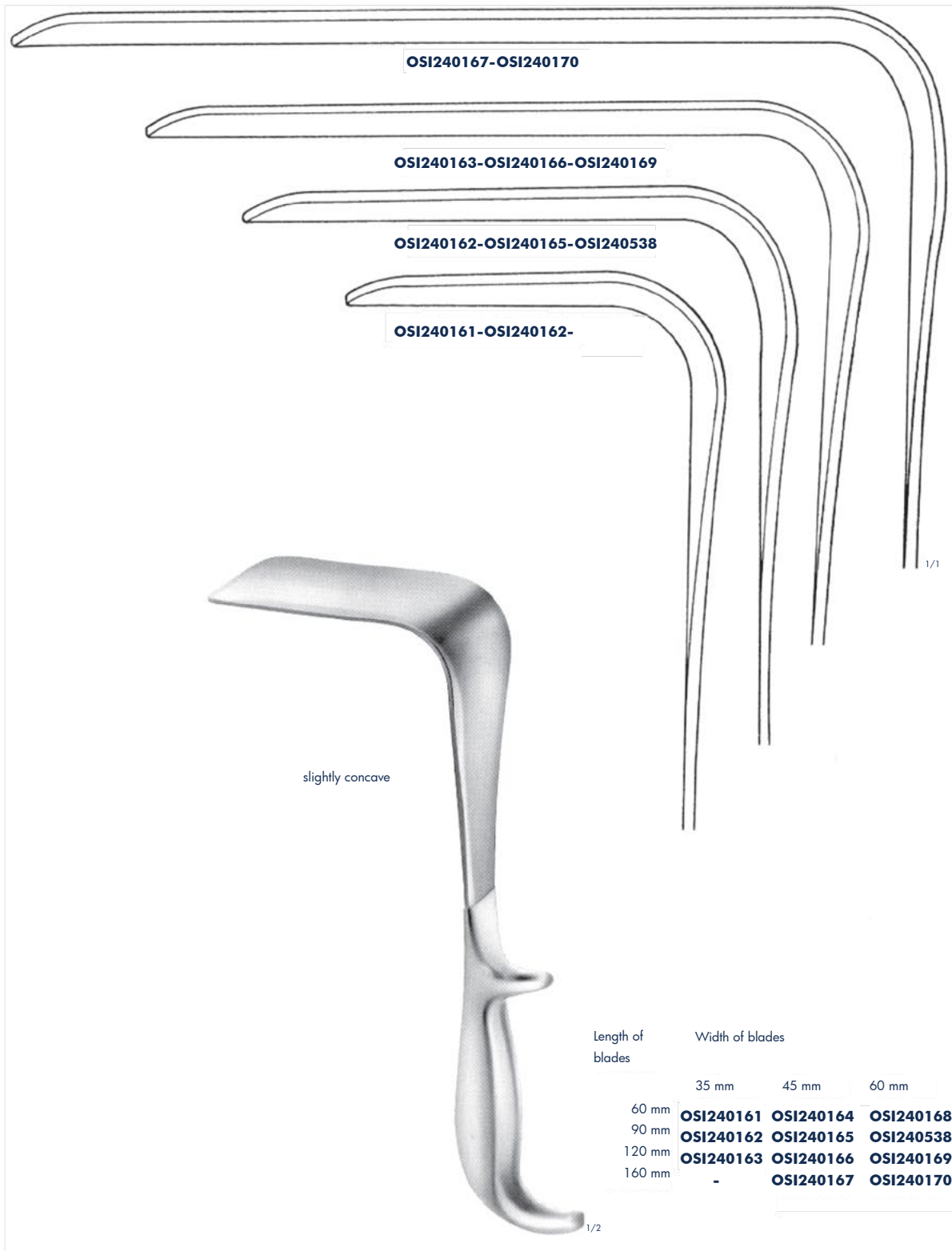

Length of blades	Width of blades		
	35 mm	45 mm	60 mm
60 mm	OSI240161	OSI240164	OSI240168
90 mm	OSI240162	OSI240165	OSI240538
120 mm	OSI240163	OSI240166	OSI240169
160 mm	-	OSI240167	OSI240170

DOYEN
OSI240161-OSI240170
 240 mm

Retractors, Abdominal Retractors

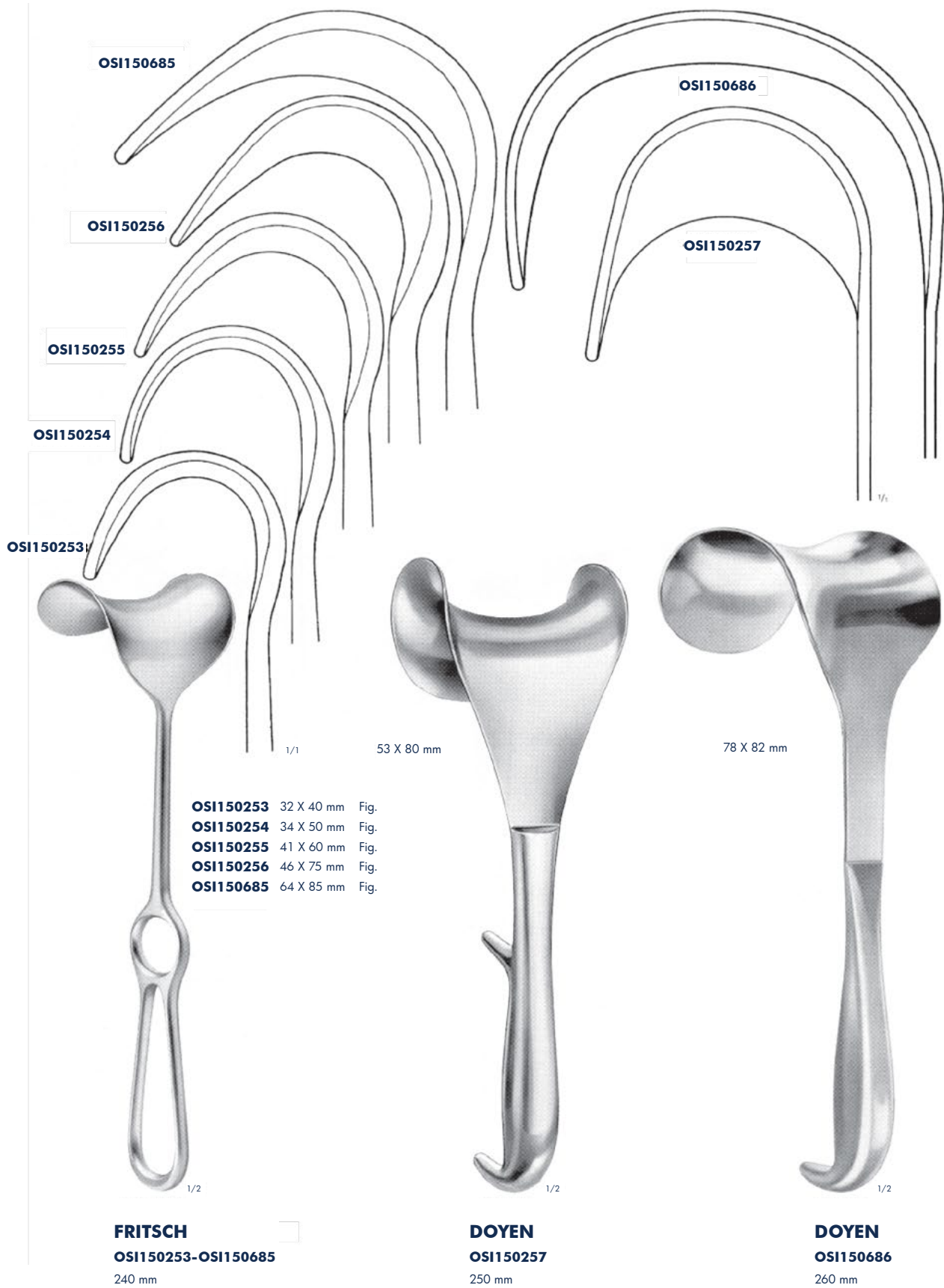

Abdominal Retractors

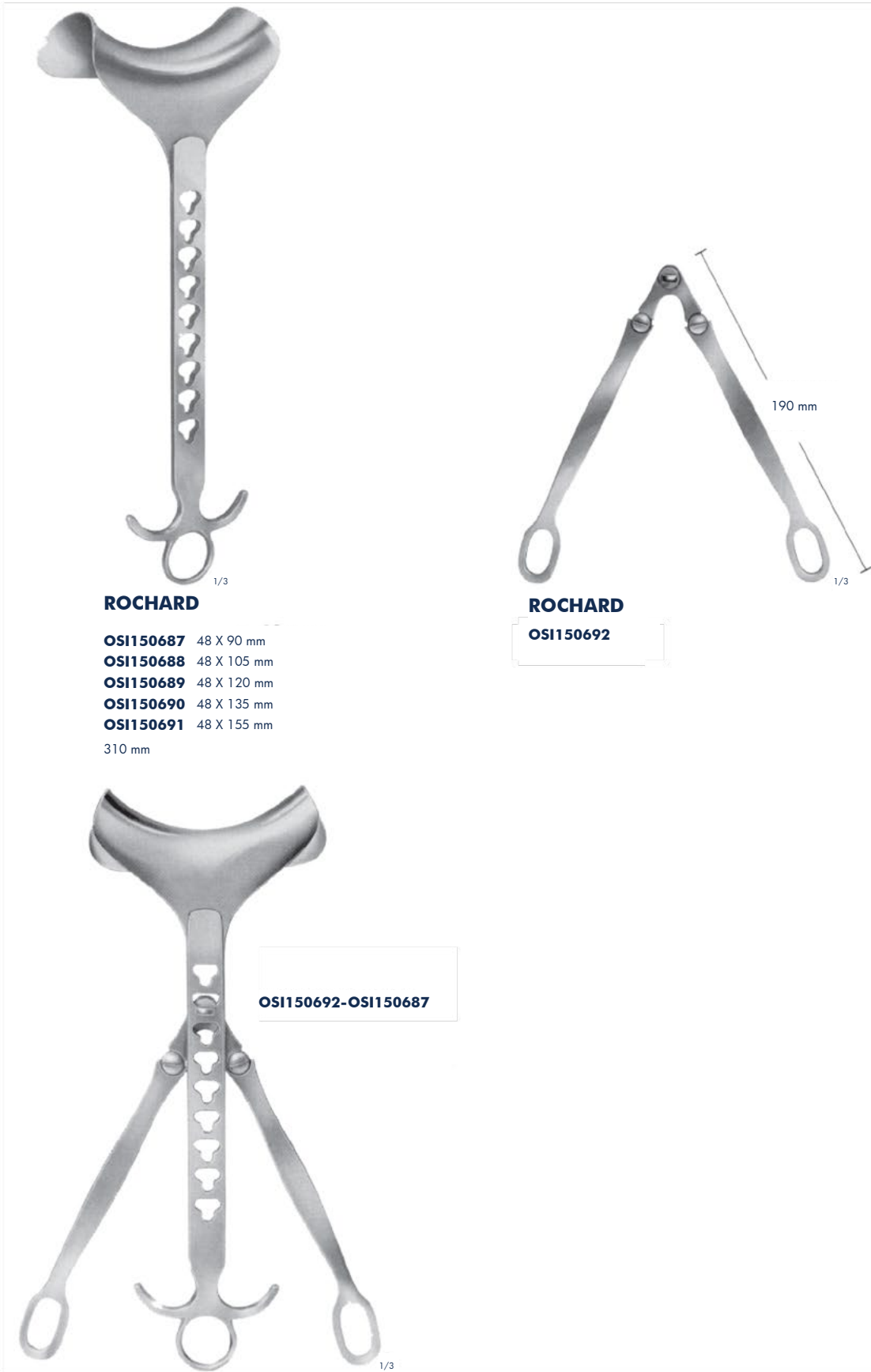

ROCHARD

- OSI150687** 48 X 90 mm
- OSI150688** 48 X 105 mm
- OSI150689** 48 X 120 mm
- OSI150690** 48 X 135 mm
- OSI150691** 48 X 155 mm

310 mm

ROCHARD

OSI150692

OSI150692-OSI150687

Abdominal Retractors

to be used with:

Fixation device and
and

ROCHARD abdominal retractors

OSI150693

Mountaing frame for fastening to the lateral bars of the operating tables, can be dismantled for decontamination and sterilisation.

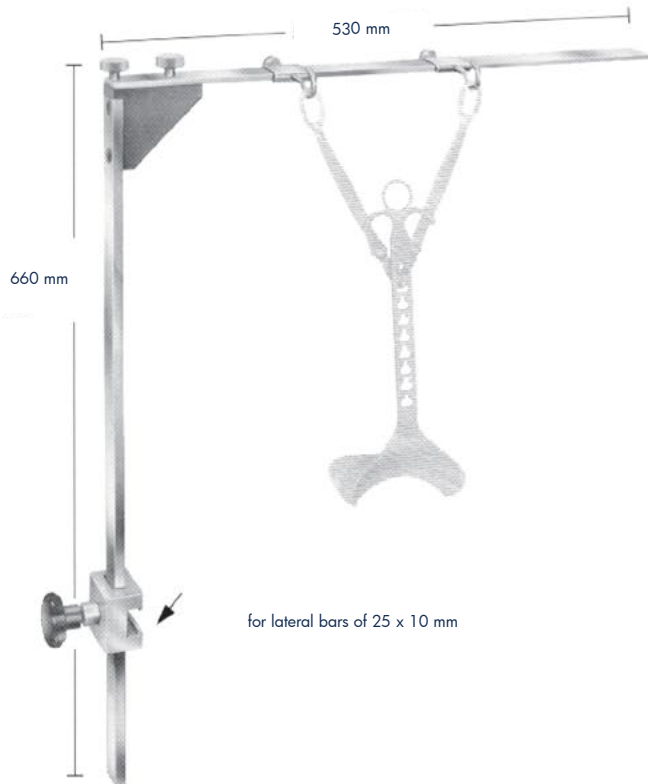

to be used with:

Fixation device and

ROCHARD abdominal retractors

OSI150694

Mountaing frame for fastening to the lateral bars of the operating tables, can be dismantled for decontamination and sterilisation.

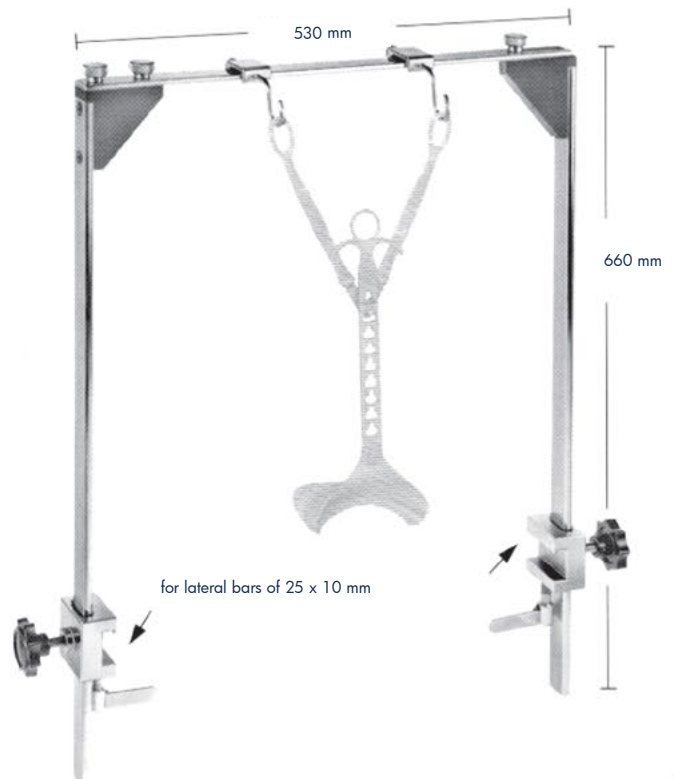

Abdominal Retractors



1/3

DOYEN

- OSI150695** 48 X 90 mm
 - OSI150696** 48 X 105 mm
 - OSI150697** 48 X 120 mm
 - OSI150698** 48 X 135 mm
- 280 mm



DOYEN-CHILD OSI150699

Fixation device
220 mm



OSI150700

790 mm

Pelvis Retractors

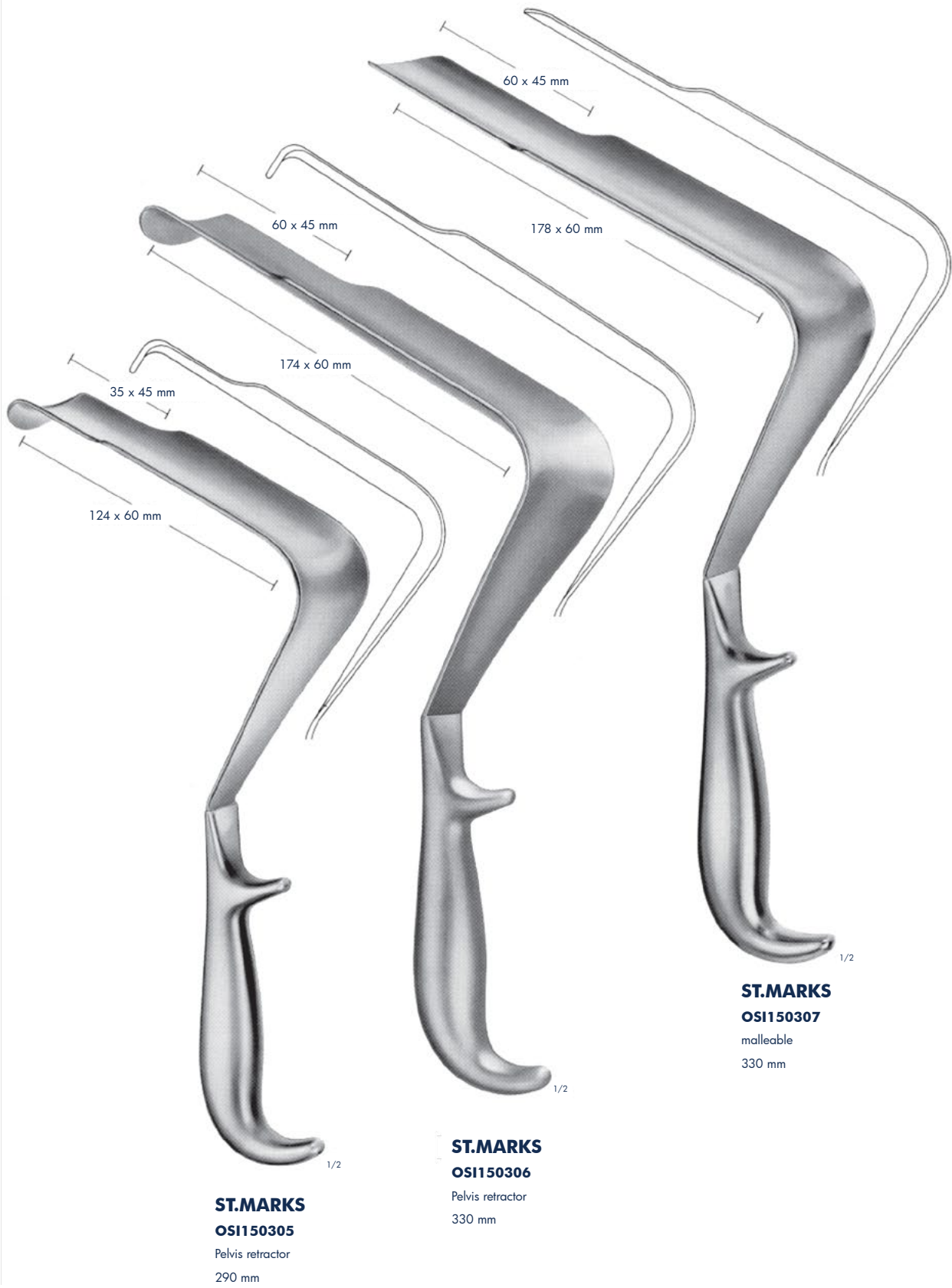

Abdominal and Intestinal Spatulas



LERICHE
OS1150701
255 mm

LERICHE
OS1150702
275 mm

KÜMMEL
OS1150703
malleable
285 mm

KÖRTE
OS1150704
300 mm

Abdominal and Intestinal Spatulas



MIKULICZ
OSI150705
 250 mm

KADER
OSI150705 30 mm
OSI150707 40 mm
 270 mm

OSI150708 30 mm
OSI150709 40 mm
OSI150710 50 mm
OSI150712 60 mm
 410 mm 70 mm

Abdominal and Intestinal Spatulas



REVERDIN
OSI150467
 285 mm



HABERER
OSI150713
 305 mm



OSI150714 30 mm
OSI150715 40 mm
OSI150716 50 mm
 330 mm



TUFFIER
OSI150471
 200 mm



OSI150474 200 x 12 mm
OSI150475 200 x 17 mm
OSI240672 250 x 25 mm

Depressor, Blood scoops



KOCHER
OSI150717

Depressor,
spoon shaped
220 mm



OSI150718
Blood scoop, 3 cu. inches



OSI150719
Blood scoop, 9 cu. inches

Self-Retaining Retractors



BOSE
OSI220105
60 mm



FINSEN
OSI150327
50 mm



FINSEN
OSI150329
70 mm



FINSEN modif.
OSI150720
75 mm



KILNER
OSI150721
small teeth
50 mm



FINSEN
OSI150722
70 mm



OSI150723
45 mm



OSI150724
55 mm



MUELLER
OSI150725
65 mm



OSI150326
100 mm



ALM
OSI150322
70 mm
OSI150325
100 mm



LOGAN
modif. REILL
OSI150331
30 mm

Self-Retaining Retractors, Lid Retractors



ALLPORT
OSI150737

95 mm



JANSEN
OSI150334

100 mm



JANSEN
OSI150335

100 mm



JANSEN
OSI150726

100 mm



OSI150730

OSI150731

OSI150732

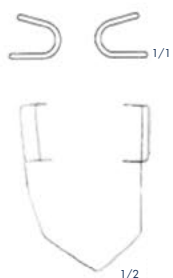

BARRAQUER
OSI150727

45 mm



SAUER
OSI150728

35 mm



LANCASTER
OSI150729

80 mm



MELLINGER
OSI150730-OSI150732

70 mm

Self-Retaining Retractors

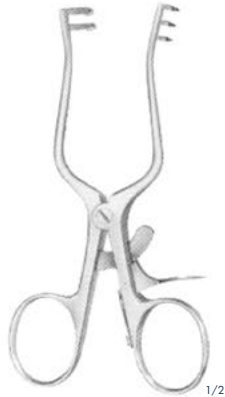

**WEITLANER
OSI150343**

110 mm
sharp



**WEITLANER
OSI150733**

110 mm
semi-sharp



**WEITLANER
OSI150344**

110 mm
blunt



**WEITLANER
OSI150345**

130 mm
sharp

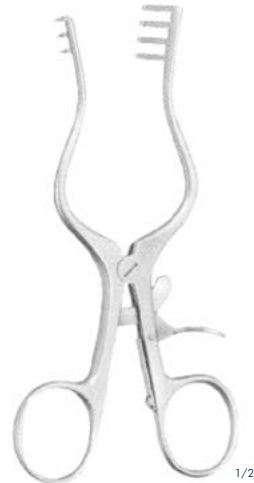

**WEITLANER
OSI150738**

130 mm
semi-sharp



**WEITLANER
OSI150346**

130 mm
blunt

Self-Retaining Retractors

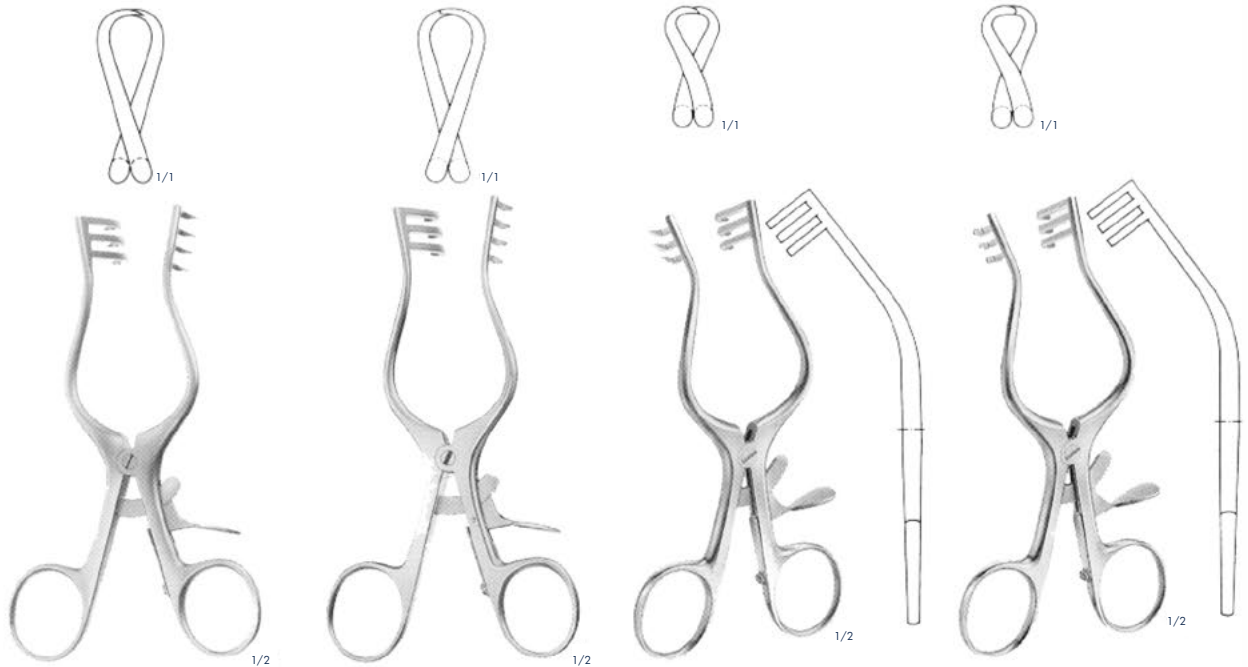

**WEITLANER
OSI150735**

130 mm
Sharp

**WEITLANER
OSI150736**

130 mm
Blunt

**WULLSTEIN
OSI150349**

130 mm
Sharp

**WULLSTEIN
OSI150350**

130 mm
Blunt

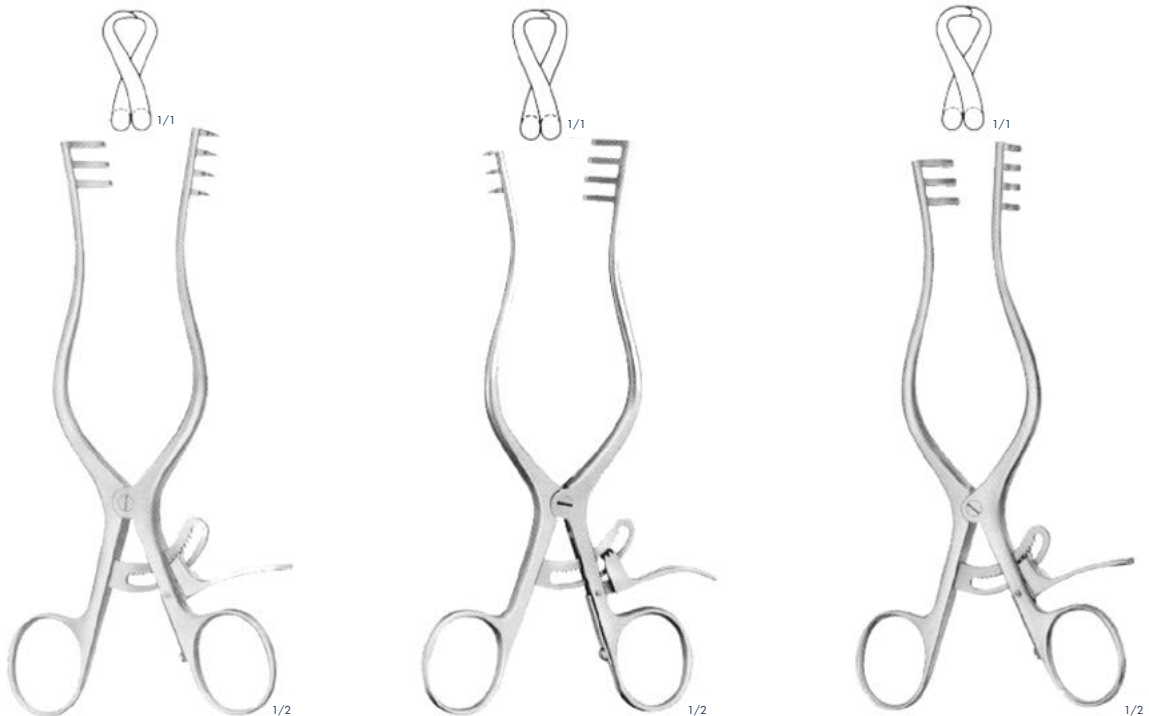

**WEITLANER
OSI150347**

165 mm
Sharp

**WEITLANER
OSI150734**

165 mm
Semi-sharp

**WEITLANER
OSI150348**

165 mm
Blunt

Self-Retaining Retractors



**PLESTER
OSI150354**

110 mm
Blunt



**PLESTER
OSI150355**

110 mm
Blunt

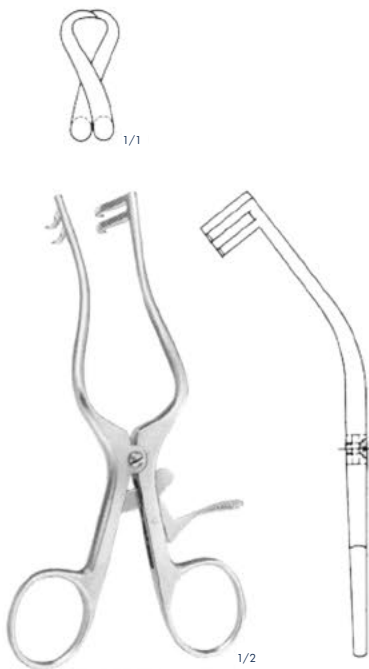

**PLESTER
OSI150353**

130 mm
Sharp

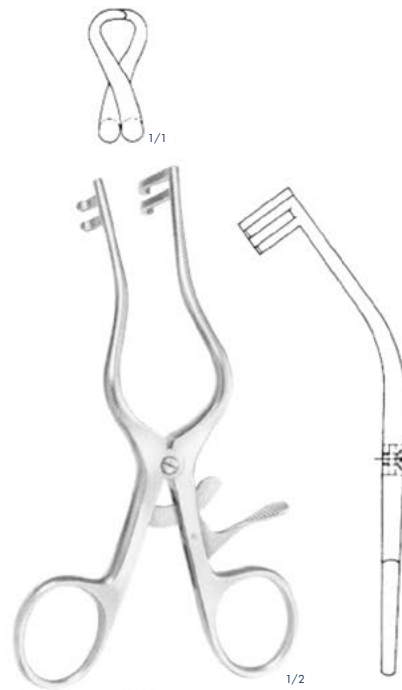

**PLESTER
OSI150352**

130 mm
Blunt

Self-Retaining Retractors

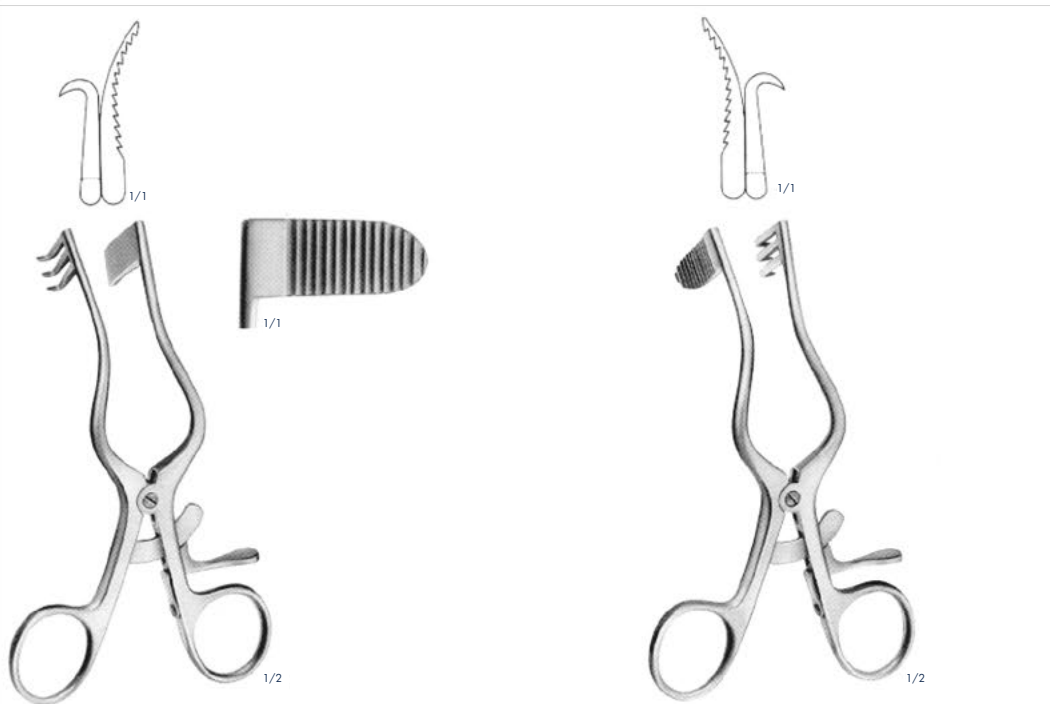

PERKINS
OS1150739
130 mm

PERKINS
OS1150740
130 mm

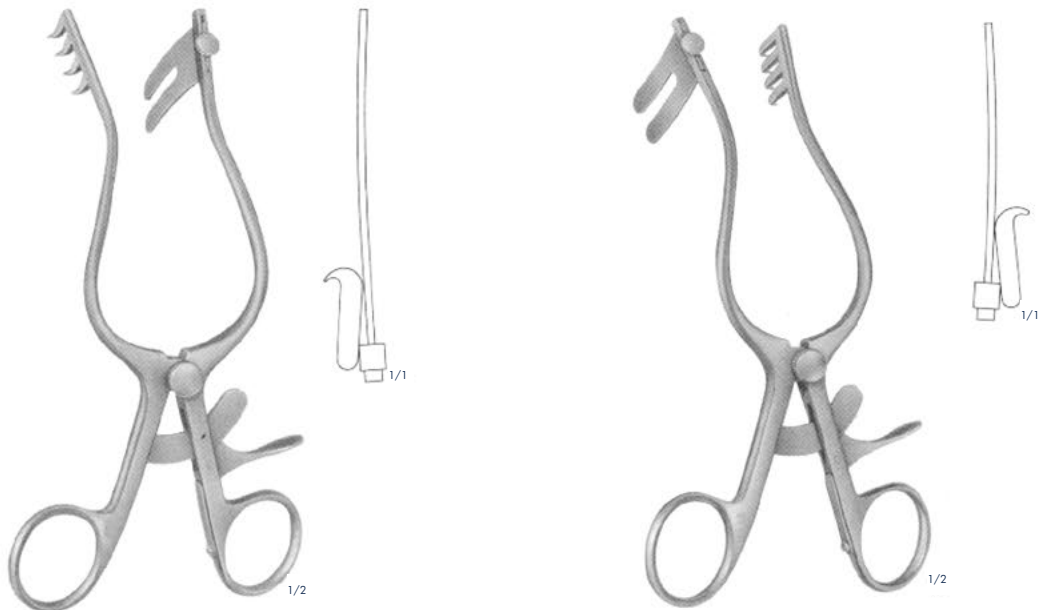

TALBOT
OS1150741
165 mm
Orbita-retractor, right

TALBOT
OS1150742
165 mm
Orbita-retractor, left

Self-Retaining Retractors



CAIRNS
OSI150743
 145 mm
 Sharp
 Swivel blade



RNTNE HOSPITAL
OSI150744
 165 mm
 Sharp



ADSON-BABY
OSI150745
 140 mm
 Semi-sharp



JEFFERSON
OSI150746
 140 mm
 covered, blunt



JEFFERSON
OSI150747
 140 mm
 sharp

Self-Retaining Retractors

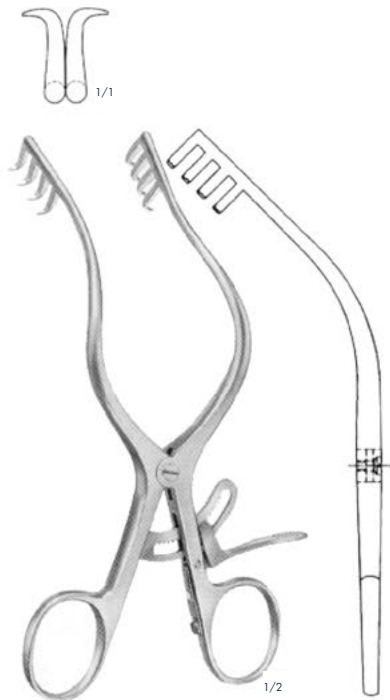

MOLLISON
OSI150351
 155 mm
 Sharp



TUBINGER MODELL
OSI150748
 165 mm

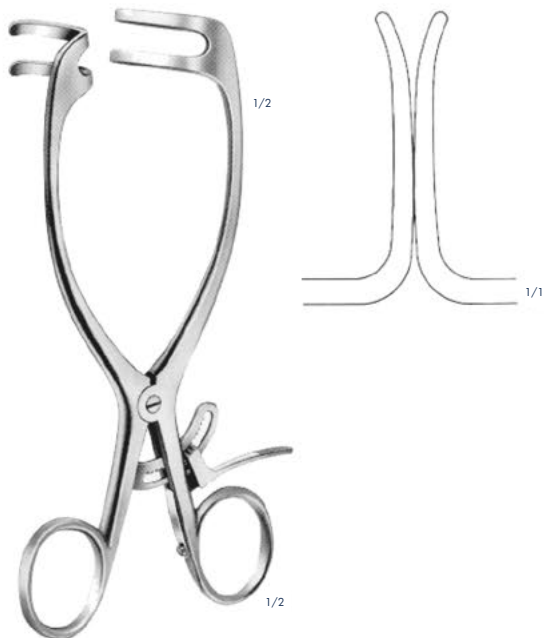

MAYO-ADAMS
OSI150749
 165 mm



HENDERSON
OSI150750
 170 mm
 Sharp

Self-Retaining Retractors



WEITLANER
OSI150337-OSI150754



OSI150337
195 mm
Sharp



OSI150751
195 mm
Sharp

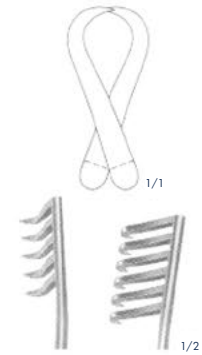

OSI150753
255 mm
Sharp



OSI150338
195 mm
Blunt



OSI150752
240 mm
Blunt

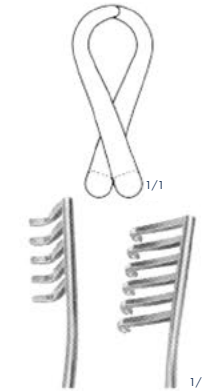

OSI150754
255 mm
Blunt



IRWIN
OSI150755
175 mm
Sharp



TRAVERS
OSI150756
215 mm
Blunt



Self-Retaining Laminectomy Retractors

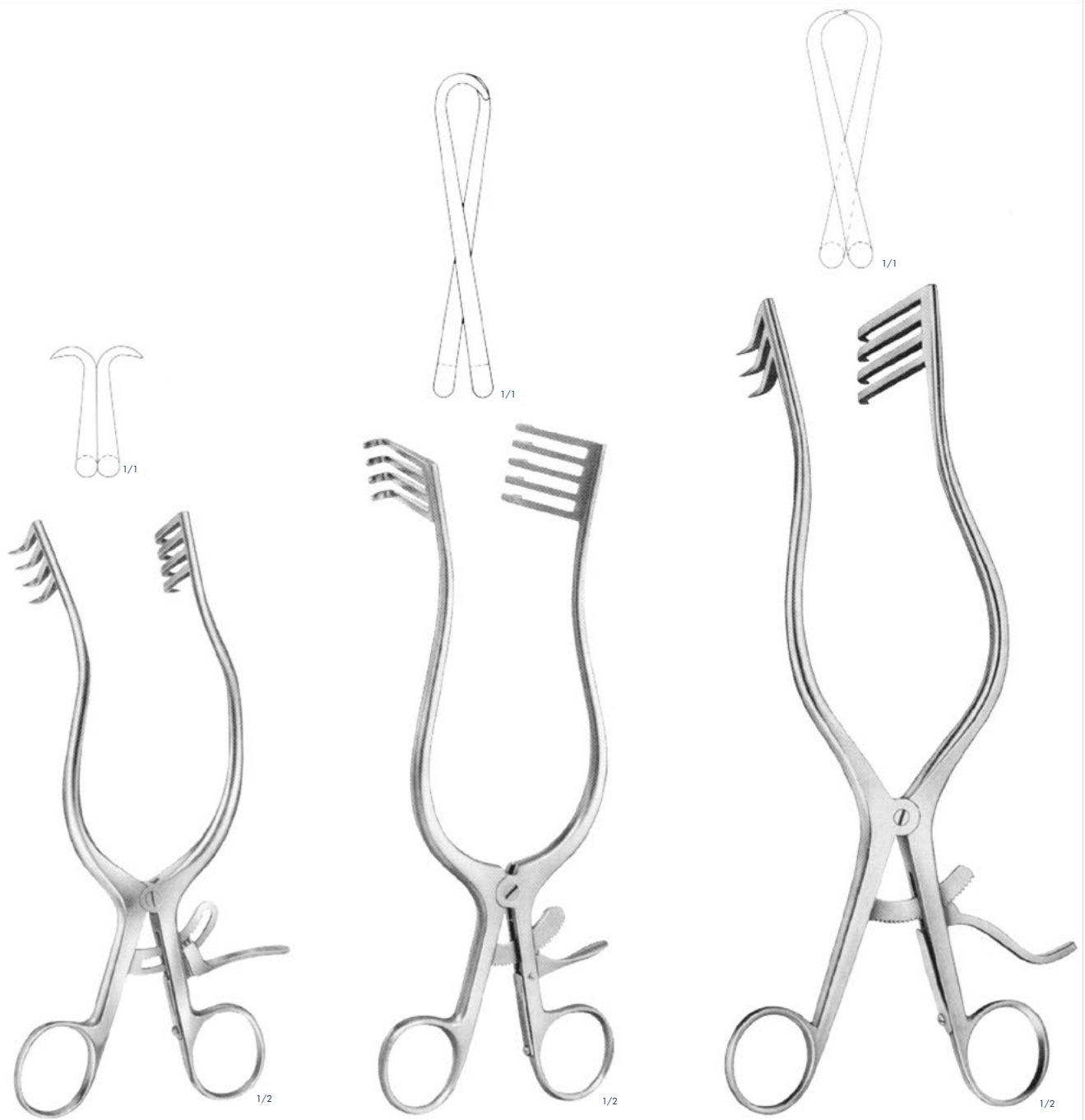

ANDERSON-ADSON
OSI150336
190 mm
Sharp

NORFOLK and NORWICH
OSI150757
220 mm
Blunt

ADSON
OSI150339
265 mm
Sharp

Self-Retaining Laminectomy Retractors

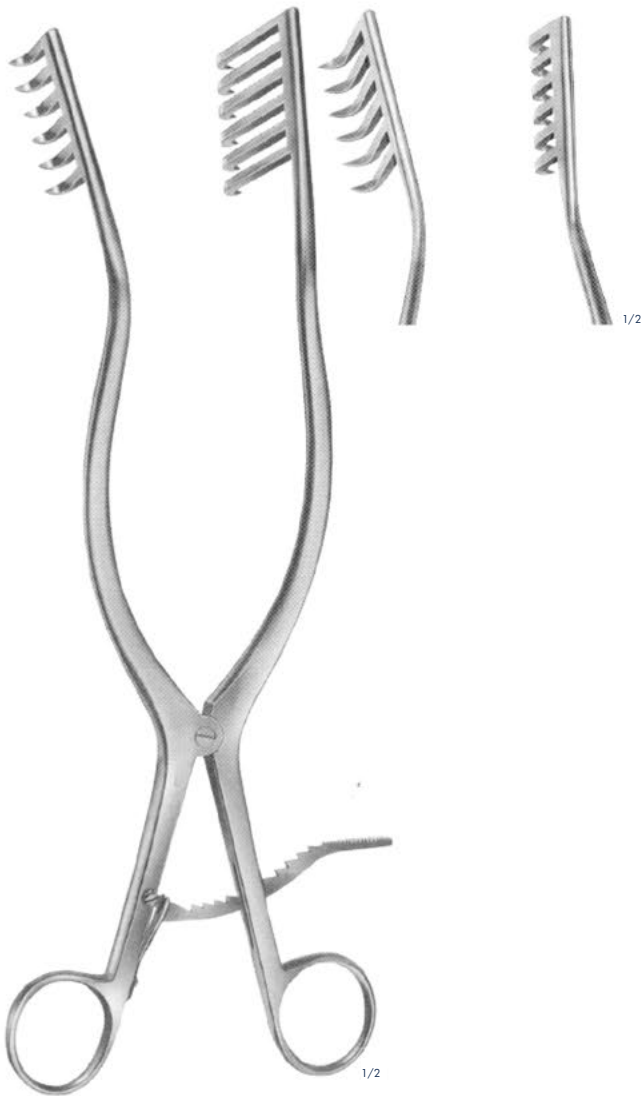

OSI150758
280 mm
Hemi-laminectomy retractor
Sharp

OSI150759
280 mm
Hemi-laminectomy retractor
Sharp



CONE
OSI150760
265 mm
Sharp

Self-Retaining Laminectomy Retractors

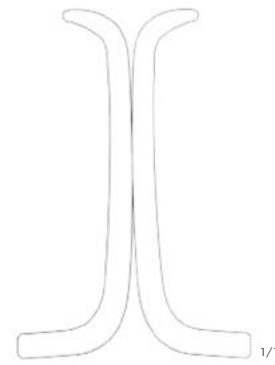
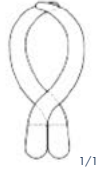

1/2

BECKMANN-ADSON
OS1150387
 310 mm
 Sharp



1/2

BECKMANN-ADSON
OS1150761
 310 mm
 Semi-sharp



1/2

HARVEY JACKSON
OS1150762
 280 mm
 Sharp

Self-Retaining Laminectomy Retractors



Special Retractors

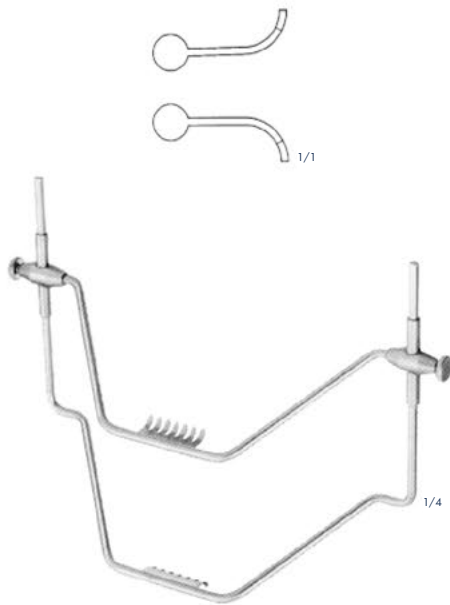

OSI150763

Thyroid retractor



JOLL (FRIEDMAN)
OSI150764

Thyroid and vaginal retractor
155 mm



JACKSON BURROWS
OSI150765

Retractor, blunt
185 mm



RICHTER
OSI150766

Vaginal retractor
170 mm

Special Retractors



GELPI
OSI150390

Vaginal retractor
135 mm



GELPI
OSI150391

Skin and vaginal retractor
175 mm



DE BAKEY
OSI150767

Femur retractor for children
100 mm



DE BAKEY
OSI150768

Femur retractor
145 mm

ALLENBERG Iliaca Spreader

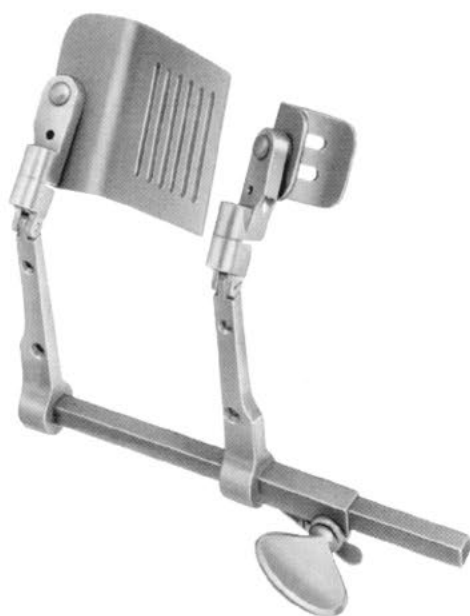

OSI150771



OSI150772

ALLENBERG OSI150769

Iliac Retractor

- consisting of:
- OSI150770 Sperrer allein
Retractor only
 - OSI150771 Retractor blade lateral, 30 x 30 mm
 - OSI150772 Retractor blade medial, 90 x 30 mm



OSI150773

Retractor system for optimal approach to the arteria iliaca communis. The retractor blades are made out of titanium and therefore they are radiotransparent. The big medial retractor blade can be gradually adjusted during the operation. Because of the blades which are easy to exchange the retractor system can be used for the left and right side.

Forceps for changing the blades

Self-Retaining Retractors for Laminectomy and other Applications

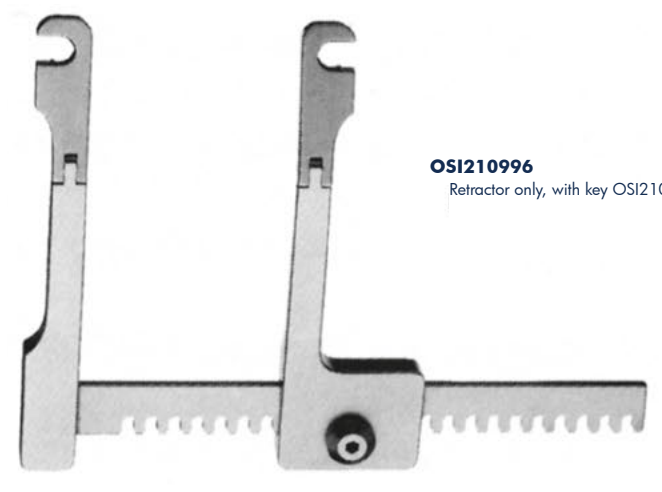

OSI210996
Retractor only, with key OSI210997



OSI210997
Screwdriver
15 cm

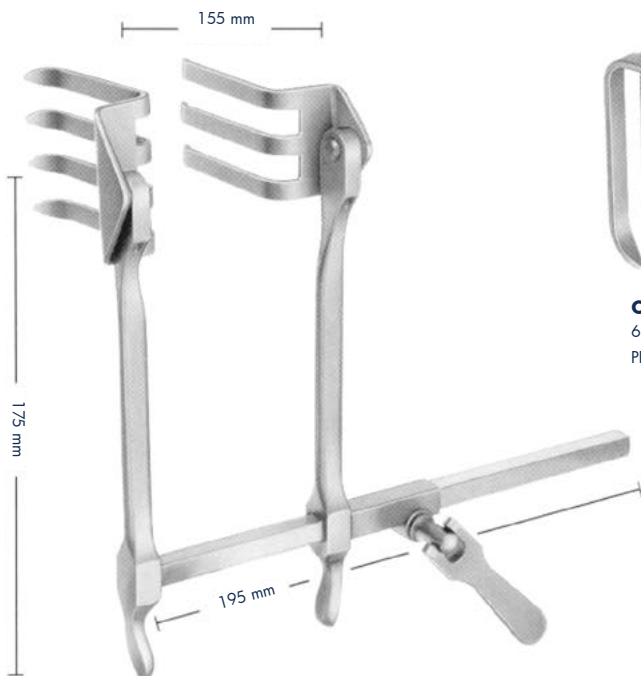

SCOVILLE RICHTER
OSI150774

Retractor only with 1 pair blades **OSI150775**
Reversible type. The retractor bar and shanks may be easily rotated 180° when blades are in situ.



OSI150776
62 x 52 mm
PR= Pair



62 x 37 mm



OSI150777
47 x 51 mm



OSI150778
30 x 40 mm



OSI150779
37 x 62 mm

Self-Retaining Retractors for Spine

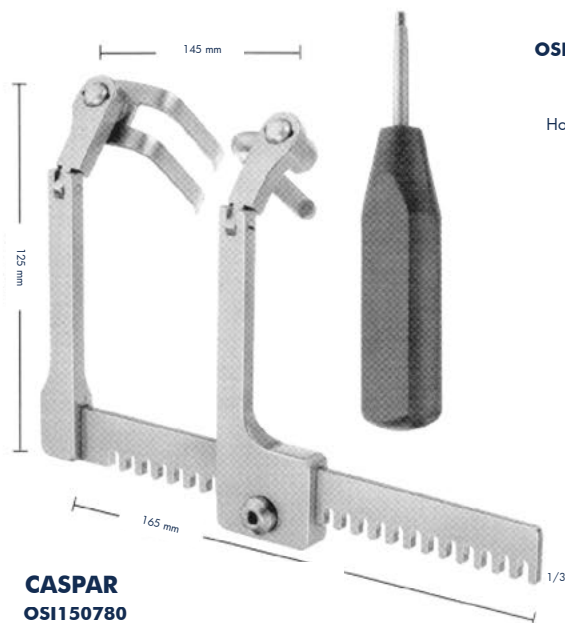

CASPAR
OSI150780

Retractor complete for laminectomy and hemi laminectomy, lumbar, thoracic and cervical available

Retractor only, with key ASO150781

- OSI150782** Hook 38 mm
- OSI150785** Blade 37 X 22 mm
- OSI150786** Blade 43 X 22 mm
- OSI150787** Blade 47 X 22 mm
- OSI150788** Blade 52 X 22 mm
- OSI150789** Blade 57 X 22 mm



OSI150782

Hook 38 mm



OSI150783

Hook 58 mm

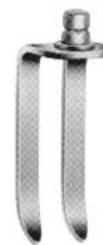

- OSI150784** 32 X 22 mm
- OSI150785** 37 X 22 mm
- OSI150786** 42 X 22 mm
- OSI150787** 47 X 22 mm
- OSI150788** 52 X 22 mm
- OSI150789** 57 X 22 mm
- OSI150790** 62 X 22 mm
- OSI150791** 67 X 22 mm

Blades



- OSI150792** 32 X 32 mm
- OSI150793** 37 X 32 mm
- OSI150794** 42 X 32 mm
- OSI150795** 47 X 32 mm
- OSI150796** 52 X 32 mm
- OSI150797** 57 X 32 mm
- OSI150798** 62 X 32 mm
- OSI150799** 67 X 32 mm

Blades



- OSI150800** 32 X 52 mm
- OSI150801** 37 X 52 mm
- OSI150802** 42 X 52 mm
- OSI150803** 47 X 52 mm
- OSI150804** 52 X 52 mm
- OSI150805** 57 X 52 mm
- OSI150806** 62 X 52 mm
- OSI150807** 67 X 52 mm

Blades

CASPAR Universal Retractor System

Universal Spinal Retractor System

The self-retaining CASPAR universal spinal retractor permits safe retraction and saves space in the operation area due to the removable handles.

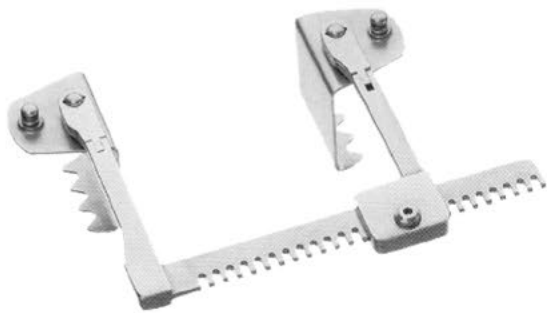

CASPAR

OSI150808

Retractor

OSI150809

Handle

OSI150810 50 X 44 mm

OSI150811 50 X 54 mm

OSI150812 50 X 74 mm

OSI150813 50 X 89 mm



Blades

OSI150781

Key for socket-head screw,
without illustration



Self-Retaining Retractors for Laminectomy and other Applications



SCOVILLE
OSI150454
55 mm



SCOVILLE
OSI150458 63 x 25 mm
OSI150459 63 x 51 mm



TAYLOR
OSI150461
47 x 37 mm



TAYLOR
OSI150462
62 x 52 mm

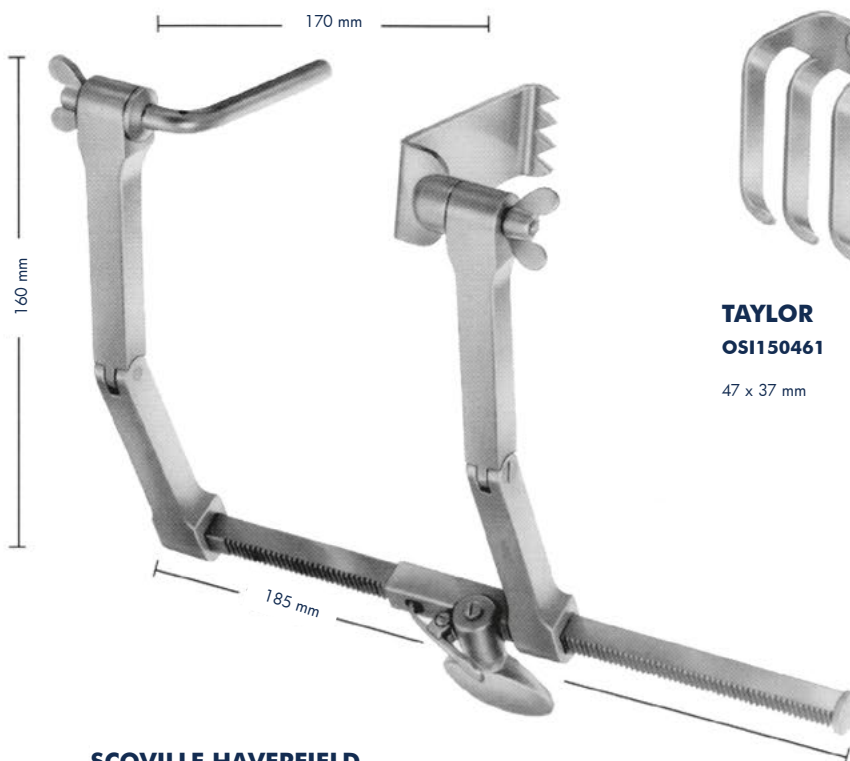

SCOVILLE HAVERFIELD
OSI150453

consisting of:
1 OSI150999 Frame only
1 OSI150454 Hook
1 OSI150458 Blade

Retractors for cervical Spine

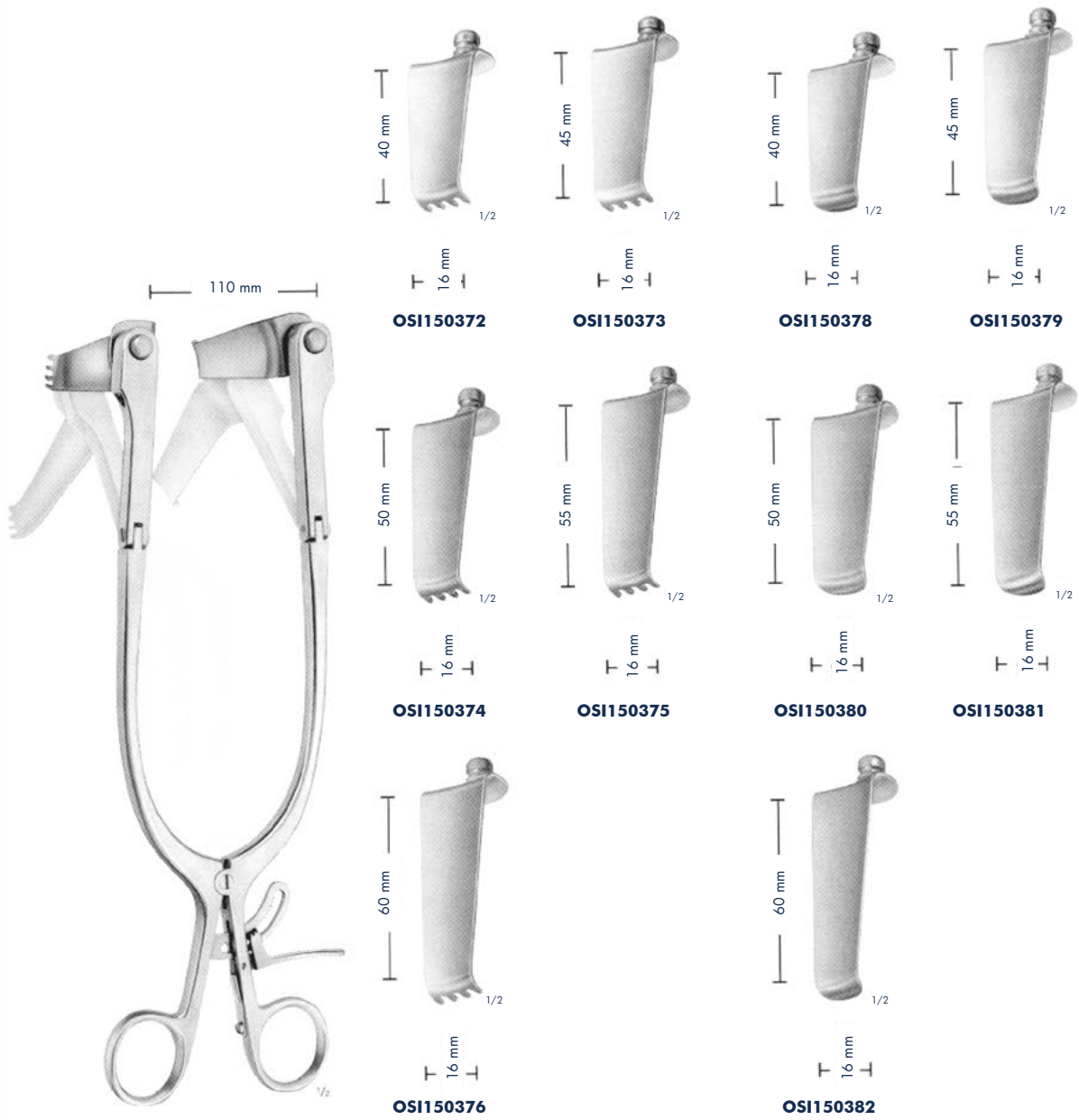

CLOWARD modif.

OSI150371

- consisting of:
- OSI240673 Spreader only, 250 mm
- OSI150672 Blade
- OSI150673 Blade
- OSI150674 Blade
- OSI150675 Blade
- OSI150676 Blade

Blade only for OSI240673

Retractors -System

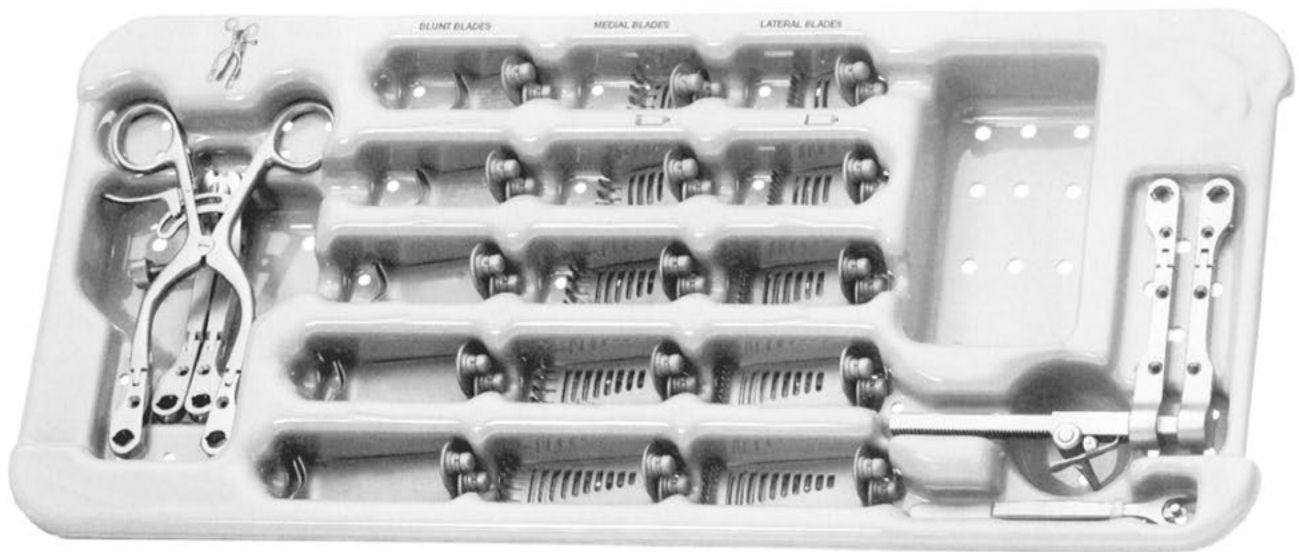

OSI240674

CCR RETRACTOR SET

complete
Content:
(one of each)

OSI150868 CCR Instrument Tray, only

OSI150815 CASPAR cervical tissue retractor for transverse retraction

OSI150867 Forceps for changing the blades with ball snap closure

OSI150817 CASPAR cervical tissue counter for longitudinal retraction

OSI150819 CASPAR cervical tissue counter for longitudinal retraction

OSI150857 for longitudinal retraction

OSI150866 Medial blades fenestrated (Titanium)
for transverse retraction

OSI150837

OSI150846 Lateral blades fenestrated (Titanium)

OSI150847 for transverse retraction

OSI150856

Retractors for cervical Spine

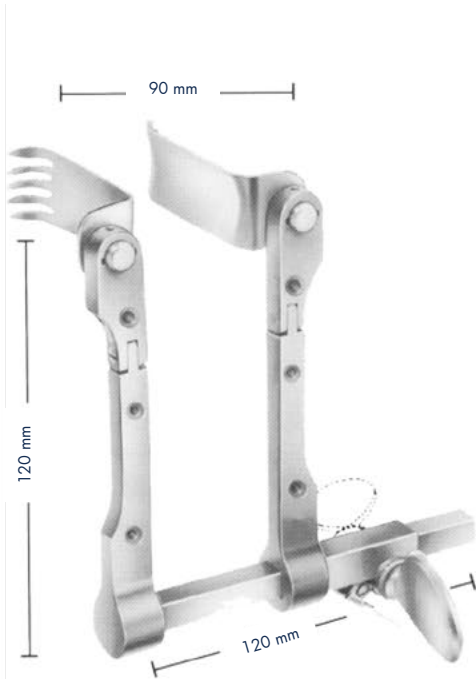

CASPAR
OSI150814

Retractor, adjustable, consisting of: 5 medial blades OSI150820-OSI150824
5 lateral blades OSI150825-OSI150829 and the retractor only OSI150815
By reversing the screw, the retractor can be used from both sides.

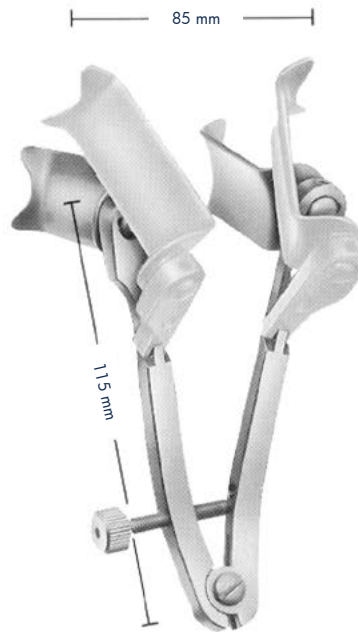

CASPAR
OSI150816

Retractor(speculum pattern), adjustable, consisting of: 5 blades OSI150830-OSI150834 and the retractor only OSI150817
By reversing the screw, the retractor can be used from both sides.



CASPAR
OSI150818

Counter retractor, adjustable, consisting of: 5 blades OSI150830-OSI150834 and the retractor only OSI150819



OSI210992
Duble hinged cervical retractor



OSI210993
Duble hinged cervical retractor used for longitudinal retraction



OSI210994
Counter retractor

Retractors for cervical Spine



- OSI150820** 40 X 23 mm
- OSI150821** 45 X 23 mm
- OSI150822** 50 X 23 mm
- OSI150823** 55 X 23 mm
- OSI150824** 60 X 23 mm

medial blades



- OSI150825** 40 X 23 mm
- OSI150826** 45 X 23 mm
- OSI150827** 50 X 23 mm
- OSI150828** 55 X 23 mm
- OSI150829** 60 X 23 mm

lateral blades



- OSI150830** 45 X 23 mm
- OSI150831** 50 X 23 mm
- OSI150832** 55 X 23 mm
- OSI150833** 60 X 23 mm
- OSI150834** 65 X 23 mm

blunt blades



- OSI150835** 50 X 25 mm
- OSI150836** 60 X 25 mm

Blunt blades, for harvesting of the fusion graft from the iliac crest

Retractors for cervical vertebral Column



- OSI150837** 25 X 24 mm
- OSI150838** 30 X 24 mm
- OSI150839** 35 X 24 mm
- OSI150840** 40 X 24 mm
- OSI150841** 45 X 24 mm

- OSI150842** 50 X 24 mm
- OSI150843** 55 X 24 mm
- OSI150844** 60 X 24 mm
- OSI150845** 65 X 24 mm
- OSI150846** 70 X 24 mm

Medial blades

Titanium blades, fenestrated and semi-transparent to X-Ray; to be used with (transverse retraction)



- OSI150847** 25 X 24 mm
- OSI150848** 30 X 24 mm
- OSI150849** 35 X 24 mm
- OSI150850** 40 X 24 mm
- OSI150851** 45 X 24 mm

- OSI150852** 50 X 24 mm
- OSI150853** 55 X 24 mm
- OSI150854** 60 X 24 mm
- OSI150855** 65 X 24 mm
- OSI150856** 70 X 24 mm

Lateral blades

Titanium blades, semi-transparent to X-Ray; to be used with (longitudinal retraction)



- OSI150857** 30 X 24 mm
- OSI150858** 35 X 24 mm
- OSI150859** 40 X 24 mm
- OSI150860** 45 X 24 mm
- OSI150861** 50 X 24 mm

- OSI150862** 55 X 24 mm
- OSI150863** 60 X 24 mm
- OSI150864** 65 X 24 mm
- OSI150865** 70 X 24 mm
- OSI150866** 75 X 24 mm

Titanium blades, semi-transparent to X-Ray; to be used with (longitudinal retraction)



OSI150867

Blade ejector for changing the blades with ball snap closure 115 mm



OSI210995
Handle for blades
with side load attachment

MLD Retractor Set

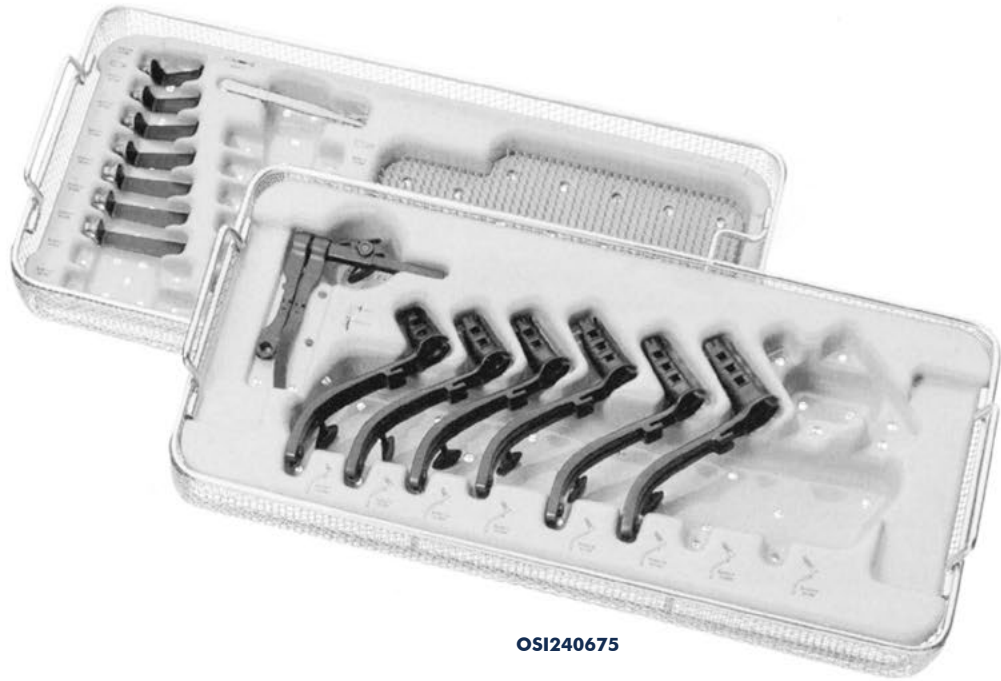

OSI240675

Spine Classics MLD Retractor Set

complete
consisting of:
(one of each)

- OSI150869** Spine Classics MLD Tray I, only
- OSI150870** Speculum 40 mm
- OSI150871** Speculum 45 mm
- OSI150872** Speculum 50 mm
- OSI150873** Speculum 55 mm
- OSI150874** Speculum 60 mm
- OSI150875** Speculum 65 mm
- OSI150878** Counter retractor, only

- OSI150676** Spine Classics MLD Tray II, only
- OSI150879** Blade 35 mm
- OSI150880** Blade 40 mm
- OSI150881** Blade 45 mm
- OSI150882** Blade 50 mm
- OSI150883** Blade 55 mm
- OSI150884** Blade 60 mm
- OSI150885** Blade 65 mm
- OSI150867** Forceps for changing blades
with Ball Snap Closure

Retractors for Micro Lumbar Discectomy

Surface black coated

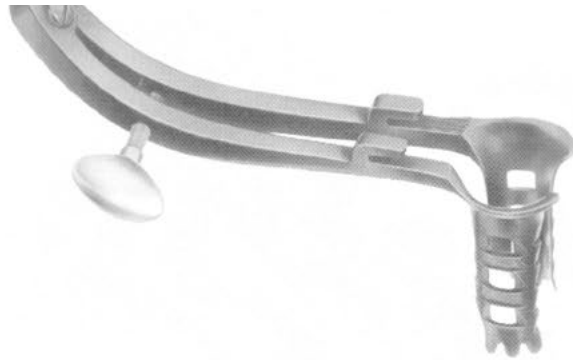

CASPAR

OSI150870-OSI150877

Specula for microsurgical lumbar discectomy



Ref. no	Length of Blade
OSI150870	40 mm
OSI150871	45 mm
OSI150872	50 mm
OSI150873	55 mm
OSI150874	60 mm
OSI150875	65 mm
OSI150876	75 mm
OSI150877	85 mm

Retractors for Mikro-Lumbar-Discectomy

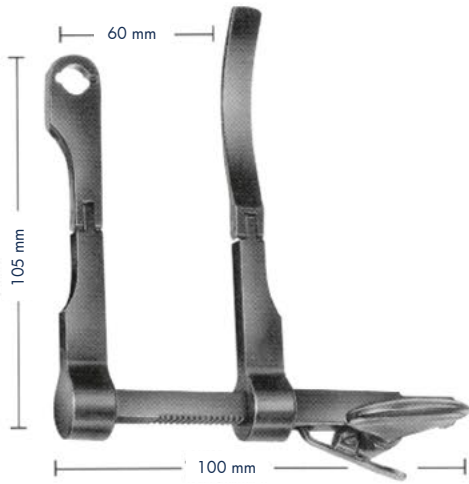

CASPAR
OSI150878

Counter-retractor

Ref. no	Length of Blade
OSI150879	35 mm
OSI150880	40 mm
OSI150881	45 mm
OSI150882	50 mm
OSI150883	55 mm
OSI150884	60 mm
OSI150885	65 mm
OSI150886	75 mm
OSI150887	85 mm

Blades, lateral, surface black-coated



Ref. no	Length of Blade
OSI150888	40 mm
OSI150889	45 mm
OSI150890	50 mm
OSI150891	55 mm
OSI150892	60 mm
OSI150893	65 mm
OSI150894	70 mm

Blades, medial, surface black-coated



Lamina Spreaders



CLOWARD
OSI210219
155 mm



CLOWARD
OSI210895
135 mm

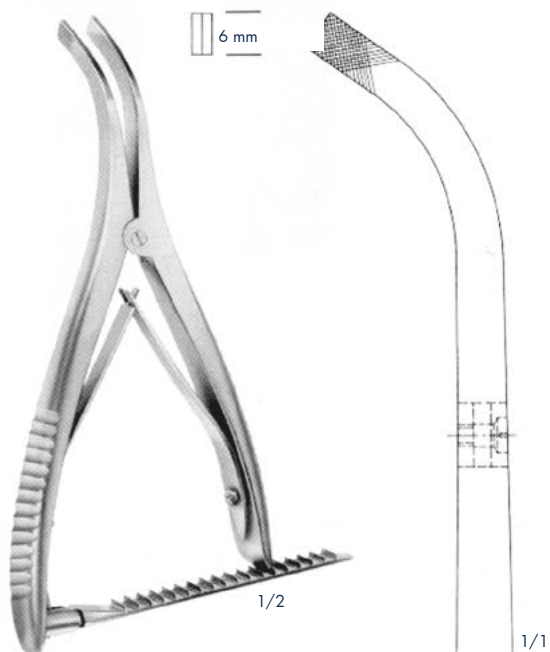

INGE
OSI210220
170 mm

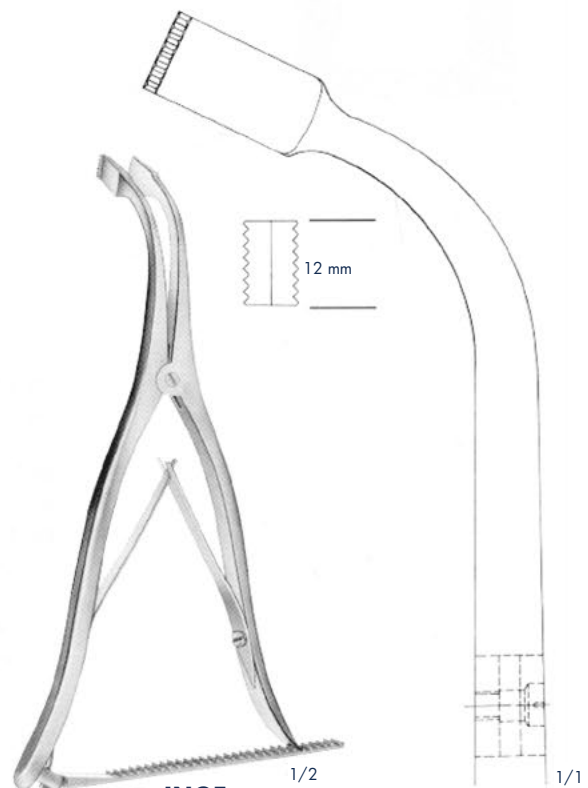

INGE
OSI210221
275 mm

Abdominal Retractors



BABY-COLLIN
OSI150395
complete

consisting of:

- OSI150994** Spreader only
- OSI240677** Blades (pair)
- OSI240678** Blades (pair)

OSI240677
Blades (pair)
18 x 42 mm

OSI150994
Retractor, only

OSI240678
Blades (pair)
28 x 42 mm

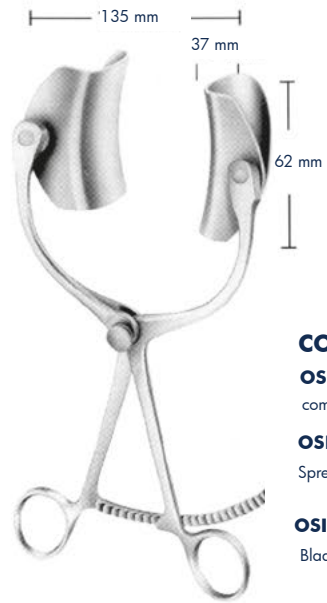

COLLIN
OSI150396
complete

OSI240679
Spreader only

OSI150898
Blades (pair)



COLLIN
OSI150397 - OSI240683

complete complete complete



COLLIN
OSI150399 - OSI240689

OSI150399 complete **OSI240698** complete

Spreader only

Lateral blades (pair)

37x62 mm 37 x 80 mm 37 x 98 mm

Center blade

54 x 55 mm 54 x 67 mm 52 x 76 mm

Spreader only

Lateral blades (pair)

48 x 59 mm 61 x 80 mm

Center blade

63 x 74 mm 63 x 74 mm

Abdominal Retractors



ROBIN-MASSE
OSI150896
complete

- Spreader only **OSI240692**
- Lateral blades (pair) **OSI150898**
37 x 62 mm
- Center blade **OSI240693**
38 x 66 mm



RICARD
OSI150400 -

- | | | |
|-----------------------|------------------|------------------|
| | complete | complete |
| | OSI150400 | OSI150401 |
| Spreader only | OSI150402 | OSI150402 |
| Lateral blades (pair) | OSI150403 | OSI150404 |
| | 58 x 80 mm | 72 x 84 mm |
| Center blade | OSI150405 | OSI150406 |
| | 54 x 70 mm | 72 x 90 mm |



HOLZBACH
OSI150897
complete

Spreader only

- Lateral blades (pair) **OSI150905**
59 x 80 mm
- Center blade **OSI240695**
74 x 82 mm

Abdominal Blades

Sales unit of blades: PR = pair

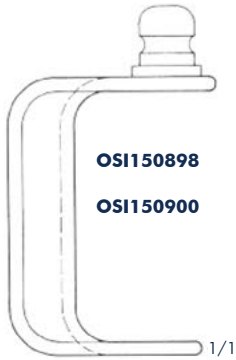

OSI150898
OSI150900

1/1

Lateral blades only

OSI150898 37 x 62 mm
OSI150899 37 x 80 mm
OSI150900 37 x 98 mm

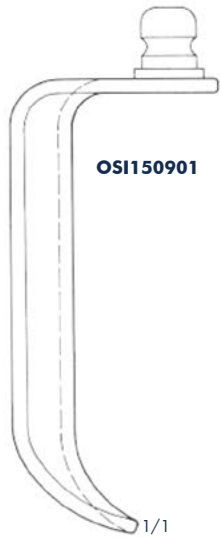

OSI150901

1/1

OSI150901 61 x 80 mm

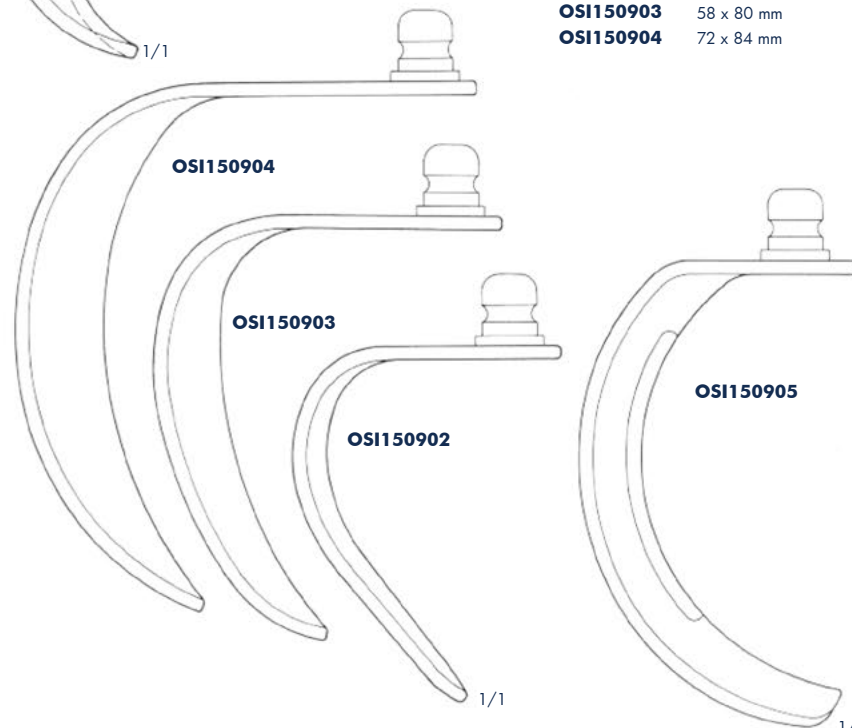

OSI150904

OSI150903

OSI150902

OSI150905

1/1

1/1

OSI150902 48 x 59 mm
OSI150903 58 x 80 mm
OSI150904 72 x 84 mm



OSI150905 59 x 80 mm

Adjustable Retractor Blades



OSI150906 50 - 60 x 40 mm

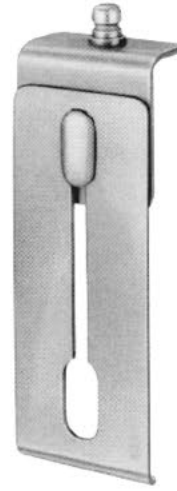

OSI150908 50 - 110 x 40 mm

Abdominal Retractors

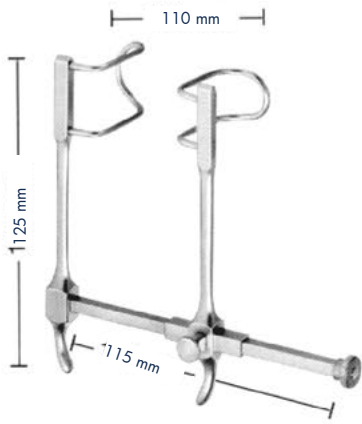

GOSSET
OS1150421

Blades: 38 mm deep

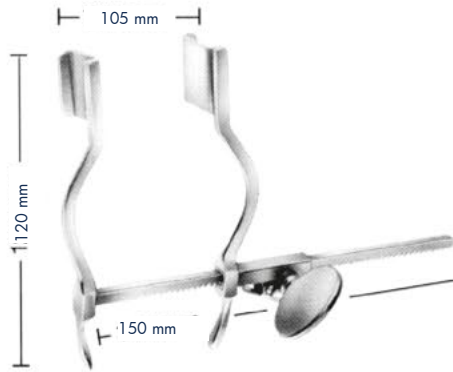

HERTZLER
OS1150909

Blades: 20 x 25 mm

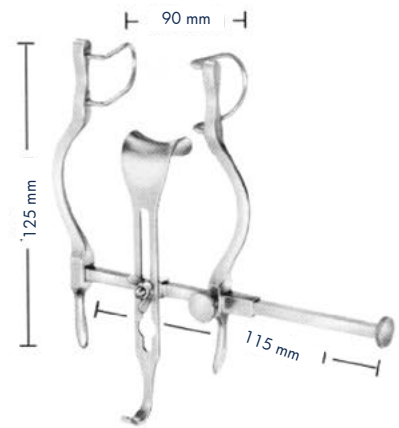

BALFOUR-BABY
OS1150424

Lateral blades : 27 mm deep
OS1240696
Center blade 21 x 24 mm

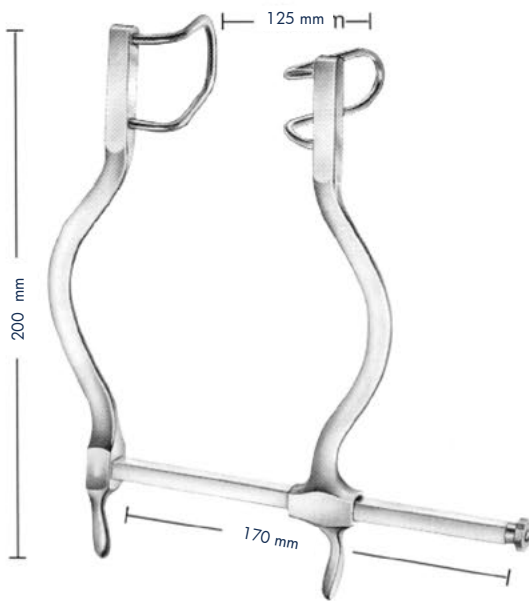

GOSSET
OS1150423

Blades: 55 mm deep



GOSSET
OS1150422

Lateral blades 58 mm deep
OS1240697
Center blade 59 x 57 mm

Abdominal Retractors

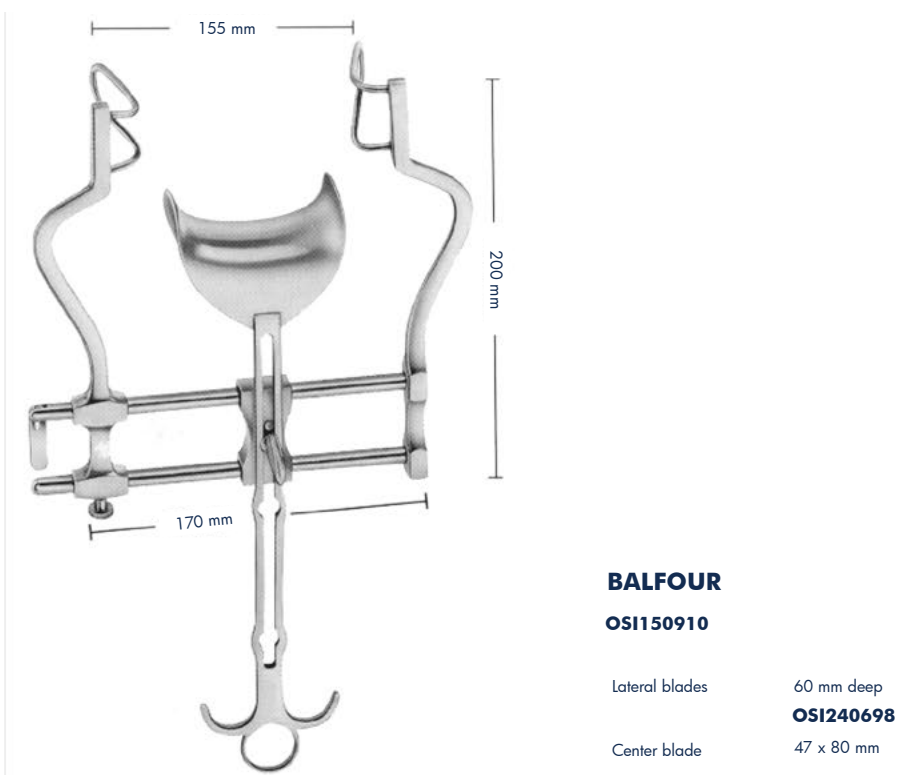

BALFOUR
OSI150910

Lateral blades 60 mm deep
OSI240698
Center blade 47 x 80 mm

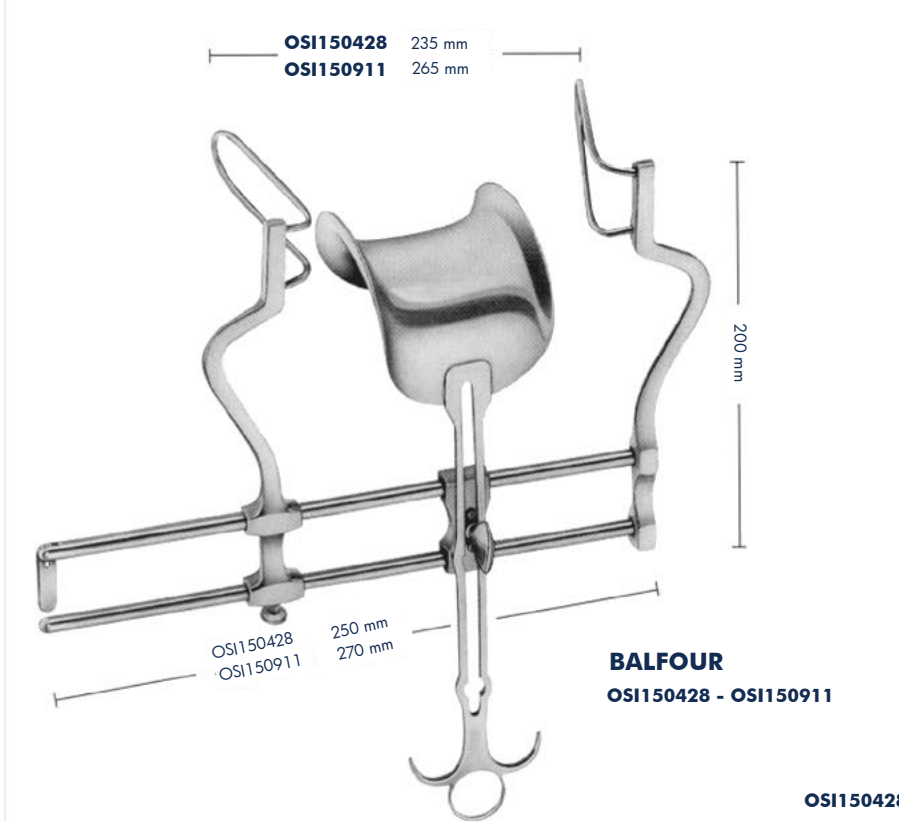

BALFOUR
OSI150428 - OSI150911

	OSI150428	OSI150911
Lateral blades	60 mm deep	90 mm deep
	OSI240699	OSI240700
Center blade	62 x 76 mm	80 x 80 mm

Abdominal Retractors

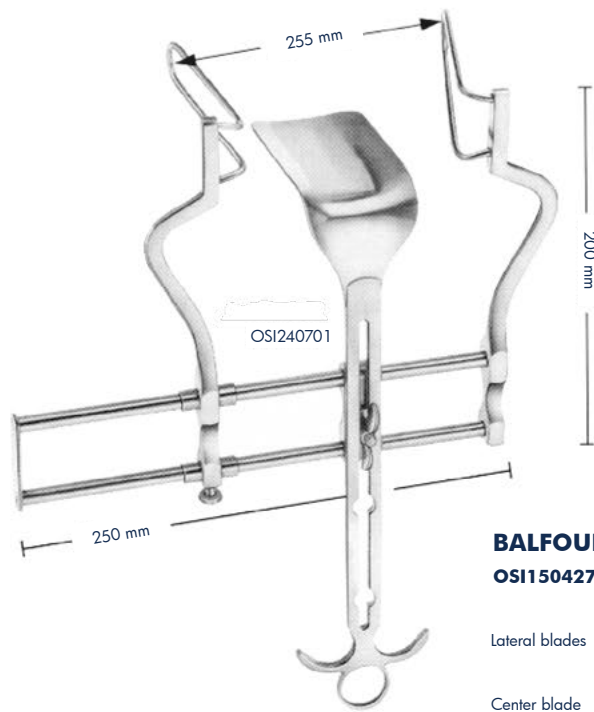

BALFOUR
OSI150427

Lateral blades 105 mm deep
OSI240701
 Center blade 107 x 59 mm



OSI150429

Center blade only
 54 x 80 mm



OSI150912

Center blade, slotted
 for retropubic prostatectomy
 75 x 80 mm

Abdominal Retractors

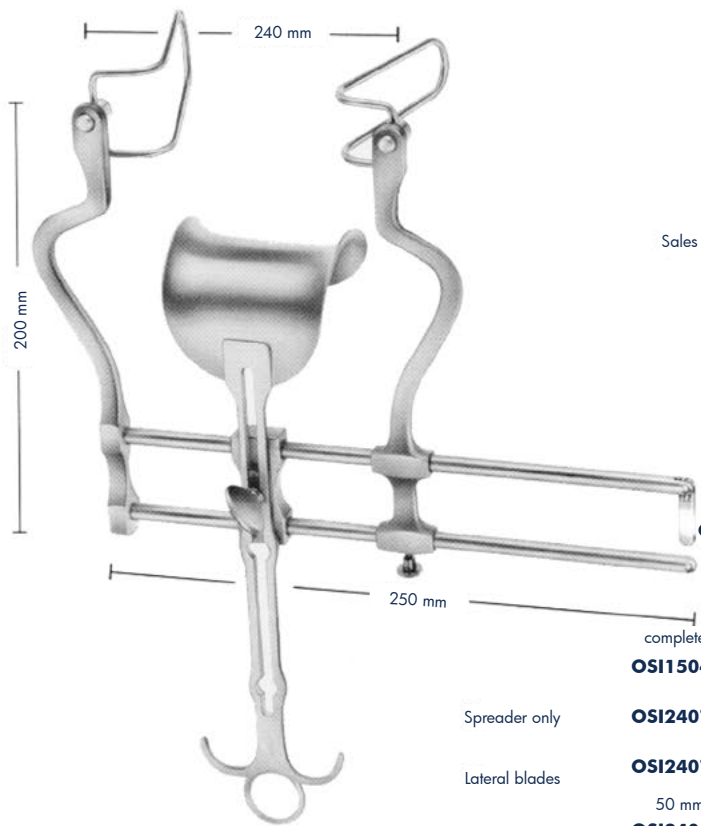

Lateral blades

OSI240702
50 mm deep

OSI150434
60 mm deep

OSI150435
75 mm deep

OSI240703
90 mm deep

Sales unit of blades: PR = pair

BALFOUR

OSI150433 -

	complete	complete	complete	complete
	OSI150433	OSI240704	OSI240705	OSI240706
Spreader only	OSI240707	OSI240707	OSI240707	OSI240707
Lateral blades	OSI240702	OSI150434	OSI150435	OSI240703
	50 mm	60 mm	75 mm	90 mm
Center blade	OSI240698	OSI240699	OSI240700	OSI240700
	47 x 80 mm	62 x 76 mm	80 x 80 mm	80 x 80 mm

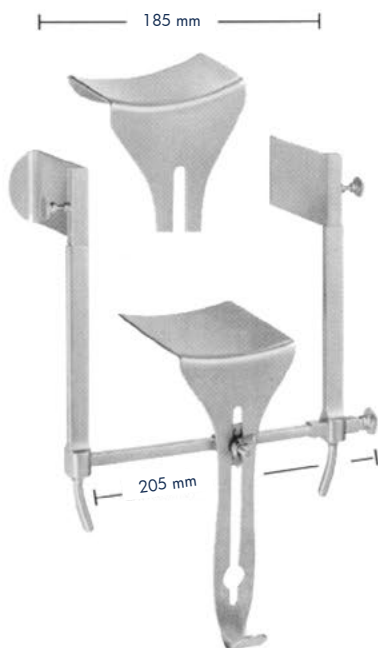

GOLIGHER

OSI150913

complete, includes:

- 1 Center blade 51 mm deep
- 1 Center blade 102 mm deep
- 1 Pair lateral blades 51 mm deep
- 1 Pair lateral blades 102 mm deep

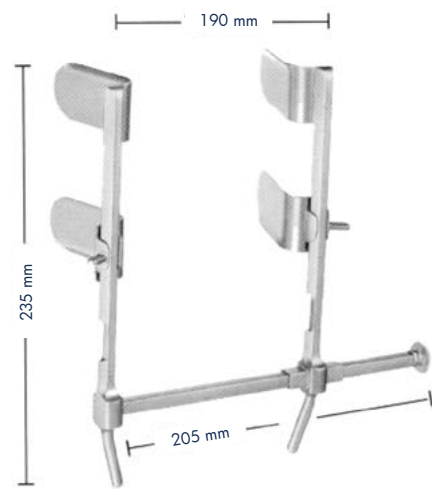

BERKELEY

OSI150914

complete, with 2 fixed and
2 movable blades 60 x 35 mm

Retraction System MÜNSTER - Parts of the System

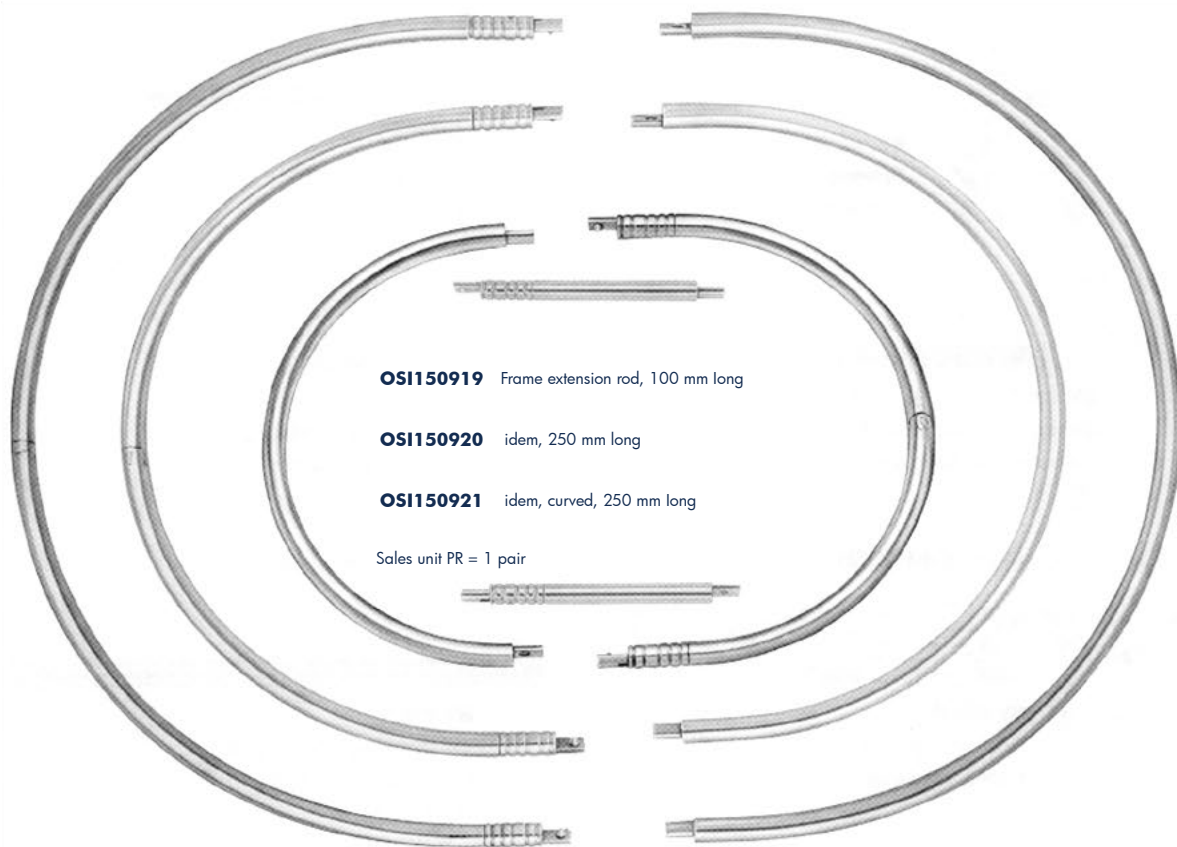

OSI150919 Frame extension rod, 100 mm long

OSI150920 idem, 250 mm long

OSI150921 idem, curved, 250 mm long

Sales unit PR = 1 pair

OSI150915

Abdominal frame I,
detachable,
238 x 180 mm

OSI150916

Abdominal frame II,
detachable,
328 x 270 mm

OSI150917

Abdominal frame III,
detachable,
408 x 350 mm

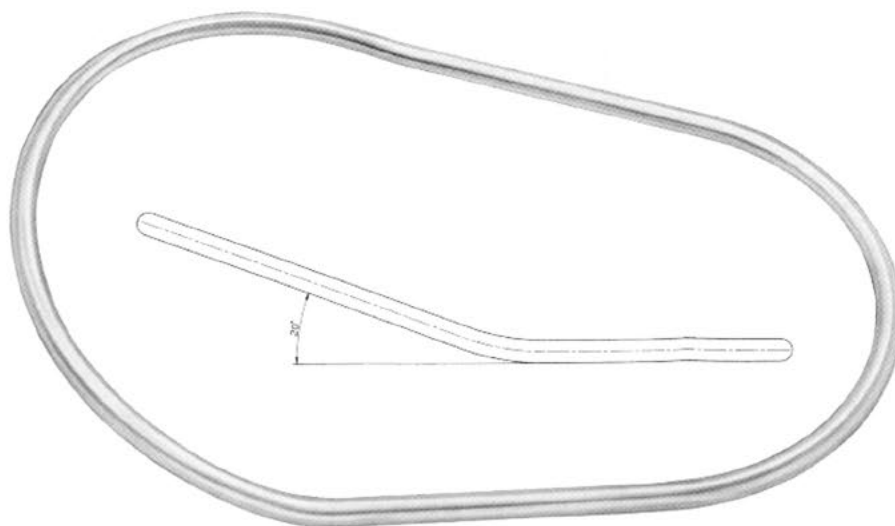

OSI150918

Vaginal frame,
20 ° angled,
270 x 200 mm,
not detachable

Retraction System MÜNSTER - Parts of the System



OSI150922

Connecting clamp



OSI150923

Notch rod
150 mm



OSI150924

Extension for notch rod 100 mm
100 mm



OSI150925

Notch rod end part 60 mm
60 mm

For use with ROCHARD frame



OSI150926

Rochard-Adapter



OSI150927

Extension rod, smooth
200 mm

OSI150918

Mounting frame for fastening to both sides of the lateral bars of the operating table, thus more stability is given, can be dismantled for sterilisation

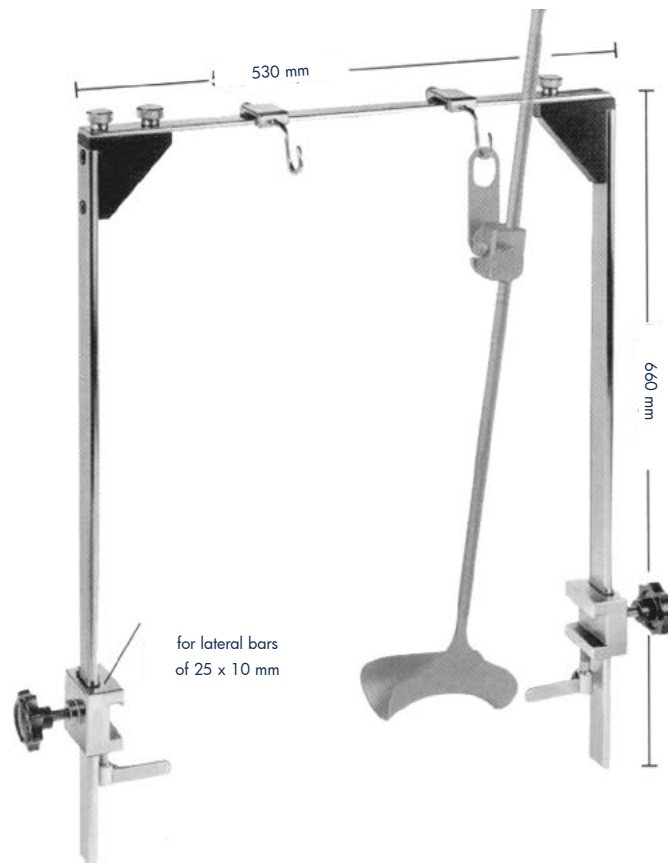

Retraction System MÜNSTER - Valves

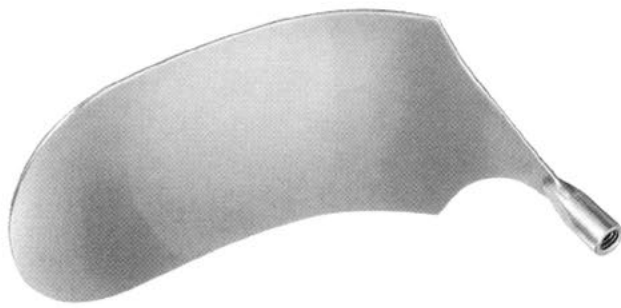

OSI150928 140 x 85 mm

Liver retractor



HARRINGTON

OSI150929 130 x 62 mm

Retractor



KELLY

OSI150930 140 x 40 mm

Retractor



DEAVER

OSI150931 85 x 25 mm

Retractor

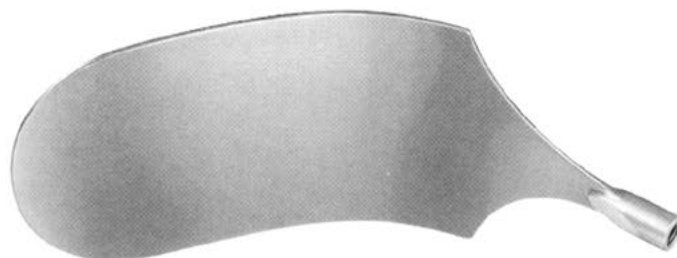

OSI150932 110 x 85 mm

Bladder spatula, 30° angled

Retraction System MÜNSTER - Valves



OSI150933 50x 90 mm
OSI150934 50 x 105 mm

Abdominal Retractor



KELLY

OSI150935 63 x 55 mm
OSI150936 70 x 63 mm

Abdominal Retractor



OSI150937 62 x 76 mm
OSI150938 80 x 80 mm

Abdominal Retractor



MIKULICZ
OSI150939 120 x 50 mm
OSI150940 155 x 50 mm

Abdominal Retractor



wide
OSI150941 30 mm
OSI150942 40 mm
OSI150943 50 mm
OSI150944 85 mm
Abdominal spatula, malleable
220 mm

Retraction System MÜNSTER - Valves



OSI150945 25 x 115 mm

Vaginal Retractor, posterior blade



OSI150946 25 x 75 mm

Vaginal Retractor, lateral blade



OSI150947

Adapter for ball snap closure valves

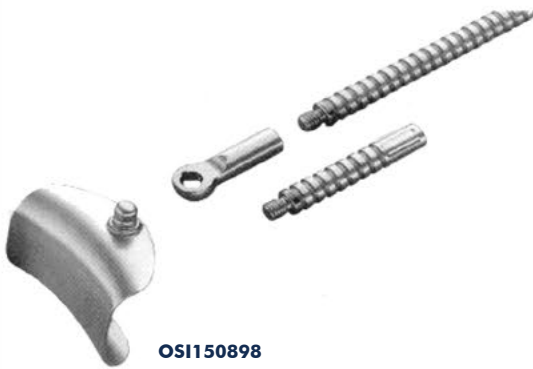

OSI150898



OSI150948 130 x 73 mm

Y-Bladder Retractor



OSI150898 37 x 63 mm

OSI150899 37 x 80 mm

OSI150900 37 x 98 mm

Abdominal valve



OSI150902 48 x 59 mm

OSI150903 58 x 80 mm

OSI150904 77 x 84 mm

Abdominal valve



OSI150905 59 x 80 mm

Abdominal valve

Sales unit: PR = 1 Pair

Retraction System MÜNSTER - Fixation and Storage

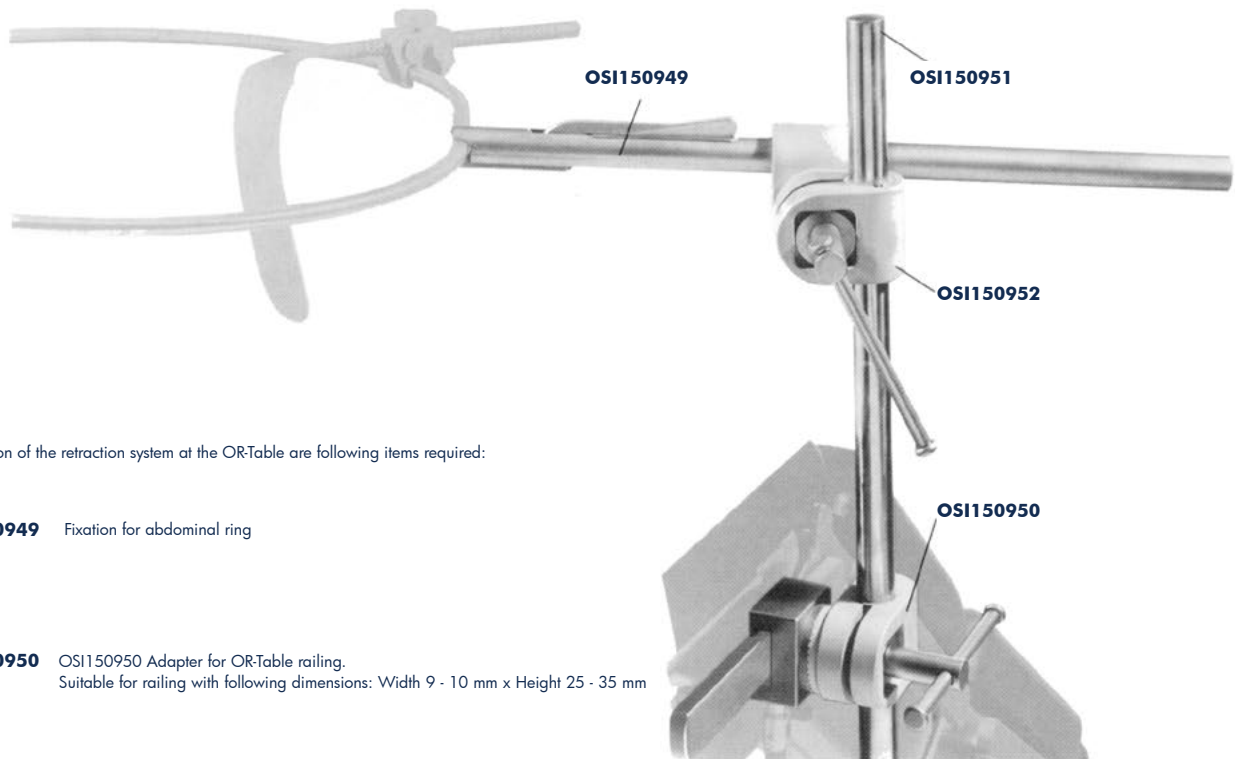

For fixation of the retraction system at the OR-Table are following items required:

OSI150949 Fixation for abdominal ring

OSI150950 OSI150950 Adapter for OR-Table railing.
Suitable for railing with following dimensions: Width 9 - 10 mm x Height 25 - 35 mm

OSI150951 Rod for connection of **OSI150950** and **OSI150952**

OSI150952 Fixation element for connection of **OSI150949** and **OSI150951**

Abdominal Retractors

Abdominal retractors for new-born and children

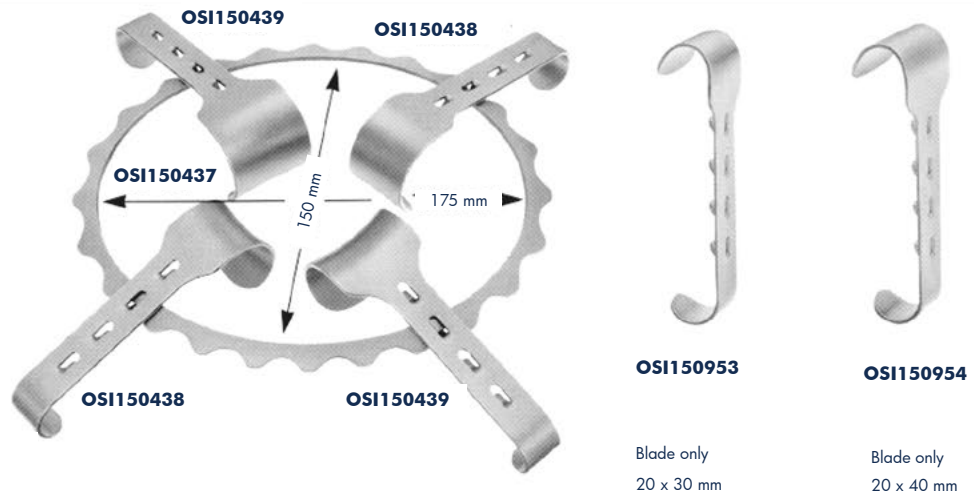

DENIS-BROWNE

OSI150436 complete

consisting of:

- frame 175 x 150 mm
- blades only 40 x 30 mm
- blades only 40 x 40 mm

Abdominal Retractor well suitable for gynaecologists

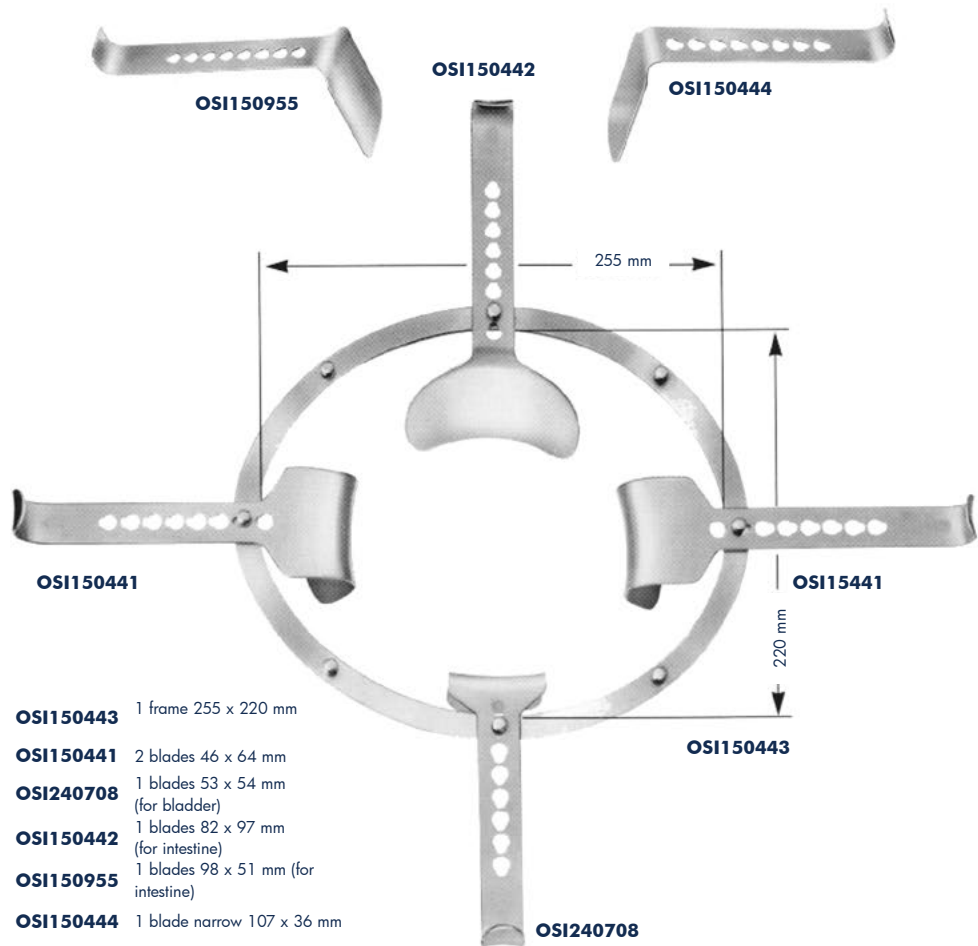

SEMM

OSI150440

consisting of:

- OSI150443** 1 frame 255 x 220 mm
- OSI150441** 2 blades 46 x 64 mm
- OSI240708** 1 blades 53 x 54 mm (for bladder)
- OSI150442** 1 blades 82 x 97 mm (for intestine)
- OSI150955** 1 blades 98 x 51 mm (for intestine)
- OSI150444** 1 blade narrow 107 x 36 mm

Abdominal Retractors

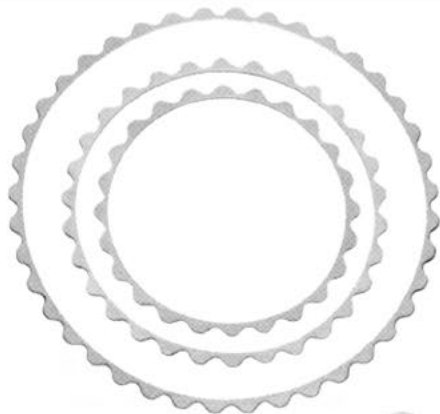

TURNER-WARWICK

- diam.
- OSI150956** 180 mm
- OSI150957** 230 mm
- OSI150958** 305 mm

Retractor frame, round



TURNER-WARWICK

OSI150960 457 x 330 mm

Retractor frame, oval

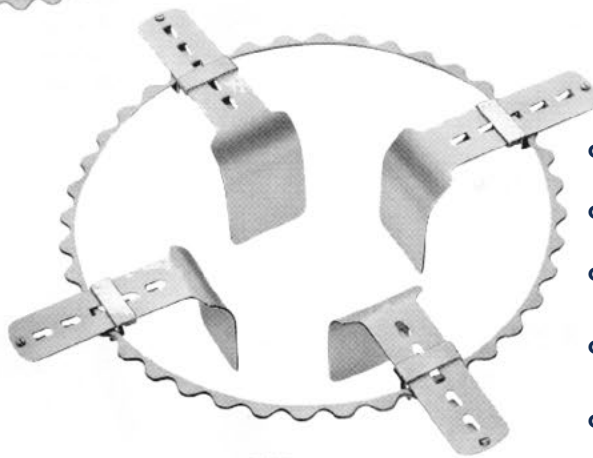

TURNER-WARWICK

OSI150959

Abdominal retractor, complete

Consisting of:

OSI150956 **OSI150958**

frames; 1 of each

OSI150961 **OSI150964**

Retractor blades copper, 2 of each

OSI150965 **OSI150966**

2 Abdominal retractors of each

OSI150967 **OSI150968**

2 Abdominal retractors of each

OSI150969

Retractor blade single hook



OSI150961

copper

76 x 19 mm

OSI150962

copper

102 x 38 mm

OSI150963

copper

89 x 57 mm

OSI150964

copper

114 x 57 mm

OSI150965

51 x 38 mm

OSI150966

76 x 60 mm

OSI150967

89 x 60 mm

OSI150968

114 x 60 mm

OSI150969

hook 13 mm

Abdominal Retractors

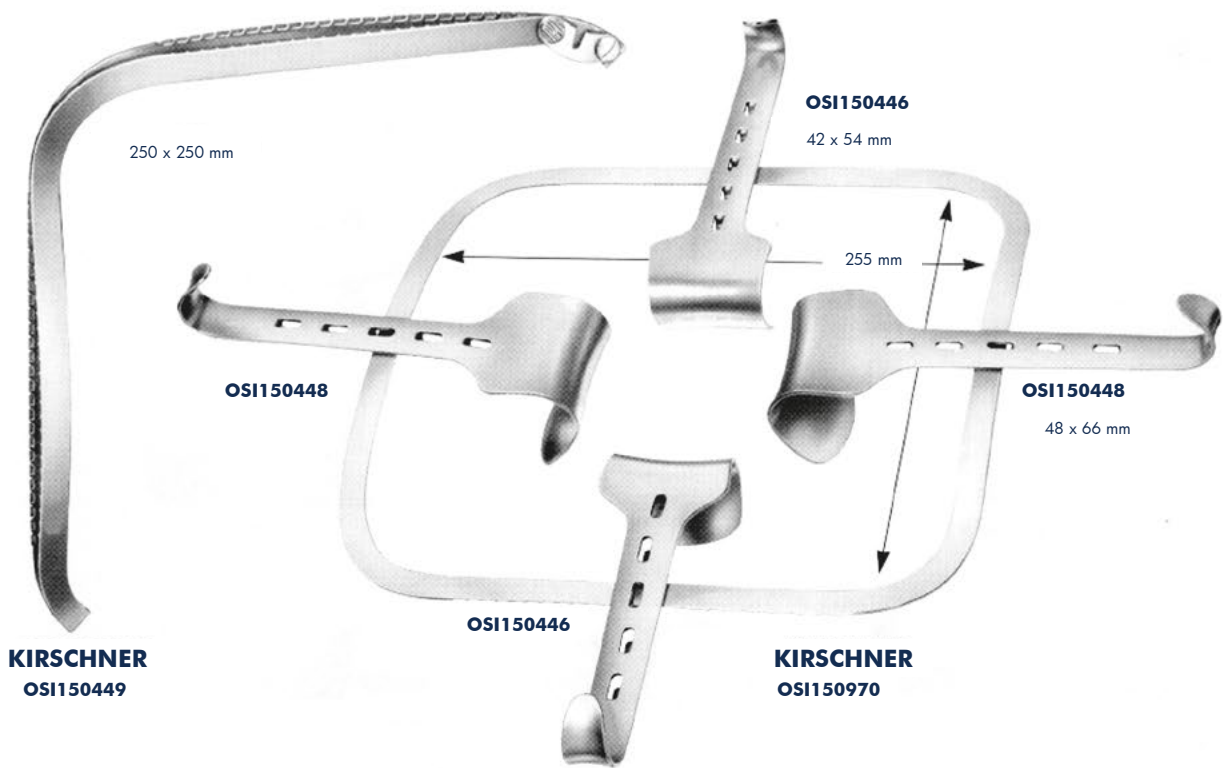

KIRSCHNER
OSI150449

KIRSCHNER
OSI150970

2 blades of each OSI150448 and OSI150446

2 blades of each OSI150448 and OSI150446

OSI150971

275 x 355 mm

Frame only, over-sized

OSI150972

295 x 275 mm

Additional valves for corpulent persons

Frame only



KIRSCHNER
OSI150973
64 x 80 mm



KIRSCHNER-BALFOUR
OSI150974
80 x 82 mm



KIRSCHNER
OSI150975 90 x 69 mm
OSI150976 92 x 95 mm
OSI150977 78 x 58 mm



KIRSCHNER
OSI150978 108 x 42 mm
OSI150979 91 x 55 mm
OSI150980 121 x 55 mm

Abdominal Retractors

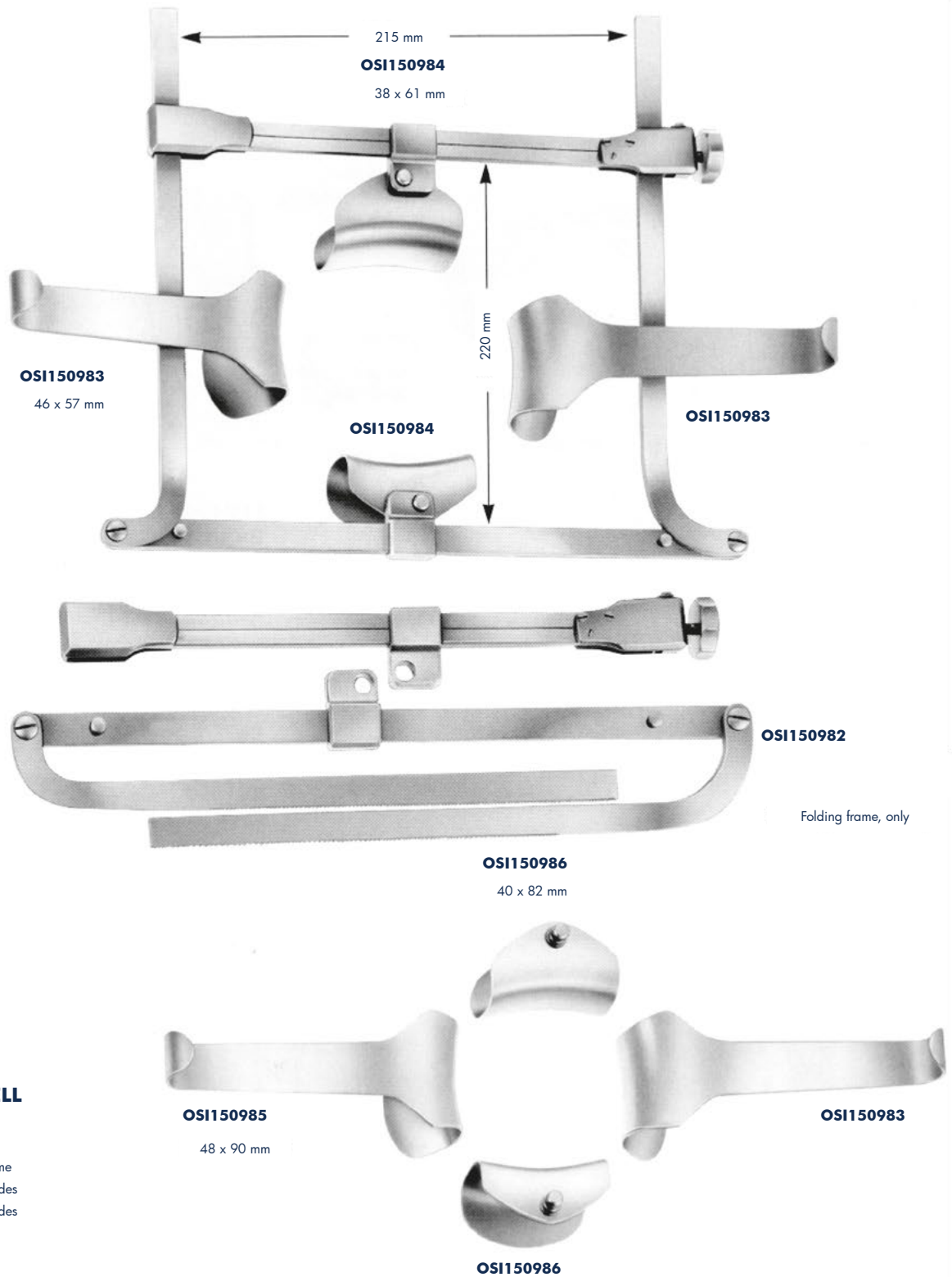

FRANZ MODELL

OSI150981

consisting of:

- 1 **OSI150982** frame
- 2 **OSI150983** blades
- 2 **OSI150984** blades

OSI240709

consisting of:

- 1 **OSI150982** frame
- 2 **OSI150983** blades
- 2 **OSI150984** blades
- 2 **OSI150985** blades
- 2 **OSI150986** blades

Bladder Retractors



MILLIN
OSI150987
 Bladder retractor
 Complete

- OSI150988** Spreader only
- OSI150989** Blades 57 x 25 mm
- OSI150990** Blades 82 x 25 mm
- OSI150991** Center Blade 105 x 45 mm



LEGUEU
OSI150992

Bladder retractor center blade
 80 x 31 mm

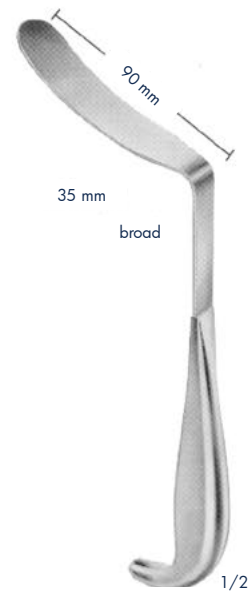

LEGUEU
OSI230296

Bladder spatula
 260 mm

Poplitea Retractors



OSI150993

Poplitea retractor, complete

consisting of:

OSI150994 Retractor, only

OSI150995 Blades (pair)



OSI150995

Blades (pair), only
consisting of:
blades 60 x 50 mm, blunt
blades 40 x 35 mm, semi-sharp

Intestinal- and Tissue Grasping Forceps



CHAPUT
OSI140161

2 x 3 teeth, sharp
125 mm



TUFFIER
OSI140162

5 x 6 teeth, sharp 125 mm

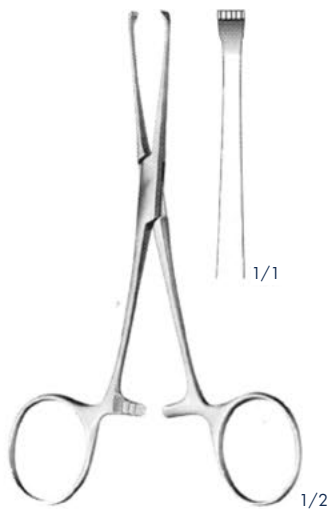

BABY-ALLIS
OSI230101

4 x 5 teeth 130 mm

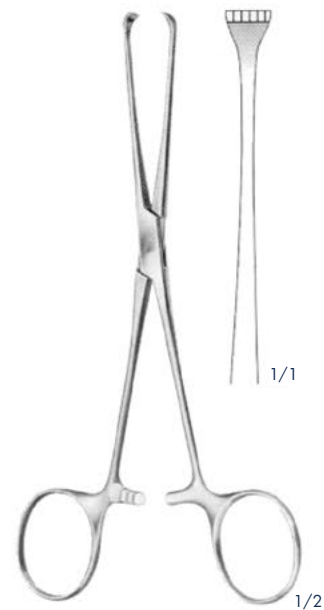

BOYS-ALLIS
OSI230111

5 x 6 teeth, sharp 155 mm

Intestinal- and Tissue Grasping Forceps

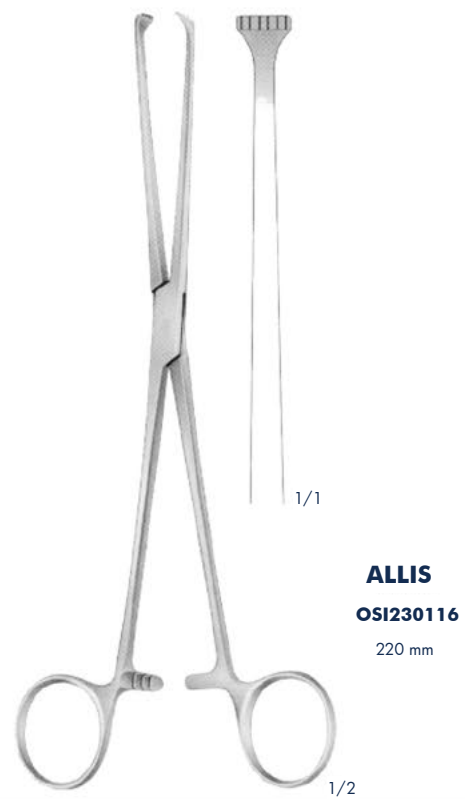
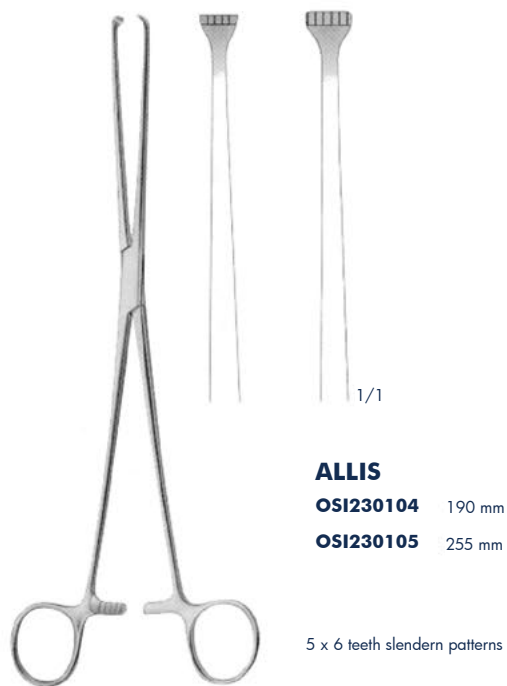
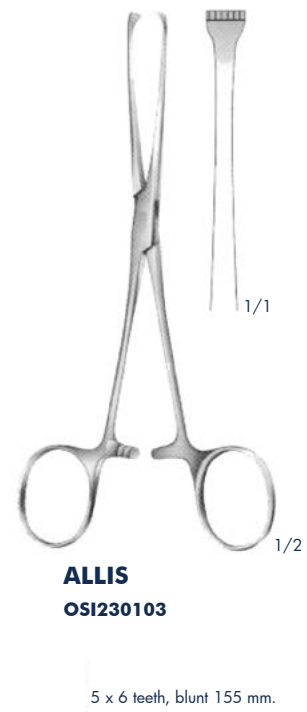

Organ- and Tissue Grasping Forceps

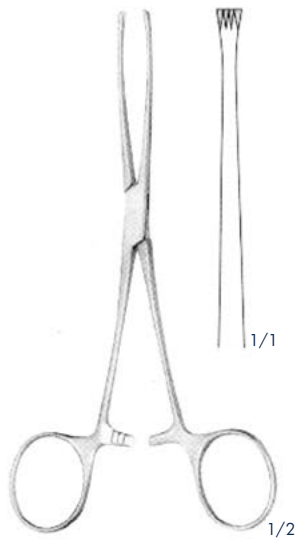

JUDD-ALLIS

OS1230114

3 x 4 teeth

155 mm

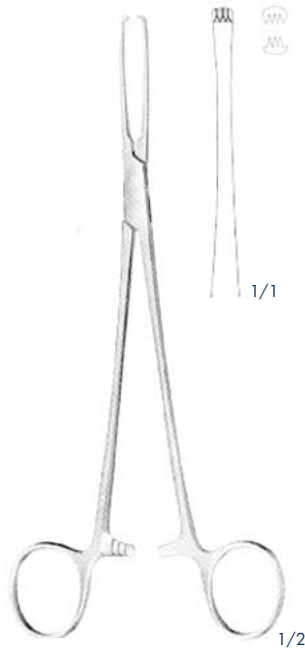

JUDD-ALLIS

OS1230318

3 x 4 teeth

195 mm



ALLIS-THOMS

OS1230117

6 x 7 teeth

200 mm

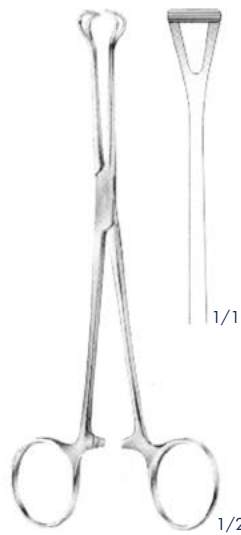

BABCOCK

OS1230123

155 mm



BABCOCK

OS1230124 170 mm

OS1230125 215 mm

OS1230319 200 mm

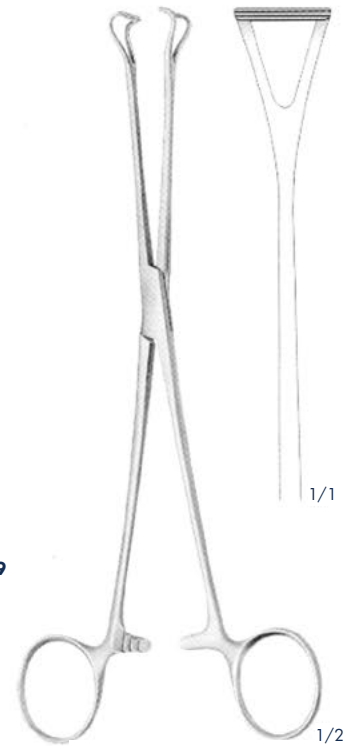

BABCOCK

OS1200502

220 mm

TUBB

OS1180

230 mm

Set, consi

45°

Ø 4,5 mm

Intestinal Grasping Forceps

S
285

isting of:

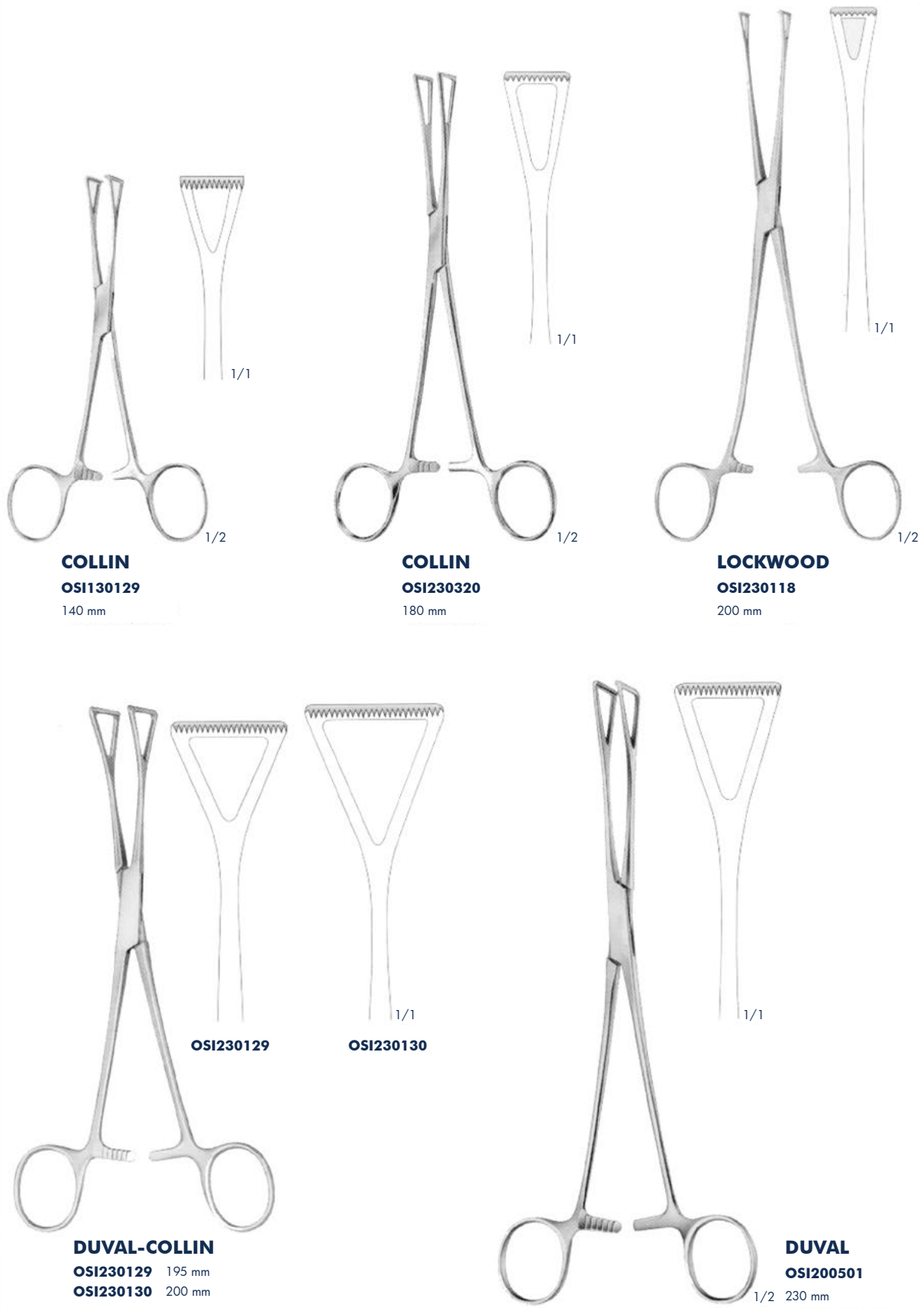

COLLIN
OSI130129
140 mm

COLLIN
OSI230320
180 mm

LOCKWOOD
OSI230118
200 mm

DUVAL-COLLIN
OSI230129 195 mm
OSI230130 200 mm

DUVAL
OSI200501
1/2 230 mm

Organ-, and Tissue Grasping Forceps and Dissecting Forceps



OSI130354 130 mm
OSI140171 155 mm
OSI140172 195 mm

LANE
OSI130354 - OSI140172

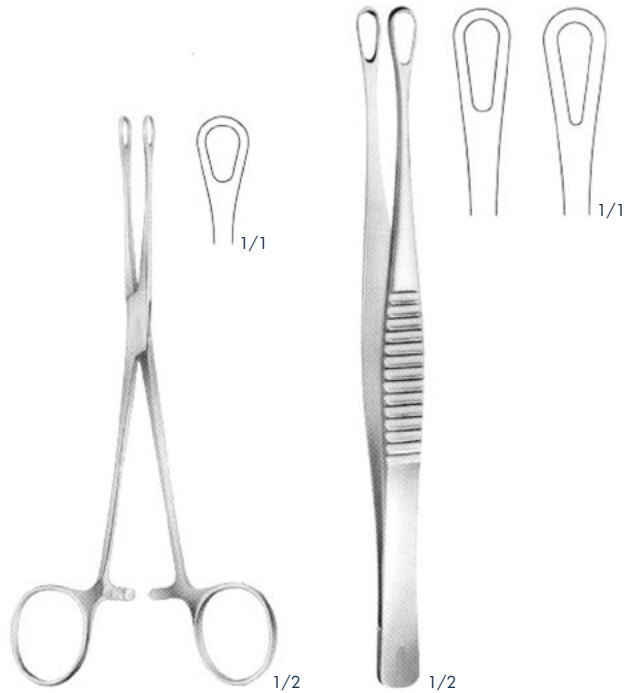

WILLIAMS
OSI230119
 160 mm

DENIS BROWNE
OSI230321
 190 mm

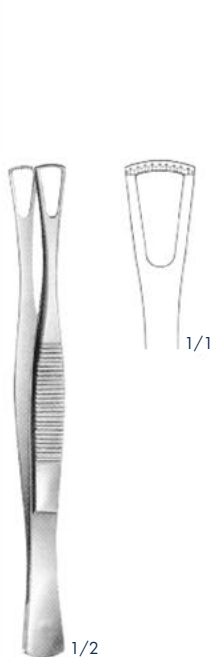

DUVAL
OSI120207
 140 mm



WANGENSTEEN
OSI120367 150 mm
OSI120368 230 mm

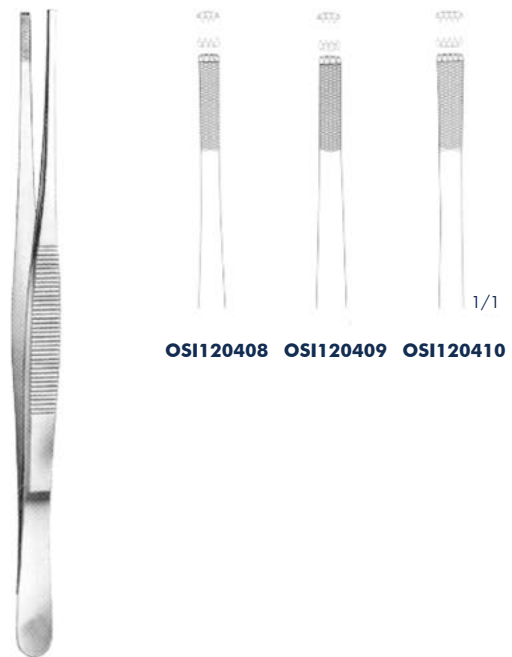

STILLE-BARRAYA
OSI120408 180 mm
OSI120409 200 mm
OSI120410 250 mm

Organ-, and Tissue Grasping Forceps and Dissecting Forceps

ATRAUMATIC



ALLIS

- OSI230106** 155 mm
- OSI230107** 200 mm
- OSI230322** 220 mm
- OSI230108** 255 mm
- OSI230109** 300 mm

BABCOCK

- OSI230127** 160 mm
- OSI230128** 215 mm



COLLIN

- OSI230323 - OSI230324**

Ultra- Light-Forceps, Dissecting Forceps

ATRAUMATIC

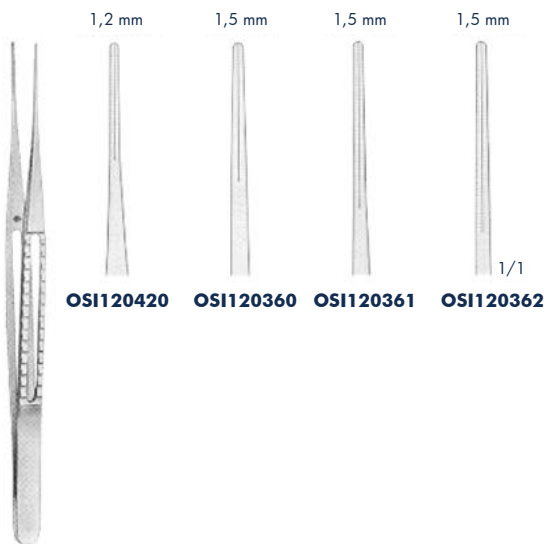

- OSI120420** 150 mm
- OSI120360** 200 mm
- OSI120361** 240 mm
- OSI120362** 300 mm



DE BAKEY

- OSI200130** 150 mm
- OSI200131** 200 mm
- OSI200132** 240 mm
- OSI200133** 300 mm

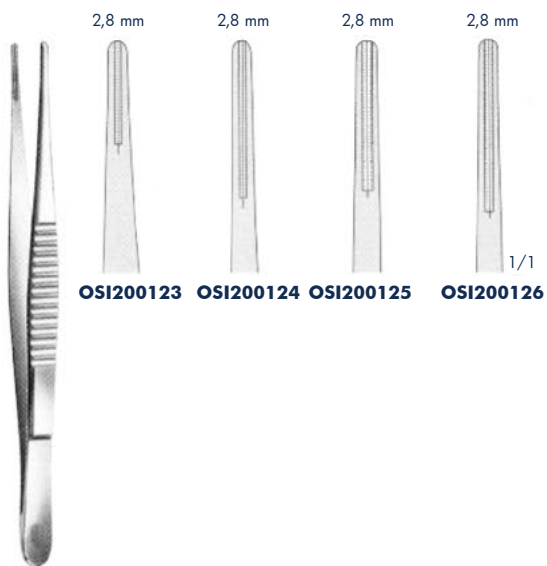

DE BAKEY

- OSI200123** 150 mm
- OSI200124** 200 mm
- OSI200125** 240 mm
- OSI200126** 300 mm



DE BAKEY

- OSI200138** 200 mm
- OSI200139** 240 mm
- OSI200140** 300 mm
- OSI200141** 350 mm

Intestinal Clamps for Children



BAINBRIDGE
OSI230325 - OSI230326
 155 mm



ALLEN
OSI230327
 155 mm

ATRAUMATIC



BABY-KOCHER
OSI230328 - OSI230329
 very elastic blades
 130 mm



BABY-KOCHER
 with soft and elastic blades
 130 mm

Intestinal Clamps, soft elastic

ATRAUMATIC



ATRAUMATIC



Intestinal Clamps, soft elastic

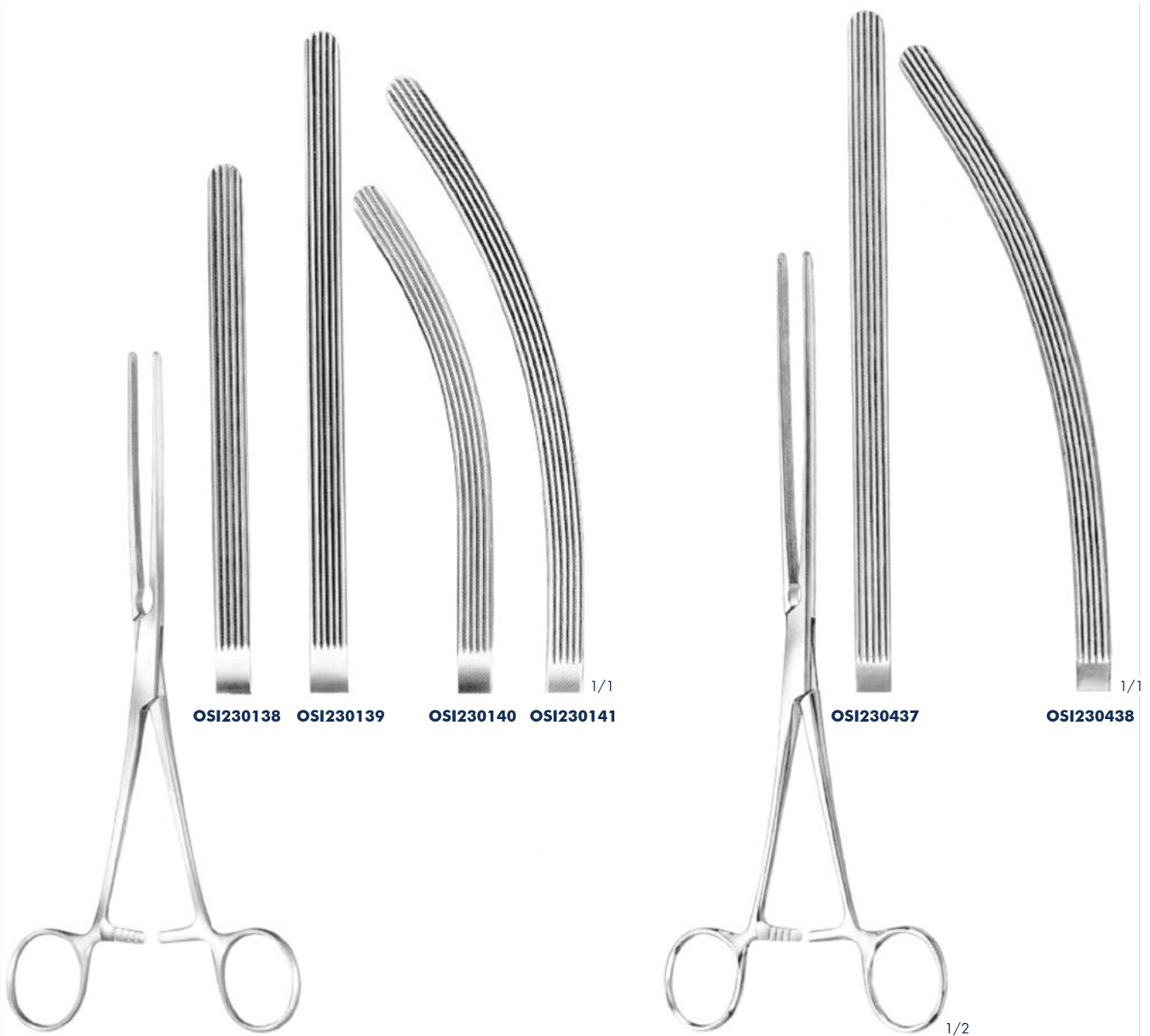

KOCHER

OSI230138 - OSI230140 210 mm

OSI230139 - OSI230141 230 mm

with soft and elastic blades

DOYEN

OSI230437 - OSI230438

with soft and elastic blades

240 mm

Intestinal Clamps, soft elastic

ATRAUMATIC



OSI230133

OSI230135 1/1

DOYEN
OSI230133 - OSI230135
with soft and elastic blades
235 mm



OSI230175

OSI230179 1/1

DOYEN
OSI230175 - OSI230179
with soft and elastic blades
230 mm

TUBB
OSI180
230 mm
Set, const
45°
Ø 4,5 mm

Intestinal Clamps, soft elastic

S
285

isting of:

m

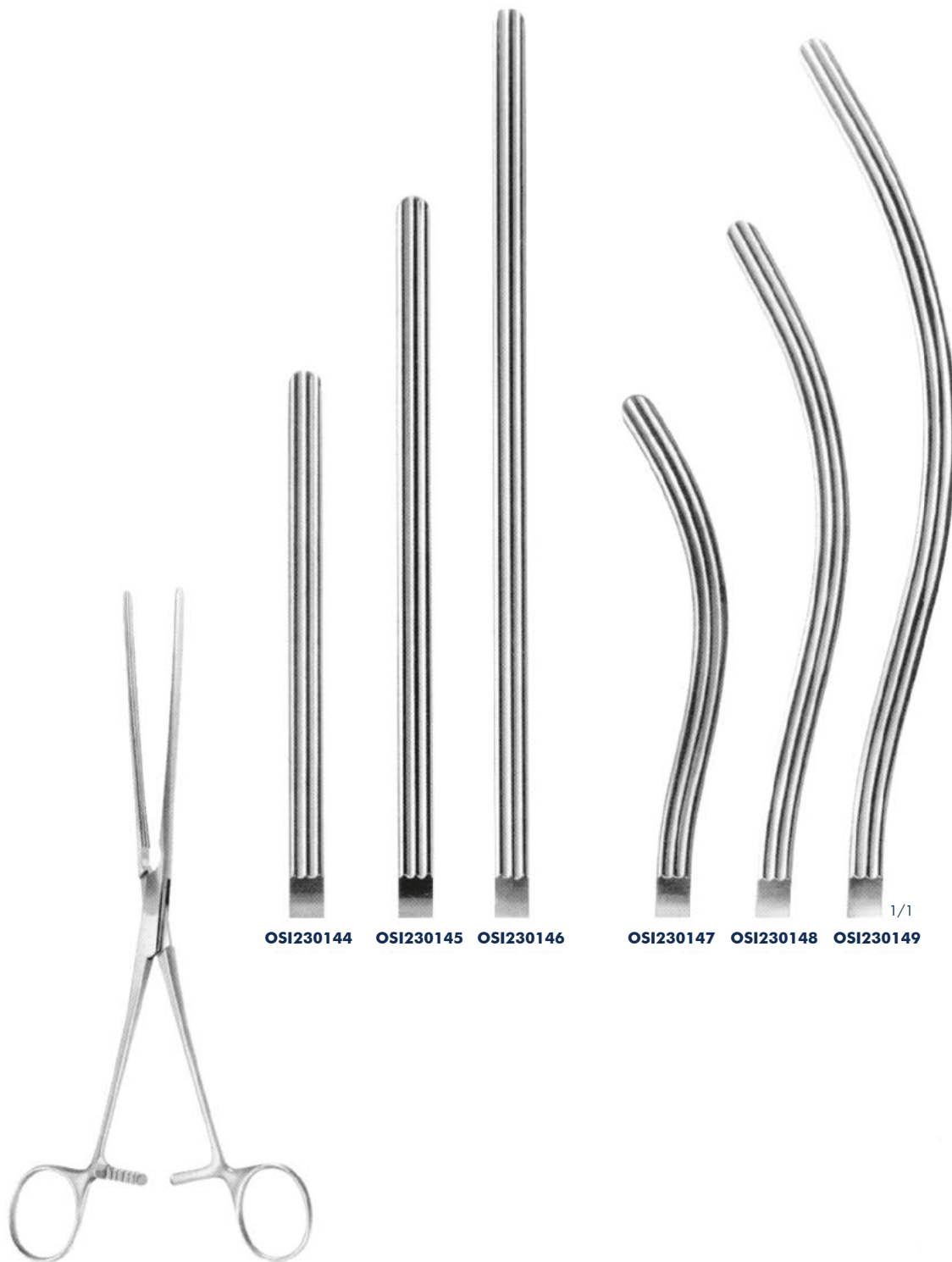

OSI230144 OSI230145 OSI230146 OSI230147 OSI230148 OSI230149 1/1

KOCHER

OSI230144 - OSI230147 220 mm

OSI230145 - OSI230148 250 mm

OSI230146 - OSI230149 280 mm

with very soft and elastic blades

Intestinal Clamps, soft elastic

ATRAUMATIC

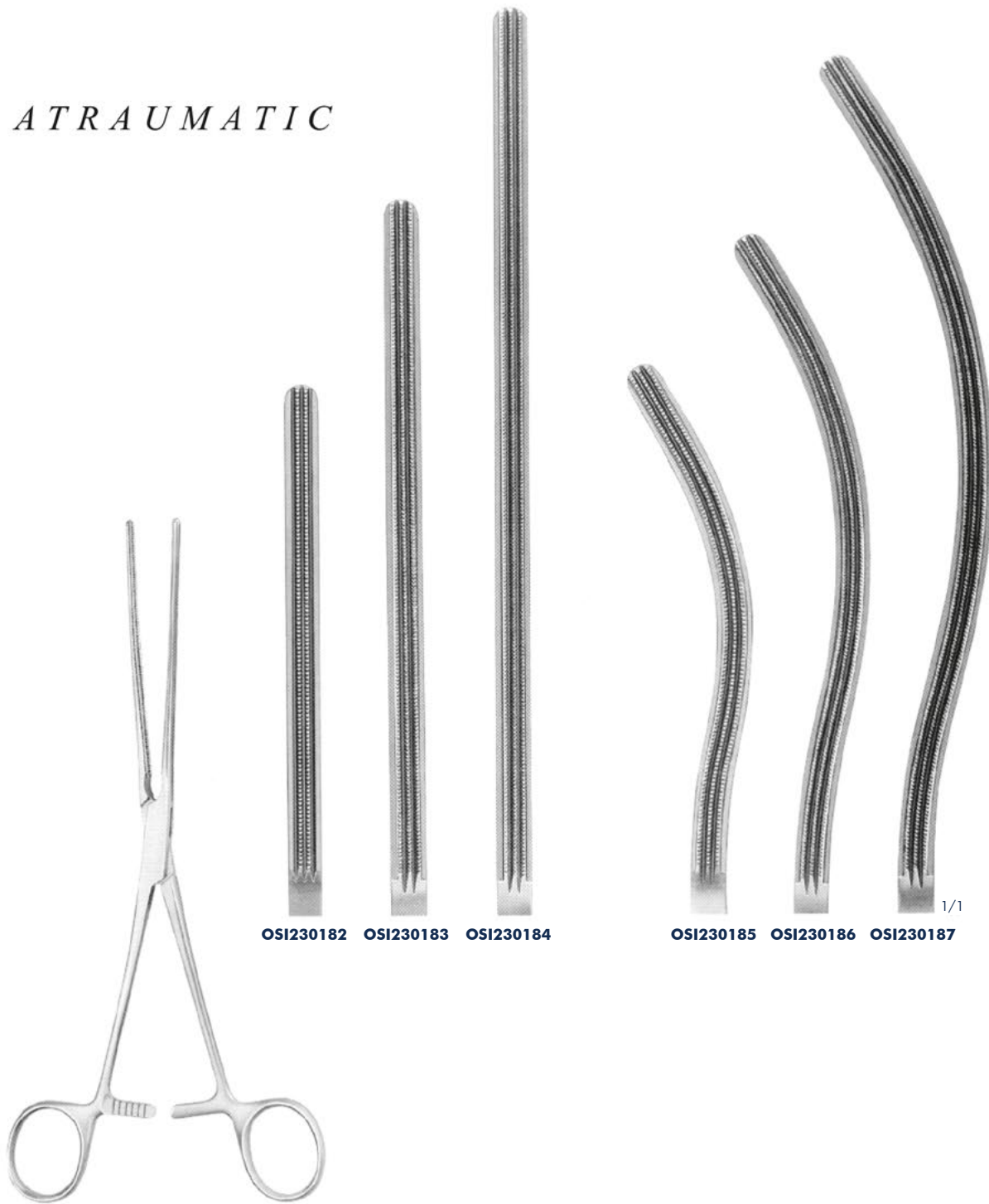

OSI230182 **OSI230183** **OSI230184**

OSI230185 **OSI230186** **OSI230187**

1/1

KOCHER

OSI230182 - OSI230185 220 mm

OSI230183 - OSI230186 250 mm

OSI230184 - OSI230187 280 mm

with very soft and elastic blades

TUBB
OSI180
 230 mm
 Set, consi
 45°
 Ø 4,5 mm

Intestinal Clamps

S
285

isting of:

m

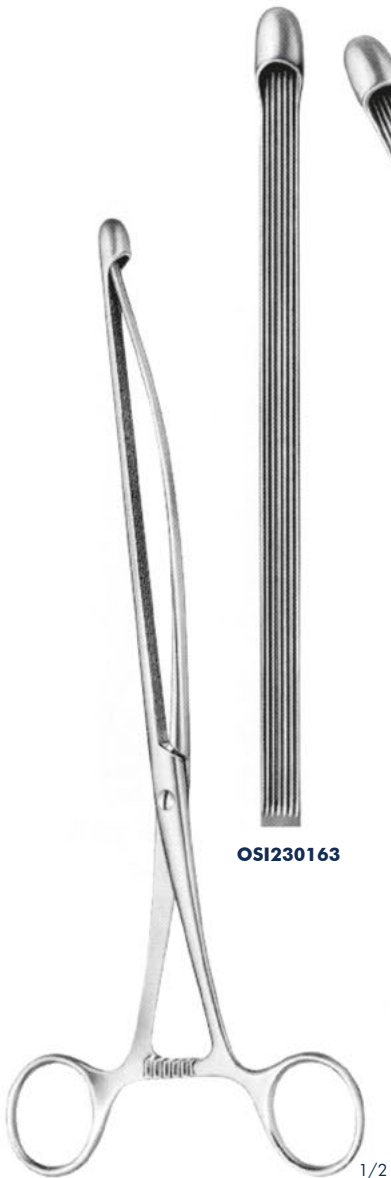

OSI230163

OSI230164

NUSSBAUM
OSI230163 - OSI230164
with soft and elastic blades
250 mm

1/2

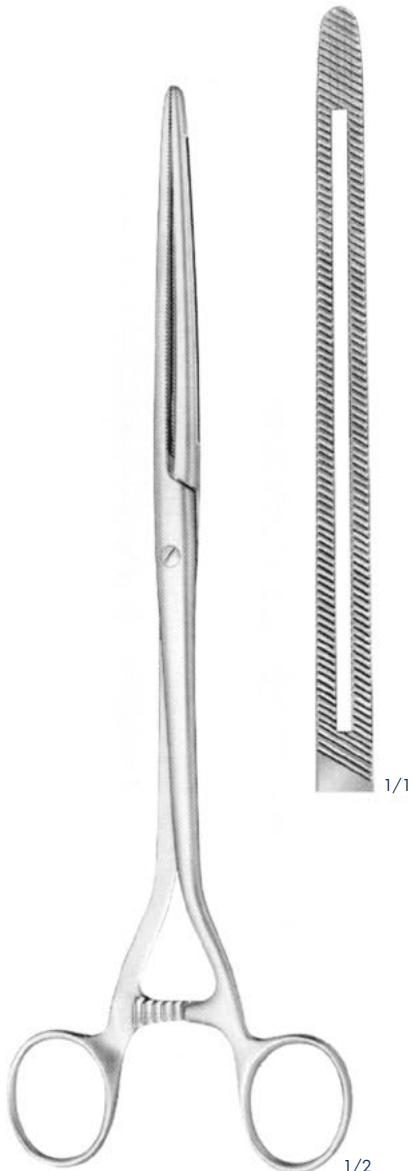

1/1

MOYNIHAN
OSI230439
280 mm

1/2

Intestinal Clamps



LANG - STEVENSON
OSI230440
200 mm



SCHOEMAKER
OSI230441-OSI230442
Colectomy clamp

OSI230441
170 mm

OSI230442
200 mm

Intestinal Clamps

ATRAUMATIC

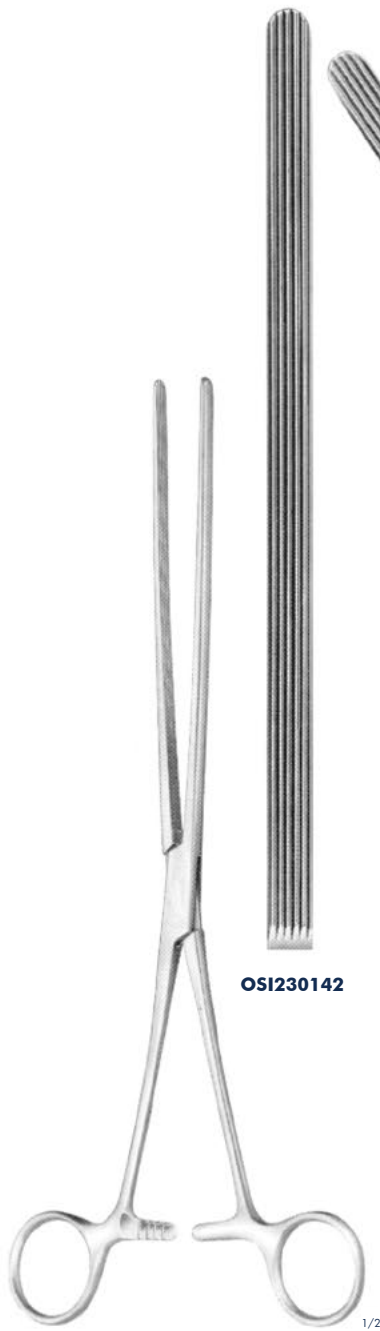

OSI230142

OSI230143

1/2

MAYO-ROBSON

OSI230142-OSI230143

250 mm
hard elastic

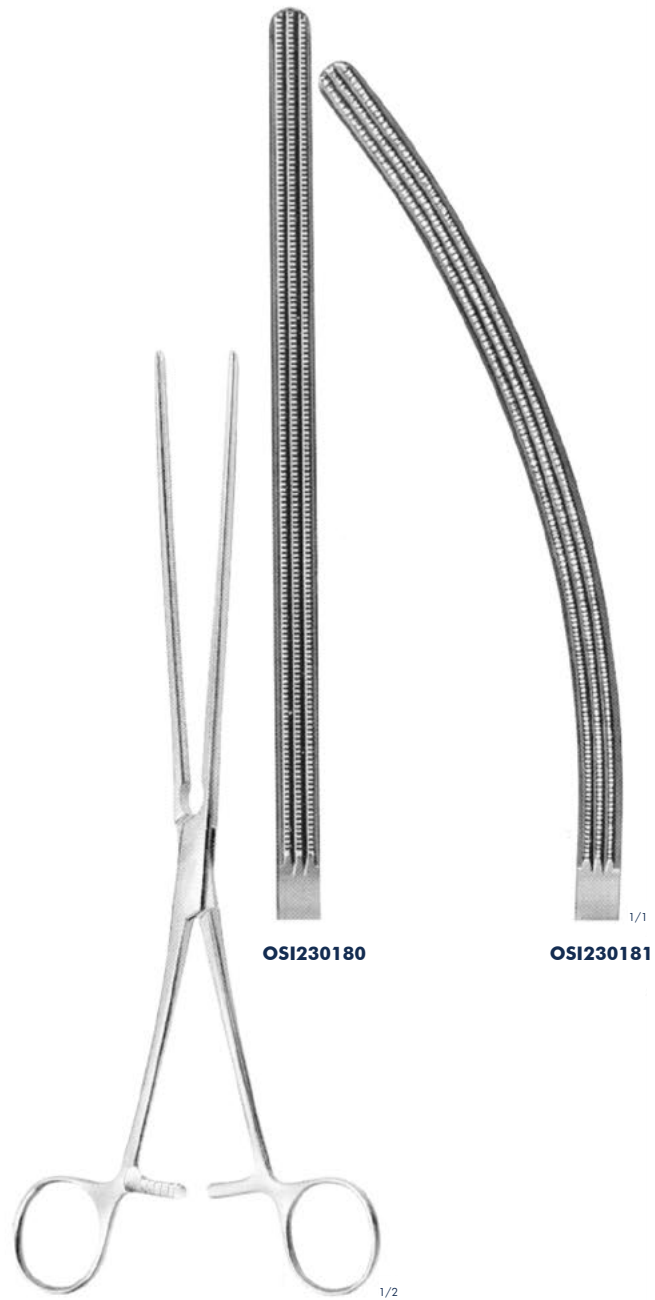

OSI230180

OSI230181

1/2

MAYO-ROBSON

OSI230180-OSI230181

250 mm

Gastro-Intestinal Forceps, twin

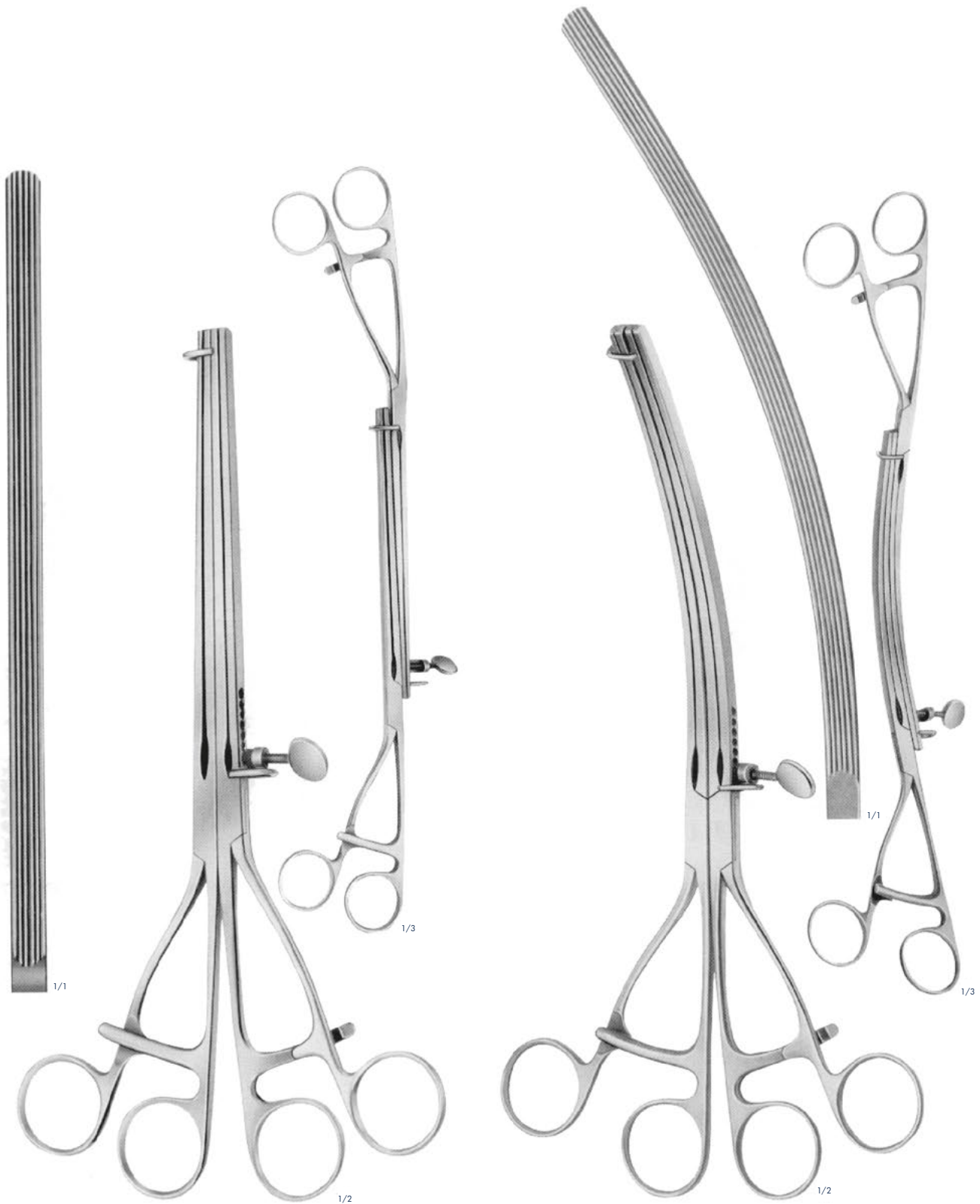

LANE
OS1230443
310 mm

LANE
OS1230444
310 mm

Gastro-Intestinal Forceps, twin

ATRAUMATIC

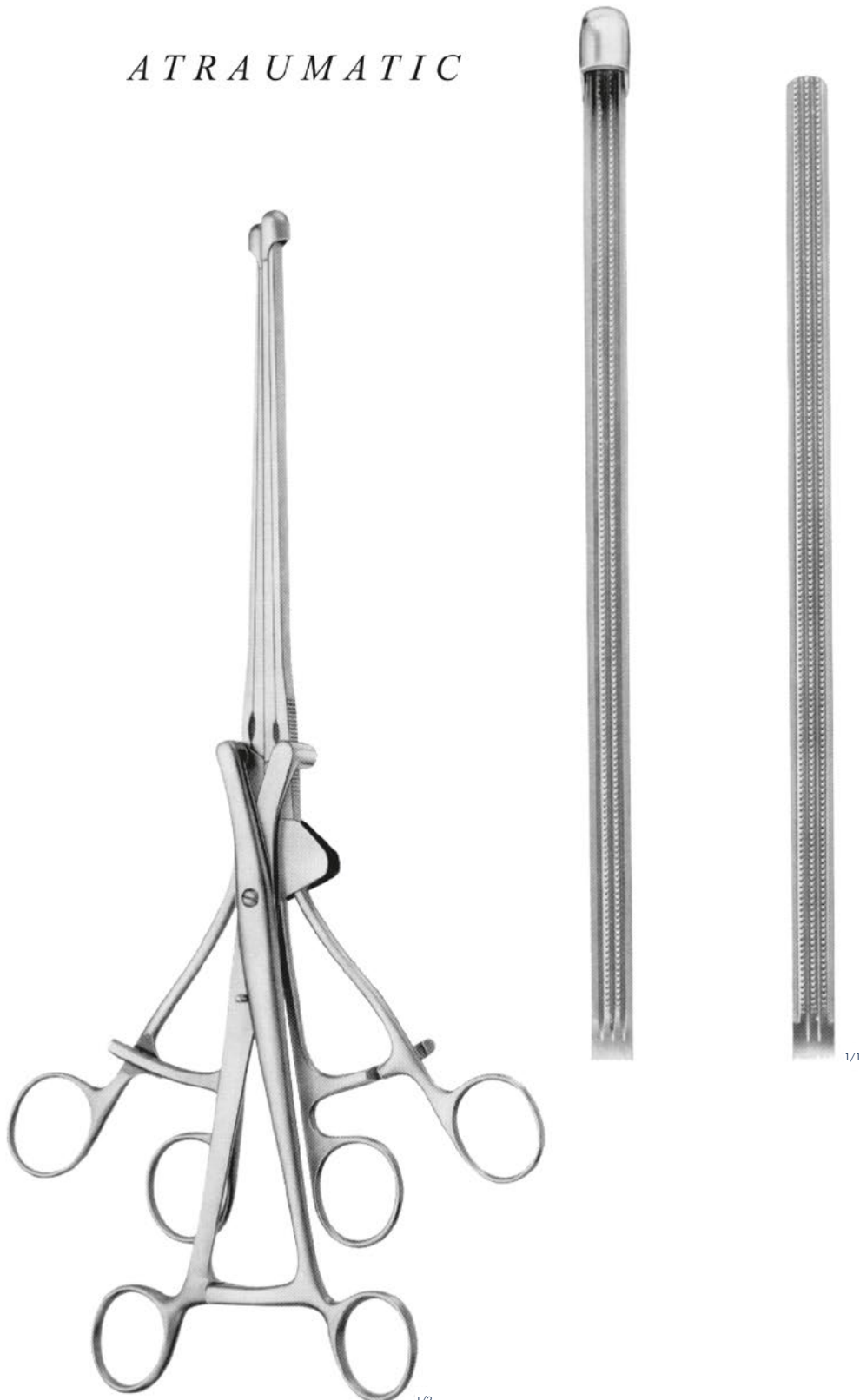

HABERER
OS1230445
360 mm

Stomach Clamps



SCUDDER
OSI230188
330 mm



OSI230188



KLEINSCHMIDT
OSI230446
Spur crushers and
Appendectomy clamps
130 mm



BENSON
OSI230447
155 mm
Pylorus spreader

Intestinal and Pylorus Clamps



PAYR
OSI230448
 Intestinal clamp
 light pattern,
 for children
 180 mm

PAYR
OSI230449
 200 mm

PAYR
OSI230450
 275 mm

PAYR
OSI230451
 315 mm
 Pylorus clamp

Anastomosis Clamps

ATRAUMATIC



DE MARTEL-WOLFSON
OSI230602 100 mm
OSI230165 120 mm

Anastomosis clamps,
 set of 3 pieces



KERSTING
OSI230452 70 mm

Colostomy clamps



1/1



Clamp holder with set of clamps



OSI230166 80 mm
OSI230167 225 mm
 Clamp holder
 for



1/3

DE MARTEL-WOLFSON
OSI230453
 Closing forceps
 for
 250 mm

Anastomosis Forceps

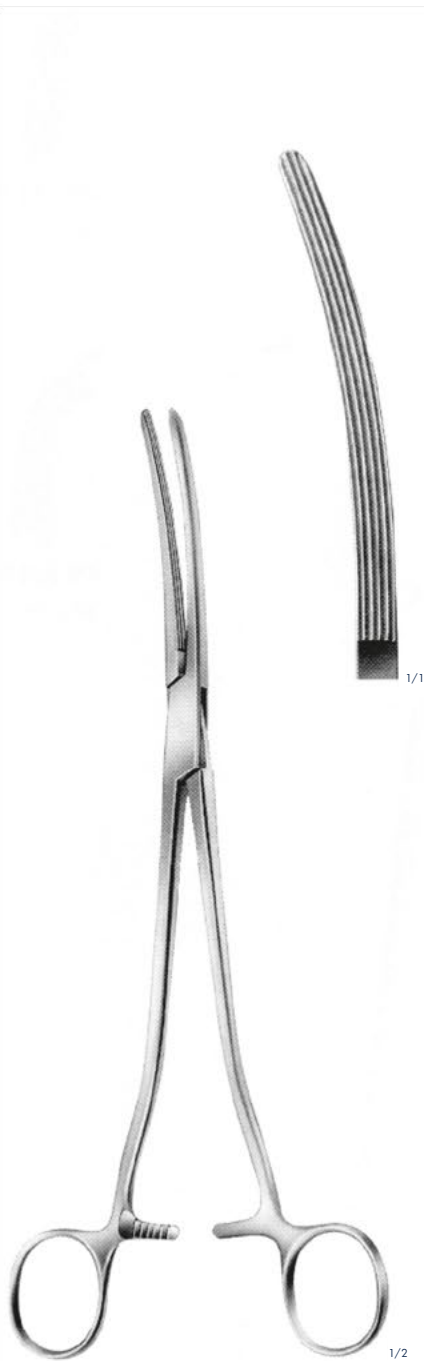

PARKER-KERR

OSI230454

Anastomosis forceps for colon resections

250 mm



DICK

OSI230455 255 mm

OSI230456 265 mm

OSI230457 275 mm

Pressure clamps

Sigmoid Anastomosis Forceps



BRUNNER
OSI230131
245 mm

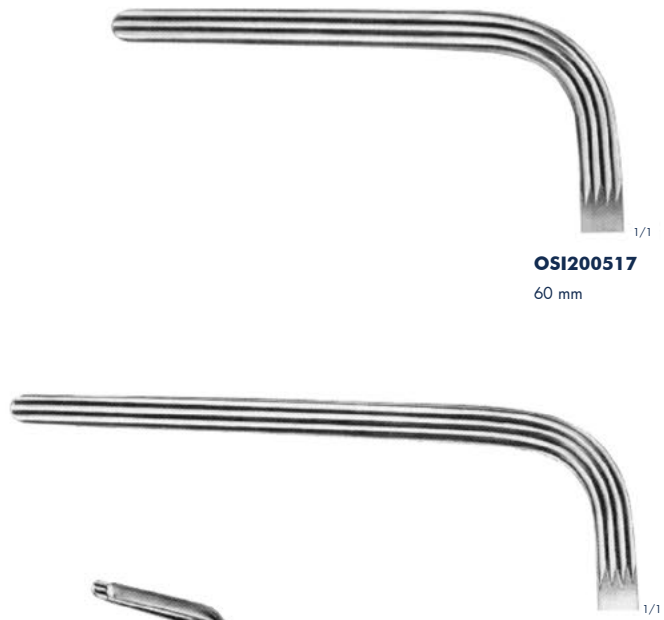

OSI200517
60 mm

OSI200518
80 mm



OSI200517-OSI200518
230 mm

Sigmoid Anastomosis Forceps

ATRAUMATIC



FINCH
OSI230458
Excision clamp
230 mm

LLOYD-DAVIS
OSI230459
315 mm

Sigmoid Anastomosis Forceps

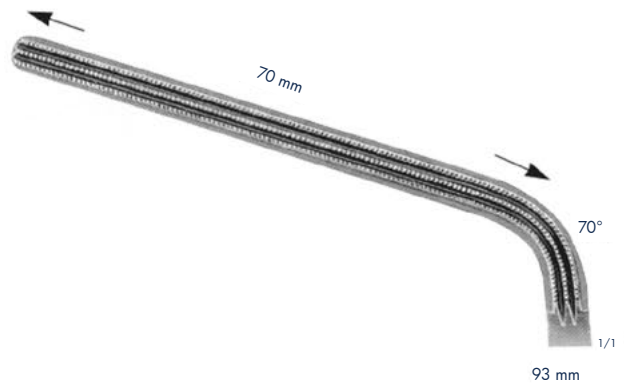
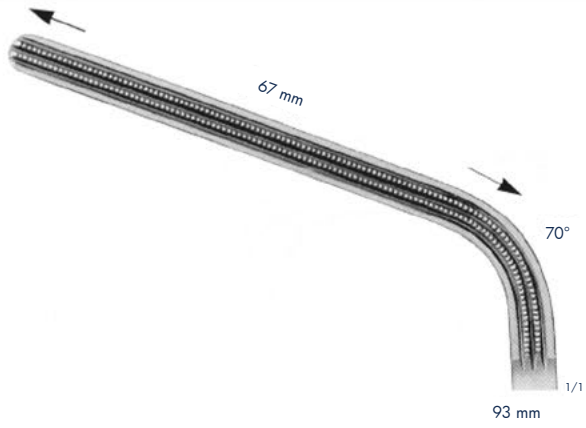

MORRIS
OSI200420
175 mm



DE BAKEY
(MORRIS modif.)
OSI200421
240 mm

Sigmoid Anastomosis Forceps

ATRAUMATIC

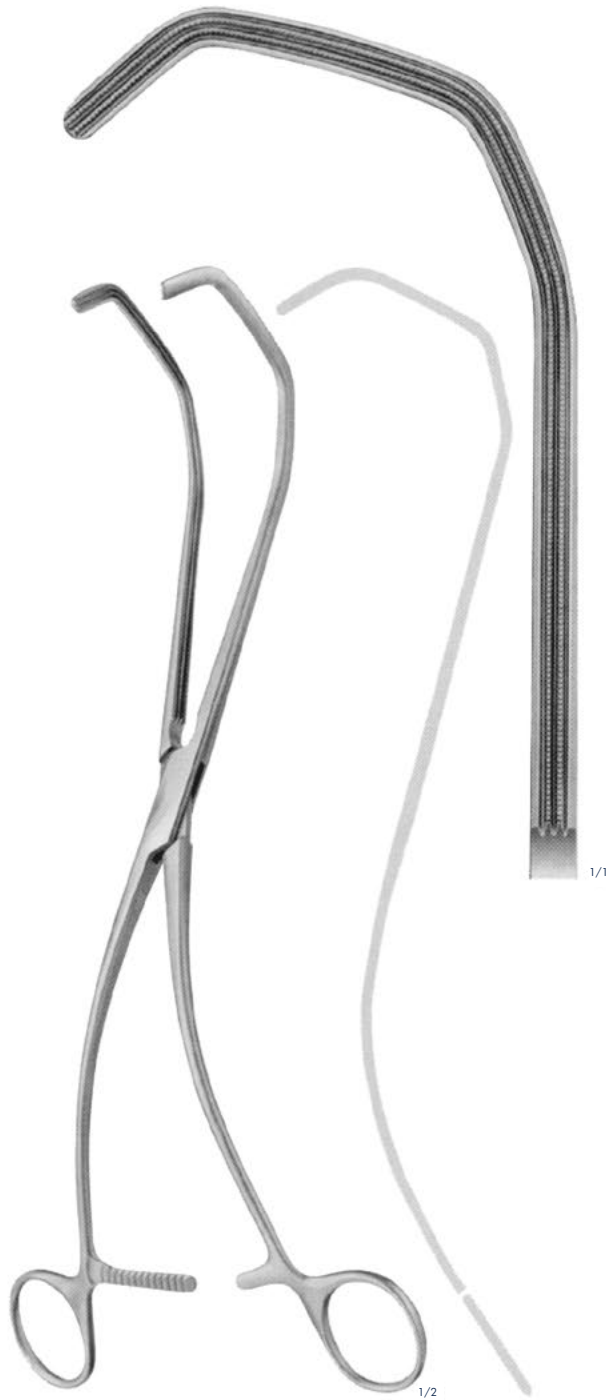

KERSTING
OS1230460
300 mm



RESANO
OS1230195
elastic
265 mm

Rectal Scissors



LLOYD-DAVIES(GOLIGHER'S)

OSI110701

Rectal scissors

270 mm

STELZNER

OSI110702-OSI110703

Rectal scissors

310 mm

OSI110704

Rectal scissors

325 mm

MÜLLER Instrument for deep Rectum Surgery

ATRAUMATIC

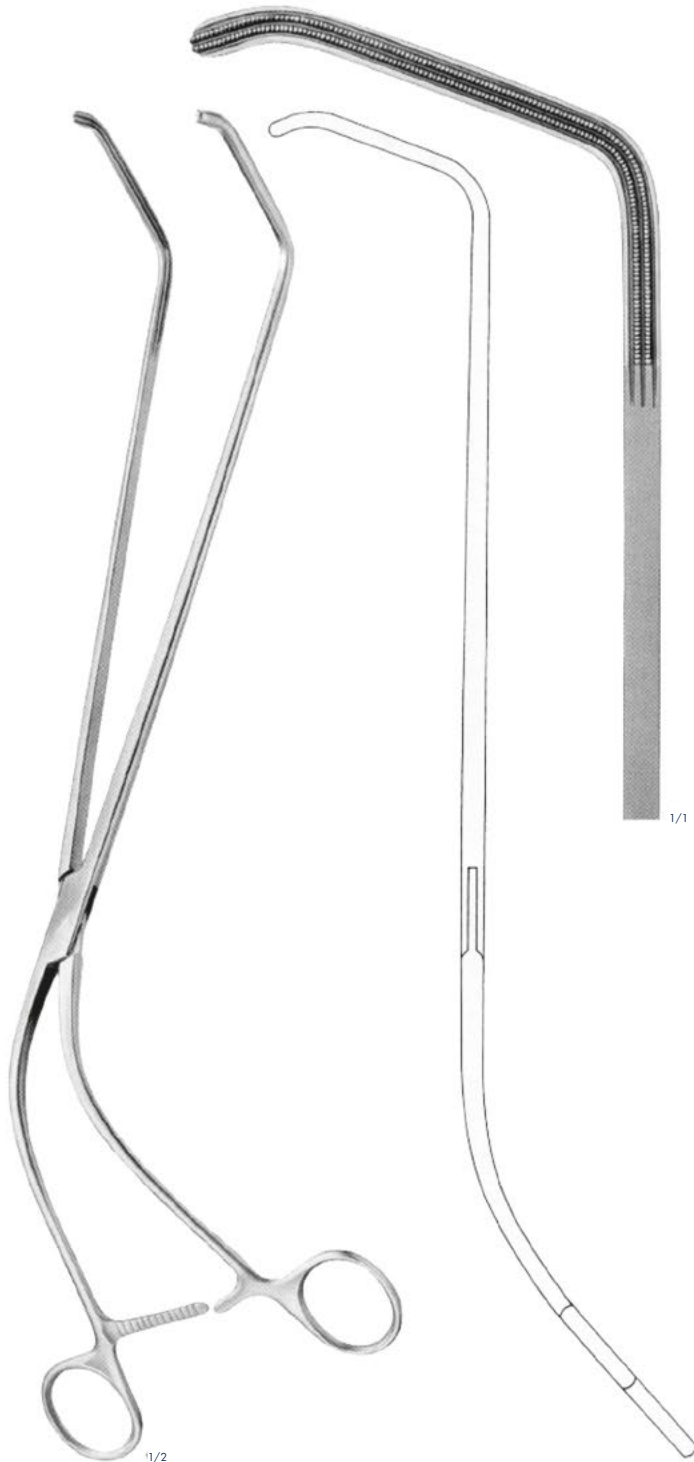

MÜLLER
OSI230461
Rectal anastomosis clamp
375 mm



MÜLLER
OSI230462
Intestinal dilator, spreading range: 26 - 40 mm
240 mm

MÜLLER Instruments for deep Ractum Surgery

ATRAUMATIC

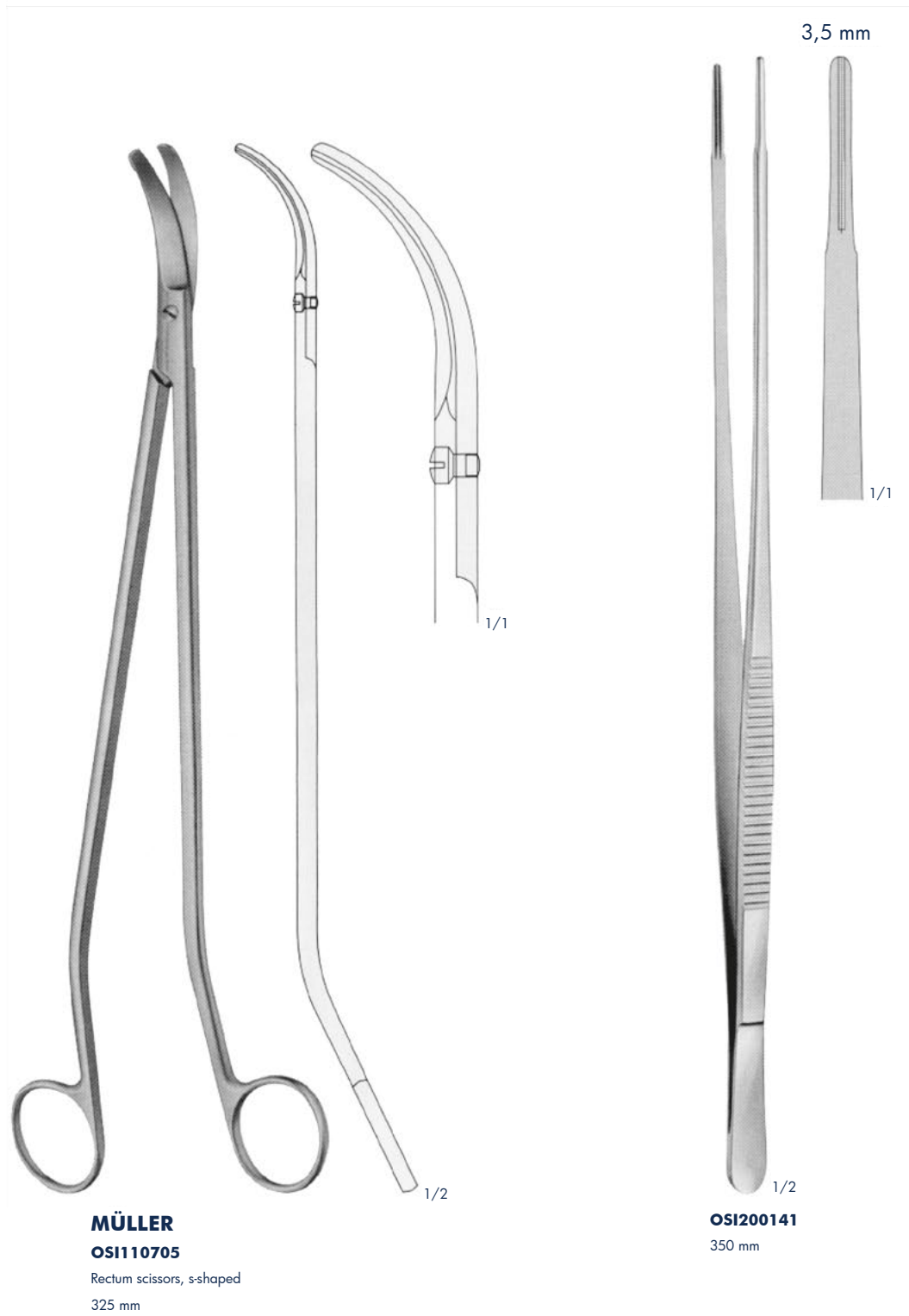

MÜLLER Instruments for deep Ractum Surgery

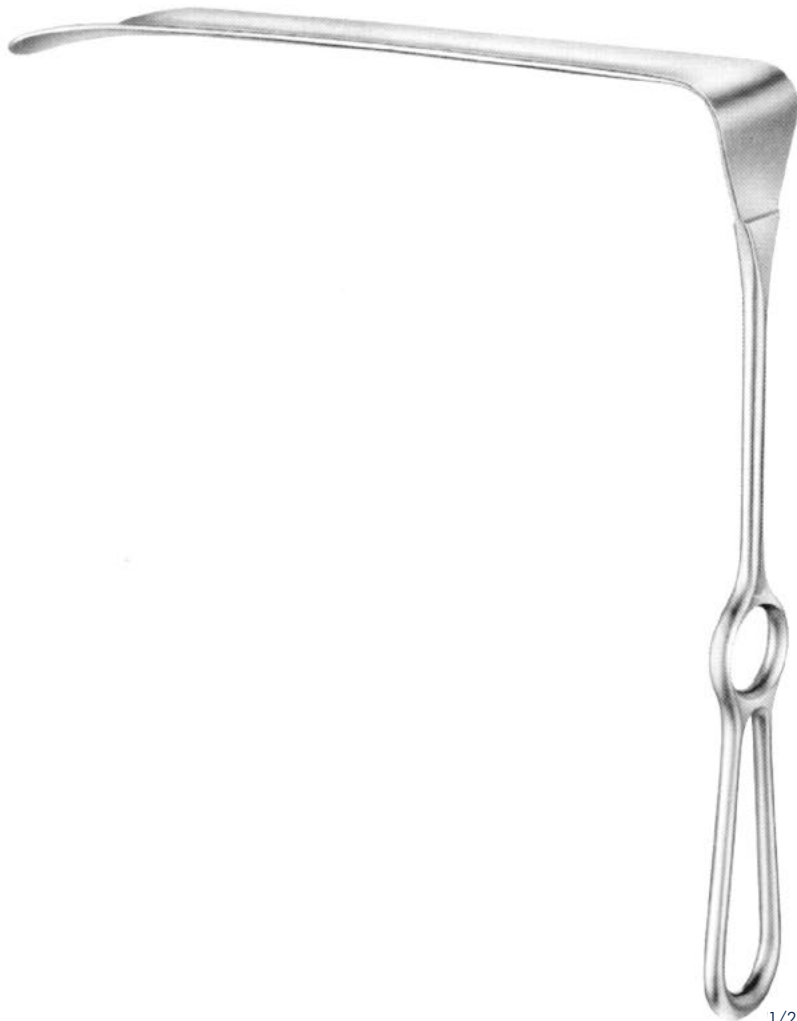
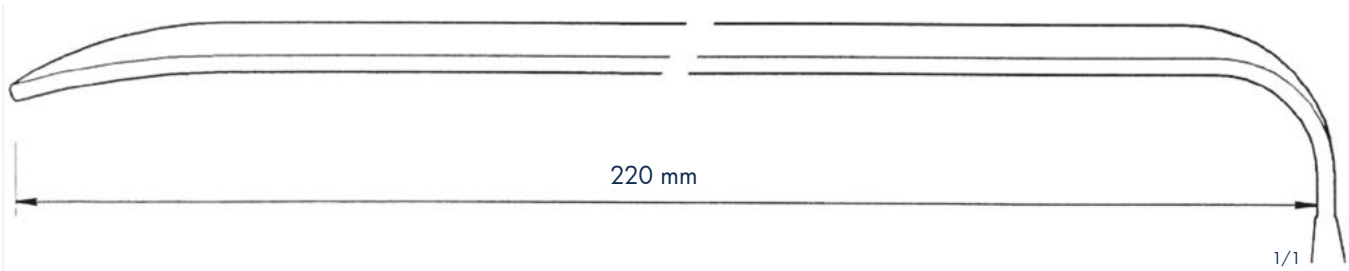

MÜLLER
OSI150634

Retractor
250 mm

220 x 40 mm

MÜLLER Instruments for deep Ractum Surgery

A T R A U M A T I C



MÜLLER
OS1170364
Needle holder
360 mm



OS1230463
Grasping Forceps
295 mm

Intestinal- and Stomach Suture Apparatus

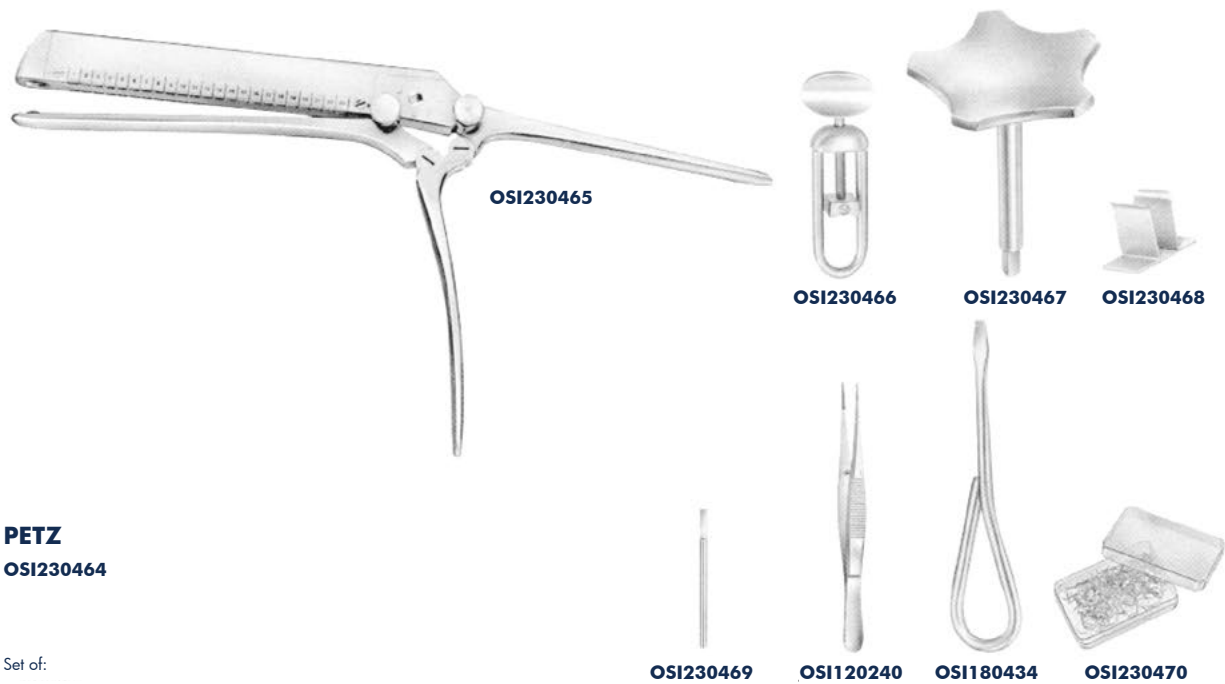

PETZ
OSI230464

Set of:

- OSI230465** 1 Intestinal-und suturing apparatus
for 23 pairs of suture clips
- OSI230466** 1 Additional closing clamp
- OSI230467** 1 Gear wheel
- OSI230468** 1 Filling rack
- OSI230469** 1 Filling pin
- OSI120240** 1 Filling tweezer
- OSI180434** 1 Screw Driver
- OSI230470** 300 Suture clips of titanium
- OSI230603** 1 Wooden case, a second suturing
apparatus can be placed in the case

Rectal Specula

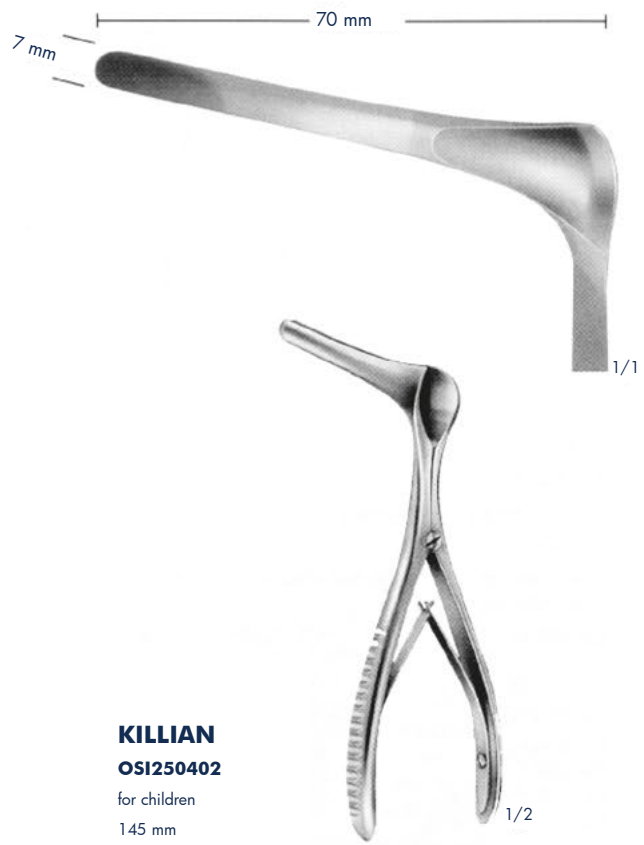

Rectal Specula

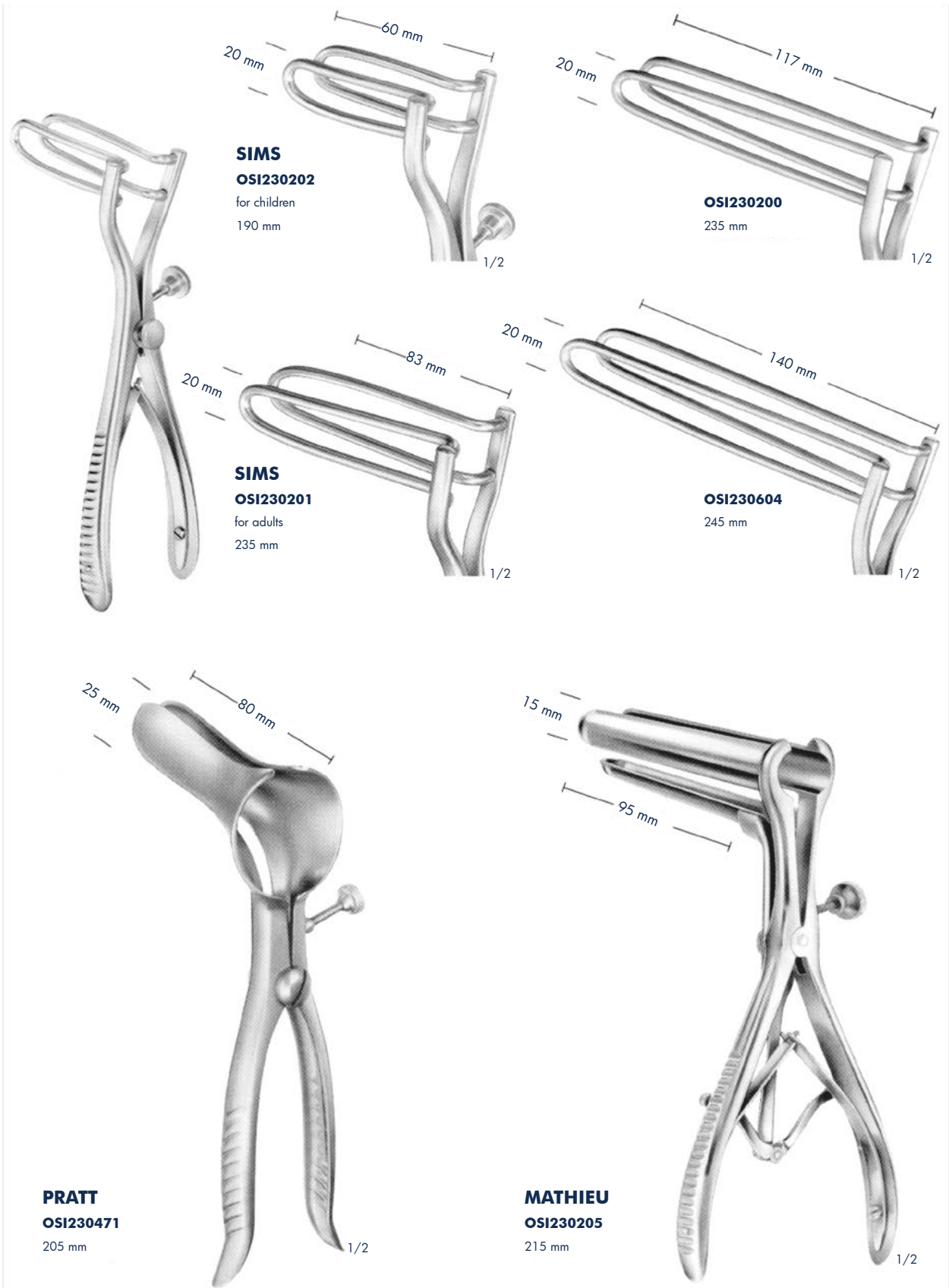

Anusopes - Sphincteroscopes



BENSAUDE

OS1230472 Ø 17 mm

OS1230473 Ø 20 mm

OS1230474 Ø 23 mm

Anusopes

185 mm



IVES-FANSLER

OS1230196 Ø 24 mm

Anusopes

145 mm



KELLY

OS1230207 Ø 21 mm

Sphincteroscope

160 mm



KELLY

OS1230208 Ø 27 mm

Sphincteroscope

160 mm

Protoscope - Rectal Retractor

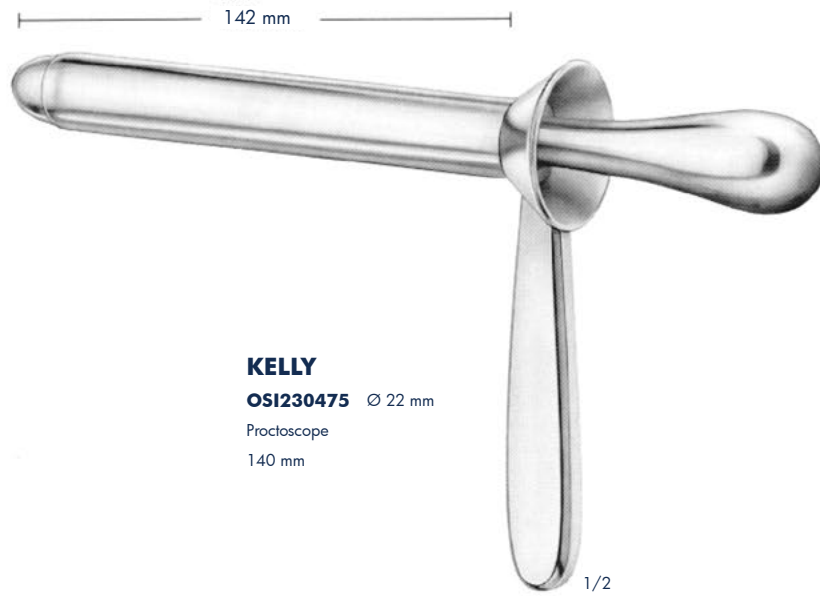

KELLY
OSI230475 Ø 22 mm
Proctoscope
140 mm

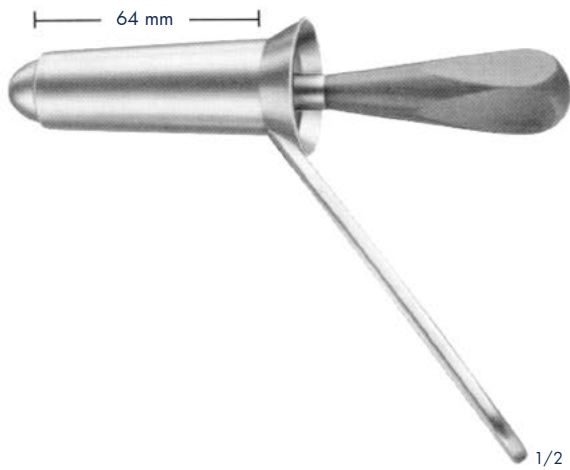

GABRIEL
OSI230476 Ø 25 mm

Rectal speculum

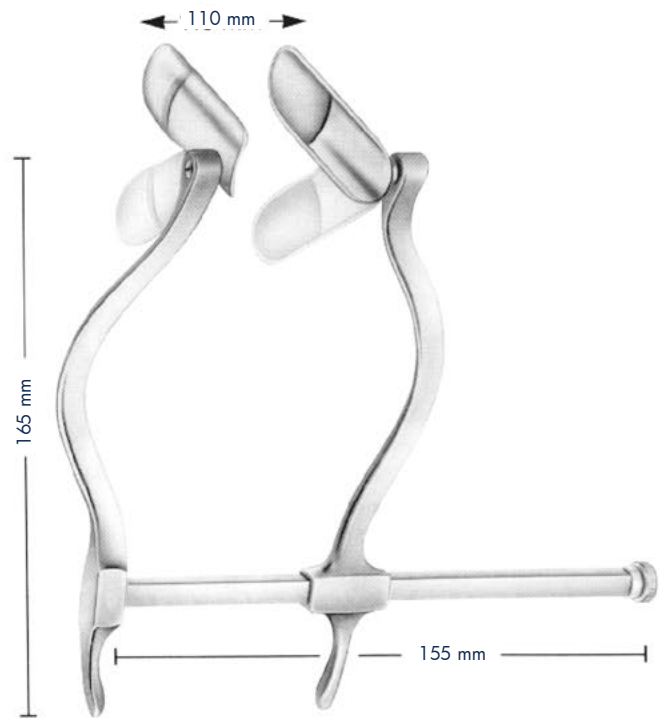

SMITH-BUIE
OSI230477

Rectal retractor
Dimension of blades: 58 x 23 mm

Rectal Specula

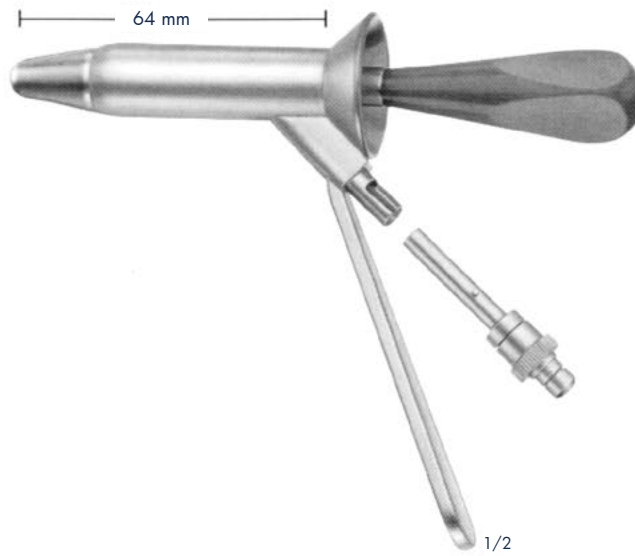

NAUNTON MORGAN

OSI230478 Ø 17 mm
fibre light

OSI230479 Ø 21 mm
fibre light

OSI230480 Ø 24 mm
fibre light

Rectal specula
165 mm



OSI230481

Spare fibre light attachment
NAUNTON MORGAN-specula

To be used with the fibre optic
light cables **OSI160380, OSI160381, OSI160457**
conjunction with adapter

Sigmoidoscope and Proctoscope

LLOYD DAVIES

OSI230605 Ø 20 mm
300 mm



LLOYD DAVIES

OSI230606 Ø 16 mm
250 mm



OSI230607

Fibre light
attachment for
OSI230608 **OSI230605**
and **OSI230606**

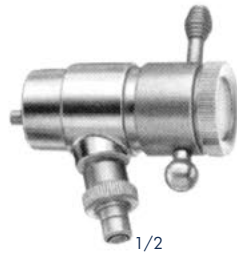

LLOYD DAVIES

OSI230608
for children

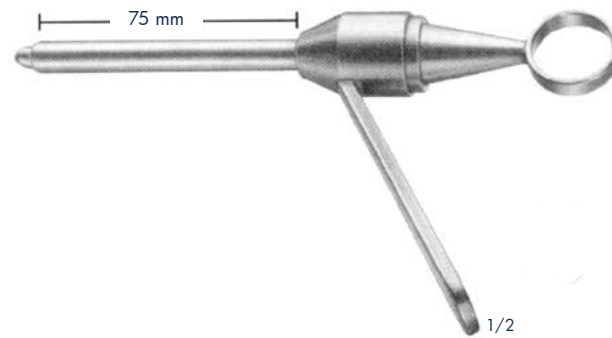

OSI230607

fibre light
attachment for
OSI230608 **OSI230605**
and **OSI230606**



OSI230609

Fibre light carrier



Rectal Spreader - Abdominal Retractor

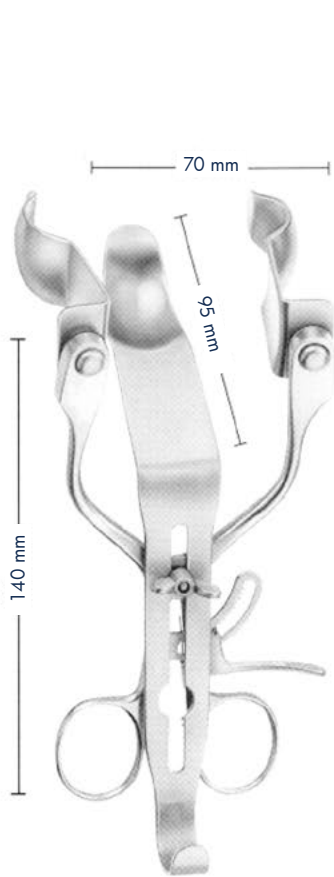

OSI230612

Rectal blades
70 mm deep
PR = pair

OSI230613

Sphincter blades
93 mm deep
PR = pair

OSI230614

Blades for anastomosis
90 mm deep
PR = pair
not included in

OSI230615

150 mm deep
PR = pair
not included in

PARS MODIF GIRONA

OSI230204

Rectal spreader

consisting of:

- OSI230610** Spreader only
- OSI230611** Center blade only
- OSI230612** Pair of blades only, 70 mm deep
- OSI230613** Pair of blades only, 93 mm deep

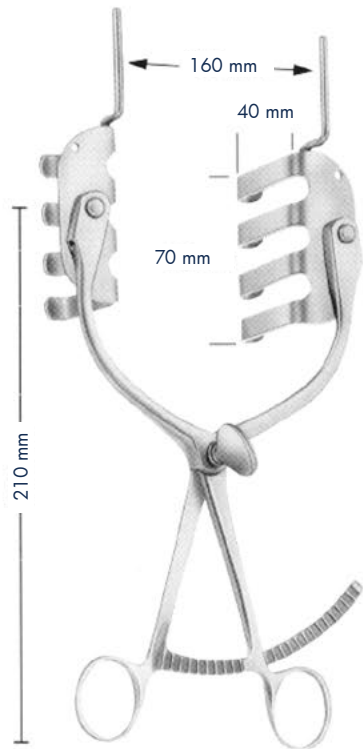

ST. MARKS, MODIF. GIRONA

OSI230482

Perineal retractor with towel pegs
fitted to swivel rake blades

Pelvis Retractors

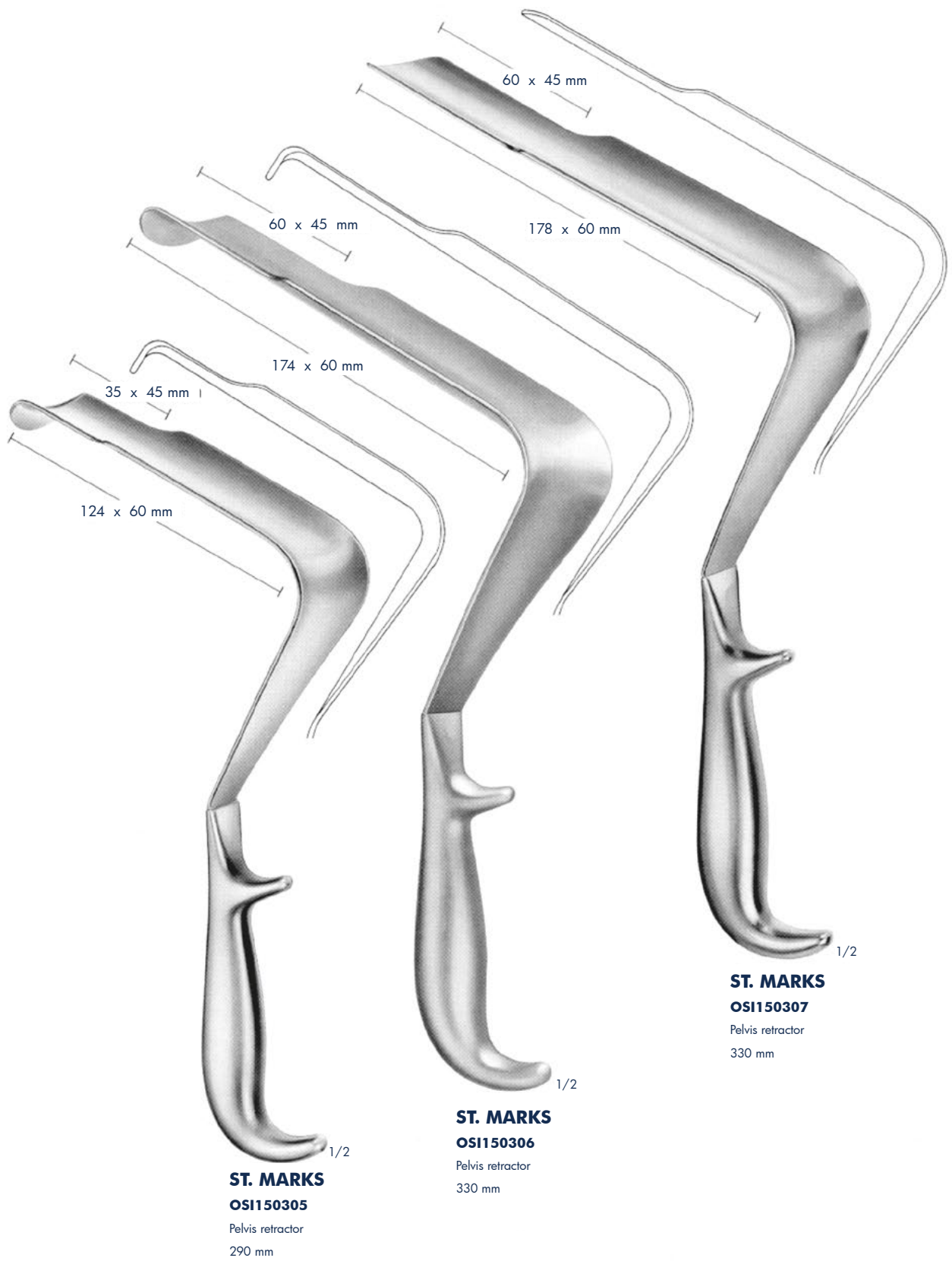

Rectal Probes



LOCKHART-MUMMERY

- OS1160222** Nr. 1 straight
 - OS1160223** Nr. 2 45° curved
 - OS1160224** Nr. 3 90° curved
 - OS1160225** Nr. 4 retrograde curved
- Fistula probes
165 mm



BRODIE

OS1160221
Director with tip,
diam. of tip 3,5 mm
200 mm

OS1160226
Director wire loop,
malleable
190 mm

OS1160141
Double ended probe,
malleable, diam. of tips
3 mm with hole
190 mm

OS1230616
Fistula probe (Krypt hook)
240 mm

Biopsy Forceps For Rectum

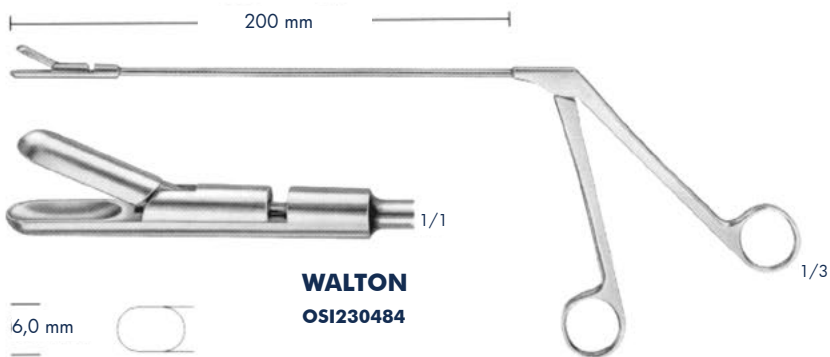
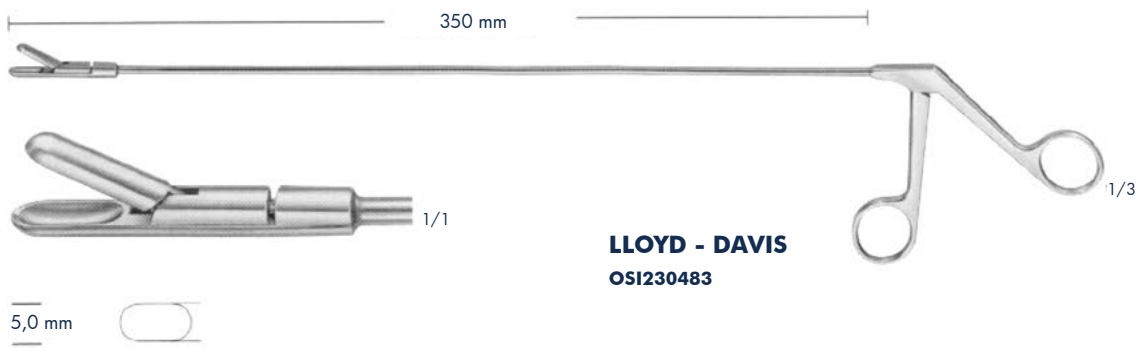

Biopsy Forceps For Rectum



with drawing cut



Biopsy Forceps and Swab Holders for Rectum

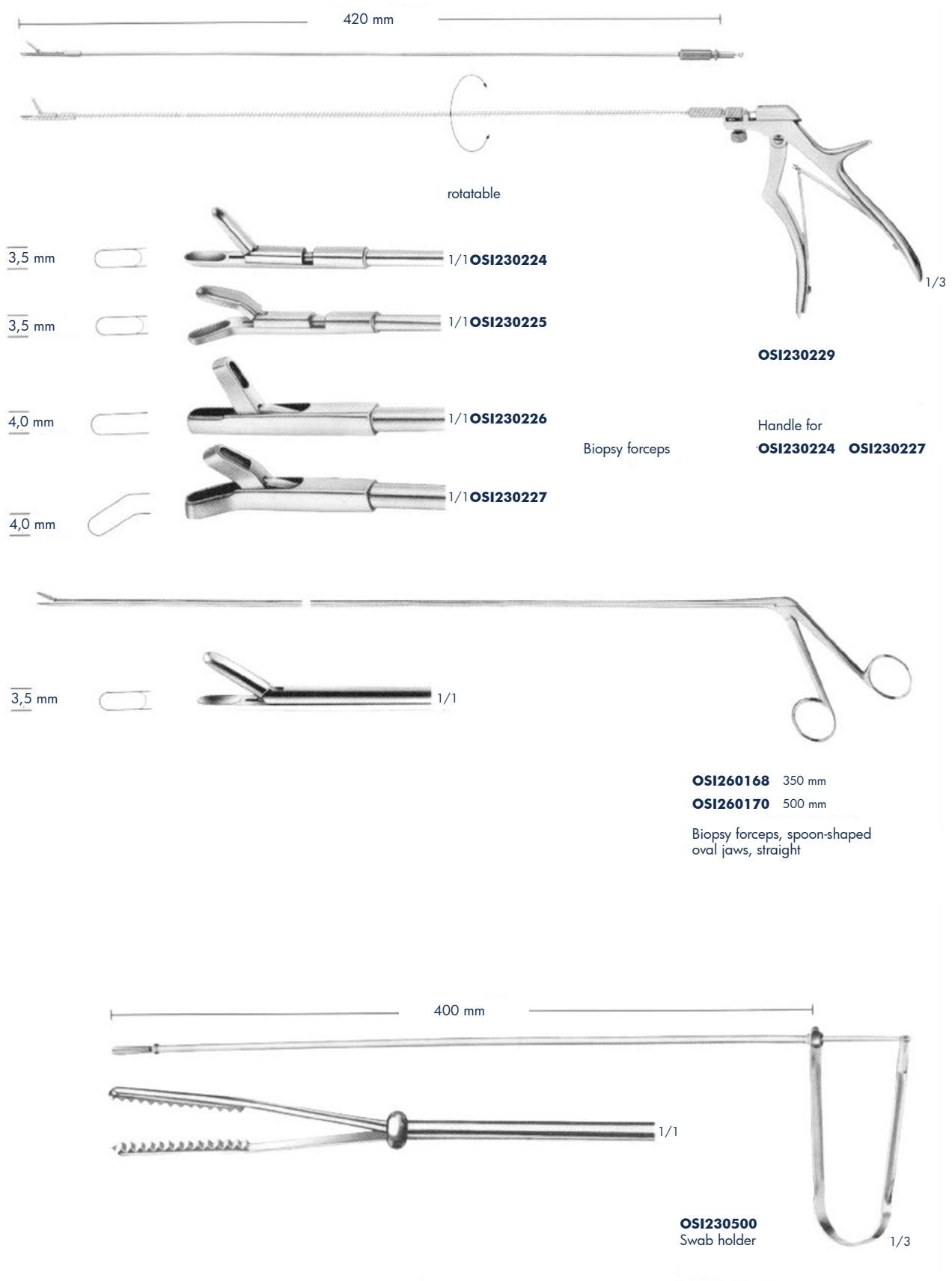

Haemorrhoidal Forceps



LUER
OS1230501 - OS1230231

OS1230501
220 mm

OS1230231
245 mm



HEYWOOD-SMITH
OS1230232
200 mm

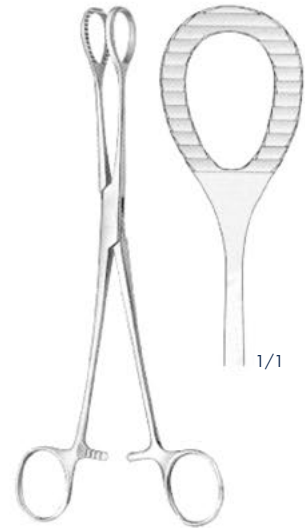

HEYWOOD-SMITH modif.
OS1230233
215 mm

ATRAUMATIC

Pressure clamp

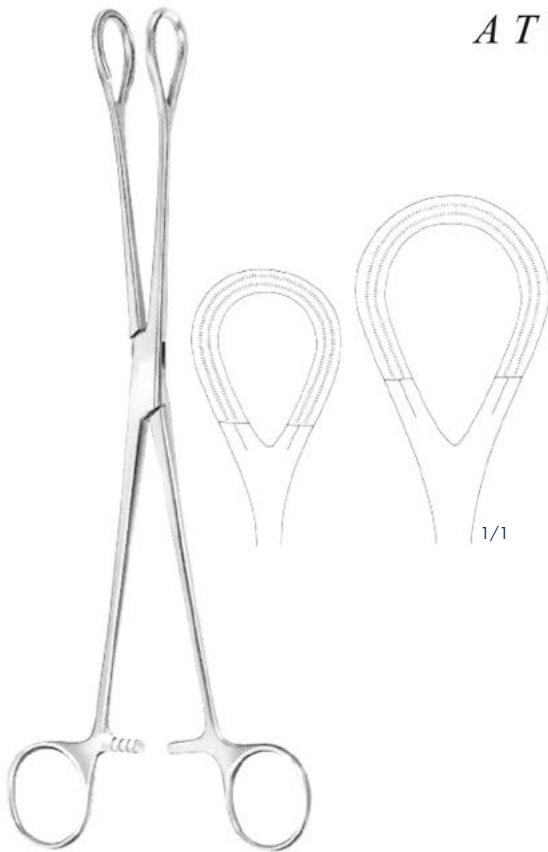

OS1130127 250 mm
OS1130128 270 mm

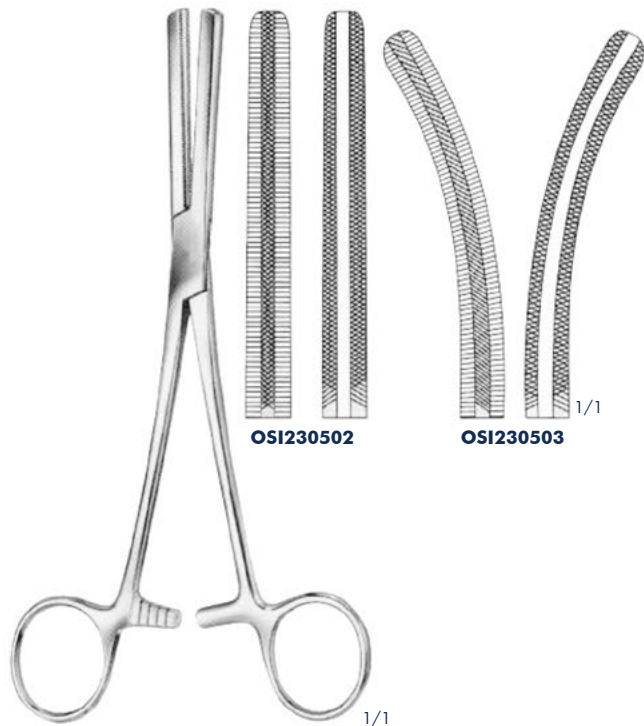

FERGUSSON
OS1230502 - OS1230503
200 mm

Haemorrhoidal Ligator



RUDD

OSI230504

Haemorrhoidal ligator
with loading attachment
and 100 ligature rubber rings
315 mm



MC GIVNEY

OSI230505

Haemorrhoidal forceps
185 mm

1/2

1/1

1/2



1/1

OSI230506

Ligature rubber rings
Sales Unit:
PH = Package of 100 pieces

Haemorrhoidal Ligator

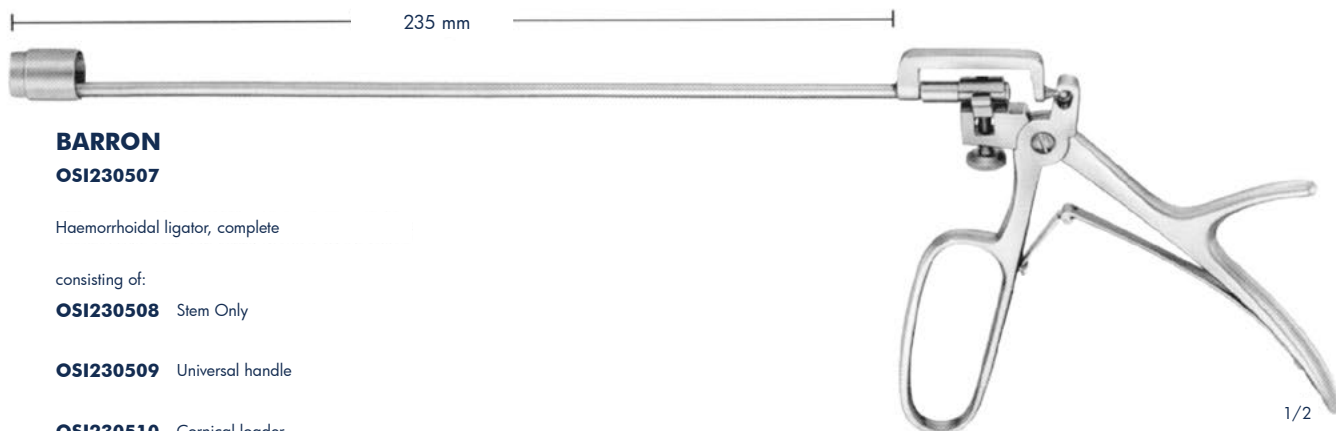

BARRON
OSI230507

Haemorrhoidal ligator, complete

consisting of:

OSI230508 Stem Only

OSI230509 Universal handle

OSI230510 Cornical loader

Suitable Ligatur rubber rings: **OSI230506** (see back page)

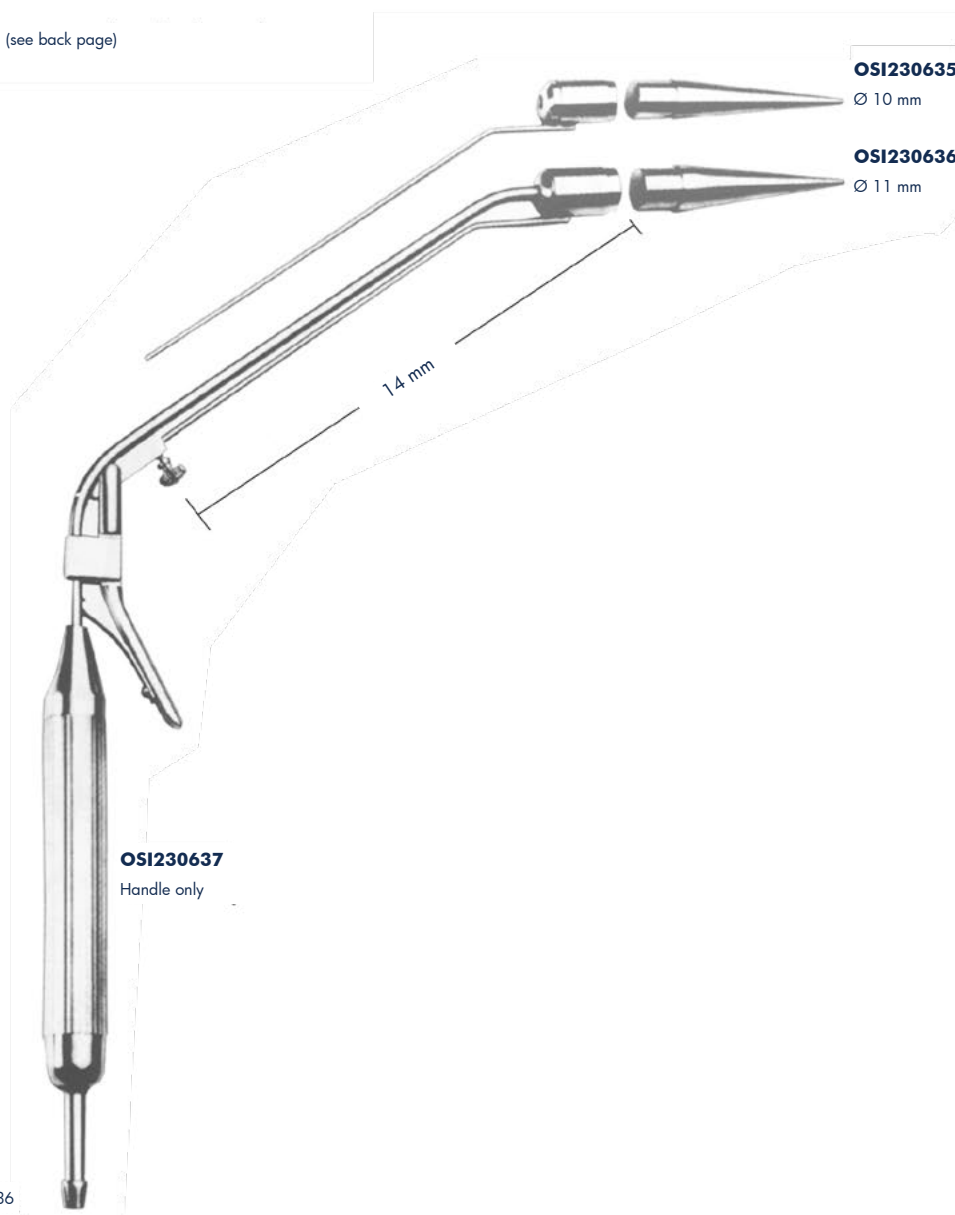

OSI230635

Ø 10 mm

OSI230636

Ø 11 mm

1.4 mm

OSI230637
Handle only

OSI230640

Complete

(OSI230637 - OSI230635 - OSI230636)

Rectal Cannula Haemorrhoidal Syringe, Haemorrhoidal Cannula



KATZENSTEIN
OSI230617

Rectal cannulae
75 mm



GABRIEL
OSI230618

Haemorrhoidal syringe
10 ml



GABRIEL
OSI230619

Haemorrhoidal cannula, straight
75 mm



GABRIEL
OSI230620

Haemorrhoidal cannula, straight
100 mm



GABRIEL
OSI230621

Haemorrhoidal cannula, angled
100 mm



OSI230622

Haemorrhoidal cannula, with Luer-Lock attachment



OSI240750
Uterine cannula with spring
connector, self-retaining
complete with
2 interchangeable cones
large and small
25 cm

Gall Duct Forceps



LOWER
OSI230511

180 mm

LAHEY (SWEET)
OSI230512

200 mm

LAHEY
OSI130524

225 mm

DESJARDINS
OSI130320

Gall duct and cystic forceps
220 mm

NISSEN
OSI230513

Gall duct and cystic forceps
215 mm

Gall Duct Forceps and Choledochus Forceps



OSI130343
230 mm

OSI130344
240 mm

MOYNIHAN
OSI130343 - OSI130344



OSI130318

OSI130319

Cholecystectomy
forceps

GRAY
OSI130318 - OSI130319
220 mm



OSI130471

OSI130472

HOSEMANN
OSI130471 - OSI130472

Choledochus forceps
215 mm



MIXTER
OSI130306

Gall duct and cystic forceps
230 mm

Gall Bladder Forceps

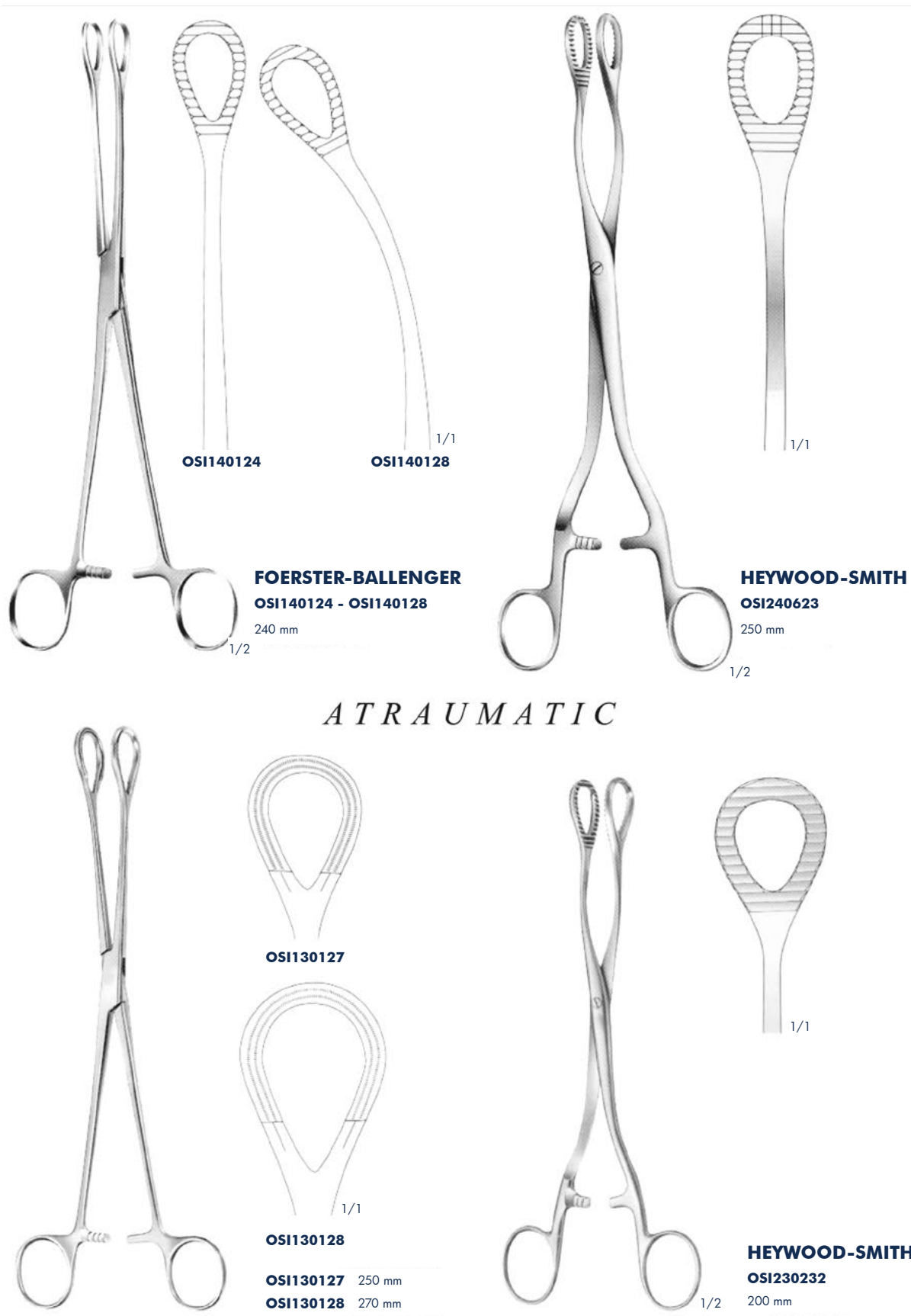

Gall Bladder Forceps and Gall Duct Scissors



HEYWOOD-SMITH modif.
OSI230233
 215 mm



DOYEN
OSI240266
 185 mm



OSI110675

sharp/sharp
 for opening the
 gall bladder
 225 mm



**POTTS-
 DE MARTEL MILLS**
OSI110299 OSI110300

60° 60°

OSI110299 - OSI110300
 Gallen duct scissors
 220 mm



DE BAKKEY
OSI110643

Gallen duct
 scissors
 220 mm

Gall Duct Probes

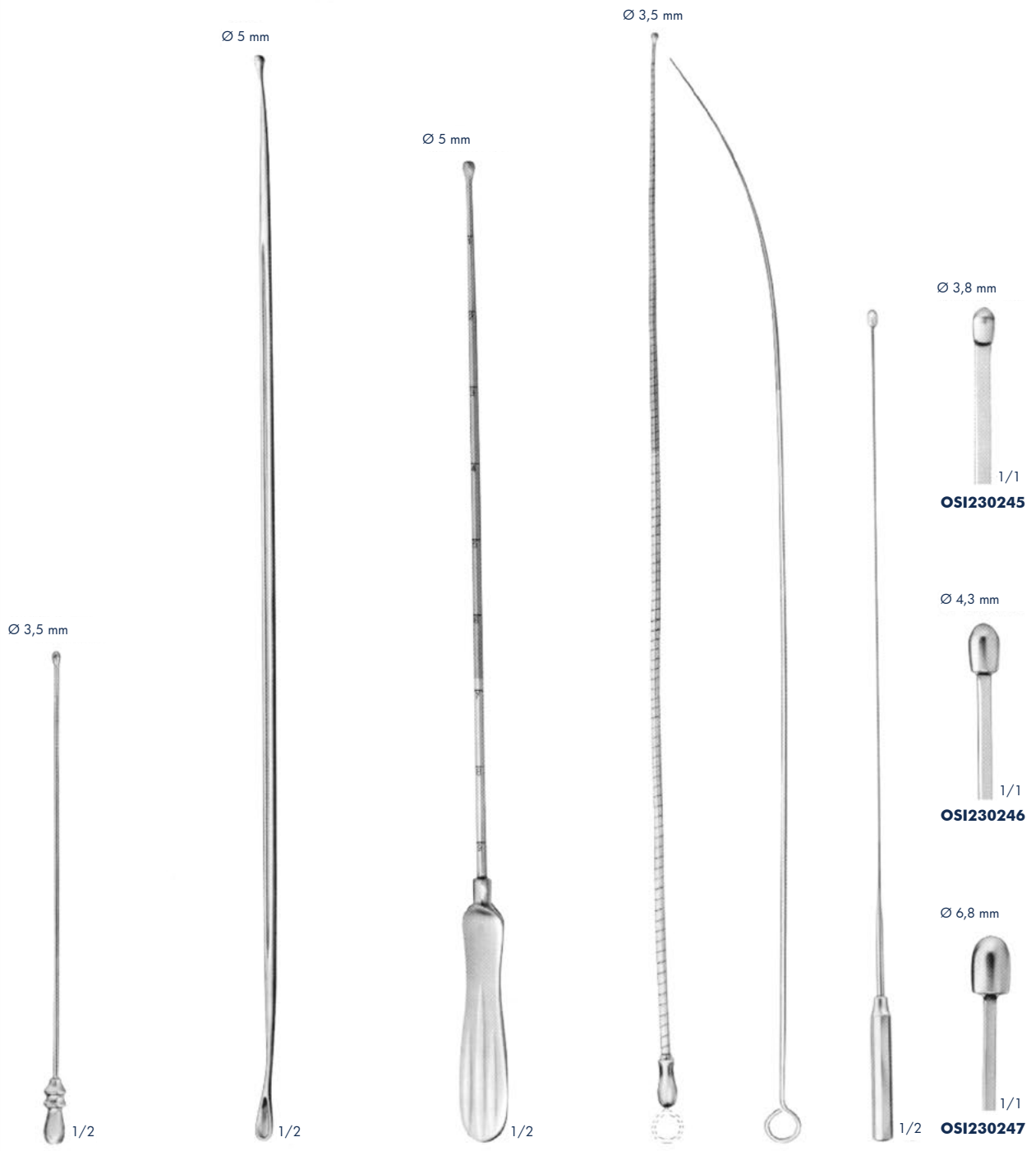

HAJEK
OSI260453

Irrigating cannulae,
silver
165 mm

MOYNIHAN
OSI230244

biegsam
Gall stone probe
and-scoop of tin,
malleable
365 mm

MAYO
OSI240594

Gall duct probe,
malleable
330 mm

OCHSNER
OSI230514

Gall duct probe,
flexible
400 mm

DESJARDINS
OSI230245 - OSI230247

Gall duct probes,
flexible
285 mm

Papillotome



After the dilator has been introduced into the papille duodeni screw of the handle and attach a suitable cone of **OSI230517**. Any further introduction into the papille duodeni is thus avoided.

Handle to screw off

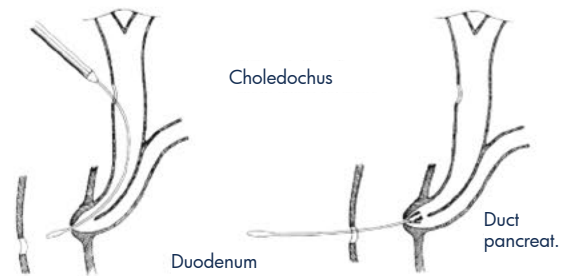

Lifting the papille duodeni and piercing.

STÜCKER

OSI230515 - OSI230516 325 mm

Bile duct dilators, 3 and 4 mm diam., malleable.
Handle can be screwed off and any cone of

can be fitted.



OSI230517

Set of cones, 3 pieces on holder, for screwing on shaft of

OSI230515 - OSI230516

OSI230518

Papillotome consisting of:

Dilator **OSI230515** and set of cones **OSI230517**

Papillotome

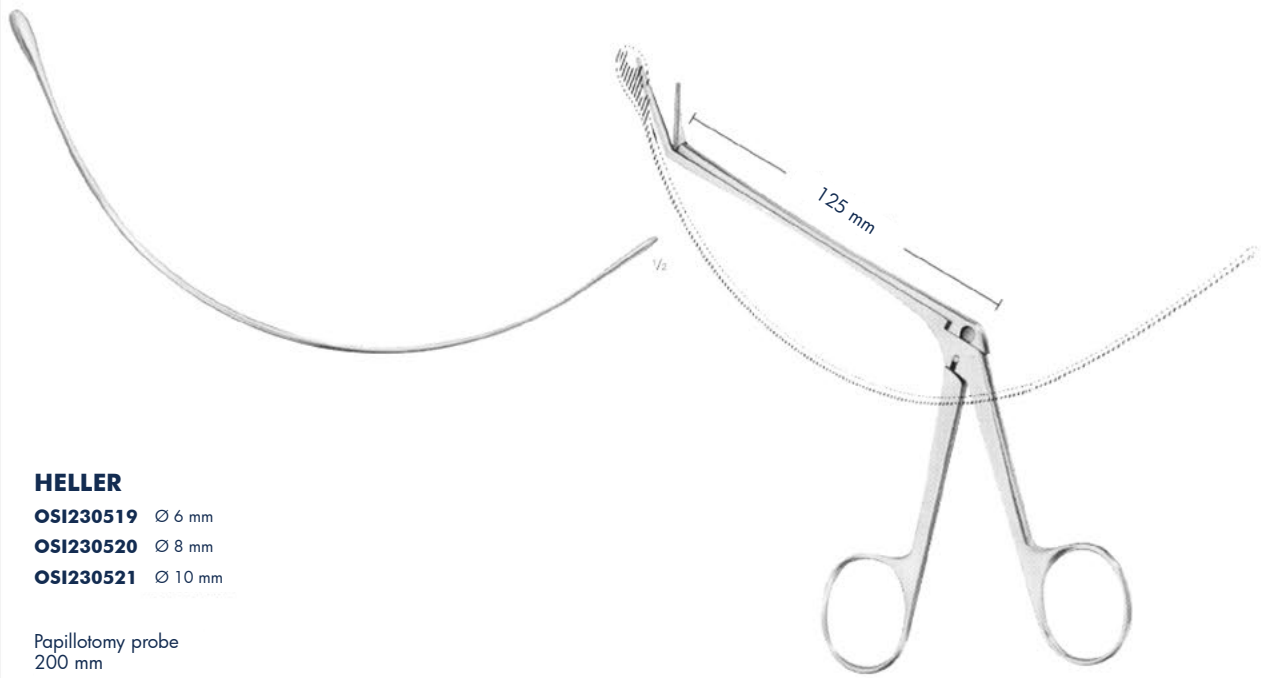

HELLER

OSI230519 Ø 6 mm

OSI230520 Ø 8 mm

OSI230521 Ø 10 mm

Papillotomy probe
200 mm

HELLER OSI230522

Biopsy forceps for papilla

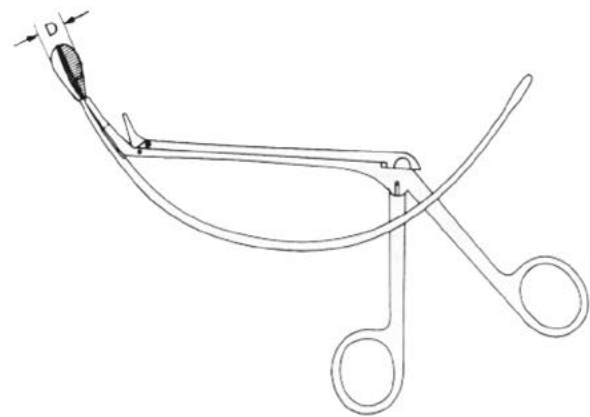

Biopsy Forceps for transduodenal papillotomy

Application:

In papillotomy the malleable probe is introduced from choledochotomy into duodenum in the conventional way. Lifting the papille into the duodenum wound is done with the cone, available in size 6, 8 and 10 mm diam. Then the forceps is introduced into the groove of the cone and pushed forward. By closing the forceps jaws, incision is achieved with simultaneous biopsy. The biopsy taken remains in the "basket" and can easily be removed.

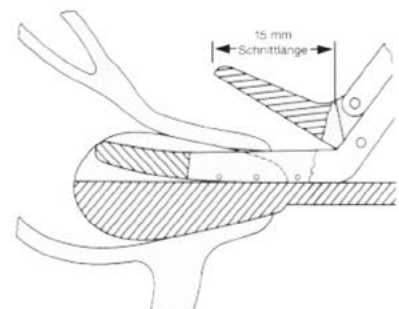

Gall Duct Dilators



1/2

DITTEL

OSI230356 - OSI230378

Metal bougies and dilating sounds, stiff
345 mm

Charr.
(French)

- OSI230356 8
- OSI230357 9
- OSI230358 10
- OSI230359 11
- OSI230360 12
- OSI230361 13
- OSI230362 14
- OSI230363 15
- OSI230364 16
- OSI230365 17
- OSI230366 18
- OSI230367 19
- OSI230368 20
- OSI230369 21
- OSI230370 22
- OSI230371 23
- OSI230372 24
- OSI230373 25
- OSI230374 26
- OSI230375 27
- OSI230376 28
- OSI230377 29
- OSI230378 30



OSI230248
Ø 1 mm

OSI230249
Ø 2 mm

OSI230250
Ø 3 mm

OSI230251
Ø 4 mm

OSI230252
Ø 5 mm

1/1

OSI230253
Ø 6 mm

OSI230254
Ø 7 mm

OSI230255
Ø 8 mm

OSI230256
Ø 9 mm

OSI230257
Ø 10 mm

1/1

OSI230258
Ø 11 mm

OSI230259
Ø 12 mm

OSI230260
Ø 13 mm

1/1

BAKES

OSI230248 - OSI230260

Common bile duct dilators,
malleable

OSI230248 - OSI230252 315 mm

OSI230253 - OSI230260 320 mm

OSI230623

Set of 9 pieces OSI230250 - OSI230258 in canvas roll

OSI230624

Canvas roll only

Gall Duct Dilators



OSI230530



OSI230529



OSI230528



OSI230527



OSI230526



OSI230525



OSI230524

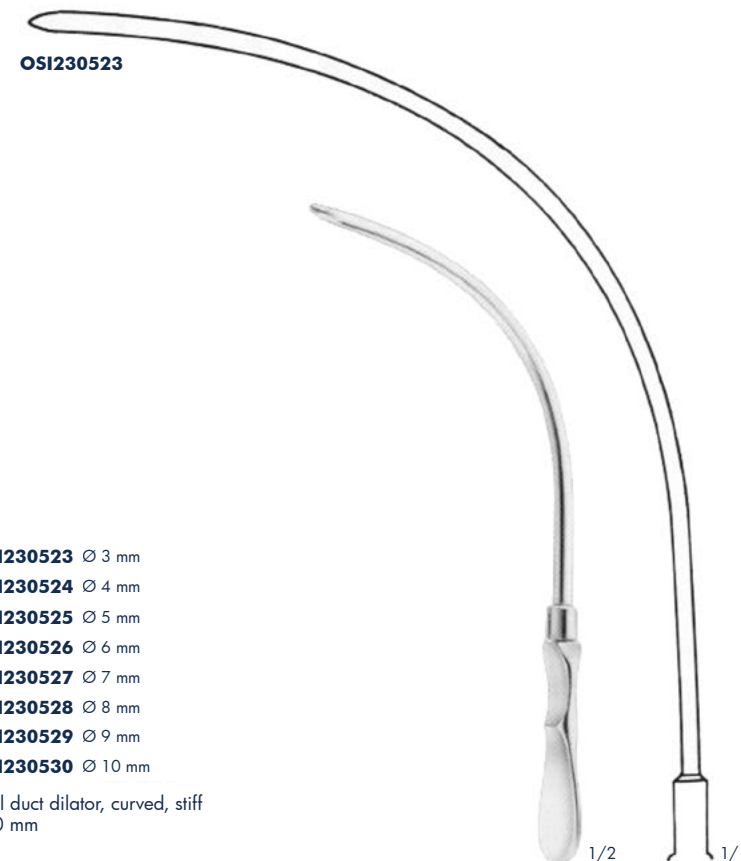

OSI230523

OSI230523 Ø 3 mm

OSI230524 Ø 4 mm

OSI230525 Ø 5 mm

OSI230526 Ø 6 mm

OSI230527 Ø 7 mm

OSI230528 Ø 8 mm

OSI230529 Ø 9 mm

OSI230530 Ø 10 mm

Gall duct dilator, curved, stiff
190 mm

1/2

1/1

Gall Stone Scoops

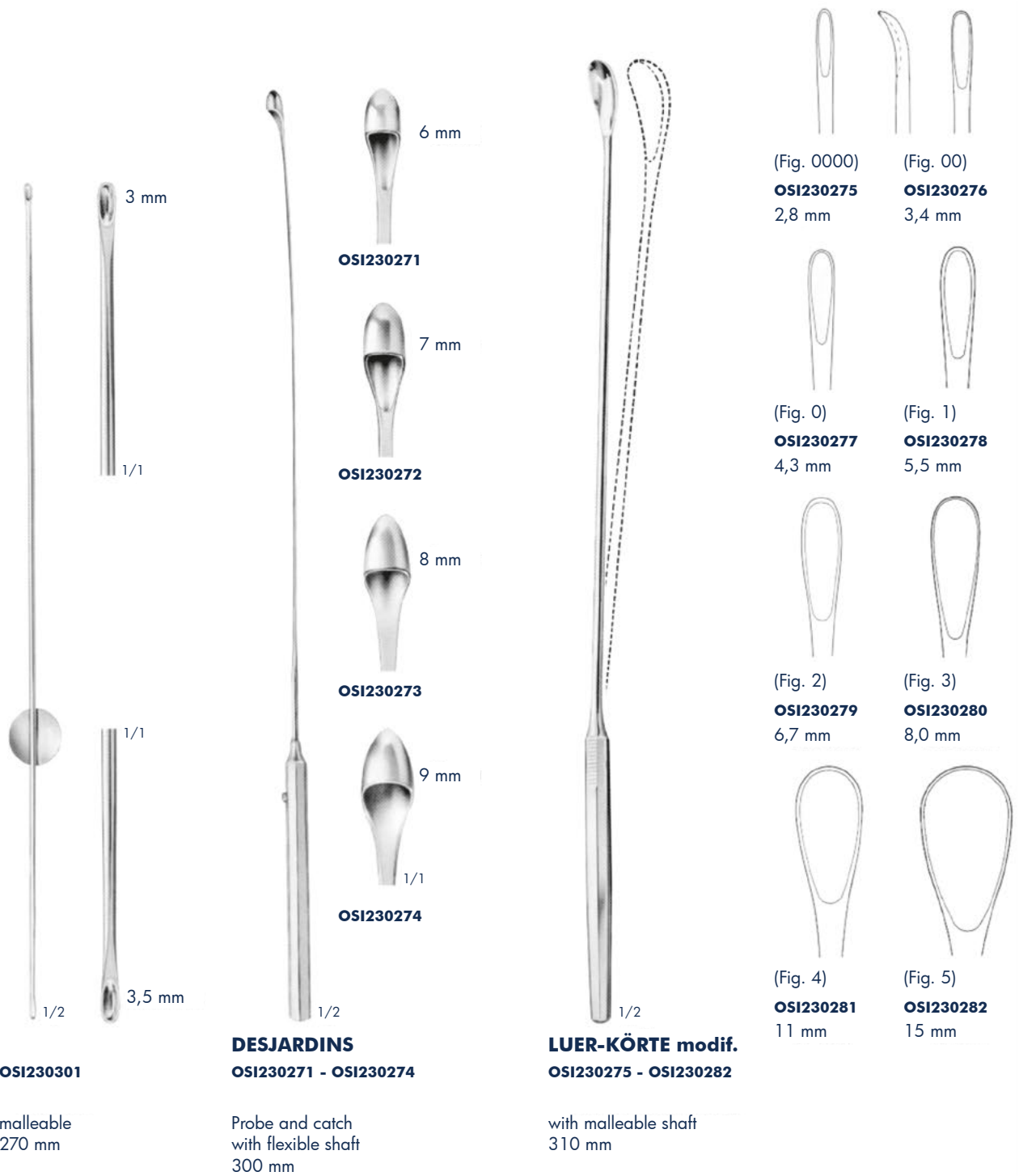

OSI230301

malleable
270 mm

DESJARDINS
OSI230271 - OSI230274

Probe and catch
with flexible shaft
300 mm

LUER-KÖRTE modif.
OSI230275 - OSI230282

with malleable shaft
310 mm

(Fig. 0000)
OSI230275
2,8 mm

(Fig. 00)
OSI230276
3,4 mm

(Fig. 0)
OSI230277
4,3 mm

(Fig. 1)
OSI230278
5,5 mm

(Fig. 2)
OSI230279
6,7 mm

(Fig. 3)
OSI230280
8,0 mm

(Fig. 4)
OSI230281
11 mm

(Fig. 5)
OSI230282
15 mm

Gall Stone Forceps



BLAKE
OS1230264
205 mm

1/2



BLAKE
OS1230265
205 mm

1/2



OSI230531
210 mm

1/2



CZERNY
OS1230261
245 mm

1/2



PELKMANN
OS1240601
260 mm

1/2

Gall Stone Forceps



OSI230268 **OSI230532**

OSI230269 **OSI230533**
1/1

DESJARDINS
OSI230268 - OSI230533
225 mm

1/1



OSI230534 **OSI230535**
1/1

Extremely delicate patterns

DESJARDINS
OSI230534
240 mm
OSI230535
225 mm

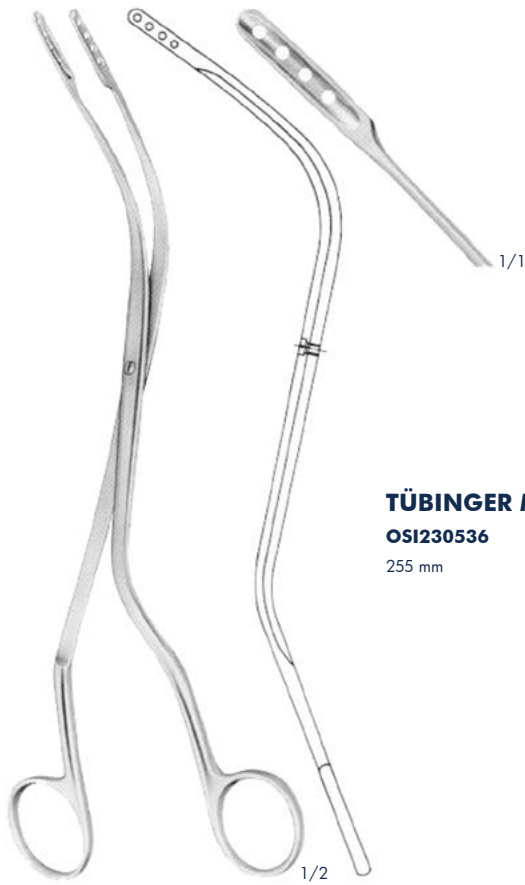

TÜBINGER MODELL
OSI230536
255 mm

1/2

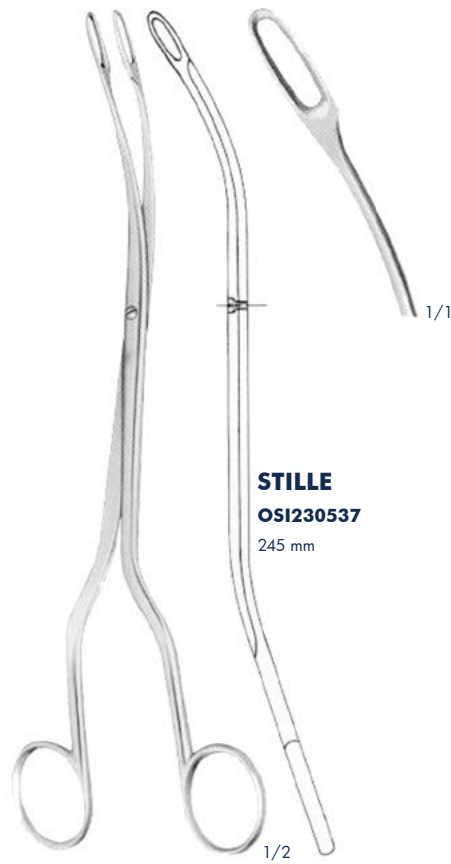

STILLE
OSI230537
245 mm

1/2

Kidney Clamps

ATRAUMATIC



Kidney Clamps

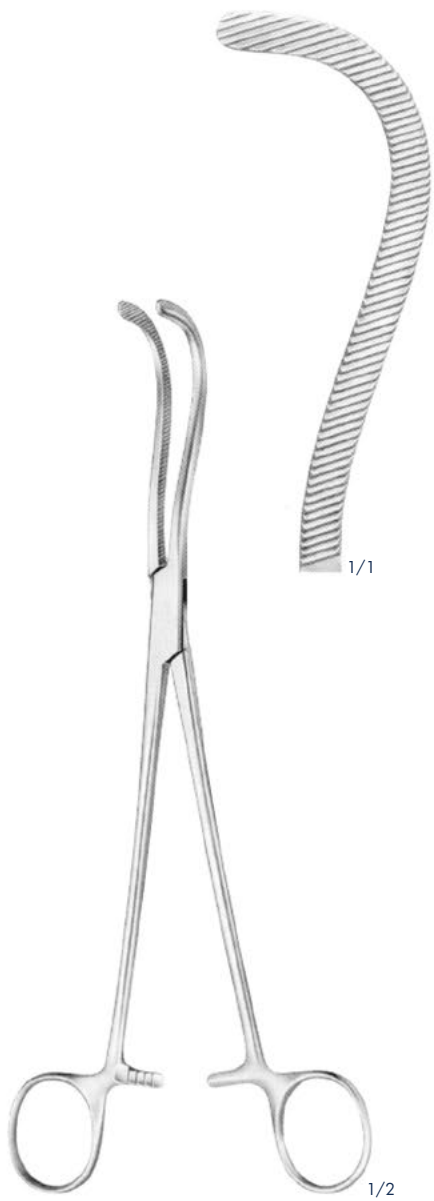

GUYON
OSI230423
235 mm

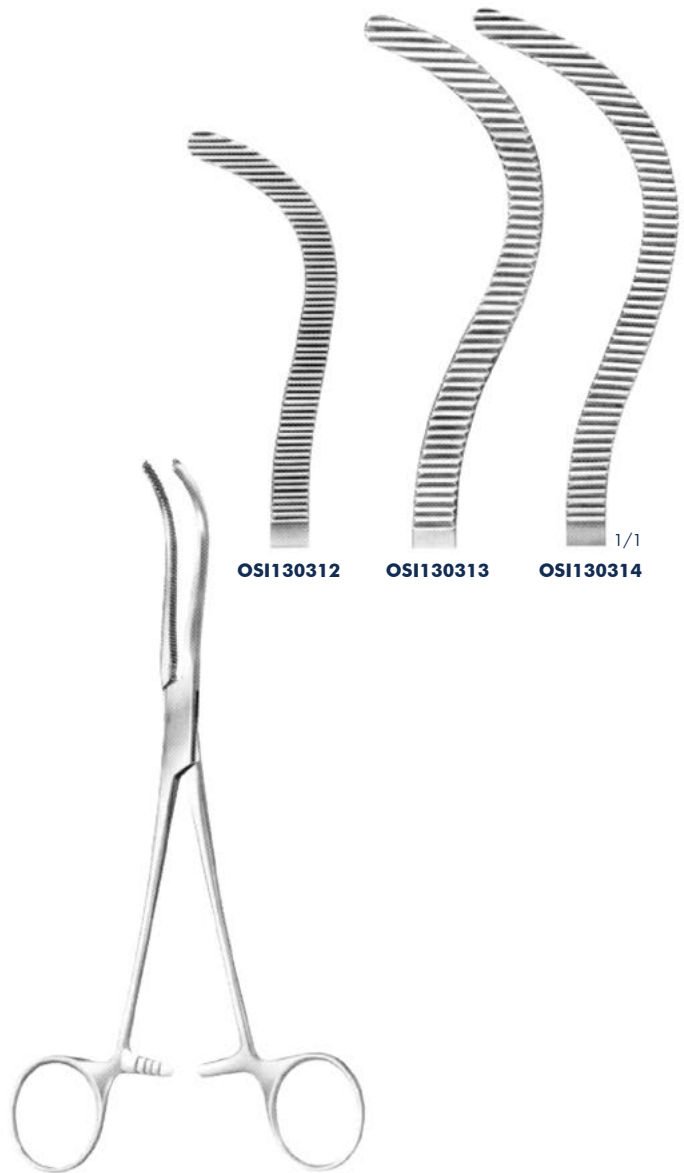

PEAN
OSI130312 195 mm
OSI130313 220 mm
OSI130314 230 mm

Kidney Clamps



Kidney Pedicle Clamps



HERRICK
OSI130317
225 mm



WERTHEM
OSI130557
255 mm

Kidney Pedicle Clamps

ATRAUMATIC



Angle - and Pressure clamp



WERTHEIM-CULLEN
OSI130341
215 mm



Angle - and Pressure clamp



WERTHEM
OSI130560
250 mm

Kidney Elevating Forceps



COLLIN
OSI240627
285 mm

1/2



DARTIGUES
OSI240270
255 mm

1/2

Kidney Stone Forceps



OSI230426

OSI230234

OSI230235

OSI230427 1/1

OSI230236

OSI230237 1/1

HEIMING

OSI230426 170 mm

OSI230427 160 mm

for children

RANDALL

OSI230234 - OSI230237

225 mm

Kidney Stone Forceps

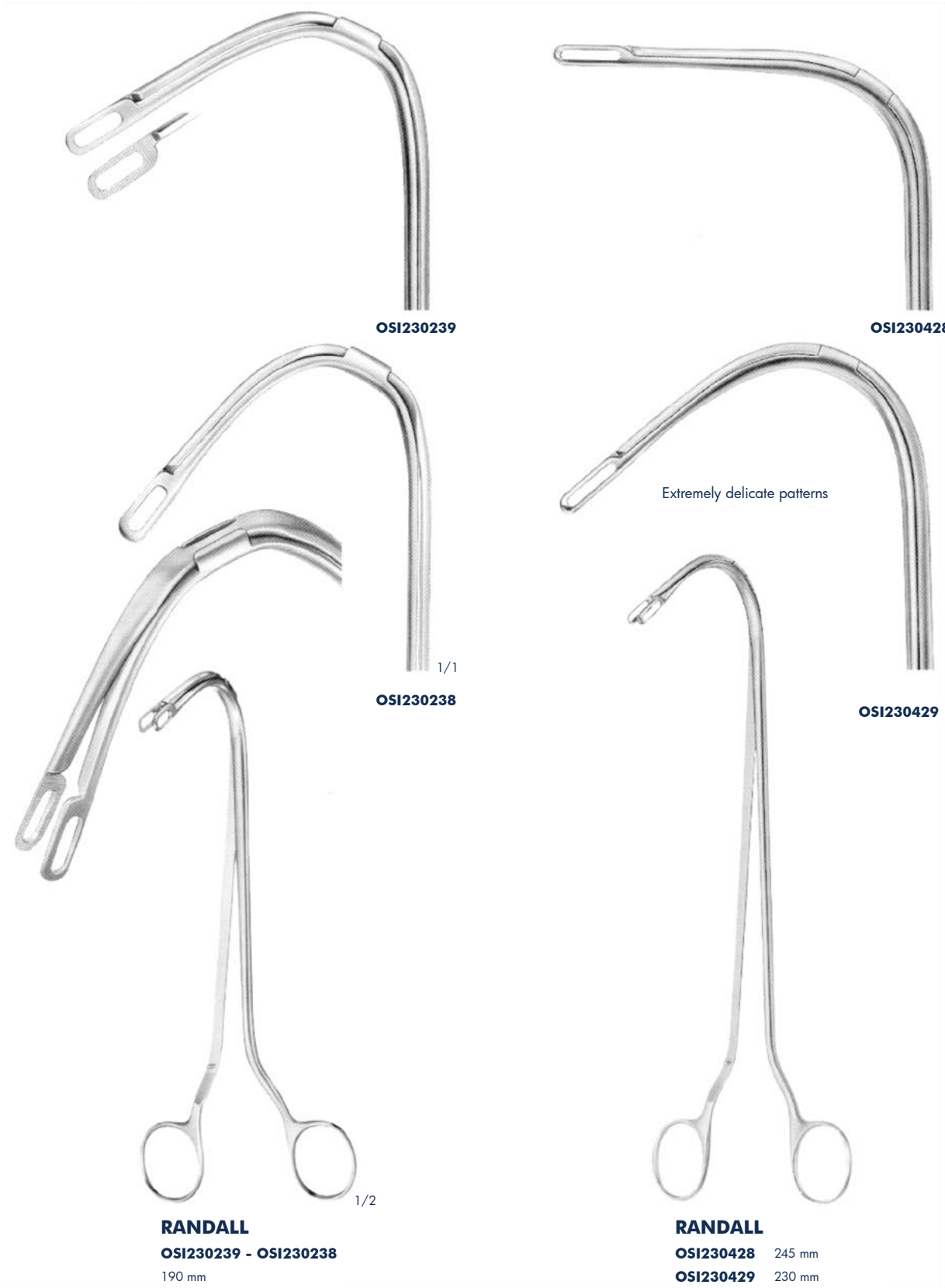

Bladder Retractors

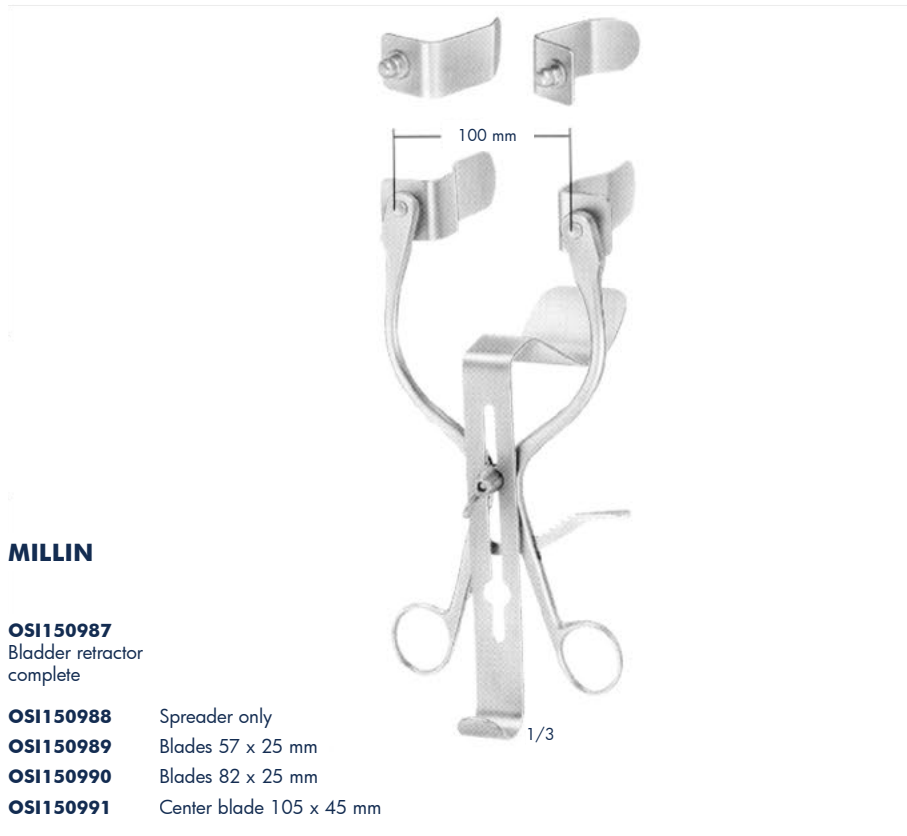

MILLIN

OSI150987
Bladder retractor
complete

- OSI150988** Spreader only
- OSI150989** Blades 57 x 25 mm
- OSI150990** Blades 82 x 25 mm
- OSI150991** Center blade 105 x 45 mm



LEGUEU OSI150992

Bladder retractor
Center blade 80 x 31 mm



LEGUEU OSI230296

Bladder spatula
260 mm

ATRAUMATIC



MILLIN
OSI230293

Lobe grasping forceps
245 mm



MILLIN
OSI230292

Lobe grasping forceps
235 mm



MILLIN
OSI230430

Lobe grasping forceps
245 mm



MILLIN
OSI230295

Bladder neck spreader
285 mm



Genito-Urinary Instruments



OSI230432

ATRAUMATIC

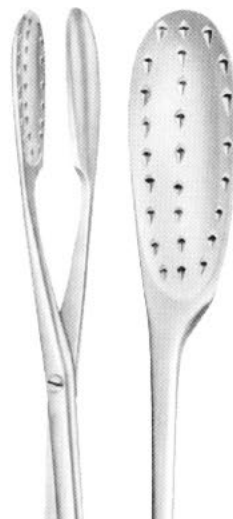

OSI230433



1/2

YOUNG
OSI230431

Prostatic lobe forceps
205 mm



1/2

LEWKOWITZ
OSI230432 - OSI230433

Lithotomy forceps
245 mm



1/2

1/1

OSI230330

Ureter forceps
240 mm

Genito-Urinary Instruments



STOCKMANN
OSI230331

Penis clamp
70 mm



STRAUSS
OSI230332

Penis clamp
130 mm



CUNNINGHAM

OSI230333 small
OSI230334 medium
OSI230335 large

Penis clamp



OSI230332
Forceps for grasping the
glans and the foreskin,
ring diam. 4.8 mm
125 mm



OSI230337
Fixation clamp for the
spermatoc cord
145 mm



OSI150111
Hook for the
spermatoc cord
165 mm

Genito-Urinary Instruments



MATHIEU
OSI230302

Foreing body forceps
190 mm
Length of shaft



PITHA

OSI230338
Foreing body forceps
220 mm

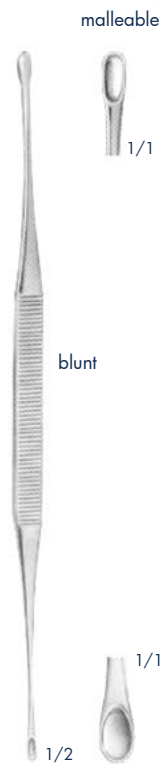

ASCH

OSI240406
Secretion scoop
200 mm



OSI230301
Secretion curette
270 mm

Genito-Urinary Instruments



	Charr. (French)
OSI230339	8
OSI230340	10
OSI230341	12
OSI230342	14
OSI230343	16
OSI230344	18
OSI230345	20

Male catheters,
metal
290 mm

	Charr. (French)
OSI230346	6
OSI230347	8
OSI230348	10
OSI230349	12
OSI230350	14
OSI230351	16
OSI230352	18

Female catheters,
metal
160 mm

OSI230353

Catheter guide
(introducer)
490 mm

GUYON OSI230354

Catheter guide
(introducer)
365 mm

OSI230355

Introducer for
catheters
460 mm

Genito- Urinary Instruments

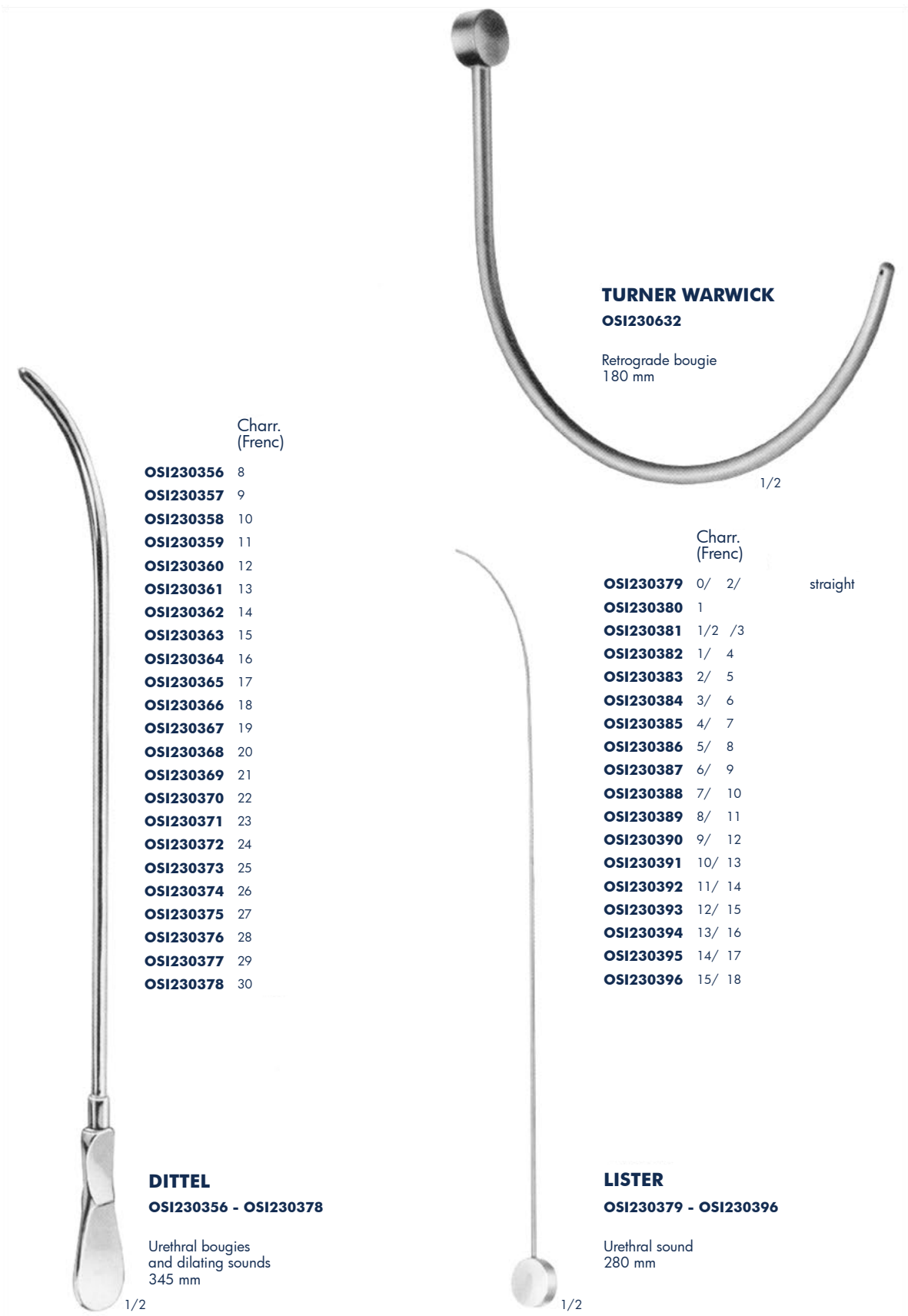

- | | Charr.
(Frenc) |
|------------------|-------------------|
| OSI230356 | 8 |
| OSI230357 | 9 |
| OSI230358 | 10 |
| OSI230359 | 11 |
| OSI230360 | 12 |
| OSI230361 | 13 |
| OSI230362 | 14 |
| OSI230363 | 15 |
| OSI230364 | 16 |
| OSI230365 | 17 |
| OSI230366 | 18 |
| OSI230367 | 19 |
| OSI230368 | 20 |
| OSI230369 | 21 |
| OSI230370 | 22 |
| OSI230371 | 23 |
| OSI230372 | 24 |
| OSI230373 | 25 |
| OSI230374 | 26 |
| OSI230375 | 27 |
| OSI230376 | 28 |
| OSI230377 | 29 |
| OSI230378 | 30 |

DITTEL
OSI230356 - OSI230378

Urethral bougies
and dilating sounds
345 mm

1/2

TURNER WARWICK
OSI230632

Retrograde bougie
180 mm

1/2

Charr.
(Frenc)

- | | |
|------------------|--------|
| OSI230379 | 0/ 2/ |
| OSI230380 | 1 |
| OSI230381 | 1/2 /3 |
| OSI230382 | 1/ 4 |
| OSI230383 | 2/ 5 |
| OSI230384 | 3/ 6 |
| OSI230385 | 4/ 7 |
| OSI230386 | 5/ 8 |
| OSI230387 | 6/ 9 |
| OSI230388 | 7/ 10 |
| OSI230389 | 8/ 11 |
| OSI230390 | 9/ 12 |
| OSI230391 | 10/ 13 |
| OSI230392 | 11/ 14 |
| OSI230393 | 12/ 15 |
| OSI230394 | 13/ 16 |
| OSI230395 | 14/ 17 |
| OSI230396 | 15/ 18 |

straight

LISTER
OSI230379 - OSI230396

Urethral sound
280 mm

1/2

Genito-Urinary Instruments



1/2

GUYON

Urethral bougies and dilating sounds, without filiform guides, with thread in tip 255 mm

- OSI230397** Ben. 24/Charr. 12
- OSI230398** Ben. 26/Charr. 13
- OSI230399** Ben. 28/Charr. 14
- OSI230400** Ben. 30/Charr. 15
- OSI230401** Ben. 32/Charr. 16
- OSI230402** Ben. 34/Charr. 17
- OSI230403** Ben. 36/Charr. 18
- OSI230404** Ben. 38/Charr. 19
- OSI230405** Ben. 40/Charr. 20
- OSI230406** Ben. 42/Charr. 21
- OSI230407** Ben. 44/Charr. 22
- OSI230408** Ben. 46/Charr. 23
- OSI230409** Ben. 48/Charr. 24
- OSI230410** Ben. 50/Charr. 25
- OSI230411** Ben. 52/Charr. 26
- OSI230412** Ben. 54/Charr. 27
- OSI230413** Ben. 56/Charr. 28
- OSI230414** Ben. 58/Charr. 29
- OSI230415** Ben. 60/Charr. 30



1/1

- Charr
- OSI230416** 3
- OSI230417** 4
- OSI230418** 5
- OSI230419** 6

Filiform guides, olive tip for 330 mm

Circumcision Clamps



WINKELMANN

OSI230434 Ø 12 mm

OSI230435 Ø 16 mm

OSI230436 Ø 20 mm

Circumcision clamps

Assisted by two haemostats or ligatures the foreskin is pushed over the bellshaped, protection-rod and the glans is placed into it.

By now, the wing-nut is tightened as close as possible, so the foreskin is annularly compressed. The foreskin is cut off with a scalpel, right next to the compression ring.

The circumcision clamp remains a few minutes to avoid bleeding. In case that any large vein, specially the frenular artery, is cut through, a ligature must be set.

The advantage of the method described is the cosmetically favourable scar which is left after rejection of the small necrotized portion.

Trocars

Luer Lock

KLIMA-ROSEGGER
OSI160460
 35 x 1,8 mm
 Sternal puncture needle

KLIMA-SCHLEICHER
OSI160463 25 x 1,8 mm
 Biopsy needle 25 mm x 15 swg
 for Iliac Crest

OSI160438
 Universal trocar with 4 tips

NELSON

	Inside diam.	Outside diam.
OSI160439	2,2 mm	3,0 mm
OSI160440	3,0 mm	4,0 mm
OSI160441	4,0 mm	5,0 mm
OSI160442	5,0 mm	6,0 mm
OSI160443	5,5 mm	6,5 mm

for hydrocele and abdominal puncture

BUELAU

	Inside diam.	Outside diam.
OSI160444	6,5 mm	8,0 mm
OSI160445	9,0 mm	10,0 mm

Empyema trocar

Trocars

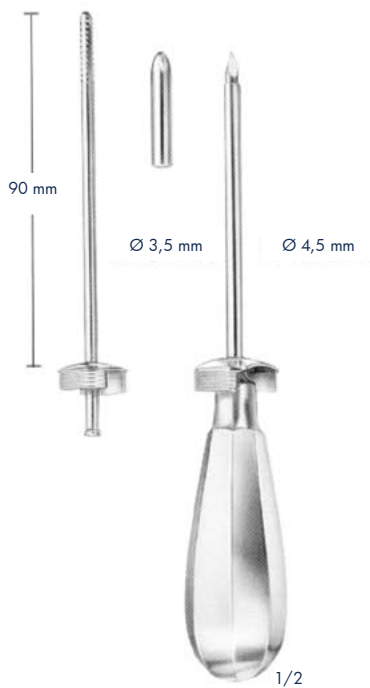

CASTENS

OSI160446

Ascites and hydrocele trocar

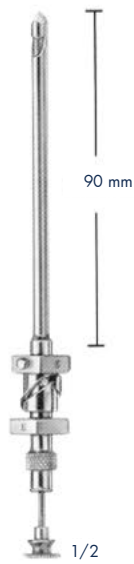

ABRAMS

OSI160447 Ø 4,0 mm

Pleural biopsy punch



OCHSNER

	Inside diam.	Inside diam.
OSI160448	3,0 mm	4,0 mm
OSI160449	3,6 mm	4,6 mm
OSI160450	4,3 mm	5,3 mm
OSI160451	5,0 mm	6,0 mm

Gall bladder trocars

Trocars



Record Cone 1

1/2

PIERCE

OSI160452 Ø 4,0 mm

Antrum trocar
160 mm



Record Cone 1

1/2

KRAUSE

OSI160453 Ø 4,0 mm

Antrum trocar
160 mm



Luer-Lock Cone

1/2

COAKLEY

OSI160454 Ø 3,0 mm

Antrum trocar
140 mm



1/2

1/2

TILLEY

Harpoon trocar
170 mm

Vaginal Specula

Vaginal Specula

How to measure vaginal specula

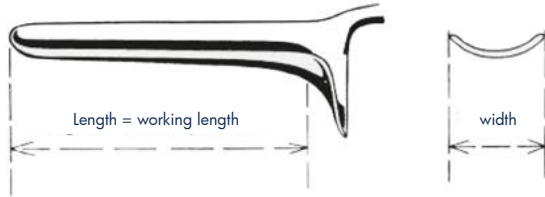

COLLIN
OSI240101
53 x 10 mm
for children



COLLIN
OSI240116
95/85 x 18 mm
for virgins

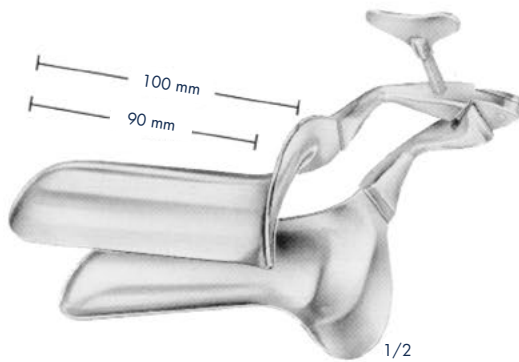

COLLIN

OSI240117	100/90 mm	28 mm
OSI240118	100/90 mm	32 mm
OSI240119	105/95 mm	35 mm
OSI240120	115/105 mm	40 mm
Total length/working length		width

Vaginal Specula



1/2

CUSCO
OSI240109
 75 x 17 mm
 for virgins

Swiss patterns
 features: long and narrow



1/2

CUSCO
OSI240478
 75 x 17 mm
 for virgins

flat (duck beak)



1/2

CUSCO
OSI240479 92 x 23 - 25 mm
OSI240480 100 x 25 - 27 mm
OSI240481 110 x 27 - 30 mm



1/2

CUSCO
OSI240110 80 x 32 mm
OSI240111 90 x 37 mm
OSI240112 115 x 37 mm

Vaginal Specula



1/2

CUSCO STANDARD

- OSI240105** 80 x 24 mm
- OSI240108** 80 x 32 mm
- OSI240106** 90 x 36 mm
- OSI240107** 110 x 37 mm



1/2

CUSCO

- OSI240482** 80 x 24 mm
- OSI240113** 80 x 32 mm
- OSI240114** 90 x 36 mm
- OSI240115** 110 x 37 mm



1/2

CUSCO

- OSI240483** 107 x 29 mm
- OSI240484** 115 x 35 mm

With suction-tube, to use with laser

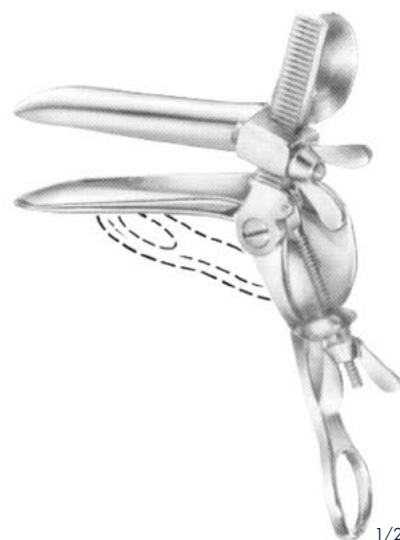

1/2

TRELAT

- OSI240121** 85 x 33 mm
- OSI240122** 95 x 35 mm
- OSI240123** 115 x 43 mm

Vaginal Specula

SEYFFERT

OSI240485 100 x 17 mm
OSI240486 110 x 33 mm

230 mm



One side open for taking up
instruments and catheters

SEYFFERT

OSI240487

110 x 33 mm

230 mm



With double ratchet, closing and
opening of ratchet by pressure of thumb

SEMM

OSI240488

90 x 14 - 18 mm

for children and virgins
180mm



With double ratchet, closing and
opening of ratchet by pressure of thumb

SEMM

OSI240489

100 x 17 - 20 mm

OSI240490
100 x 25 - 30 mm
185 mm



Vaginal Specula



GRAVE

- OSI240102** 75 x 20 mm
- OSI240103** 95 x 30 mm
- OSI240104** 105 x 33 mm

1/2



PEDERSON

- OSI240125** 100 x 22 mm
- OSI240126** 120 x 25 mm

1/2



BREISKY

- OSI240491** 72 x 25 mm / 77 x 30 mm
140 mm
- OSI240492** 75 x 30 mm / 92 x 38 mm
170 mm

1/2



SIMS

- OSI240136** 70 x 26 mm / 75 x 30 mm
125 mm
- OSI240137** 75 x 30 mm / 80 x 35 mm
150 mm
- OSI240138** 80 x 36 mm / 90 x 40 mm
175 mm

1/2

Vaginal Specula - Sets, upper and lower Blades

SEIDEL

- OSI240493** 80 x 8 mm
- OSI240494** 80 x 10 mm
- OSI240495** 90 x 14 mm

for children and infants
170 mm



KRISTELLER

- OSI240496** 70 x 15 mm

for children
170 mm



KRISTELLER

- OSI240151** 70 x 27 mm
- OSI240152** 75 x 30 mm
- OSI240153** 90 x 36 mm

175 mm

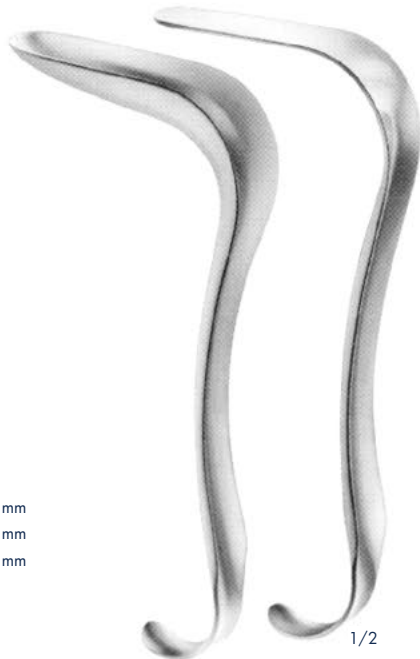

KRISTELLER

- OSI240497** 110 x 18 mm
- OSI240498** 110 x 20 mm
- OSI240499** 110 x 27 mm
- OSI240500** 110 x 30 mm
- OSI240501** 110 x 36 mm

220 mm



Vaginal Specula - upper and lower Blades

KRISTELLER
OSI240502 - OSI240129
 lower blades



KRISTELLER
OSI240503 - OSI240132
 upper blades



OSI240502
 70 x 15 mm
 175 mm



OSI240503
 75 x 10 mm
 175 mm



OSI240127
 70 x 27 mm
 180 mm



OSI240130
 75 x 23 mm
 180 mm



OSI240128
 75 x 30 mm
 180 mm



OSI240131
 80 x 25 mm
 180 mm



OSI240129
 90 x 36 mm
 185 mm



OSI240132
 100 x 32 mm
 185 mm



1/2

1/2

Vaginal Specula - upper and lower Blades

KRISTELLER
OSI240504 - OSI240508
 lower blades



KRISTELLER
OSI240509 - OSI240513
 upper blades



OSI240504
 110 x 18 mm
 215 mm



OSI240509
 115 x 14 mm
 215 mm



OSI240505
 110 x 27 mm
 215 mm

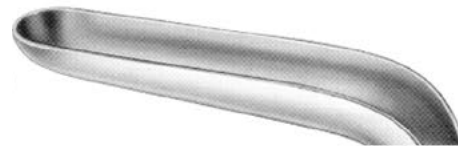

OSI240510
 115 x 23 mm
 215 mm



OSI240506
 110 x 20 mm
 220 mm



OSI240511
 115 x 16 mm
 220 mm



OSI240507
 110 x 30 mm
 220 mm



OSI240512
 115 x 26 mm
 220 mm



OSI240508
 110 x 36 mm
 225 mm



OSI240513
 120 x 30 mm
 225 mm



1/2

1/2

Vaginal Specula - upper blades, suitable for the Vario Retractor System



Upper blades, to use with handles **OSI150674** and **OSI150673**
connecting to **KRISTELLER** vaginal specula

OSI240514	110 x 14 mm	OSI240504
OSI240515	110 x 23 mm	OSI240505
OSI240516	110 x 16 mm	OSI240506
OSI240517	110 x 26 mm	OSI240507
OSI240518	115 x 30 mm	OSI240508

See back page

Vario Retractor System

Vario retractor system with integrated cold light, for additional intensive illumination of deep and complicated operation fields.



OSI150673

Handle with cold light carrier
for upper blades
280mm

OSI150674

Handle with cold light carrier
for upper blades
180 mm

Handle arrangement variable

Vaginal Specula

KALLMORGEN

OSI240519

75 x 39 mm
170 mm



1/2

KALLMORGEN

OSI240520

75 x 39 mm
Set
170 mm



1/2

KALLMORGEN

OSI240521

95 x 39 mm
Set
200 mm

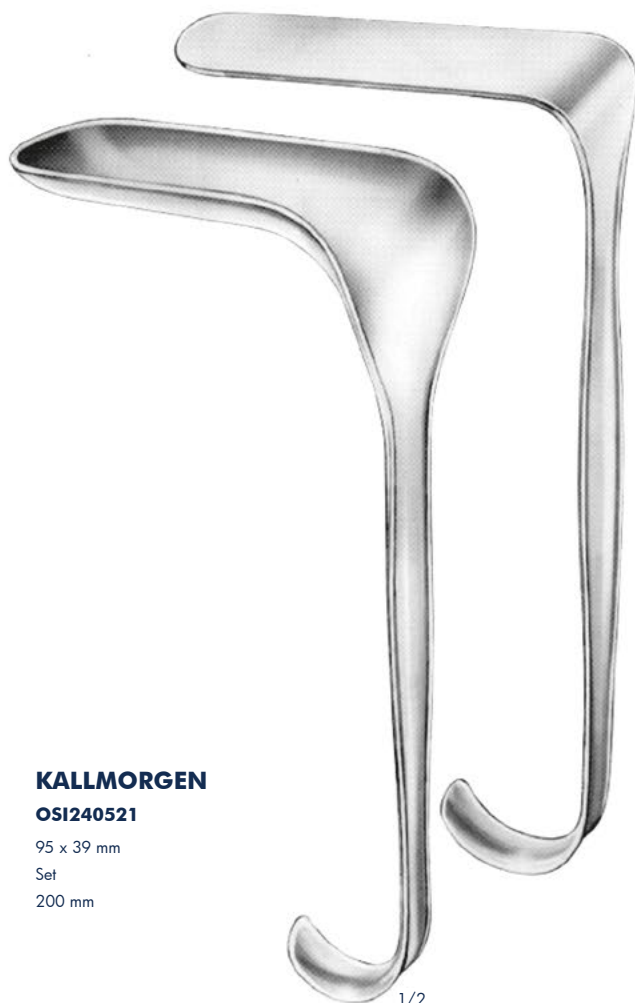

1/2

Vaginal Specula

KRISTELLER VIENNA PATTERN

Sets

OSI240522 110 x 20 mm

OSI240523 110 x 30 mm

OSI240524 110 x 36 mm

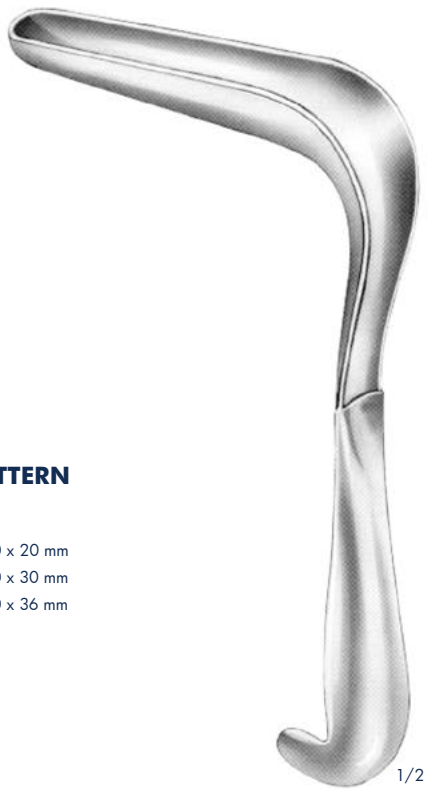

OSI240525

110 x 20 mm

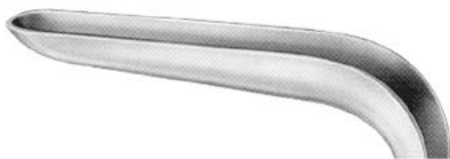

OSI240526

110 x 30 mm



OSI240527

110 x 36 mm



OSI240528

115 x 18 mm



OSI240529

115 x 26 mm



OSI240530

115 x 32 mm



OSI240525 - OSI240527

lower blades
215 mm

OSI240528 - OSI240530

upper blades
220 mm

Vaginal Specula for Children and Virgins



BRAUN
OSI240531
180 mm



BRAUN
OSI240160
180 mm



MATHIEU
OSI240172
for children and virgins
210 mm



MATHIEU
OSI240174
for children and virgins fitting
210 mm

Vaginal Specula

slightly concave



KRISTELLER
OSI240532 - OSI240534
205 mm

slightly concave



JACKSON
OSI240142 - OSI240144
175 mm

OSI240532
80 x 28 mm



OSI240142
76 x 38 mm



OSI240533
85 x 35 mm



OSI240143
89 x 38 mm



OSI240534
85 x 40 mm



OSI240144
102 x 38 mm



1/2

1/2

1/2

1/2

Vaginal Specula

OSI240535
60 x 45 mm



OSI240536
90 x 45 mm



OSI240537
112 x 45 mm

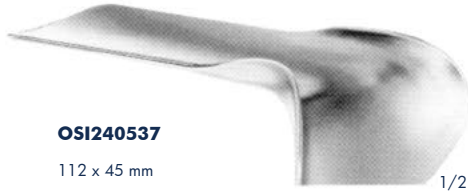

DOYEN
OSI240535 - OSI240537
235 mm

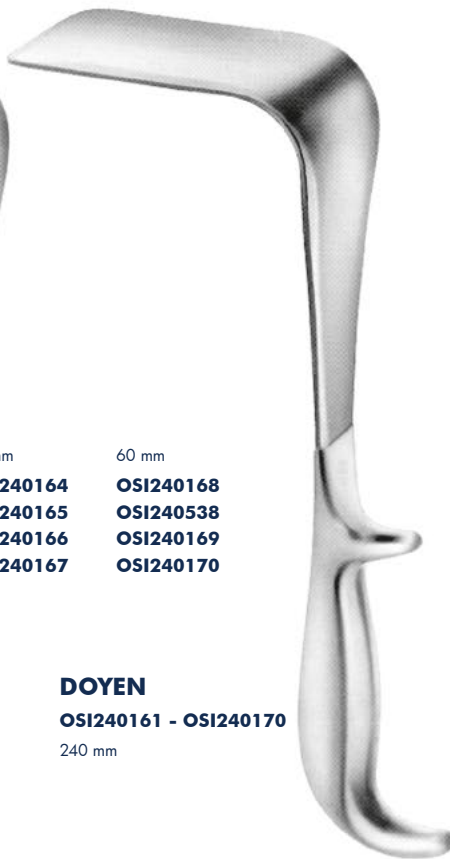
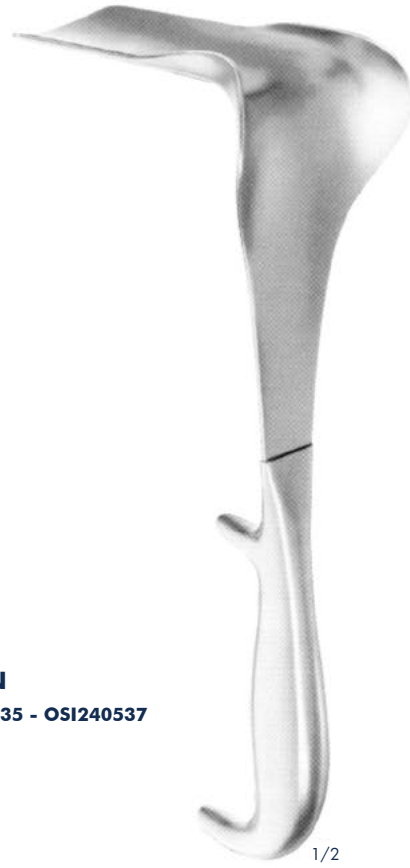

Length of blades

Width of blades

	35 mm	45 mm	60 mm
60 mm	OSI240161	OSI240164	OSI240168
90 mm	OSI240162	OSI240165	OSI240538
120 mm	OSI240163	OSI240166	OSI240169
160 mm	-	OSI240167	OSI240170

DOYEN
OSI240161 - OSI240170
240 mm

LANDON
OSI240539 89 x 25 mm
195 mm

Vaginal Specula



1/2

LANDAU

OSI240188 100 x 28 mm

OSI240189 110 x 38 mm

290 mm



1/2

BREISKY

VIENNA PATTERN

OSI240177 100 x 20 mm

OSI240178 100 x 25 mm

OSI240179 100 x 30 mm

OSI240180 100 x 35 mm

OSI240181 100 x 40 mm

300 mm



1/2

BREISKY

VIENNA PATTERN

OSI240182 130 x 20 mm

OSI240183 130 x 25 mm

OSI240184 130 x 30 mm

OSI240185 130 x 35 mm

OSI240186 130 x 40 mm

320 mm



1/2

BREISKY

VIENNA PATTERN

OSI240187 160 x 40 mm

OSI240540 180 x 40 mm

350 mm

Vaginal and Wound Retractors



WEISSBARTH

OSI240541 80 x 28 mm

OSI240542 85 x 42 mm

210 mm

OSI240543

removable strainer only

1/2



DOYEN

OSI240544

60 x 30 mm

lateral speculum

230 mm

1/2



DOYEN

OSI240176

80 x 30 mm

lateral speculum

250 mm

1/2

Vaginal and Wound Retractors

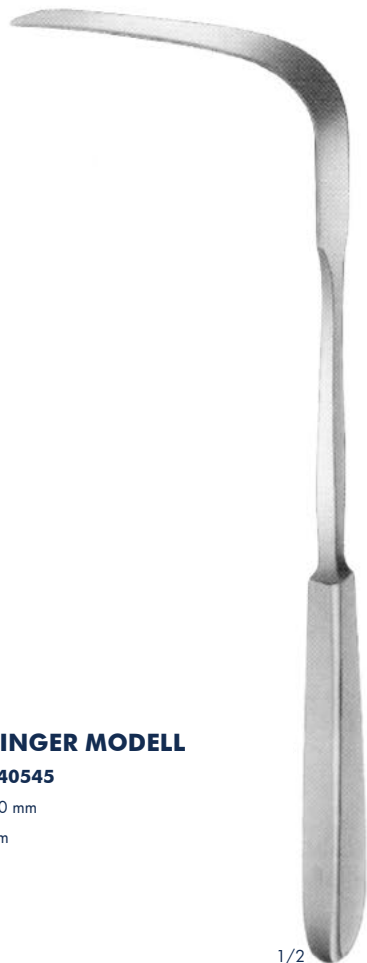

TUBINGER MODELL
OSI240545
95 x 20 mm
265 mm

1/2

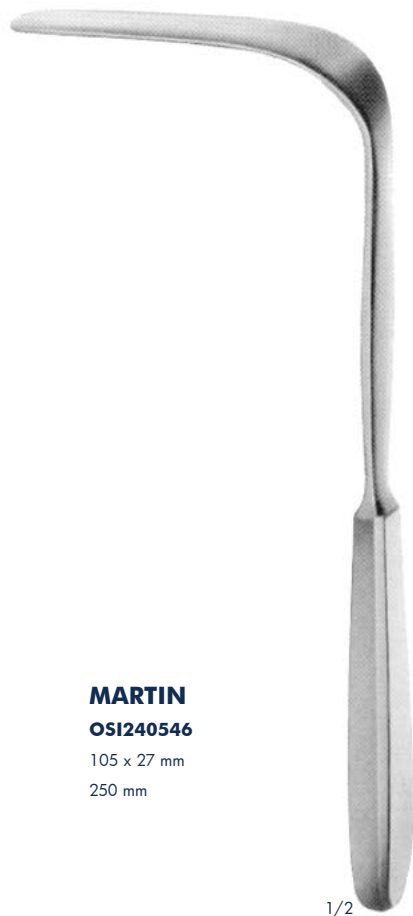

MARTIN
OSI240546
105 x 27 mm
250 mm

1/2



SIMON
OSI150265
115 x 22 mm
275 mm

1/2



SIMON
OSI150264
115 x 26 mm
275 mm

1/2

Vaginal Specula

AUVARD

OSI240547

65 x 38 - 28 mm
 1,530 kg = 3 lbs. 6 oz.
 with detachable weight
 230 mm



AUVARD

OSI240175 75 x 42 - 40 mm

OSI240548 105 x 43 - 40 mm

1,470 kg = 3 lbs. 4 oz.
 with detachable weight
 230 mm

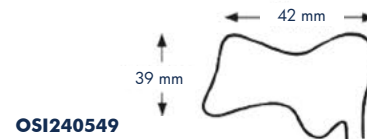
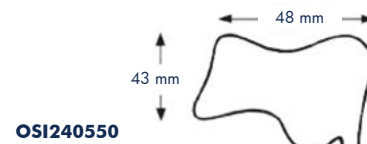
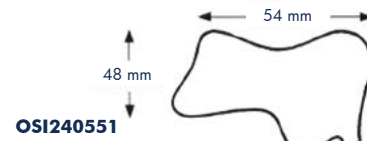
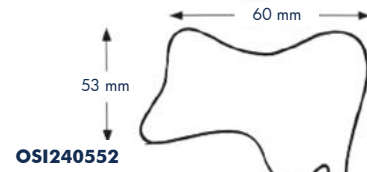
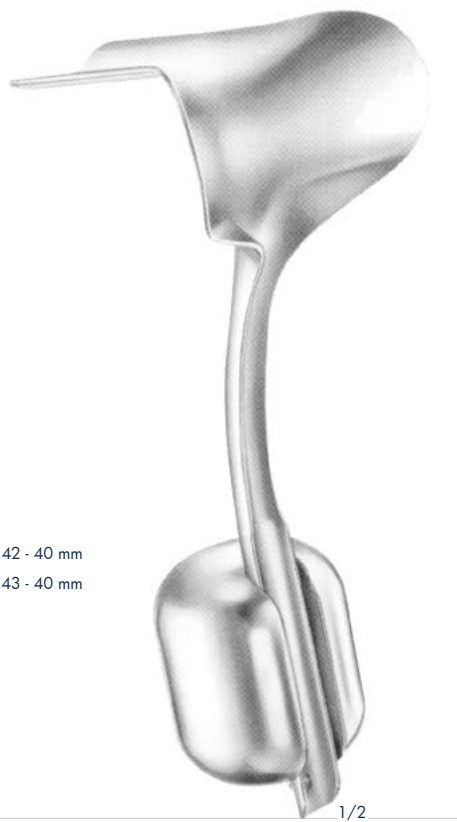

MARTIN

OSI240549 - OSI240552

with hook-shaped handle
 for hanging-in weights
 270 mm



Vaginal Specula



OSI240554
80 x 30 mm



OSI240555
85 x 35 mm



OSI240556
85 x 40 mm

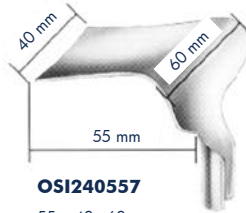

OSI240557
55 x 40 - 60 mm

OSI240558
70 x 45 - 70 mm

OSI240559
80 x 45 - 70 mm



OSI240561

OSI240560

1/2

SCHERBACK OSI240553

Set, consisting of

Handle **OSI240561**

Weight **OSI240560**

4 Blades **(OSI240554 - OSI240557)**

The mentioned blades **OSI240554 - OSI240559** and **OSI240562 - OSI240569** can be exchanged. They fit handle **OSI240561** as well as handles **OSI240571** and **OSI240572**



OSI240556
80 x 30 mm



OSI240562
65 x 30 mm



OSI240567
85 x 33 mm



OSI240563
75 x 35 mm



OSI240568
100 x 38 mm

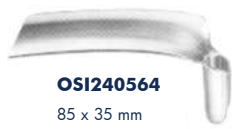

OSI240564
85 x 35 mm



OSI240569
110 x 42 mm



OSI240565
95 x 35 mm



1/2

BOZEMANN OSI240570

Set, consisting of:

2 handles **(OSI240571 - OSI240572)**

8 blades **(OSI240562 - OSI240569)**

OSI240571
230 mm

OSI240572
220 mm

Vaginal Retractor



JOLL (FRIEDMAN)
OSI150764
155 mm



RICHTER
OSI150766
170 mm



GELPI
OSI150390
135 mm



GELPI
OSI150391
175 mm

Uterine Dilators



HEGAR

OSI240194 - OSI240236

with very conical point
185 mm

OSI240194	1 mm
OSI240195	2 mm
OSI240196	3 mm
OSI240197	4 mm
OSI240198	5 mm
OSI240199	6 mm
OSI240200	7 mm
OSI240201	8 mm
OSI240202	9 mm
OSI240203	10 mm
OSI240204	11 mm
OSI240205	12 mm
OSI240206	13 mm

OSI240207	14 mm
OSI240208	15 mm
OSI240209	16 mm
OSI240210	17 mm
OSI240211	18 mm
OSI240212	19 mm
OSI240213	20 mm
OSI240214	21 mm
OSI240215	22 mm
OSI240216	23 mm
OSI240217	24 mm
OSI240218	25 mm
OSI240219	26 mm

OSI240220	1 1/2 mm
OSI240221	2 1/2 mm
OSI240222	3 1/2 mm
OSI240223	4 1/2 mm
OSI240224	5 1/2 mm
OSI240225	6 1/2 mm
OSI240226	7 1/2 mm
OSI240227	8 1/2 mm
OSI240228	9 1/2 mm
OSI240229	10 1/2 mm
OSI240230	11 1/2 mm
OSI240231	12 1/2 mm
OSI240232	13 1/2 mm

OSI240233	14 1/2 mm
OSI240234	15 1/2 mm
OSI240235	16 1/2 mm
OSI240236	17 1/2 mm

HAWKIN-AMBLER

OSI240573 - OSI240584

175 mm



OSI240573	3/6 mm
OSI240574	4/7 mm
OSI240575	5/8 mm
OSI240576	6/9 mm
OSI240577	7/10 mm
OSI240578	8/11 mm
OSI240579	9/12 mm
OSI240580	10/13 mm
OSI240581	11/14 mm
OSI240582	12/15 mm
OSI240583	13/16 mm
OSI240584	14/17 mm

HEGAR

OSI240585 - OSI240593

205 mm



OSI240585	1 + 2 mm
OSI240586	3 + 4 mm
OSI240587	5 + 6 mm
OSI240588	7 + 8 mm
OSI240589	9 + 10 mm
OSI240590	11 + 12 mm
OSI240591	13 + 14 mm
OSI240592	15 + 16 mm
OSI240593	17 + 18 mm

HEGAR

OSI240682

Uterine dilator set, in canvas roll
with 8 dilators (**OSI240586 - OSI240593**)



set of:
OSI240725 (14 piece)
(**OSI240197 - OSI240210**)

set of:
OSI240726 (14 piece)
(**OSI240223 - OSI240236**)

set of:
OSI240727 (28 piece)
(**OSI240197 - OSI240210**) + (**OSI240223 - OSI240236**)

Endospecula for Cervix



KOGAN
OSI240192
Endospecula for cervix and urethra,
without ratchet
240 mm

KOGAN
OSI240193
Endospecula for cervix and urethra,
with scale-ratchet and fixing screws
240 mm

Uterine Probes

5 mm



1/2

MAYO
OSI240594
malleable
330 mm

4 mm



1/2

SIMS
OSI240237
330 mm
OSI240238
malleable
330 mm



GALABINS
OSI240595
295 mm
Shaft graduated
in cm's
malleable

3 mm



1/2

MARTIN
OSI240239
300 mm

4 mm



1/2

VALLEIX
OSI240596
graduated
with slider
250 mm

4 mm



1/2

SIMPSON
OSI240597
malleable,
silver-plated
310 mm

Cotton and Caustic Holder, Tampon Instruments



BRAUN
OSI240241
Uterine depressor
270 mm

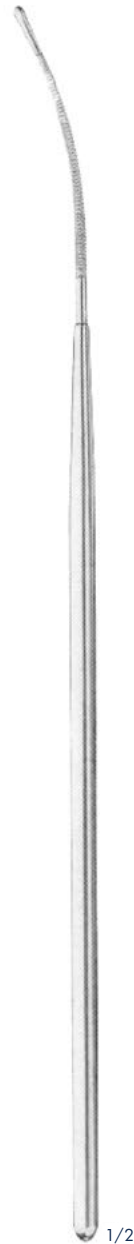

PLAYFAIR
OSI240598
Cotton-and
caustic holder
320 mm



AMANN
OSI240599
Uterine gauze packer
320 mm

Uterine Dressing Forceps



PELKMANN
OS1240600
260 mm

PELKMANN
OS1240601
260 mm

BOZEMANN
OS1240602
250 mm

BOZEMANN
OS1240603
255 mm
Jaws with longitudinal groove

Uterine Dressing Forceps



Uterine Tenaculum Forceps



BERNHARD
OSI130353
160 mm



POZZI
OSI240607
175 mm

Uterine Dressing Forceps



BRAUN
OSI240246
slender pattern
250 mm



COLLIN-POZZI
OSI240608
250 mm

Uterine Tenaculum Forceps

STANDARD



SCHRÖDER
OSI240245
250 mm



SCHRÖDER
OSI240609
250 mm

Uterine Tenaculum Forceps



MARTIN
OSI240611
265 mm

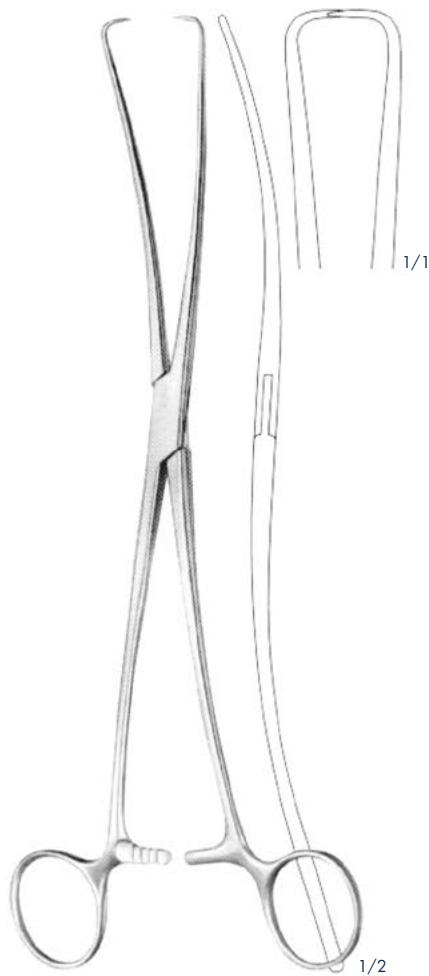

DUPLAY
OSI240247
250 mm

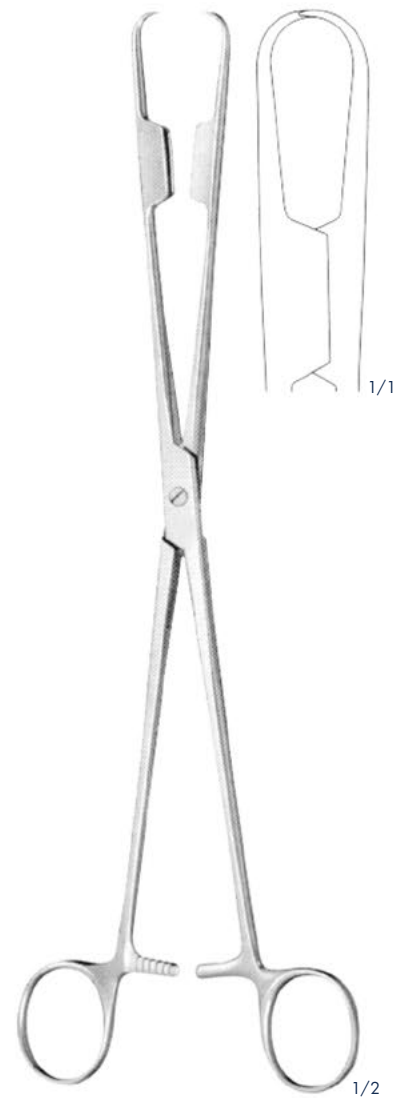

ABEL
OSI240249
280 mm

Uterine Tenaculum Forceps

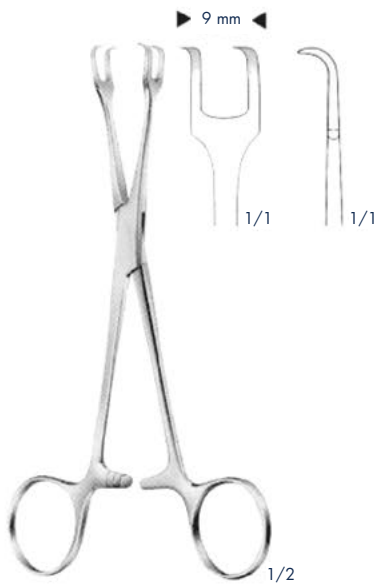

LAHEY
OSI140163
155 mm

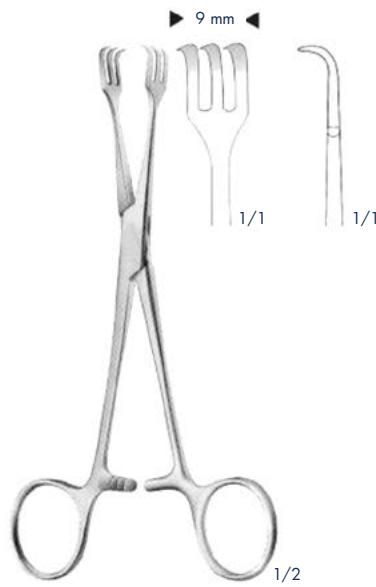

LAHEY
OSI220134
155 mm

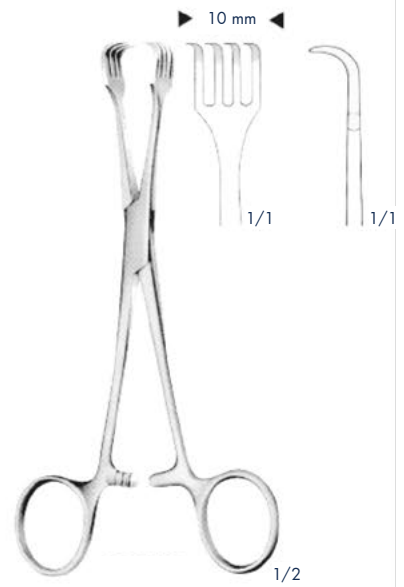

BRAUN
OSI240262
155 mm

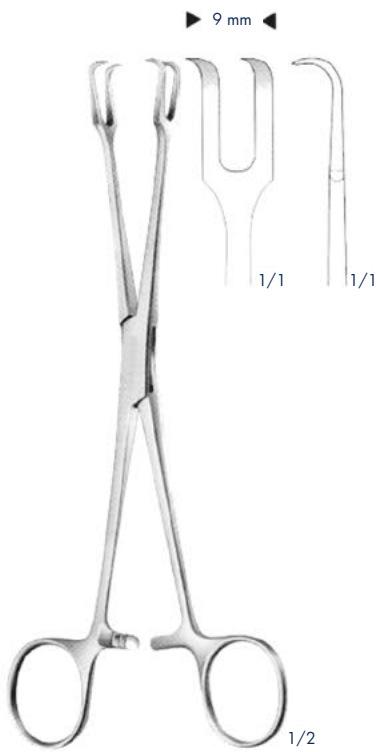

MUSEUX
OSI240612
200 mm

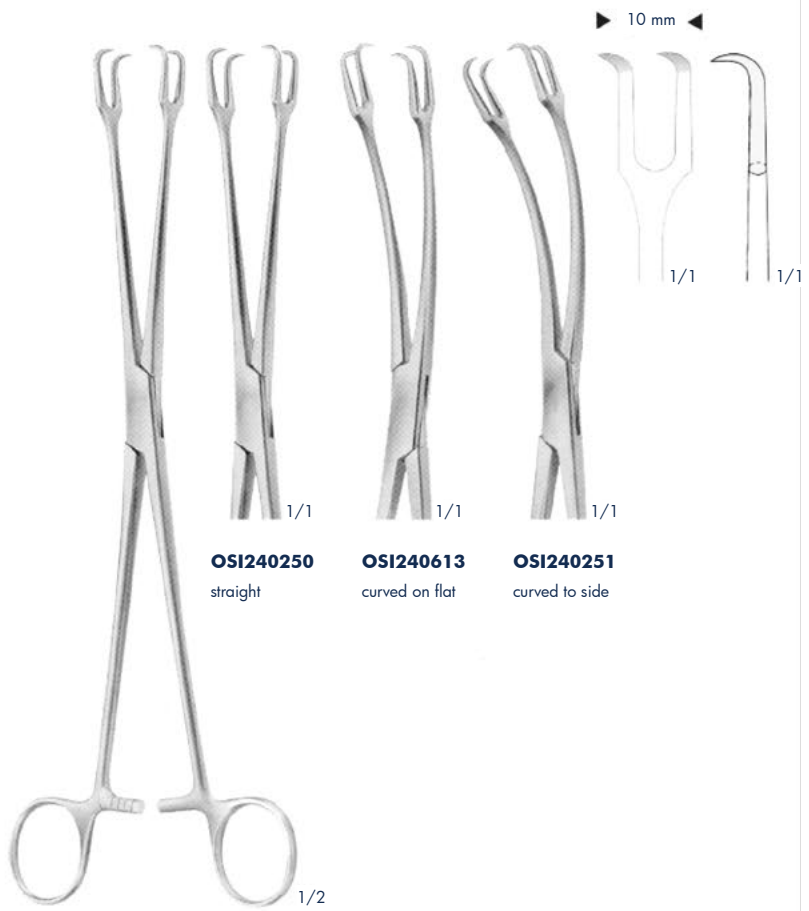

SCHRÖDER
OSI240250 - OSI240251
250 mm

Uterine Tenaculum Forceps

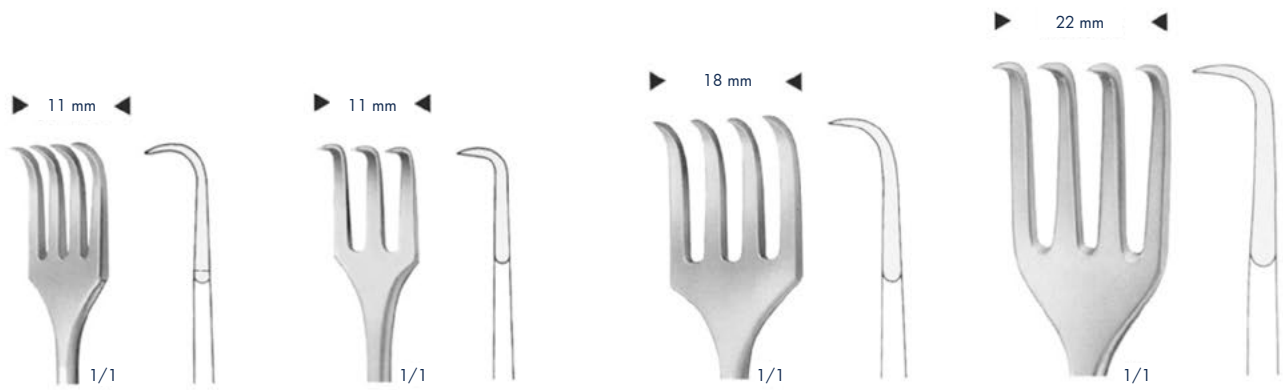

CZERNY
OSI240263
 200 mm

SCHRÖDER
OSI240614
 270 mm

OSI240261
 260 mm

PRATT
OSI240615
 270 mm

Uterine Tenaculum Forceps



KÜSTNER
OSI240616
250 mm



TEALE
OSI240617
3 x 4 teeth
180 mm

Uterine Tenaculum Forceps



TEALE
OSI240618
225 mm



JACOBS
OSI240259
215 mm

Uterine Tenaculum Forceps

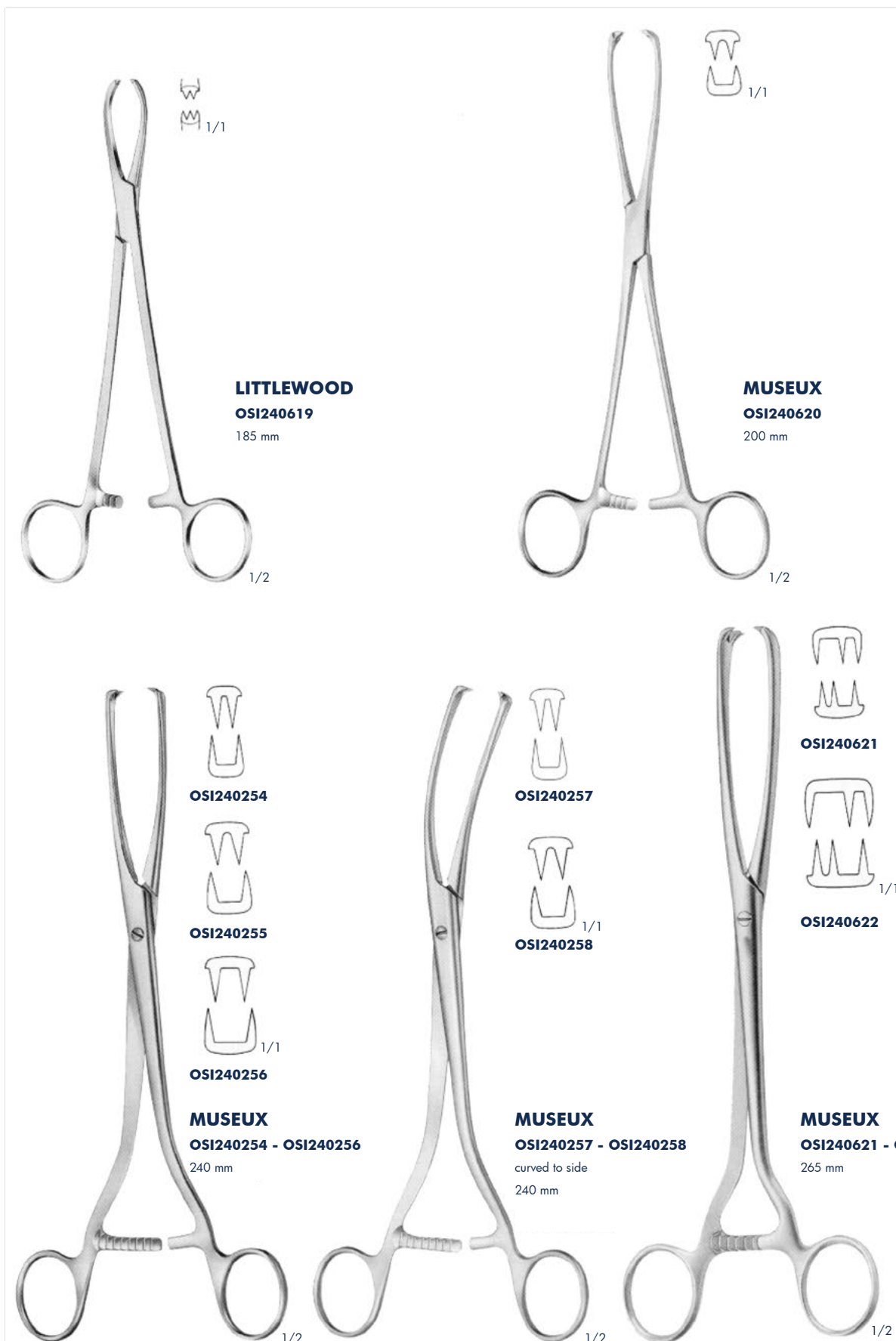

Polypus and Ovum Forceps



1/1

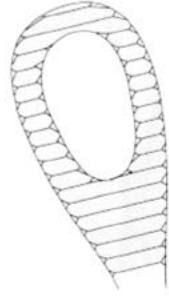

1/1



1/1



1/1



1/2

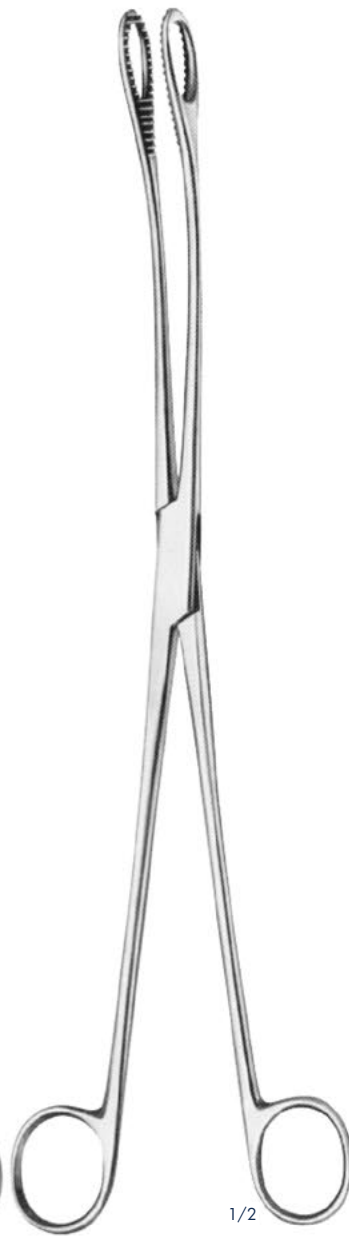

1/2

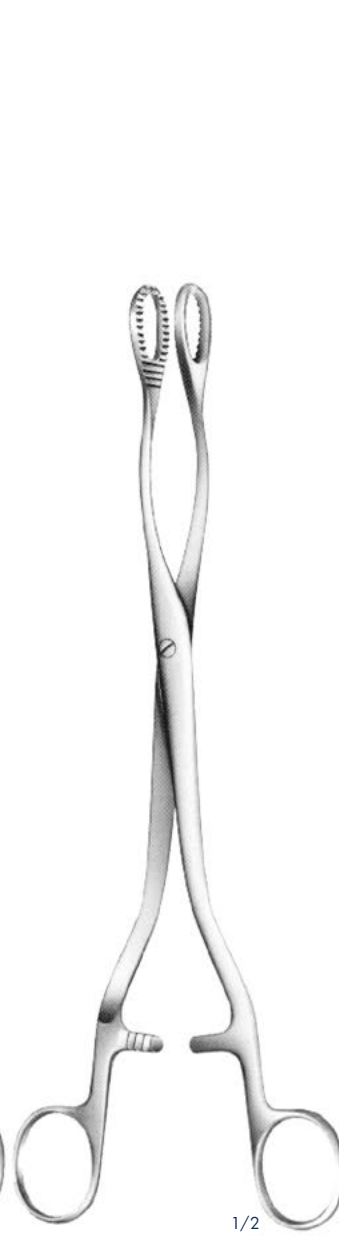

1/2

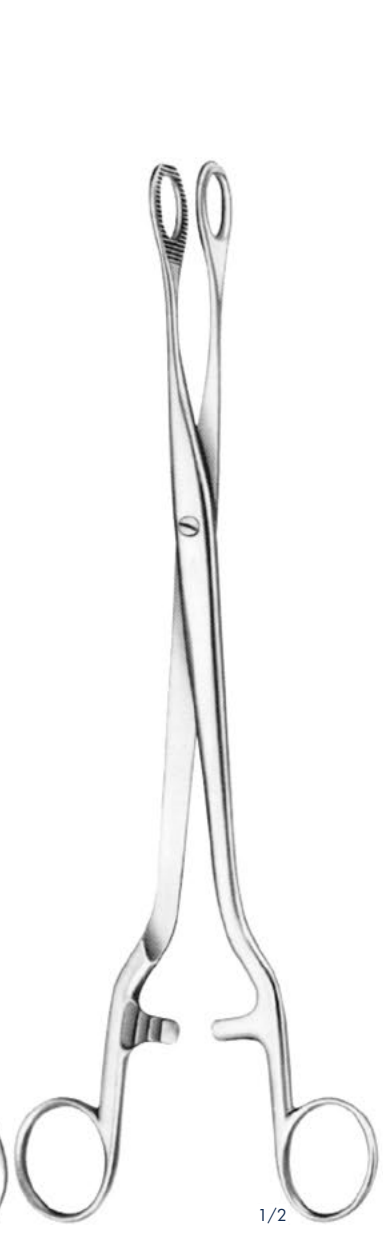

1/2

HEYWOOD-SMITH
OSI230232
200 mm

KELLY
OSI240264
320 mm

HEYWOOD-SMITH
OSI240623
250 mm

NOTO
OSI240265
280 mm

Polypus and Ovum Forceps

ATRAUMATIC

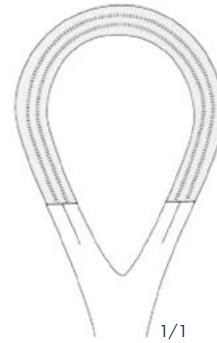

DOYEN
OSI240266
185 mm



OSI130127 250 mm
OSI130128 270 mm

Polypus and Ovum Forceps



1/1

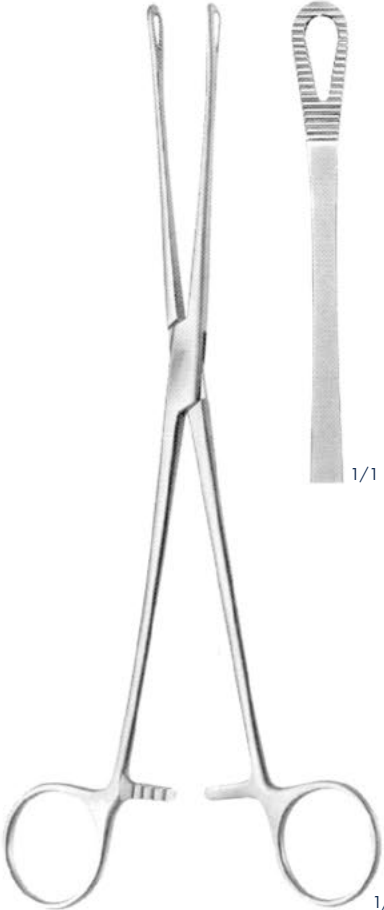

1/1

1/2

BONNEY
OSI240624
240 mm

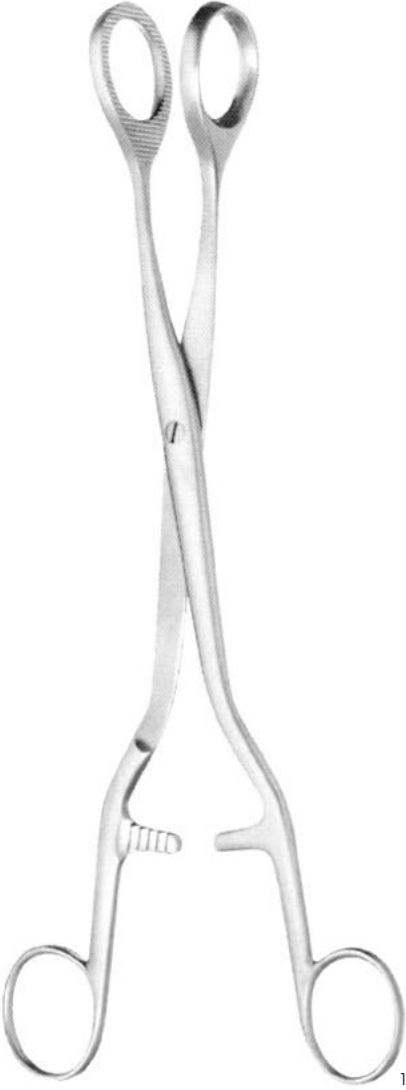

1/2

BUMM
OSI240625
280 mm

Uterine Elevating Forceps



COLLIN
OSI240626
250 mm



COLLIN
OSI240627
285 mm

Uterine Elevating Forceps



DARTIGUES
OSI240270
255 mm



SOMER
OSI240271
235 mm

Uterine Elevating Forceps



COLLIN
OSI240272
265 mm



OSI240628
ca. 260 mm
approx.

Myoma Instruments



SEGOND
OSI240269
Myomatome
270 mm



DOYEN
OSI240268
Myoma screw
150 mm



DOYEN
OSI240267
Myoma screw
190 mm

Instruments for Micro Tubal Operations



NEUBÜSER
OSI240629 - OSI240631
Tubal seizing forceps
200 mm



OSI240632
Splint guide with thread



OSI240633
Splint guide with round handle
180 mm



OSI240634
Angled glass rods
SZ = set of 3 pieces

Modified Instruments for Radical Hysterectomy



1/2

UCHIDA (MODIF. N. BURKE)

OS1240636

Spoon
270 mm

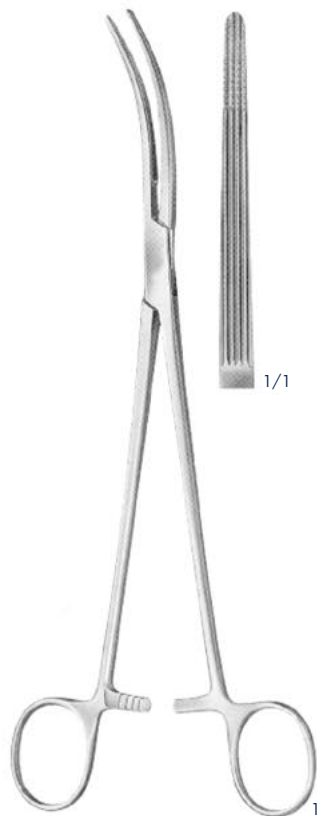

1/1

1/2

KIEBACK

OS1130523

Ureteral tunnel clamp, curved to side
235 mm

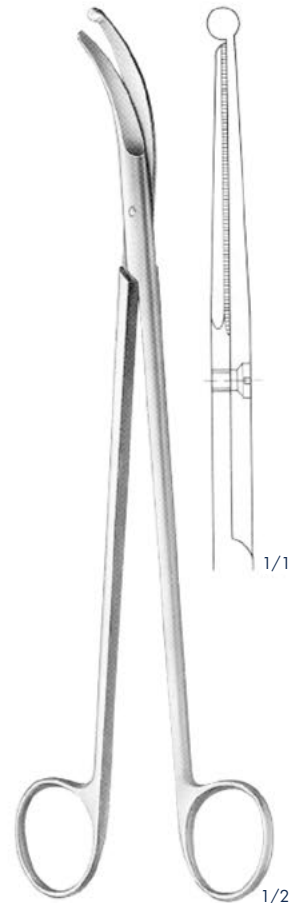

1/1

1/2

KIEBACK

OS1110693

Parametrium scissors,
with ball-point, curved to side
260 mm

Modified Instruments for Radical Hysterectomy



BURKE
OS1130558

Parametrium clamp, short jaw part
250 mm



BURKE
OS1130559

Parametrium clamp, long jaw part
250 mm



KIEBACK
OS1110692

Parametrium scissors
240 mm

For further details refer to our leaflet

Cutting Cylinder for Drill Biopsy



MODELL ERLANGEN

OSI240403

Cutting cylinder for drill biopsy
125 mm



MODELL ERLANGEN

OSI240404

Cutting cylinder for drill biopsy
180 mm

Cone Knives for "Ring" -Biopsy



Biopsy Curettes Removing hook



SAUNDERS
OSI240405
Removing hook
320 mm

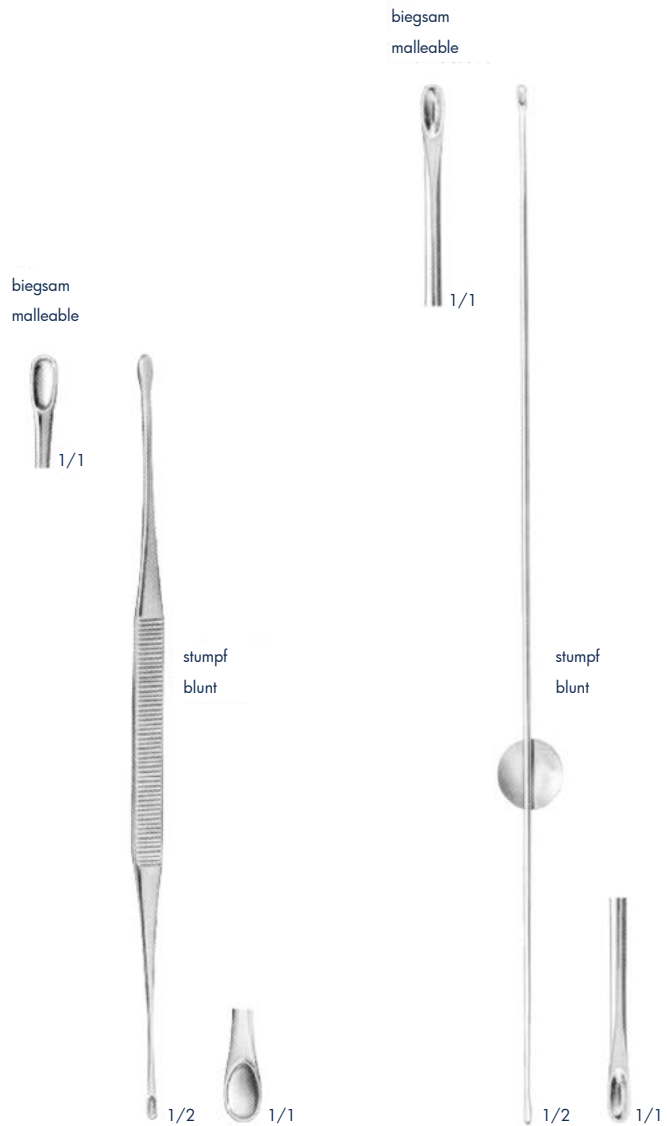

ASCH
OSI240406
Uterine secretion scoop
200 mm

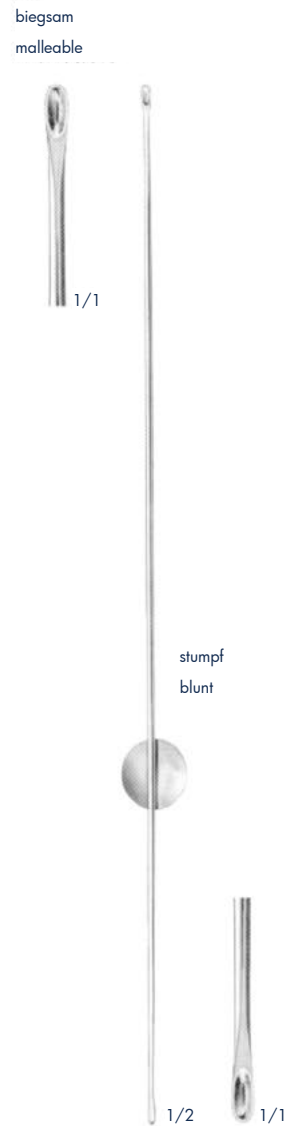

OSI230301
Uterine secretion scoop
270 mm

Biopsy Curettes



NOVAK-SCHOECKAERT

OSI240277

Endometrial biopsy curette
240 mm



RANDALL

OSI240276

Endometrial biopsy curette
240 mm

Biopsy Curettes



MOD, BERLIN
OSI240407
 Endometrial biopsy curette
 270 mm

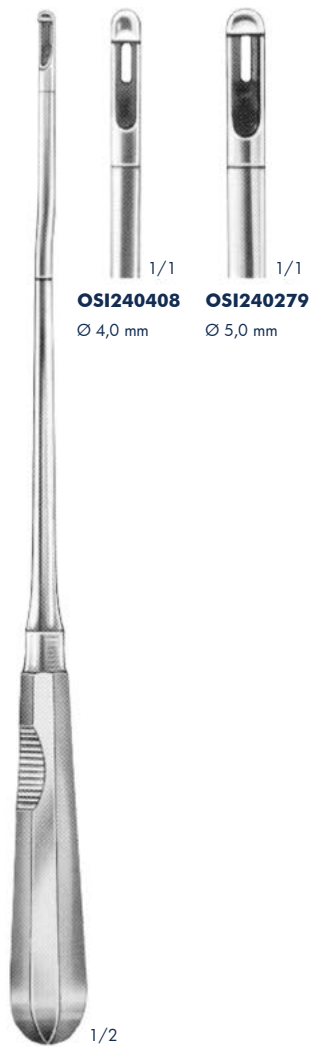

MOD, MÜNCHEN
OSI240408 - OSI240279
 Endometrial biopsy curettes
 270 mm



GUSBERG
OSI240409 - OSI240411
 Endocervical biopsy curettes
 240 mm

Biopsy Forceps

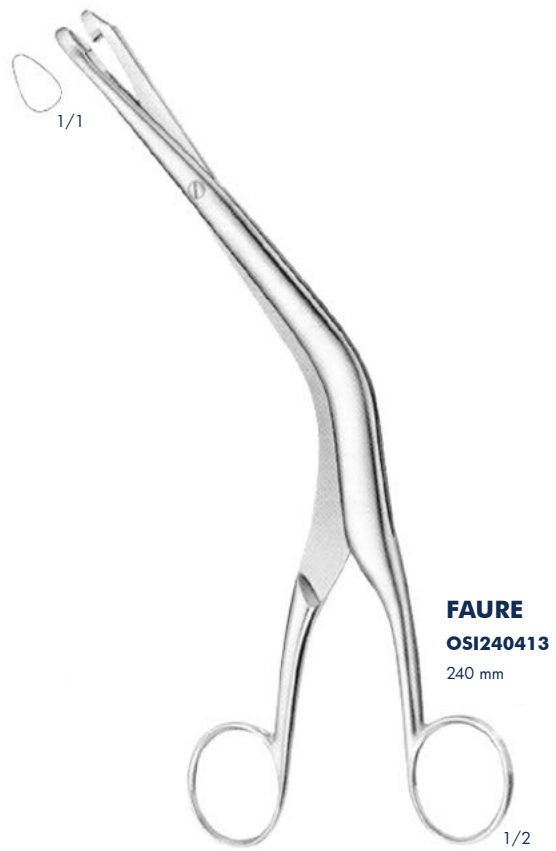

Biopsy Forceps

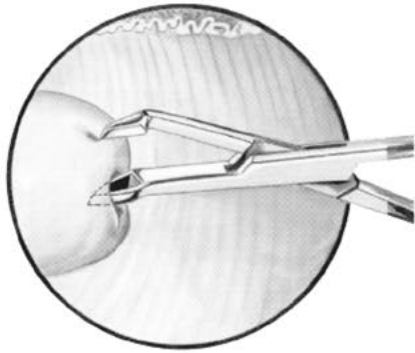

Forceps applied to the portio vaginalis uteri. The excellent hooking effect can be seen.

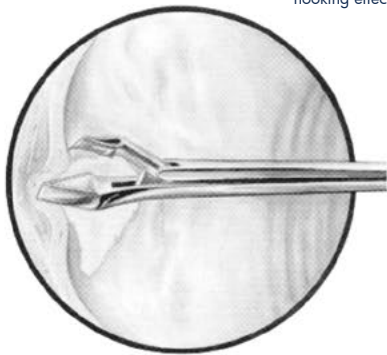

Forceps applied to cicatricially altered flat vaginal vault.



1/1
OSI240414



1/1
OSI240415



1/2

SCHUMACHER
OSI240414 - OSI240415
240 mm

Advantages of the Schumacher forceps:
More reliable grip on the tissue due to new "hooking" effect.
Wide angle of opening. Smooth, steady cut. Specimens are not squashed.
Not painful; self-sealing wound, heals well.



1/1 **OSI240290**

1/1 **OSI240291**



1/2

SCHUMACHER
OSI240290 - OSI240291
suitable for colposcopy

Biopsy Forceps

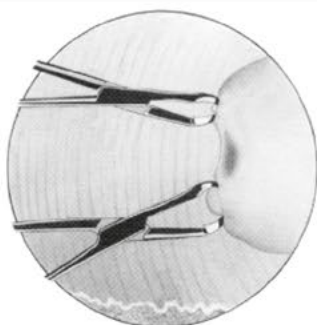

The size of the biopsy is determined by the opening angle of the forceps. The hook effect of the curved jaws allows tissue removal and an additional hook forceps is hardly ever necessary.

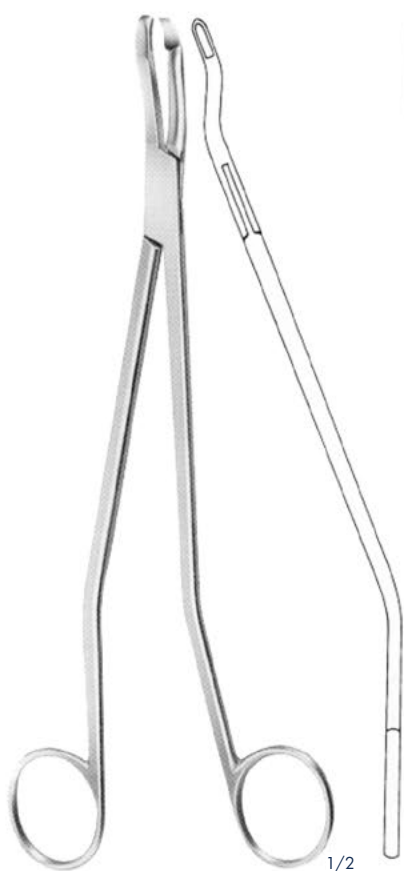

SEIDL DBP

- OSI240416** 2,0 mm
- OSI240417** 2,4 mm
- OSI240418** 2,4 mm

Biopsie forceps, bayonet-shaped, for portio, vagina and vulva
240 mm

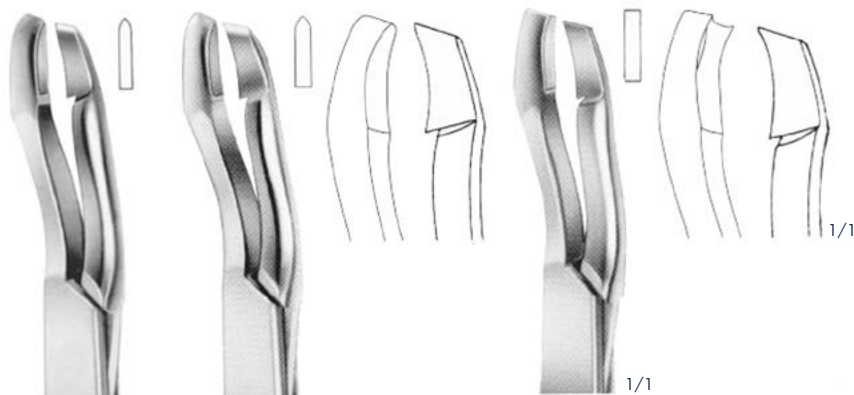

OSI240416
2,0 mm

OSI240417
2,4 mm

OSI240418
2,4 mm

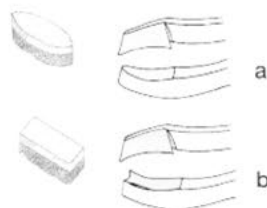

2 different shapes of the jaw are available:

- a) gothic shape
(causes less bleeding)

- b) rectangular shape, 2,4 mm wide

The smooth vertical cut through the epithelium and fibrous tissue allows an immediate histological examination. The biopsy is laterally fixed to a plane support (e.g. cork) and can thus properly be embedded for intersection. No tangential incisions.

The bayonet-shape of the forceps does neither obstruct the view to the portio nor to the area of biopsy, no matter whether a colposcope is used or not. Application of the forceps can be well controlled.

Biopsy Forceps

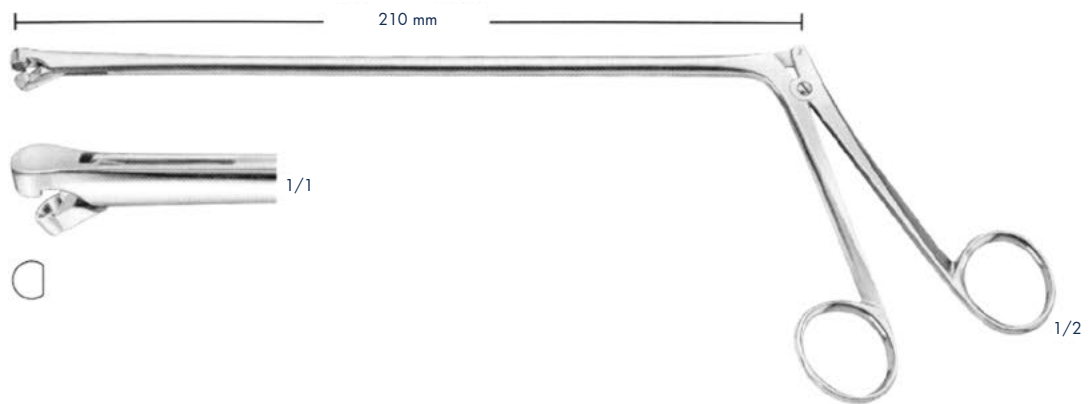

BERGER
OSI240419

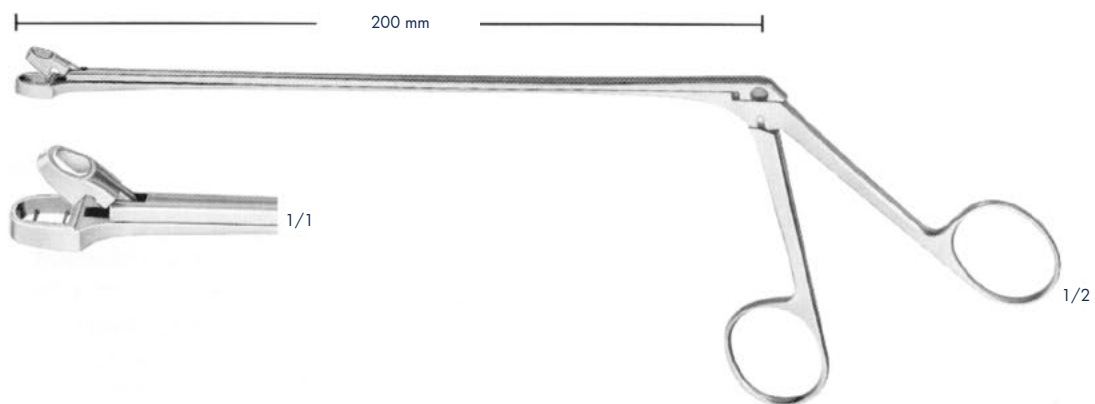

EPPENDORF
OSI240420
suitable for colposcopy

Biopsy Forceps

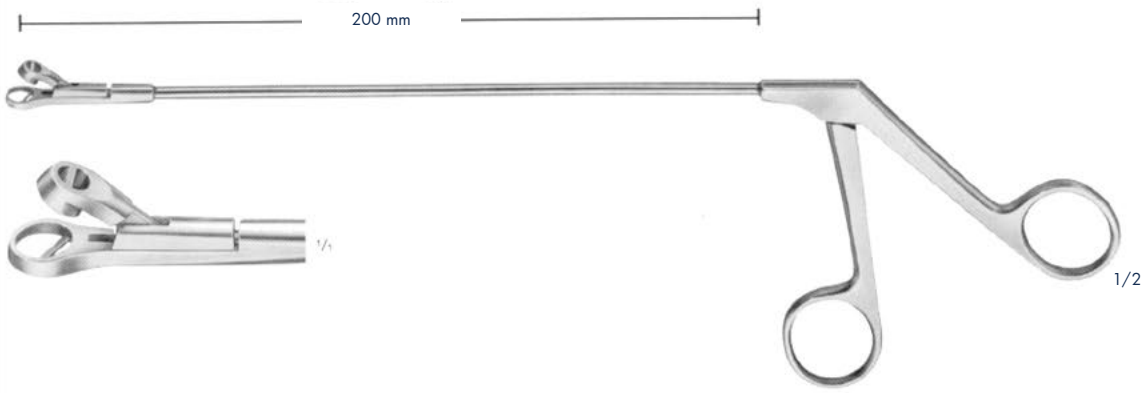

LEECH-WILKINSON
OSI240421

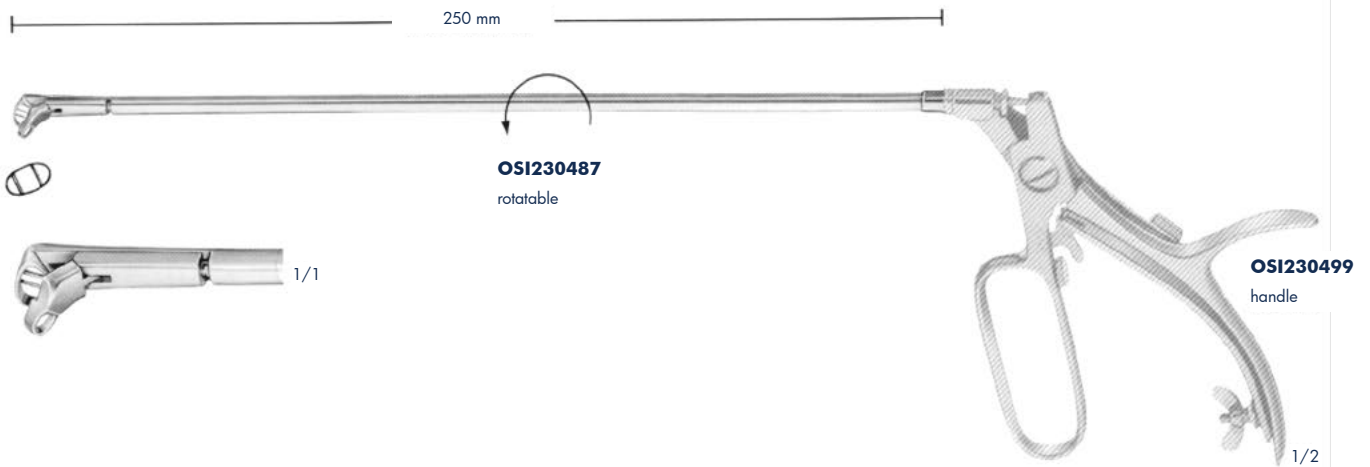

with drawing cut,
beginning from the top

OSI230487
attachment only

for handle

Biopsy Forceps

Universal handles



OSI230499
140 mm



HUBER
OSI260176
140 mm

Extension cannulae



BRUENINGS

- OSI260178** 200 mm
- OSI260632** 250 mm

Biopsie-Aufsätze
Biopsy tips



OSI260192



OSI260193



SCHEINMANN
OSI260186



SCHUMACHER
OSI260199
with drawing cut



KRAUSE
OSI260192 - OSI260193



Uterine Scoops



OSI240295
6,8 mm



OSI240296
8,5 mm



OSI240297
10 mm



OSI240298
11,5 mm

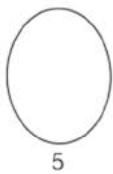

OSI240299
13 mm

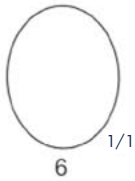

OSI240300
14,5 mm



1/2

SIMON

OSI240295 - OSI240300
max. 240 mm



OSI240301
6,8 mm



OSI240302
8,5 mm



OSI240303
10 mm



OSI240304
11,5 mm

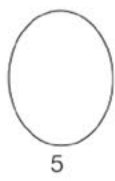

OSI240305
13 mm

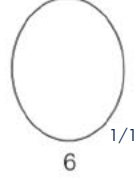

OSI240306
14,5 mm



1/2

SCHRÖDER

OSI240301 - OSI240306
max. 310 mm



OSI240422
6 mm



OSI240423
8 mm



OSI240424
10 mm



OSI240425
12 mm



OSI240426
14 mm



1/2

GOURDET

OSI240422 - OSI240426
blunt 280 mm

Uterine Curettes

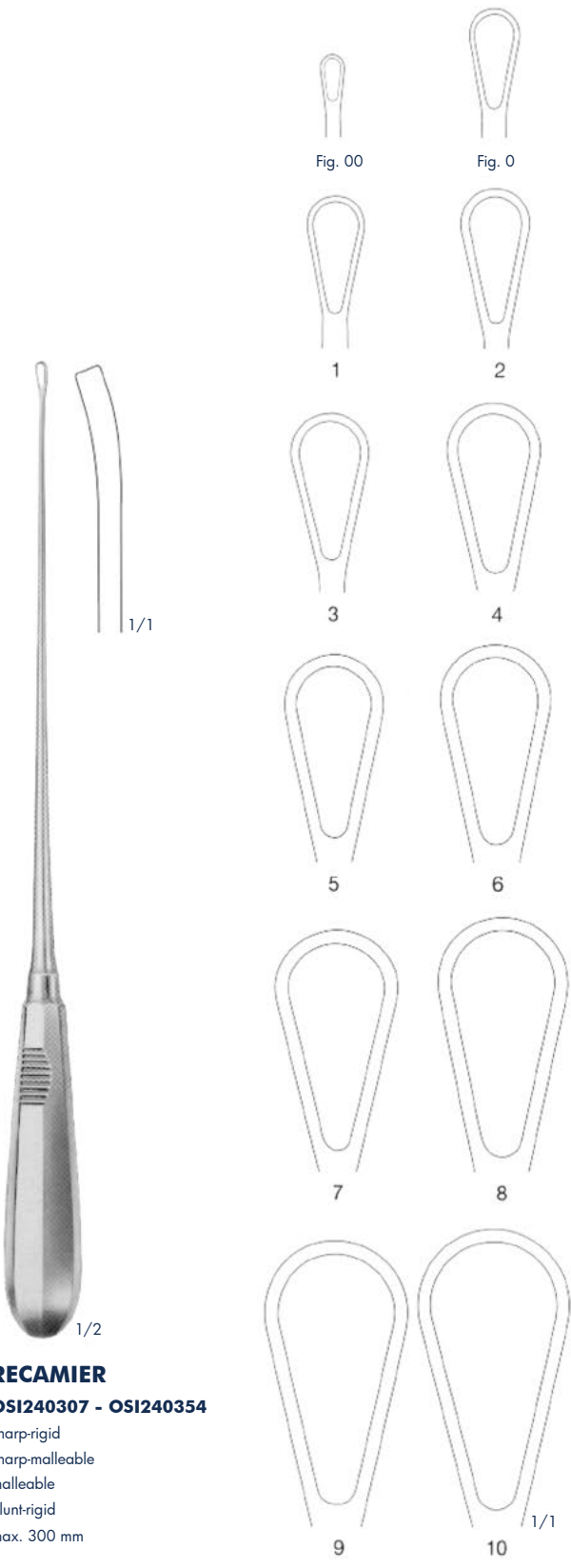

RECAMIER
OSI240307 - OSI240354
 sharp-rigid
 sharp-malleable
 malleable
 blunt-rigid
 max. 300 mm

Fig.	Width	sharp		blunt
		rigid	malleable	rigid
00	4,5 mm	OSI240307		
0	7,5 mm	OSI240308		OSI240344
1	8,5 mm	OSI240309	OSI240327	OSI240345
2	10,5 mm	OSI240310	OSI240328	OSI240346
3	12,0 mm	OSI240311	OSI240329	OSI240347
4	14,0 mm	OSI240312	OSI240330	OSI240348
5	15,0 mm	OSI240313	OSI240331	OSI240349
6	16,5 mm	OSI240314	OSI240332	OSI240350
7	18,0 mm	OSI240315	OSI240333	OSI240351
8	19,5 mm	OSI240316	OSI240334	OSI240352
9	21,5 mm	OSI240317		OSI240353
10	23,5 mm	OSI240318		OSI240354

Uterine Curettes



Fig. 1



Fig. 2



1/2



3



4



6



5



6 1/1

SIMS

OSI240427 - OSI240432
OSI240433 - OSI240438
OSI240439 - OSI240444

max. 225 mm

sharp-rigid
 sharp-malleable
 blunt-rigid

Fig.	Width	sharp		blunt
		rigid	malleable	rigid
1	7,5 mm	OSI240427	OSI240433	OSI240439
2	8,5 mm	OSI240428	OSI240434	OSI240440
3	10,5 mm	OSI240429	OSI240435	OSI240441
4	12,0 mm	OSI240430	OSI240436	OSI240442
5	14,0 mm	OSI240431	OSI240437	OSI240443
6	15,0 mm	OSI240432	OSI240438	OSI240444

Uterine Curettes

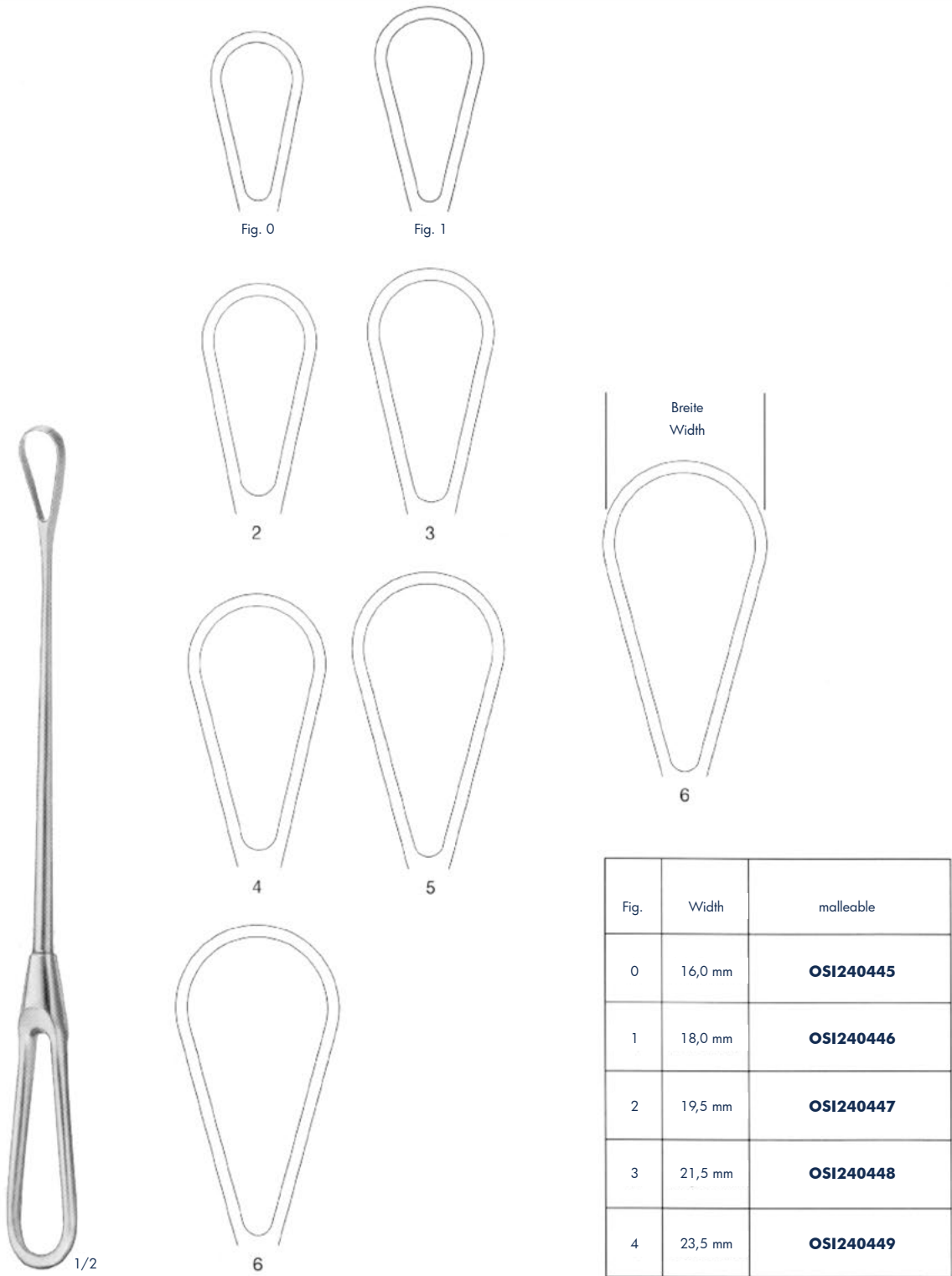

BUMM
OSI240445 - OSI240451
 blunt-malleable
 max. 290 mm

Fig.	Width	malleable
0	16,0 mm	OSI240445
1	18,0 mm	OSI240446
2	19,5 mm	OSI240447
3	21,5 mm	OSI240448
4	23,5 mm	OSI240449
5	26,0 mm	OSI240450
6	28,5 mm	OSI240451

Uterine Curettes, Placenta and Ovum Curettes

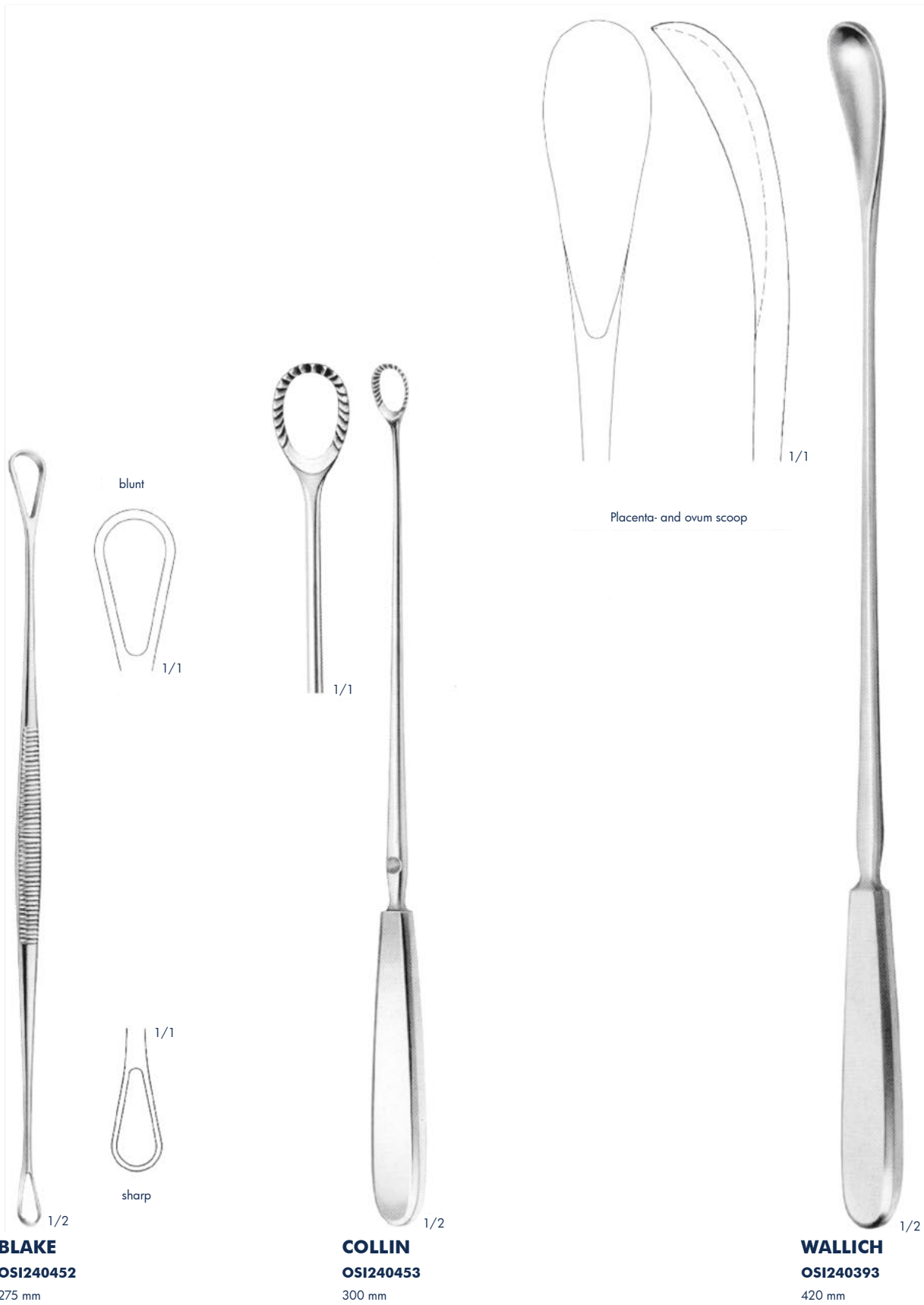

Placenta and Ovum Curettes

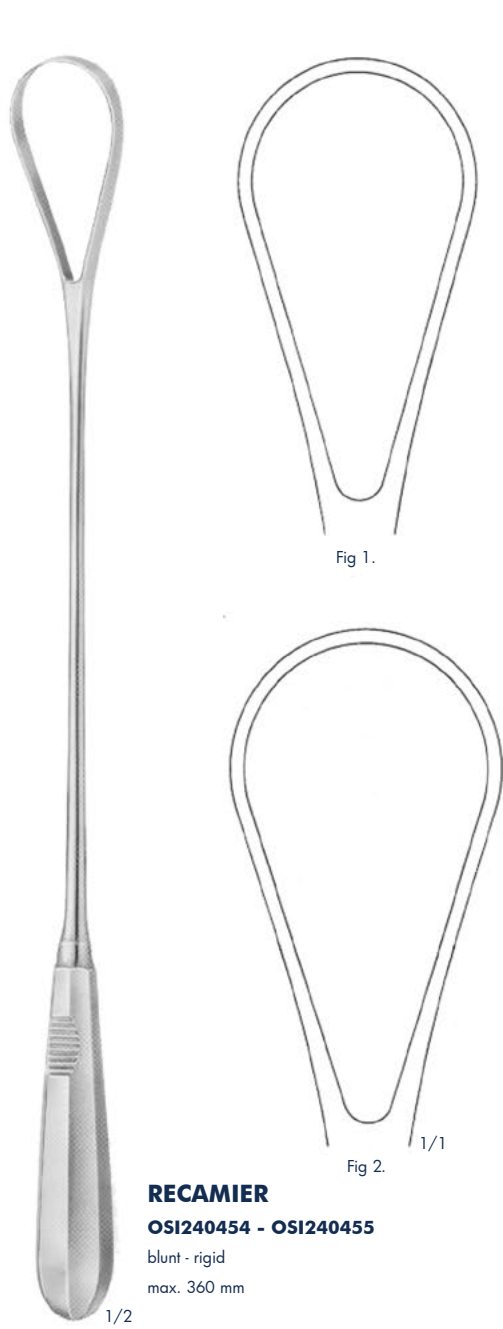

RECAMIER
OSI240454 - OSI240455
 blunt - rigid
 max. 360 mm

		blunt
Fig.	malleable	malleable
1	34,5 mm	OSI240454
2	39,5 mm	OSI240455

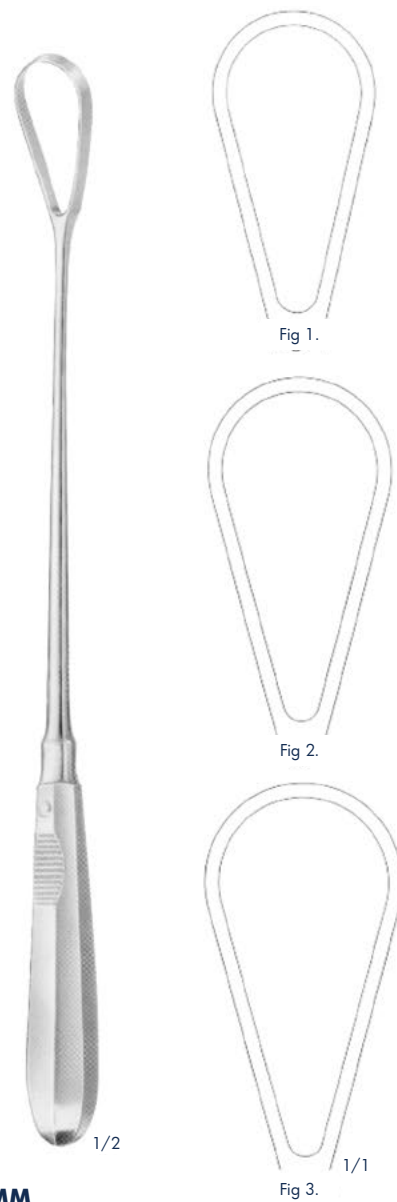

BUMM
OSI240456 - OSI240457
OSI240458 - OSI240460
 max. 310 mm

sharp-malleable
 blunt-malleable

		sharp	blunt
Fig.	Width	malleable	malleable
1	23,5 mm	OSI240456	OSI240458
2	26,0 mm		OSI240459
2	28,5 mm	OSI240457	OSI240460

Gynaecological Instruments

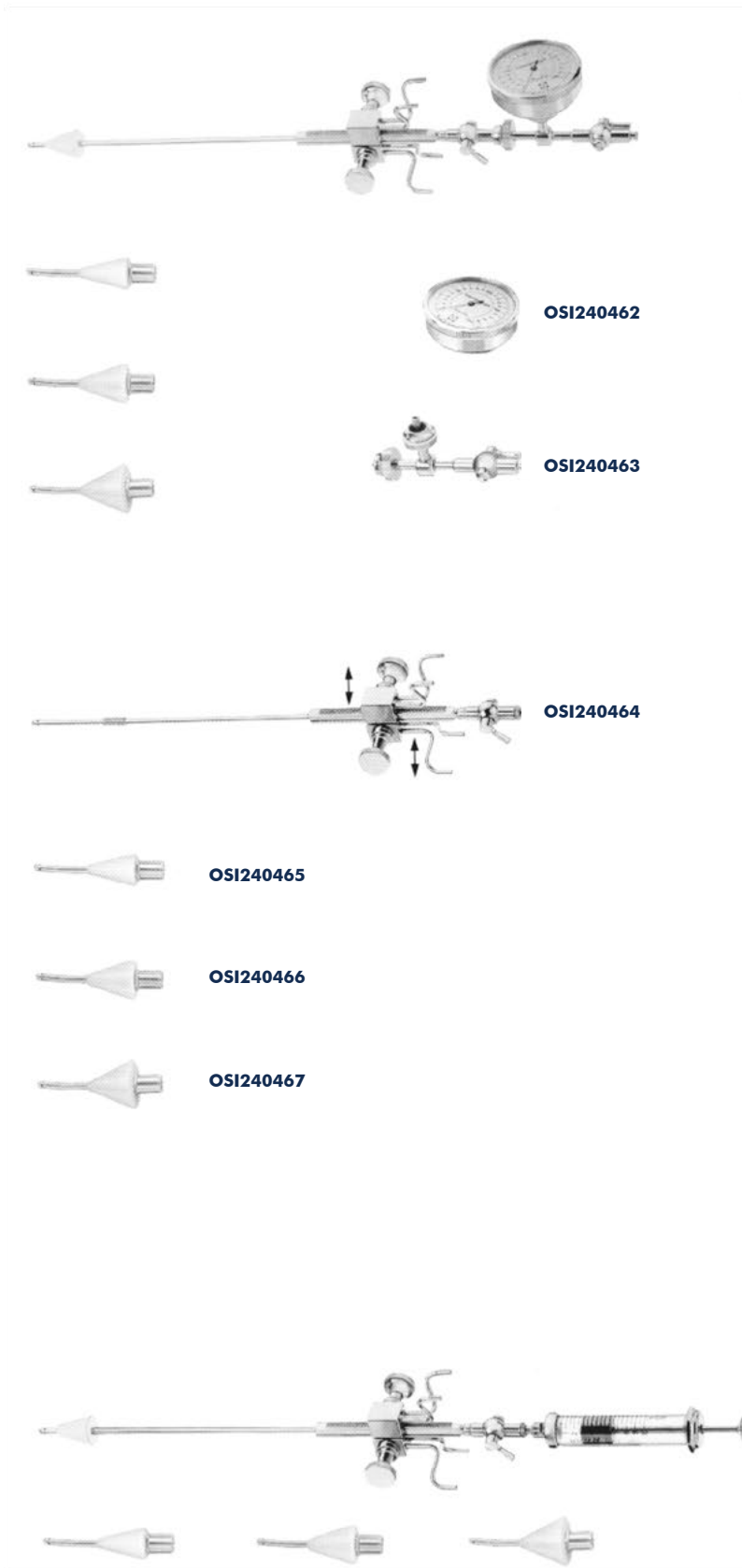

SCHULZE
OSI240461

Salpingograph, for utero-salpingography
in wooden case, consisting of:

- OSI240462** Manometer only
- OSI240463** Connection only, without manometer
- OSI240464** Uterine cannula with tap without cone
- OSI240465** Cone only, small
- OSI240466** Cone only, medium
- OSI240467** Cone only, large

SCHULZE
OSI240468

Salpingograph, equipment like **OSI240461**, but
without manometer

Uterine Cannulae



1/2
SPACKMAN

OSI240472
with adjustable plate for
vulsellum forceps
360 mm



OSI240469

small
Ø 10 x 25 mm

OSI240470

medium
Ø 13 x 30 mm

OSI240471

large
Ø 16 x 30 mm

LEECH-WILKINSON

OSI240469 - OSI240471

265 mm



1/2



- OSI240751** 40 mm
- OSI240752** 50 mm
- OSI240753** 60 mm

With traction handle
134°C Autoclavable



OSI240754

Hand valve with connection hose
20 cm long connection hose

Function:

The vacuum required can be constantly preset by the adjusting screw. This vacuum exists then up to the closed quick-shutter, thus the vacuum in the suction head is immediately put under the preset vacuum. In case the adjusting screw. For immediate removal of the suction head simply close the quickshutter, thus the vacuum in the suction head is eliminated at once whereas the vacuum in the section jar remains unchanged.

Uterine Cannulae, Irrigation Catheter



BEHRMAN
OSI240473
 with detachable cone
 305 mm



OSI240474
 with spring connector
 self-retaining, complete
 with 2 interchangeable
 cones large and small
 350 mm



ROTUNDA
OSI240475
 200 mm



BOZEMANN-FRITSCH
OSI240476 Ø 8 mm
OSI240477 Ø 10 mm
 Uterine flushing tube
 350 mm

Obstetrics - Pelvinimeters



THÖLE
OSI100216
for internal and external measurements,
graduated in centimeters
340 mm

1/2

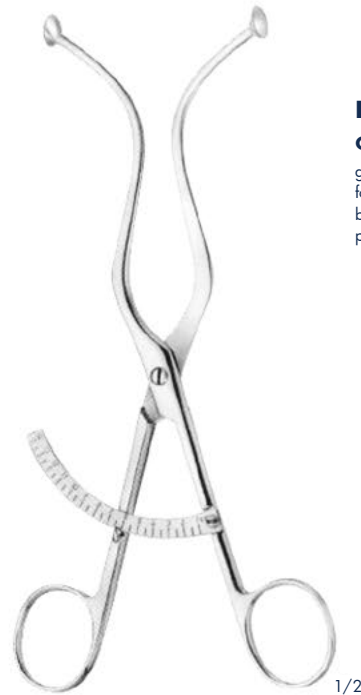

DE LEE
OSI240637
graduated in centimeters and inches
for interior measurements
between symphysis and
promontory

1/2



COLLIN
OSI240638
graduated in centimeters

1/2



MARTIN
OSI240639
graduated in centimeters

1/2



SCHNEIDER

OSI240640

graduated in centimeters

The additional straight arm can be replaced. The pelvimeter with straight arm is used for localisation of the portio vaginalis uteri and of vaginal metastases.



BREISKY

OSI240641

graduated in centimeters



OS1240644

Guide sheath
175 mm

OS1240645

Injection needle
luer-lock hub
1,0 x 185 mm

Special set for transvaginal injection for paracervical anaesthesia as well as anaesthesia of the pudendus

When the guide sheath is introduced at the spot to be injected the needle (mounted on the syringe) is then passed through the guide sheath and the tissue is finally injected.

Injuries of the vagina are thus avoided. Depth of puncture is limited to 10 mm

Thumb ring as well as a small support for middle- or forefinger facilitate the handling. Thumb ring slides on the guide sheath and can be fixed by a knurled nut to any size of the hand. The finger support can be turned round on the guide sheath so left-handers can use it, too. Completely away from the range of actions is the finger support when it is moved towards the thumb ring, e.g. for anaesthesia of the pudendus.



OS1240646

Injection needle
for pudendal block
140 mm

OS1240647

Injection needle
for pudendal block
140 mm



BEACHAM

OSI240248

Amniotome

240 mm



HERFF

OSI240648

Membrane
puncturing forceps

255 mm

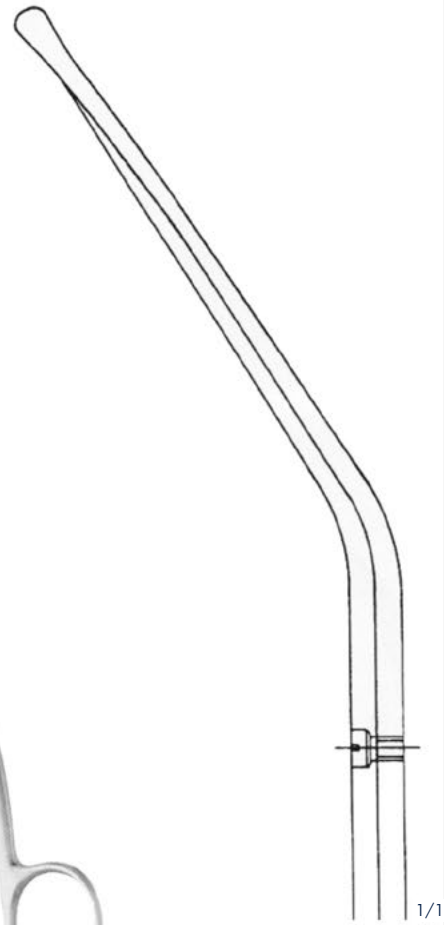

Scissors for Obstetrics



SCHUMACHER

OSI110315

Umbilical cord scissors
155 mm



OSI110314

Umbilical cord scissors
105 mm

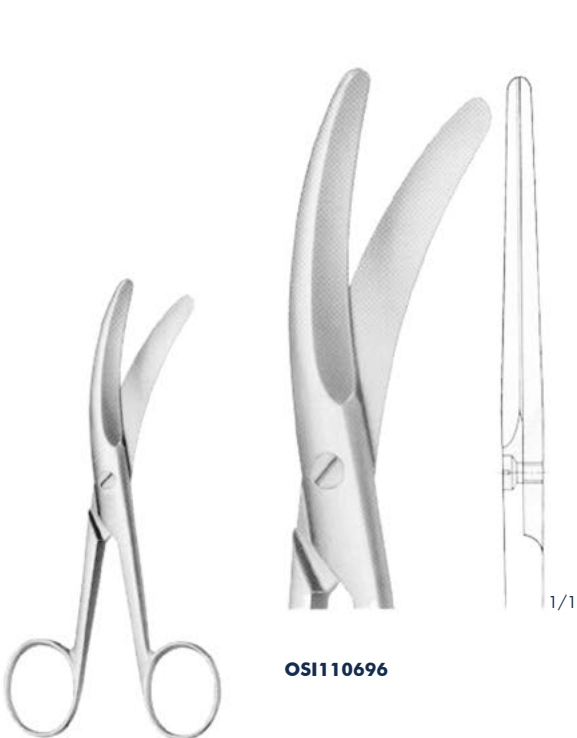

OSI110696

OSI110696 135 mm

OSI110316 160 mm

Umbilical cord scissors



OSI110316

Scissors for Obstetrics, Umbilical Dilator, Umbilical Cord Clamp



BRAUN-STADLER

OSI110321 145 mm

OSI110322 200 mm

Episiotomy scissors



1/1

OSI110321

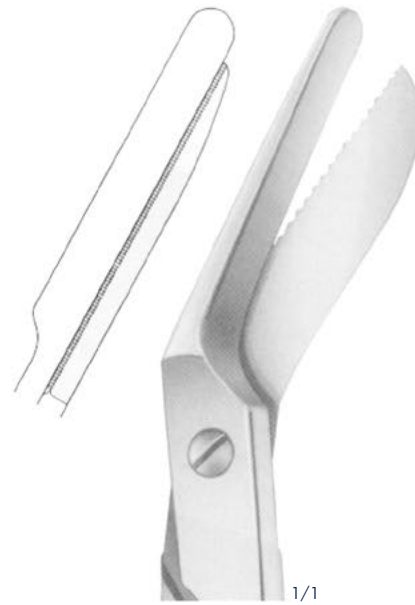

1/1

OSI110322

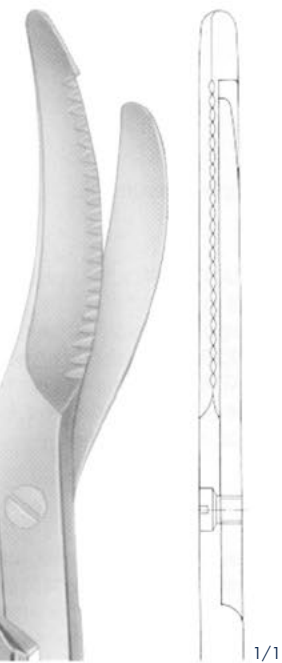

1/1

OSI110697

Episiotomy scissors
240 mm



1/1

OSI240649

Umbilical dilator
95 mm



1/1

COLLIN

OSI240650

Umbilical cord clamp
85 mm

Obstetrics - Obstetrical Forceps

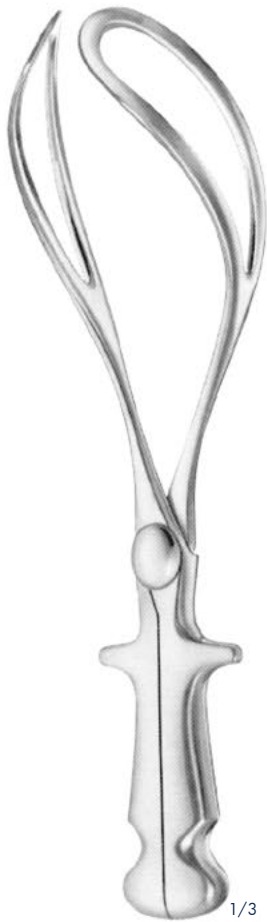

NAGELE
OSI240379
355 mm



NAGELE
OSI240380
400 mm



KIELLAND
OSI240390
420 mm

Obstetrics - Obstetrical Forceps

for delivery of the after coming head in breech presentation



SIMPSON-BRAUN
OS1240381
305 mm



SIMPSON-BRAUN
OS1240382
350 mm



PIPER
OS1240651
445 mm

Obstetrics - Obstetrical Forceps

for caesarean section



SIMPSON
OSI240652
235 mm

for caesarean section



WRIGLEY
OSI240653
250 mm

Obstetrics - Obstetrical Forceps

with traction rod



TARNIER
OSI240654
400 mm

with traction handle



BARNES-NEVILLE
OSI240655
435 mm

Obstetrics



SELLHEIM
OSI240394
Obstetric lever
300 mm

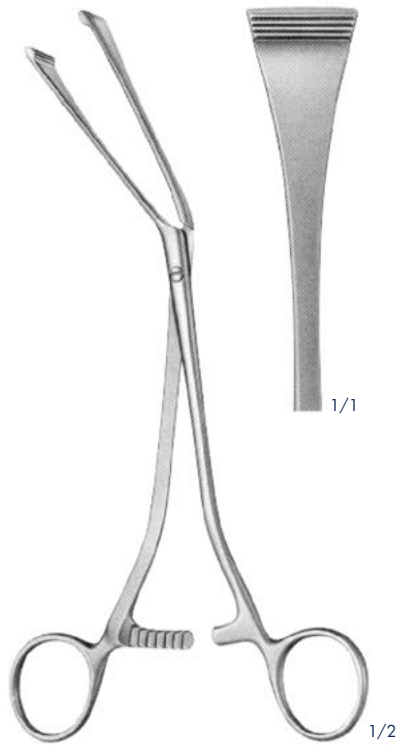

GREEN-ARMYTAGE
OSI240656
Haemostatic forceps, angled,
for edges of the transverse incision
in the lower segment
195 mm



GREEN-ARMYTAGE
OSI240657
Caesarean section haemostatic
forceps, for edges of the transverse
incision in the lower segment
220 mm

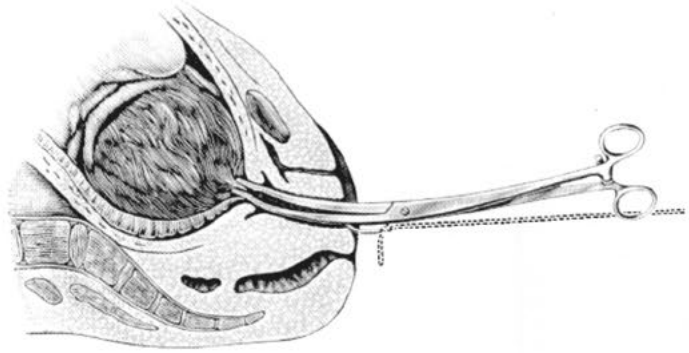

WILLETT
OSI210285
Scalp flap forceps
185 mm



GAUSS
OSI240658
Scalp flap forceps
260 mm

Obstetrics - Placenta and Ovum Forceps



Fig. 1
OSI240395

Fig. 2
OSI240397



Fig. 1
OSI240396

Fig. 2
OSI240659

Fig. 3
OSI240398



Fig. 2
OSI240660

Fig. 3
OSI240661



WINTER
OSI240395 (Fig. 1)
OSI240397 (Fig. 2)
290 mm



WINTER
OSI240396 (Fig. 1)
OSI240659 (Fig. 2)
OSI240398 (Fig. 3)
290 mm



mit sperre
with ratchet

WINTER
OSI240660 (Fig. 2)
OSI240661 (Fig. 3)
290 mm

Obstetrics - Placenta and Ovum Forceps



SAENGER
OS1240662
285 mm



SAENGER
OS1240663
275 mm

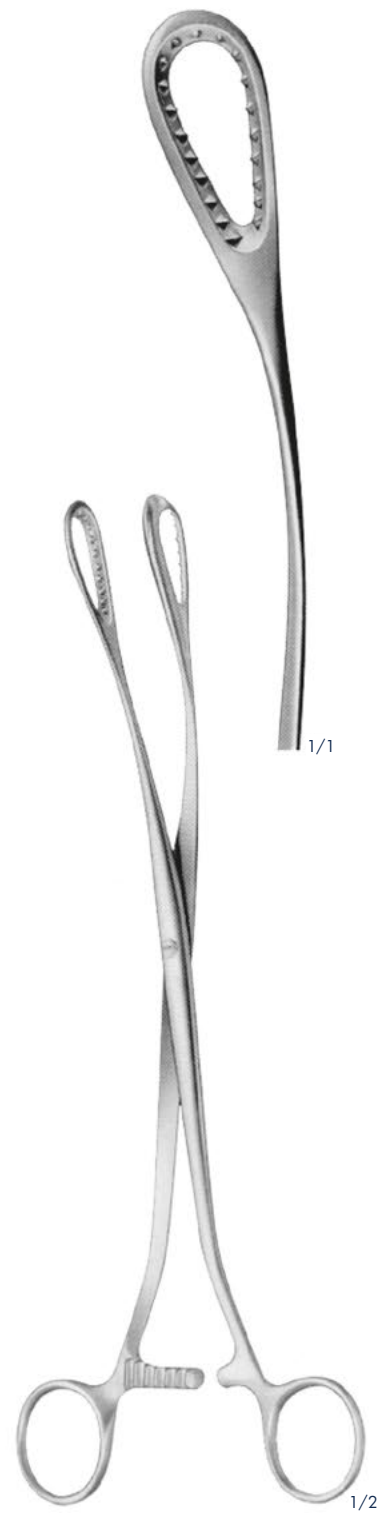

SAENGER
OS1240664
265 mm

Obstetrics - Placenta and Ovum Forceps

with protecting cap

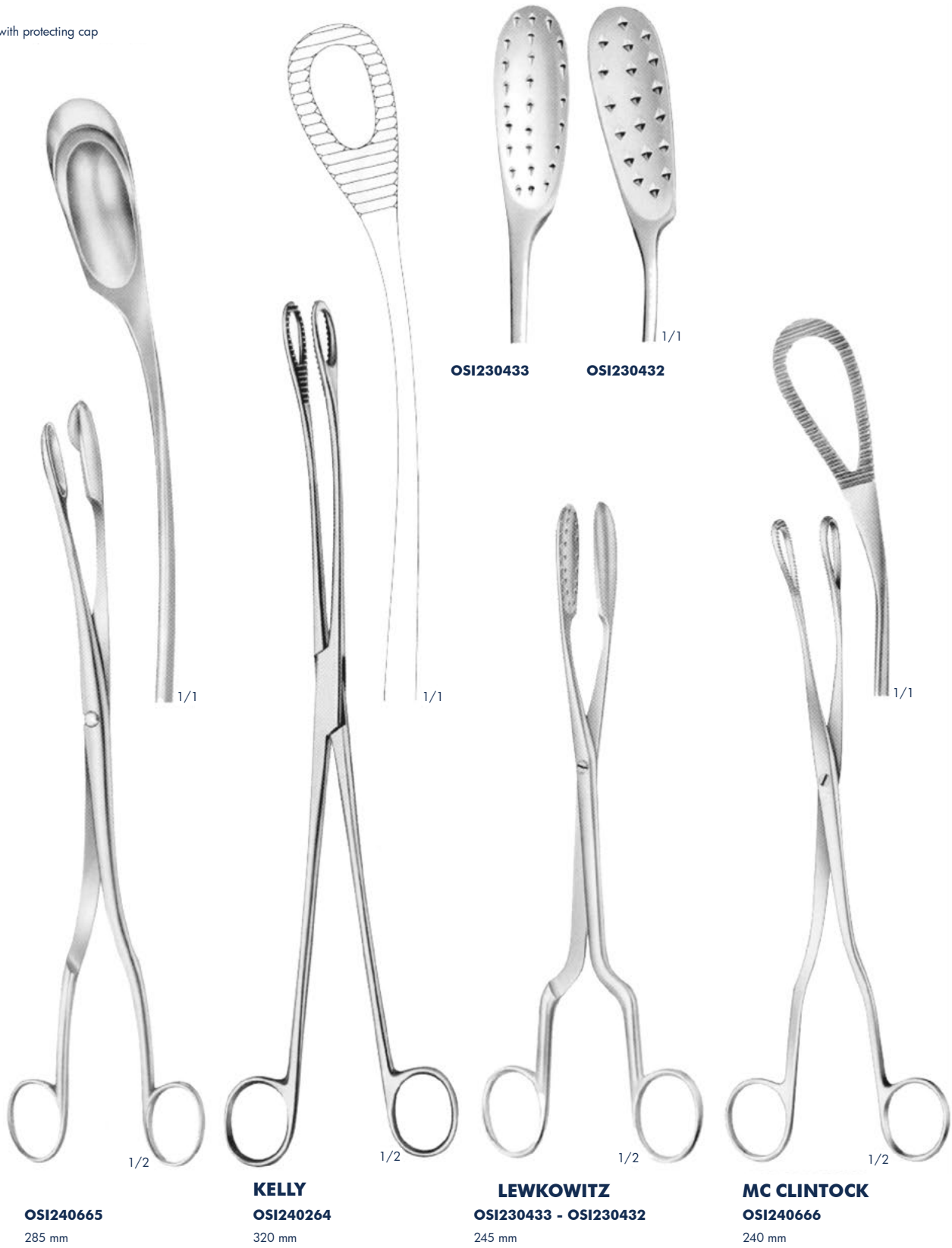

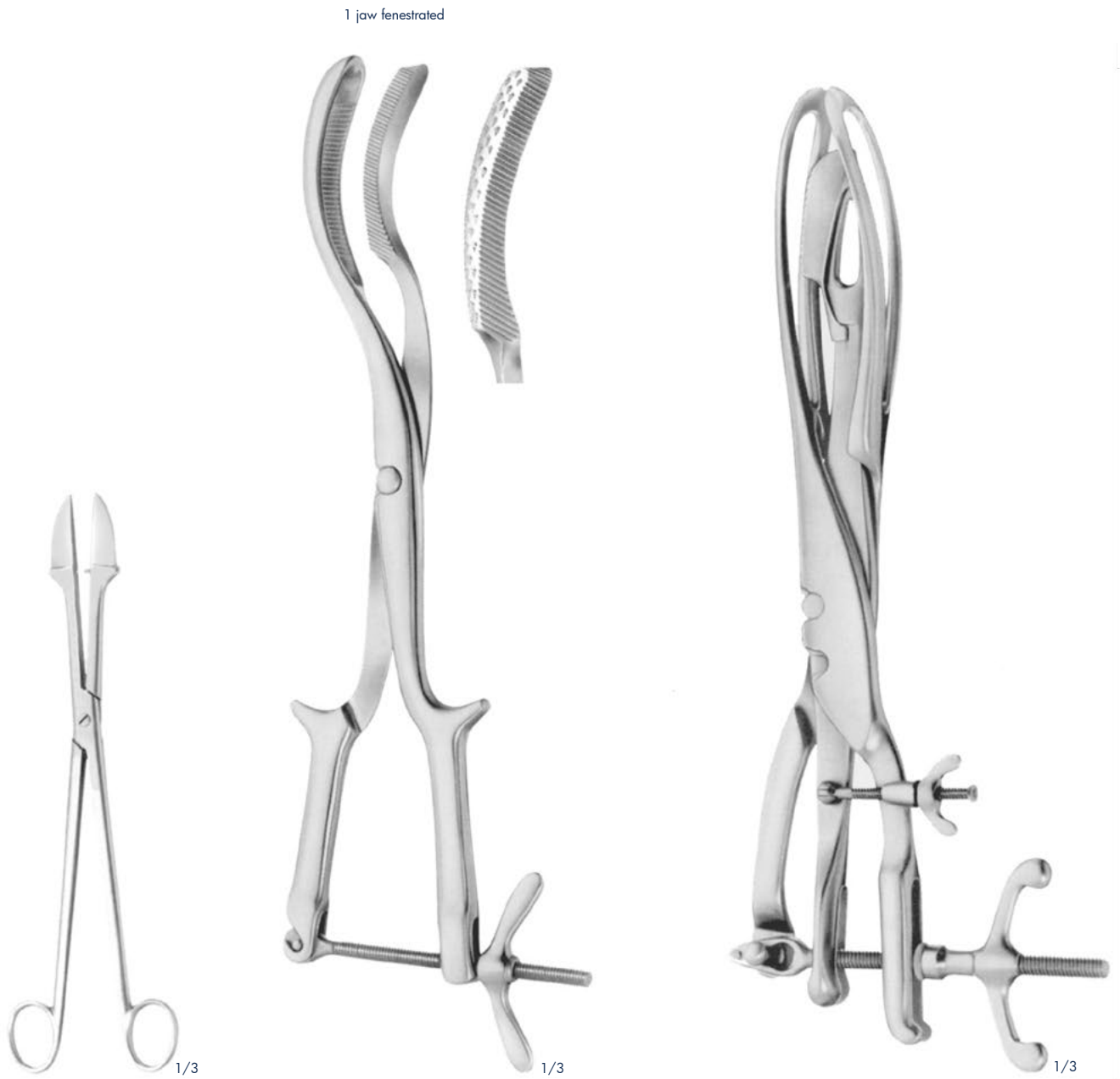

SMELLIE
OSI240667

Perforator
270 mm

BRAUN
OSI240668

Cranioclast
420 mm

TARNIER
OSI240669

BOSlotribe:
440 mm

Obstetrics



OSI110698



OSI110699

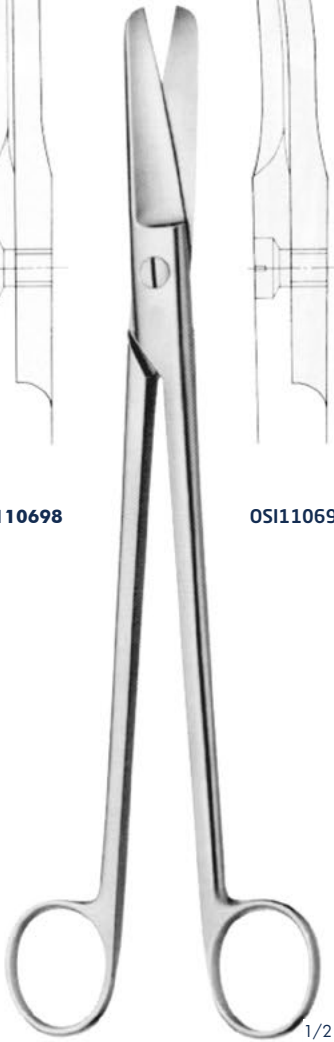

1/2

DUBOIS
OSI110698 - OSI110699
Decapitating
(Embryotomy) scissors
275 mm



1/1



1/2

BOER
OSI240670
Craniotomy forceps
290 mm



1/2

BRAUN
OSI240671
Decapitating Hook
325 mm

Tracheal Tubes with Inner Tubes

International scale for tracheal tubes, metal

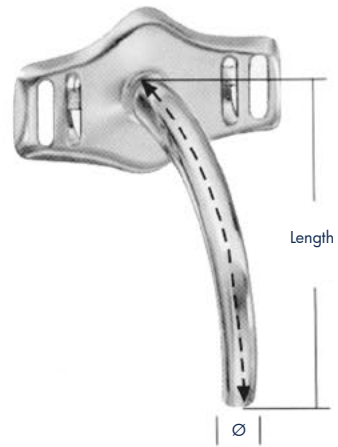

Fig.	0	1	2	3	4	5	6	7	8	9	10
Ø mm	4	5	6	7	8	9	10	11	12	13	14
Charr./Fr.	12	15	18	21	24	27	30	33	36	39	42



UECKERMANN-DENKER (MODIF. WEERA)

OSI220101

Cryothyrotomy trocar
with silver cannula
130 mm

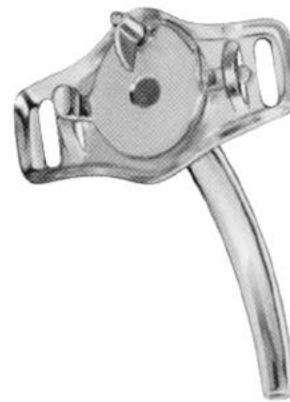

LUER

German silver

- OSI220166** Fig. 0 = 4 x 50 mm
- OSI220167** Fig. 1 = 5 x 50 mm
- OSI220168** Fig. 2 = 6 x 50 mm
- OSI220169** Fig. 3 = 7 x 55 mm
- OSI220170** Fig. 4 = 8 x 60 mm
- OSI220171** Fig. 5 = 9 x 65 mm
- OSI220172** Fig. 6 = 10 x 70 mm
- OSI220173** Fig. 7 = 11 x 80 mm
- OSI220174** Fig. 8 = 12 x 85 mm
- OSI220175** Fig. 9 = 13 x 90 mm
- OSI220176** Fig. 10 = 14 x 90 mm

Trocheal Tubes with Inner Tubes



stainless steel

JACKSON

diam. x length

- OSI220177** Fig. 1 = 5 x 48 mm
- OSI220178** Fig. 2 = 6 x 58 mm
- OSI220179** Fig. 3 = 7 x 70 mm
- OSI220180** Fig. 4 = 8 x 78 mm
- OSI220181** Fig. 5 = 9 x 84 mm
- OSI220182** Fig. 6 = 10 x 84 mm
- OSI220183** Fig. 7 = 11 x 86 mm
- OSI220184** Fig. 8 = 12 x 88 mm
- OSI220185** Fig. 9 = 13 x 90 mm
- OSI220186** Fig. 10 = 14 x 90 mm



German silver

Speaking tube

diam. x length

- OSI220187** Fig. 5 = 9 x 65 mm
- OSI220188** Fig. 6 = 10 x 70 mm
- OSI220189** Fig. 7 = 11 x 80 mm

Trocheal Tubes with Inner Tubes, Laryngectomy tubes

Valved inner tube

Sterling silver



NEGUS Charr./Fr.

OSI220200	16
OSI220201	18
OSI220202	20
OSI220203	22
OSI220204	24
OSI220205	26
OSI220206	28
OSI220207	30
OSI220208	32
OSI220209	34
OSI220210	36
OSI220211	38
OSI220212	40

with 2 inner tubes, 1 plain and 1 with speaking valve

Sterling silver



COLLEDGE

	Dimensions
OSI220213 extra small	12,0 mm
OSI220214 small	14,5 mm
OSI220215 medium	15,0 mm
OSI220219 large	15,5 mm

Laryngectomy tubes

with two outer cannulae and obturator

Wound and Tracheal Hooks

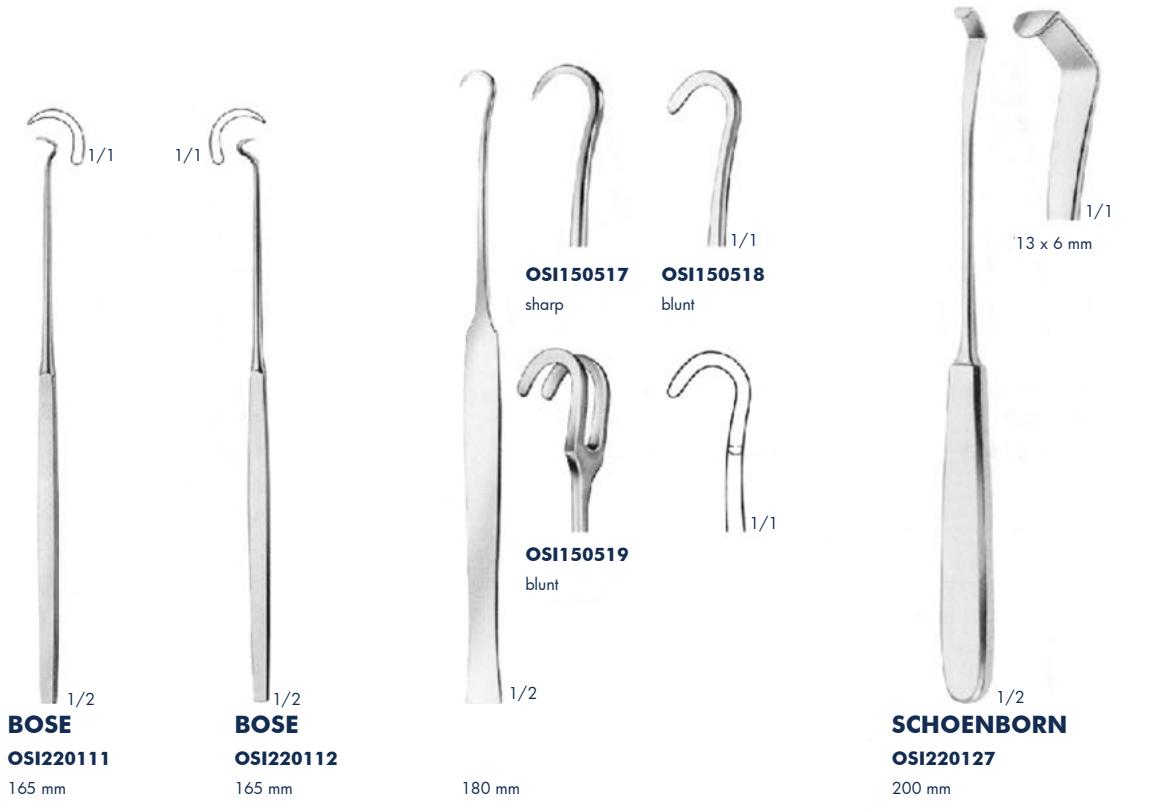

Tracheal Dilators



1/2

TROUSSEAU
OSI220104
120 mm



1/2

LABORDE
OSI220103
125 mm



1/2

LABORDE
OSI220216
strong pattern
135 mm



1/3

OSI220217
Cleaning brush
for tracheal tubes
285 mm

Vein Stripper Instruments



NABATOFF

OSI160145

Vein stripper set, consisting of:

- OSI160458** Metal case
- OSI160300** Flexible cable, 900mm
- OSI160298** Flexible plastic probe tip
- OSI160293** Metal probe tip
- OSI160294** Metal olive, Ø 6 mm
- OSI160295** idem, Ø 9 mm
- OSI160296** idem, Ø 12 mm
- OSI160297** idem, Ø 15 mm
- OSI160299** Handle for flexible cable

Spare parts for



OSI160298

Probe tip, flexible, plastic



OSI160293

Ø 3 mm
Probe tip, metal



OSI160294

Ø 6 mm
Olives only



OSI160295

Ø 9 mm



OSI160296

Ø 12 mm



OSI160297

Ø 15 mm

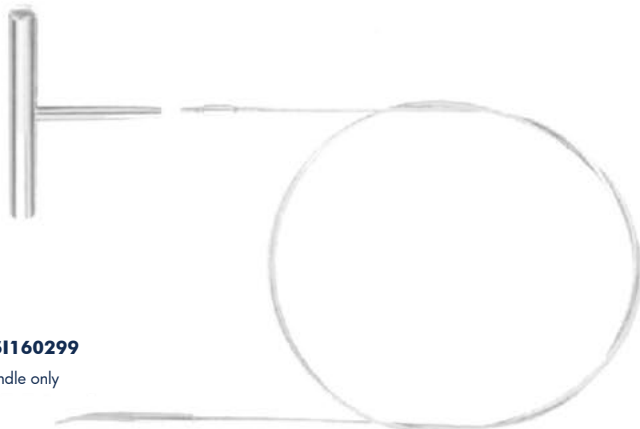

OSI160299

Handle only

OSI160300

Cable, flexible
1000 mm



VARADY
OSI200313

Mini vein stripper set consisting of:

OSI160458 Metal case

OSI200314 Flexible cable,
450mm long,
polyethylene coating

OSI200315 Metal olive, diam. 3 mm

OSI200316 idem, diam. 4 mm

OSI200317 idem, diam. 5 mm



OSI200315
Ø 3 mm



OSI200316
Ø 4 mm

Olives only



OSI200317
Ø 5 mm



OSI200314
Cable, flexible, polyethylene coating
450 mm

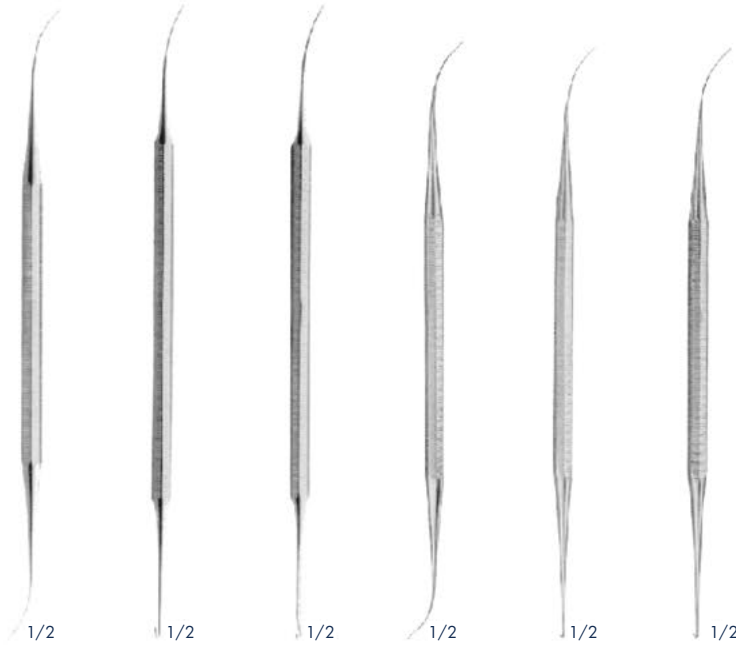

VARADY
OSI200318
Phlebodissector
180 mm

VARADY
OSI200319
Phlebextractor
180 mm

VARADY
OSI200320
Phlebextractor
180 mm

VARADY
OSI200321
Microspatula,
double ended
175 mm

VARADY
OSI200322
Micro
Phlebextractor
170 mm

VARADY
OSI200323
Mini
Phlebextractor
170 mm

Irrigating Cannulae, Embolus Grasping Forceps, Dilators

SCHMID
OSI200324 - OSI200327
 Vessel irrigating cannulae,
 malleable, silver plated
 150 mm

Ø 3 mm Ø 4 mm Ø 5 mm Ø 6 mm

BLAKE
OSI230264
 Embolus grasping
 forceps
 205 mm

DE BAKEY
OSI200272 Ø 0,5 mm
OSI200273 Ø 1,0 mm
OSI200274 Ø 1,5 mm
OSI200275 Ø 2,0 mm
OSI200276 Ø 2,5 mm
OSI200277 Ø 3,0 mm

DE BAKEY
OSI200278 Ø 3,5 mm
OSI200279 Ø 4,0 mm
OSI200280 Ø 4,5 mm
OSI200281 Ø 5,0 mm
OSI200282 Ø 7,0 mm
OSI200283 Ø 9,0 mm

Vascular dilators, malleable
 190 mm

LOCK

1/1

1/1

1/2

1/1

1/1

1/1

1/1

1/2

Vascular Spatulas

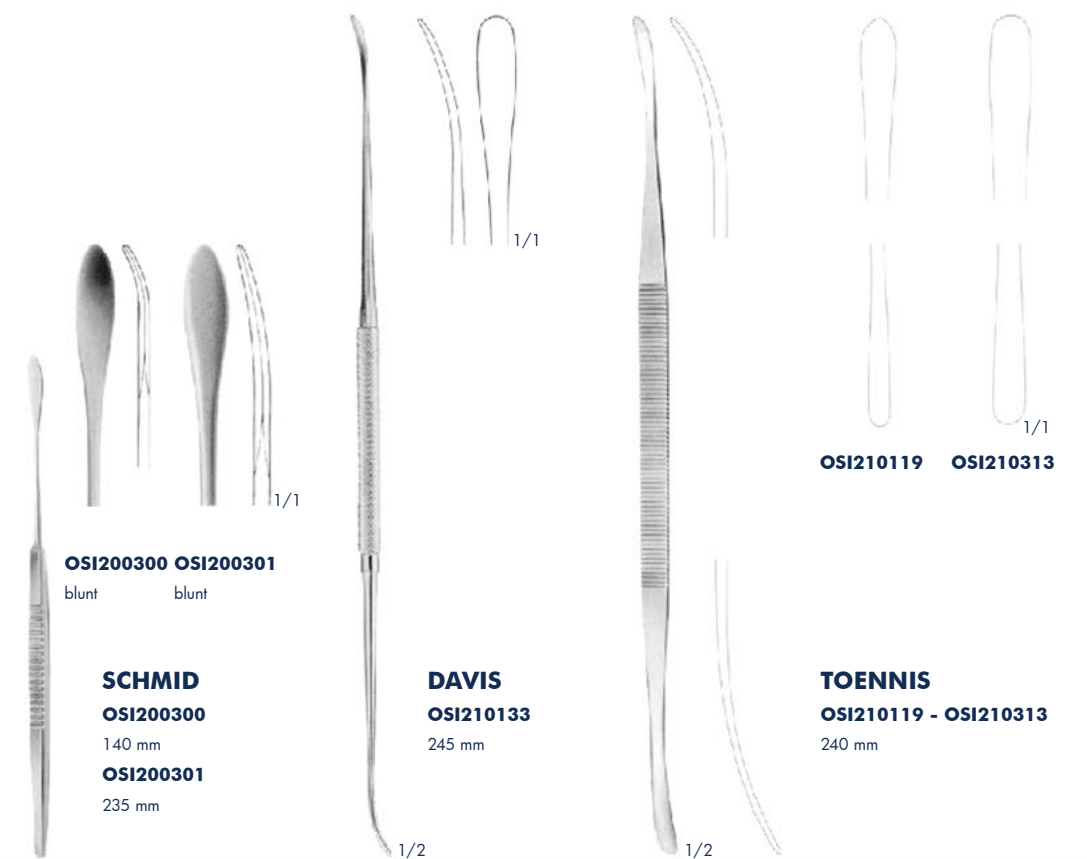
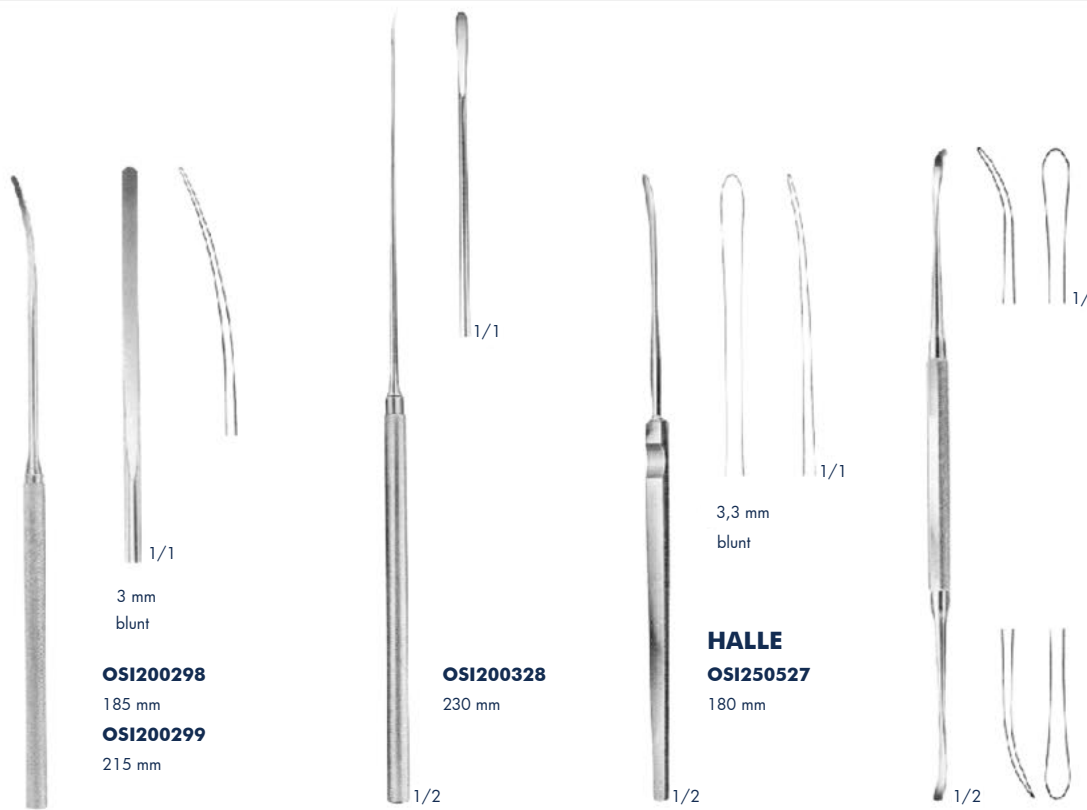

Endarterectomy Strippers, Tourniquets

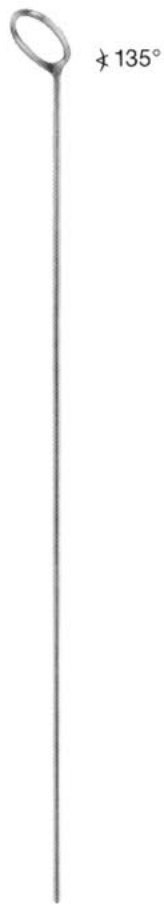
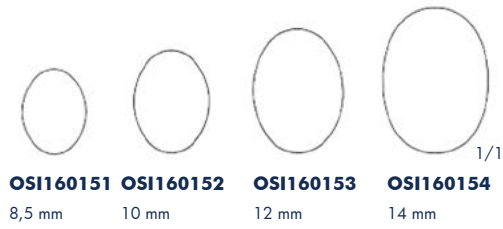
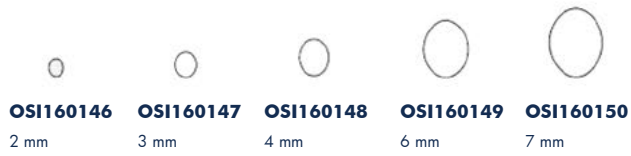

OSI160146 - OSI160154
 Endarterectomy strippers
 550 mm



OSI160155
 Handle for
 110 mm



RUMEL-BELMONT
OSI200329 Ø 4,0 mm
 325 mm



OSI200330

OSI200330
 Guide only

Bioptome and Aortic Dilators, Aorta Punches

SCHULZ

OSI200331

Bioptome, with flexible shaft,
510 mm long,
with round jaws 3 mm diam.

Biopsy forceps, for biopsy from the right atrium
through cava jugularis, prior to heart implantations.

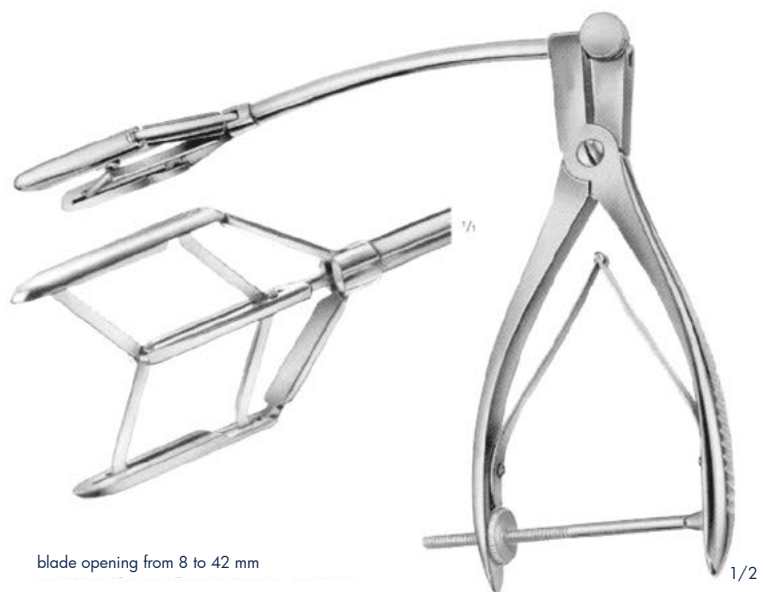
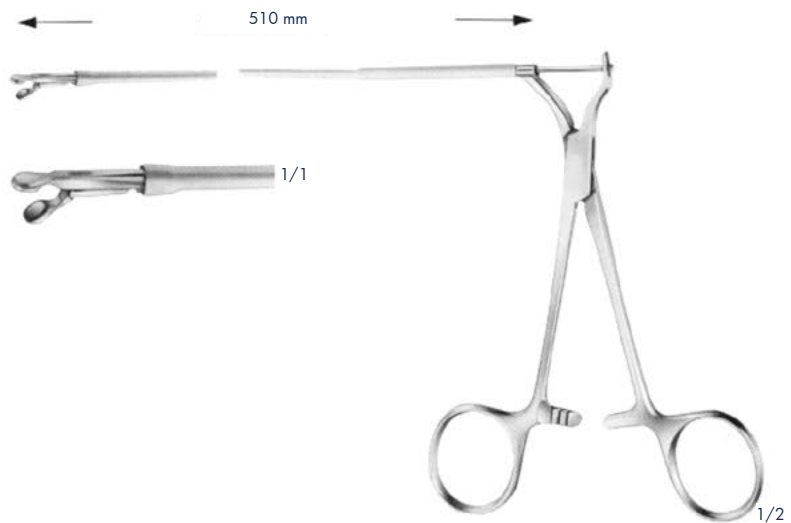

TUBBS

OSI200262

Dilator for mitral valve

OSI200332 - OSI200334

140 mm

OSI200332

4 mm

OSI200333

5 mm

OSI200334

6 mm

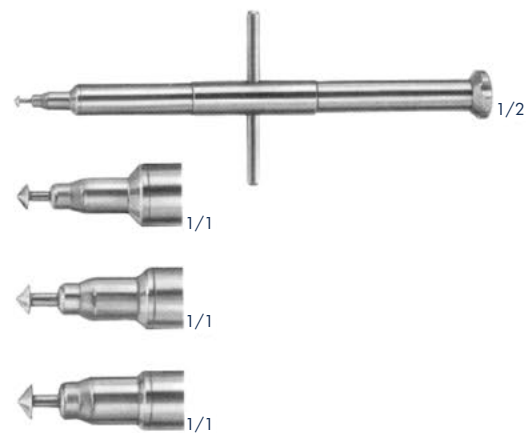

Aorta punches

Instrument Set for Tunneling and Pulling-through Vascular Grafts

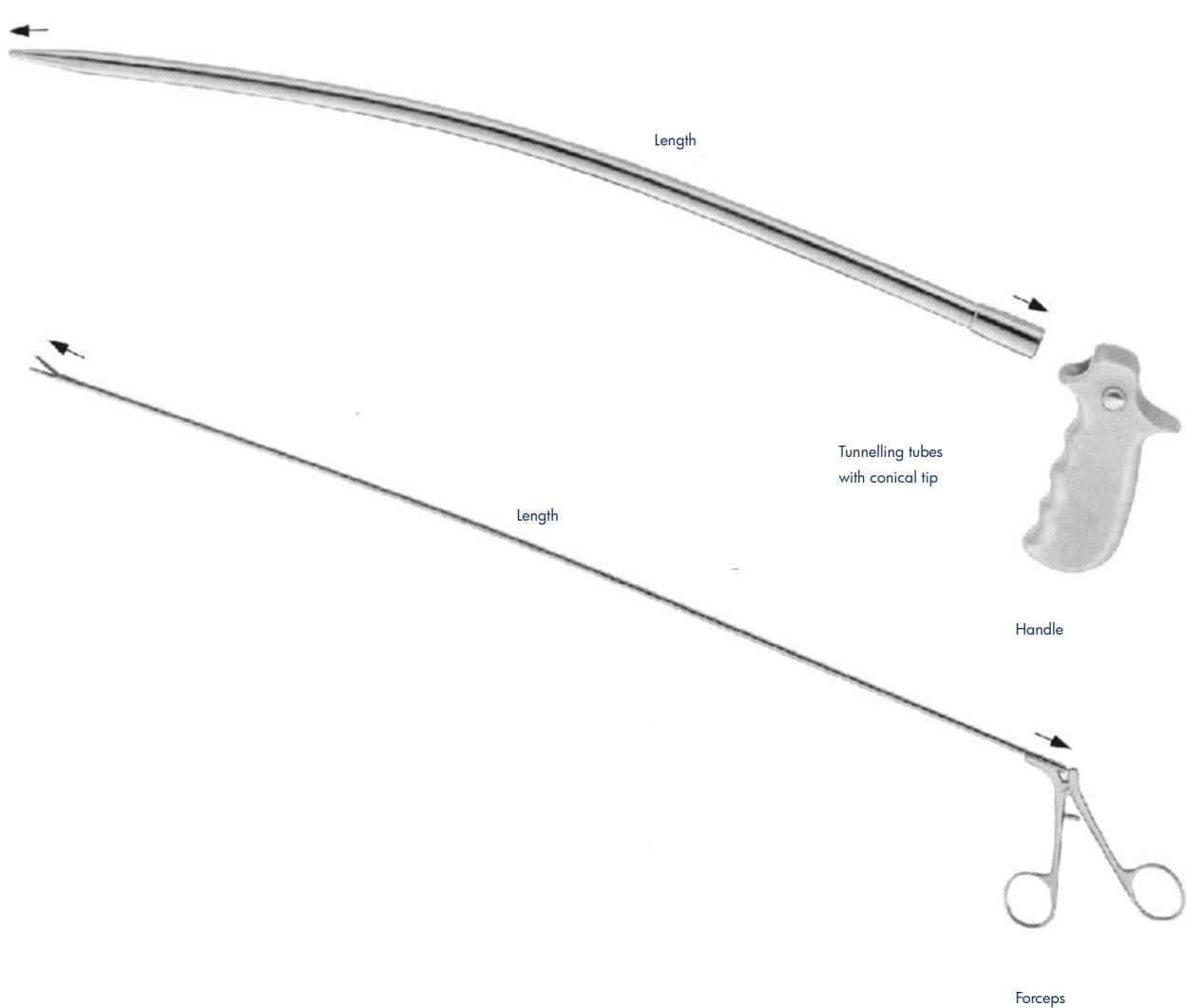

Tunnelling tubes with conical tip Length Ø/diam. 12 mm Ø/diam. 14 mm Ø/diam. 17 mm	400 mm	500 mm
	OSI200336	OSI200337
	OSI200338	OSI200339
	OSI200340	OSI200341
Handle	OSI200335	
Forceps	OSI200342	OSI200343

Vascular Prosthesis Draw-in Forceps



ALLENBERG

OSI200344

curved
540 mm

OSI200345

Bulldog clamp
40 mm

The slight curvature of the introducer forceps permits optimal handling during tunneling. Here the prosthesis can be drawn in by applying the introducer forceps directly to the prosthesis (alloplastic prosthesis) or can be drawn in by means of the bulldog clamp (autologous/homologous prosthesis). Thanks to the interlocking fit, the bulldog clamp rests non-displaceable and securely in the mouth of the introducer forceps.

Instruments Acc. To HELLBERG/KUPKA, ergonomic handle

These instruments provide the surgeon with a maximum of ergonomical comfort.

The optimized design of the Instruments offers a fatigue-free working especially with regard to difficult suture and anastomosis techniques.

For further details see our leaflet



HELLBERG/KUPKA

OSI170369

Needle holder

210 mm

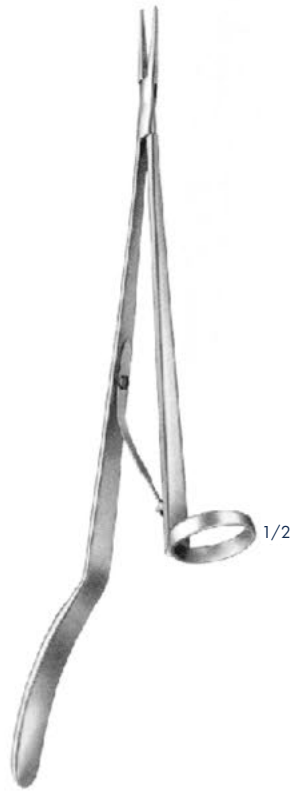

HELLBERG/KUPKA

OSI200346

Atraumatic clamp

Jaw width: 1.5 mm

230 mm



HELLBERG/KUPKA

OSI110668

Micro scissors

sharp/sharp, curved

210 mm

Instruments Acc. To REIN/KUPKA, ergonomic handle

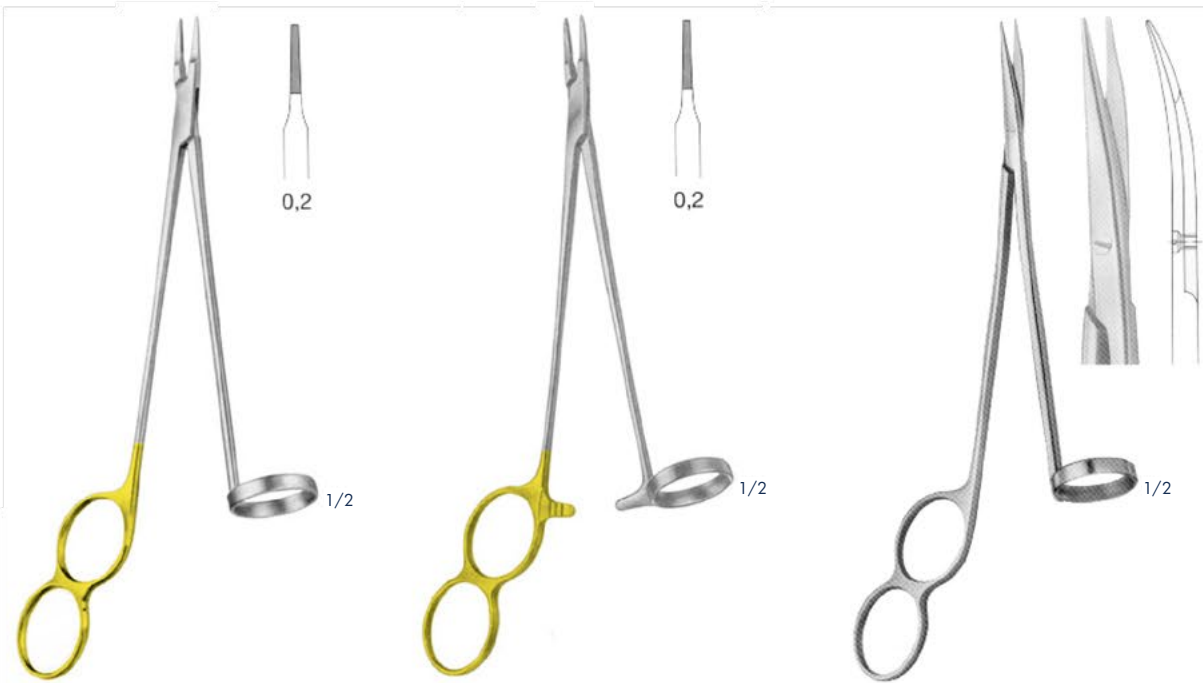

REIN/KUPKA

OSI170370

Needle holder
190 mm

REIN/KUPKA

OSI170371

Needle holder with catch
190 mm

REIN/KUPKA

OSI110669

Dissecting scissors, curved
195 mm



REIN/KUPKA

OSI200347

Sponge forceps
1 x 2 teeth
195 mm



REIN/KUPKA

OSI200348

Atraumatic clamp
Jaw width: 1.5 mm
195 mm

Toothings

ATRAUMATIC



DE BAKEY

1 : 2 rows of teeth

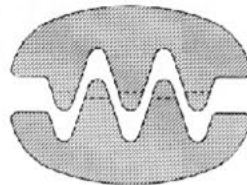

DE BAKEY

2 : 3 rows of teeth

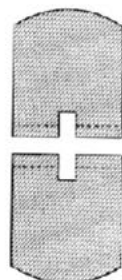
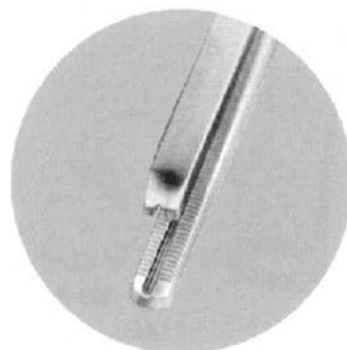

COOLEY

2 : 2 rows of teeth

Ultra-Light-Forceps

ATRAUMATIC



OSI120420

Width of jaws : 1,2 mm

Length : 150 mm

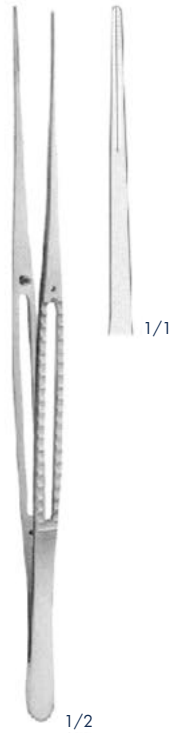

OSI120360

1,5 mm

200 mm



OSI120361

1,5 mm

240 mm



OSI120362

1,5 mm

300 mm

Forceps

ATRAUMATIC



DE BAKEY

OSI200349 195 mm
OSI200350 240 mm



DE BAKEY

OSI200127 - OSI200128

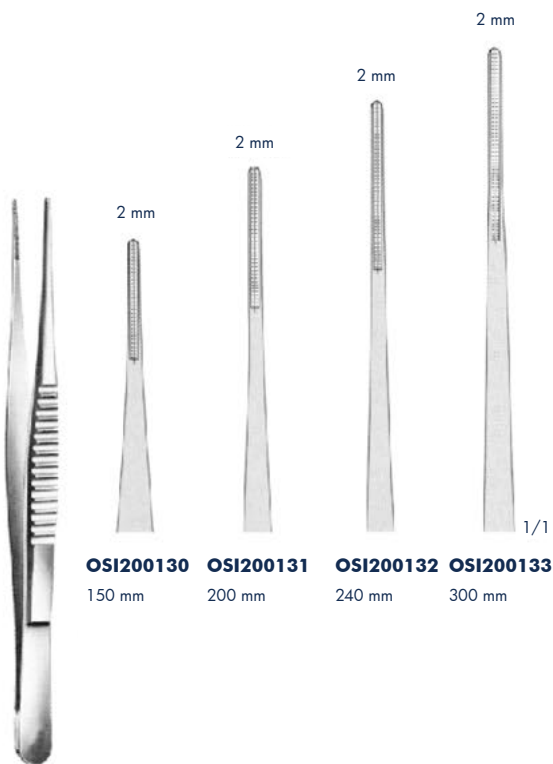
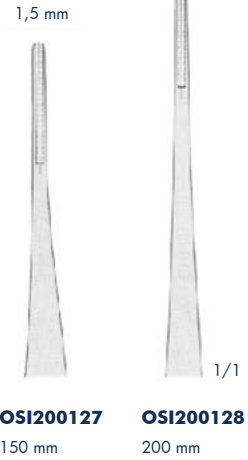

DE BAKEY

OSI200130 - OSI200133

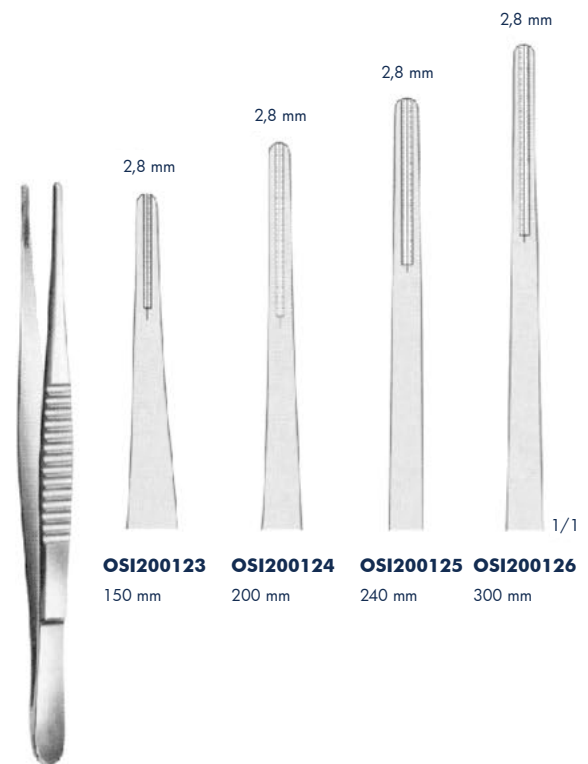

DE BAKEY

OSI200123 - OSI200126

Forceps

ATRAUMATIC

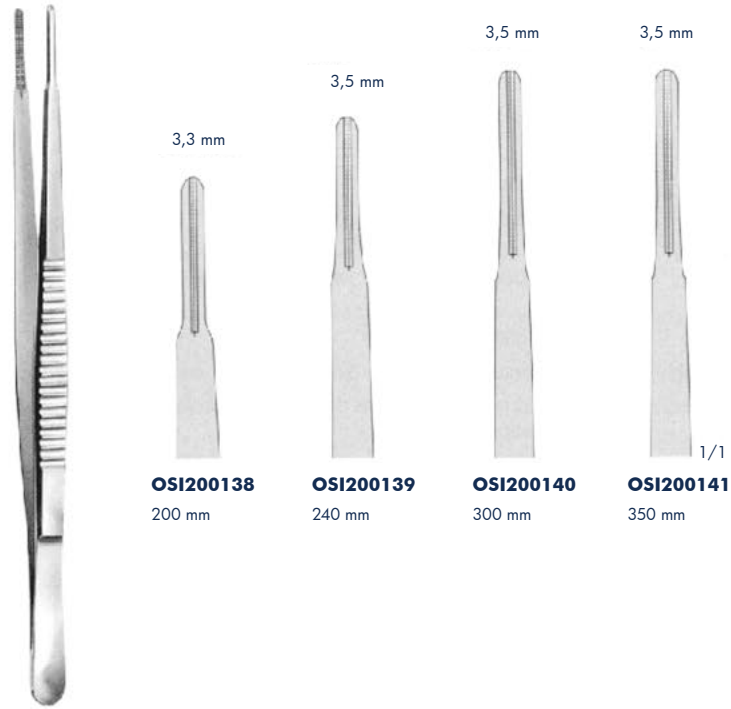

DE BAKEY
OSI200138 - OSI200141

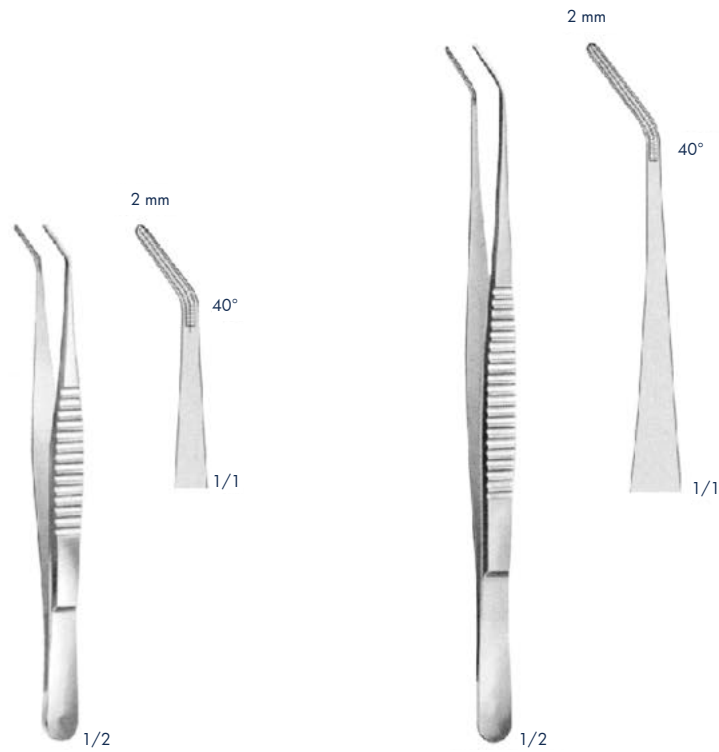

DE BAKEY
OSI200134
150 mm

DE BAKEY
OSI200135
200 mm

MÜLLER Vascular Clips

MÜLLER Vascular Clips

Features:

- Atraumatic mouth profile.
- Handle plateaux mounted on both sides for secure application and removal of the clip.
- Exactly defined closing pressure for arterial and venous vessels.
- Vascular clips are clearly marked with closing pressure.
- Closed mouth box guarantees precise guidance of the working tips.
- No risk of threads getting tangled up in clip

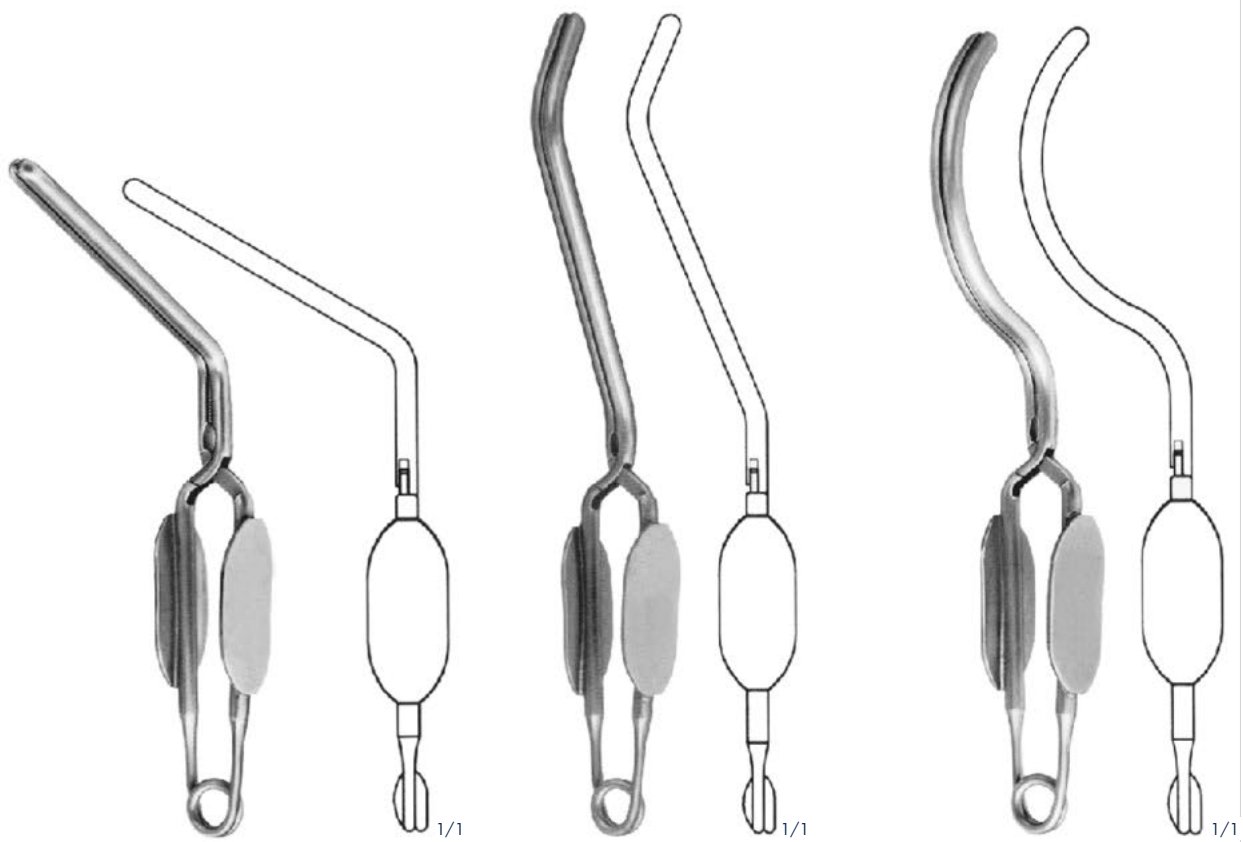

Closing force

MÜLLER

OS1130401 250 g

OS1130402 350 g

straight

Closing force

MÜLLER

OS1130403 250 g

OS1130404 350 g

curved

Closing force

MÜLLER

OS1130405 250 g

OS1130406 350 g

curved tips

MÜLLER Vascular Clips

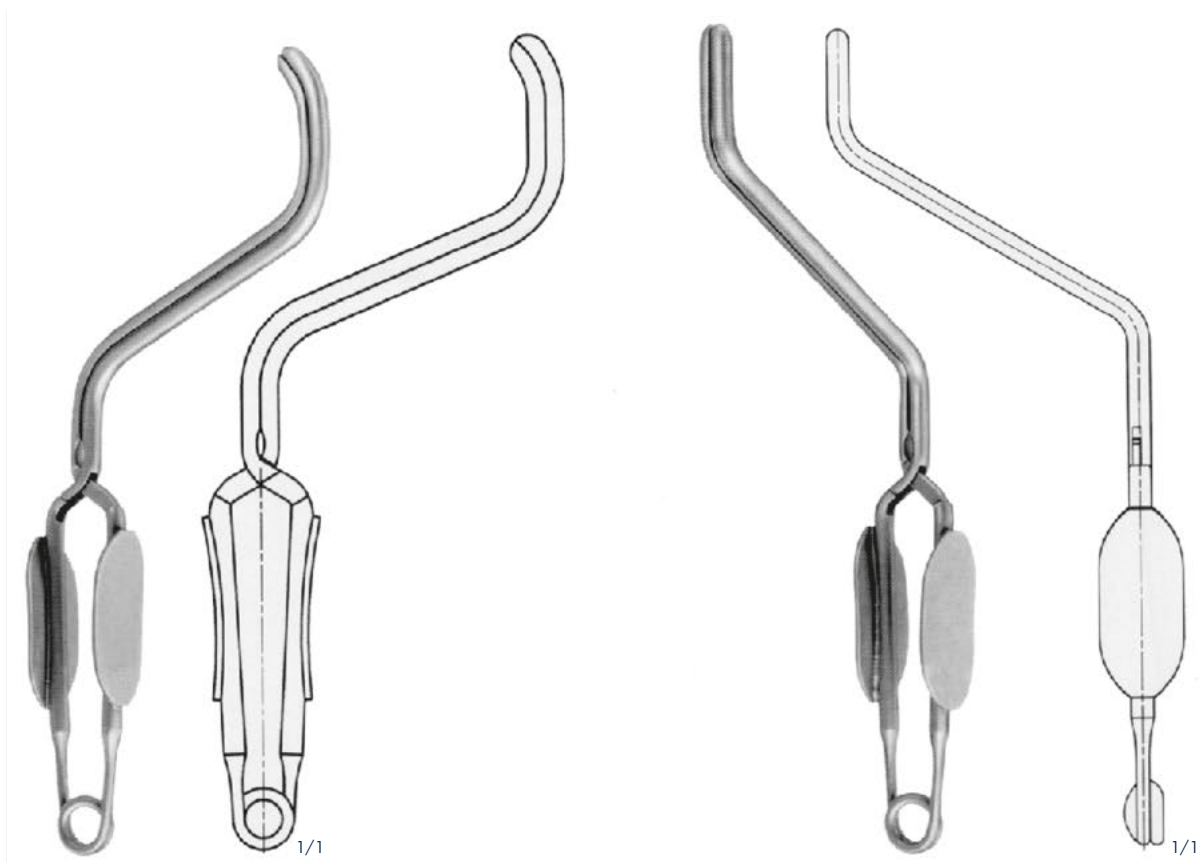

Closing force

MÜLLER
OSI130407 250 g
OSI130408 350 g
angled-shaped

Closing force

MÜLLER
OSI130409 250 g
OSI130410 350 g
knee-bent

Bulldog Clamps



1/1
OSI130411
35 mm



1/1
OSI130412
35 mm



1/1
OSI130413
45 mm



1/1
OSI130414
45 mm



DIEFFENBACH
OSI130415 38 mm
OSI130417 48 mm



DIEFFENBACH
OSI130416 38 mm
OSI130418 48 mm



DIEFFENBACH
OSI130419 58 mm



DIEFFENBACH
OSI130420 58 mm

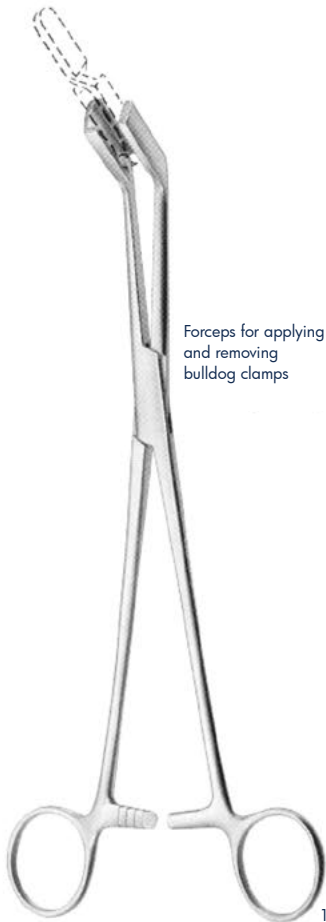

Forceps for applying and removing bulldog clamps

JOHNS-HOPKINGS
OSI130569
240 mm



JOHNS-HOPKINGS
OSI130421 38 mm
OSI130109 48 mm
OSI130422 56 mm
OSI130110 63 mm
OSI130423 70 mm
OSI130111 80 mm
OSI130424 91 mm









DE BAKEY-HESS
OSI130425
Length of jaw:
20 mm



DE BAKEY-HESS
OSI130426
Length of jaw:
30 mm

Bulldog Clamps

ATRAUMATIC

						
	1/2	1/2	1/2	1/2	1/2	1/2
	DE BAKEY	DE BAKEY	GLOVER	DE BAKEY	DE BAKEY	DE BAKEY
	OSI130427	OSI130428	OSI130429	OSI200108	OSI200110	OSI200109
Total length	50 mm	48 mm	57 mm	73 mm	99 mm	95 mm
Length of jaws	27 mm	27 mm	35 mm	38 mm	63 mm	54 mm



DE BAKEY

	Total length	Length of jaw
OSI130430	80 mm	25 mm
OSI130432	90 mm	35 mm
OSI130434	105 mm	50 mm
OSI130436	124 mm	68 mm



DE BAKEY

	Total length	Length of jaw
OSI130431	78 mm	25 mm
OSI130433	86 mm	35 mm
OSI130435	97 mm	50 mm
OSI130437	114 mm	68 mm



GLOVER

	Total length	Length of jaw
OSI130438	68 mm	33 mm
OSI130440	96 mm	50 mm
OSI130442	117 mm	69 mm



GLOVER

	Total length	Length of jaw
OSI130439	65 mm	33 mm
OSI130441	91 mm	50 mm
OSI130443	110 mm	69 mm

Ring Handle Bulldog Clamps

ATRAUMATIC

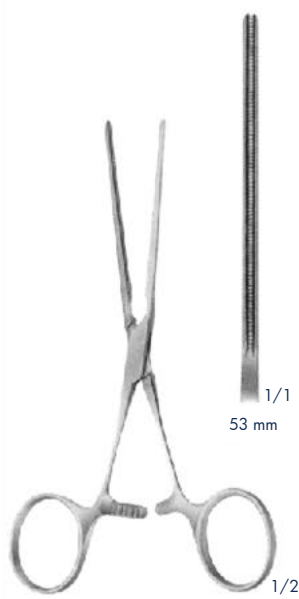

DE BAKAY
OSI200241
straight
130 mm

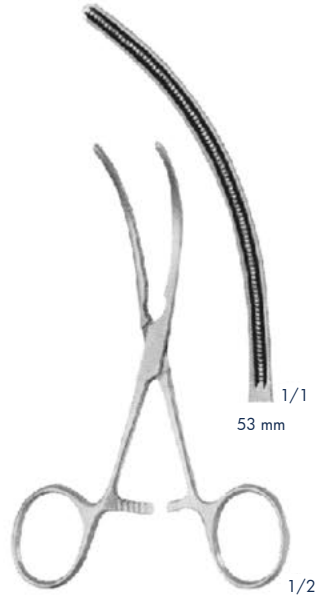

DE BAKAY
OSI200240
curved jaws
125 mm

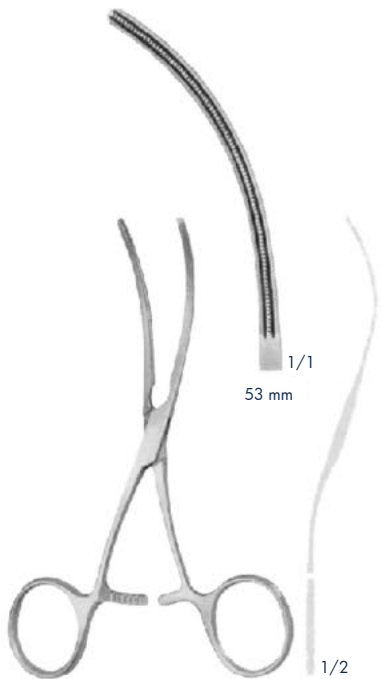

DE BAKAY
OSI200242
S-shaped
125 mm

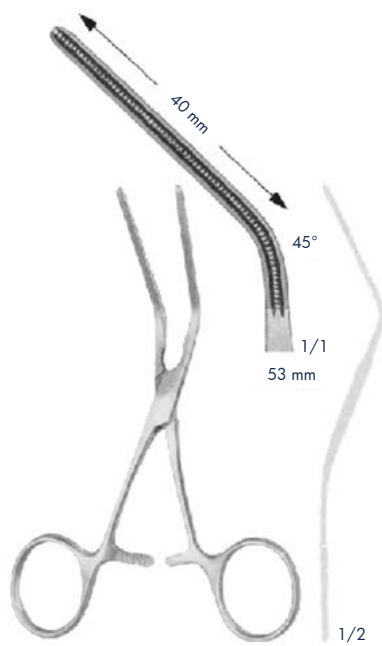

DE BAKAY
OSI200243
angled 45°
125 mm



DE BAKAY
OSI200239
angled 90°
105 mm

Anastomosis- , Multi-Purpose-Clamps for Neonatales

ATRAUMATIC



CASTANEDA
OSI200351 - OSI200352
120 mm



OSI200351

OSI200352



CASTANEDA
OSI200353 - OSI200356
155 mm



OSI200353

OSI200354

OSI200355

OSI200356

Abastomosis-, Multi-Purpose-Clamps for Neonatales

ATRAUMATIC

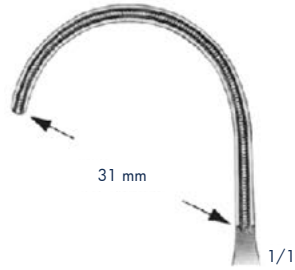

OSI200234
160 mm

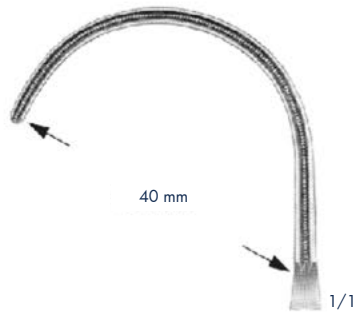

OSI200233
170 mm

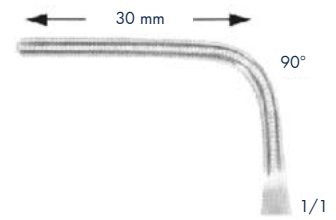

OSI200359
150 mm

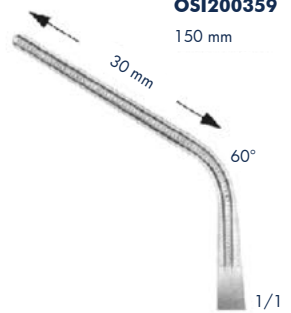

OSI200358
160 mm

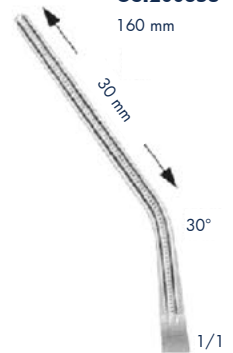

OSI200357
165 mm



DE BAKEY
OSI200234 - OSI200233



COOLEY
OSI200357 - OSI200359

Anastomosis-, Multi-Purpose, Clamps - Pediatric patterns

ATRAUMATIC

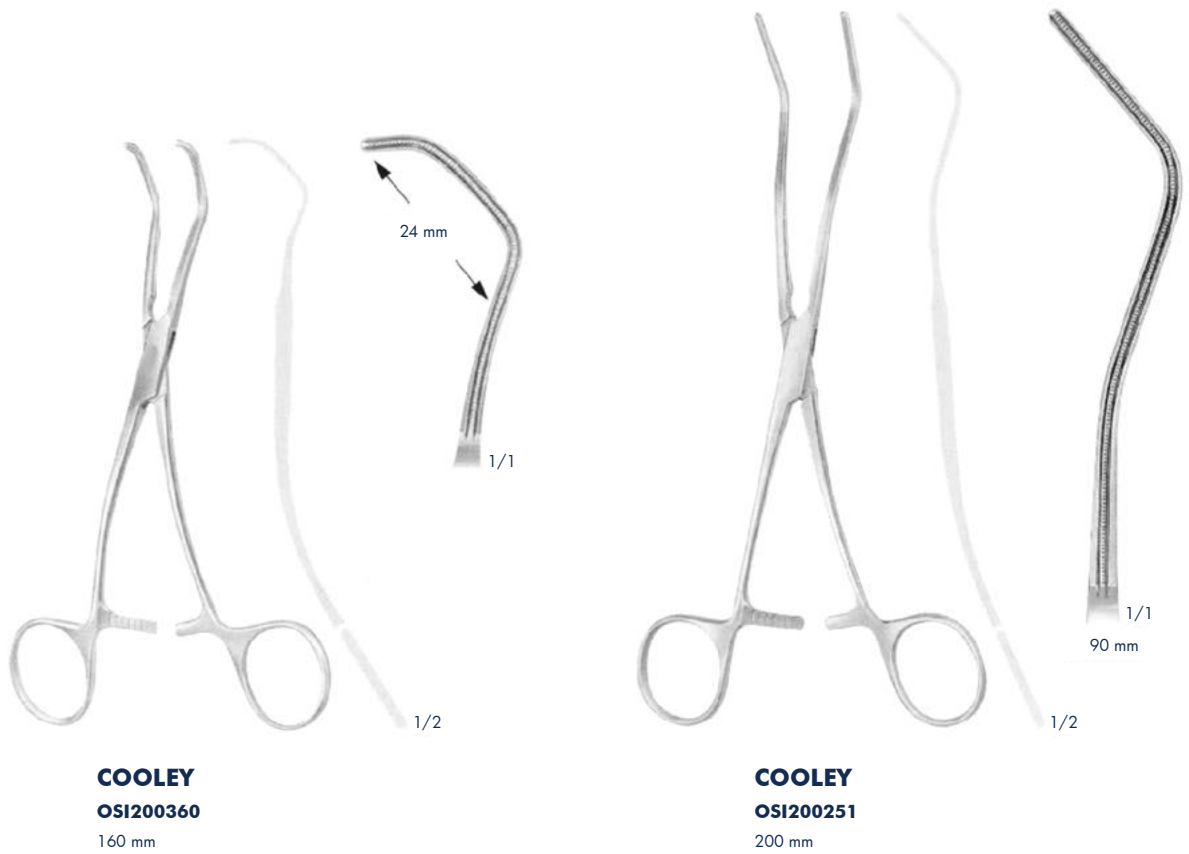

Non-traumatic Hemostatic Forceps

ATRAUMATIC

Mosquito Forceps



OSI200361 - OSI200362
125 mm



OSI200363 - OSI200364
165 mm



DE BAKAY-BAINBRIDGE
OSI200168 - OSI200170
155 mm



DE BAKAY-BAINBRIDGE
OSI200169 - OSI200171
180 mm

Non-traumatic Hemostatic Forceps

ATRAUMATIC



OSI200218
50 mm

OSI200223
50 mm

PEAN
OSI200218 - OSI200223
155 mm

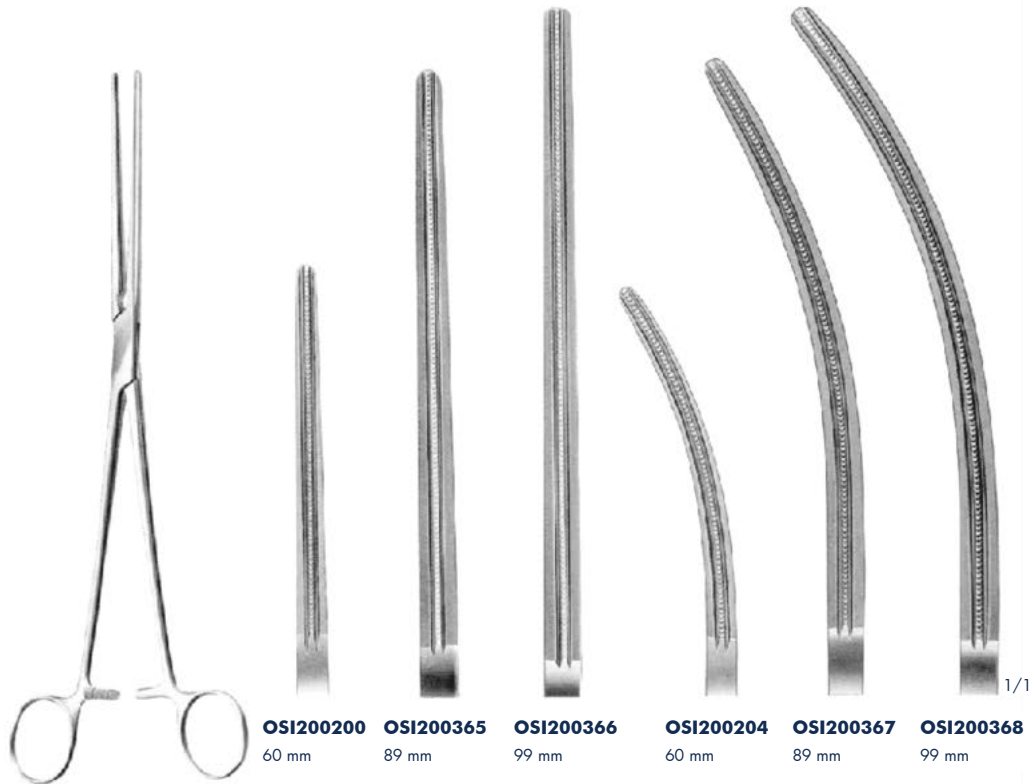

OSI200200
60 mm

OSI200365
89 mm

OSI200366
99 mm

OSI200204
60 mm

OSI200367
89 mm

OSI200368
99 mm

DE BAKEY-PEAN
OSI200200 200 mm
OSI200365 265 mm
OSI200366 280 mm

DE BAKEY-PEAN
OSI200204 200 mm
OSI200367 260 mm
OSI200368 275 mm

Kidney and Pankreas Clamps

ATRAUMATIC

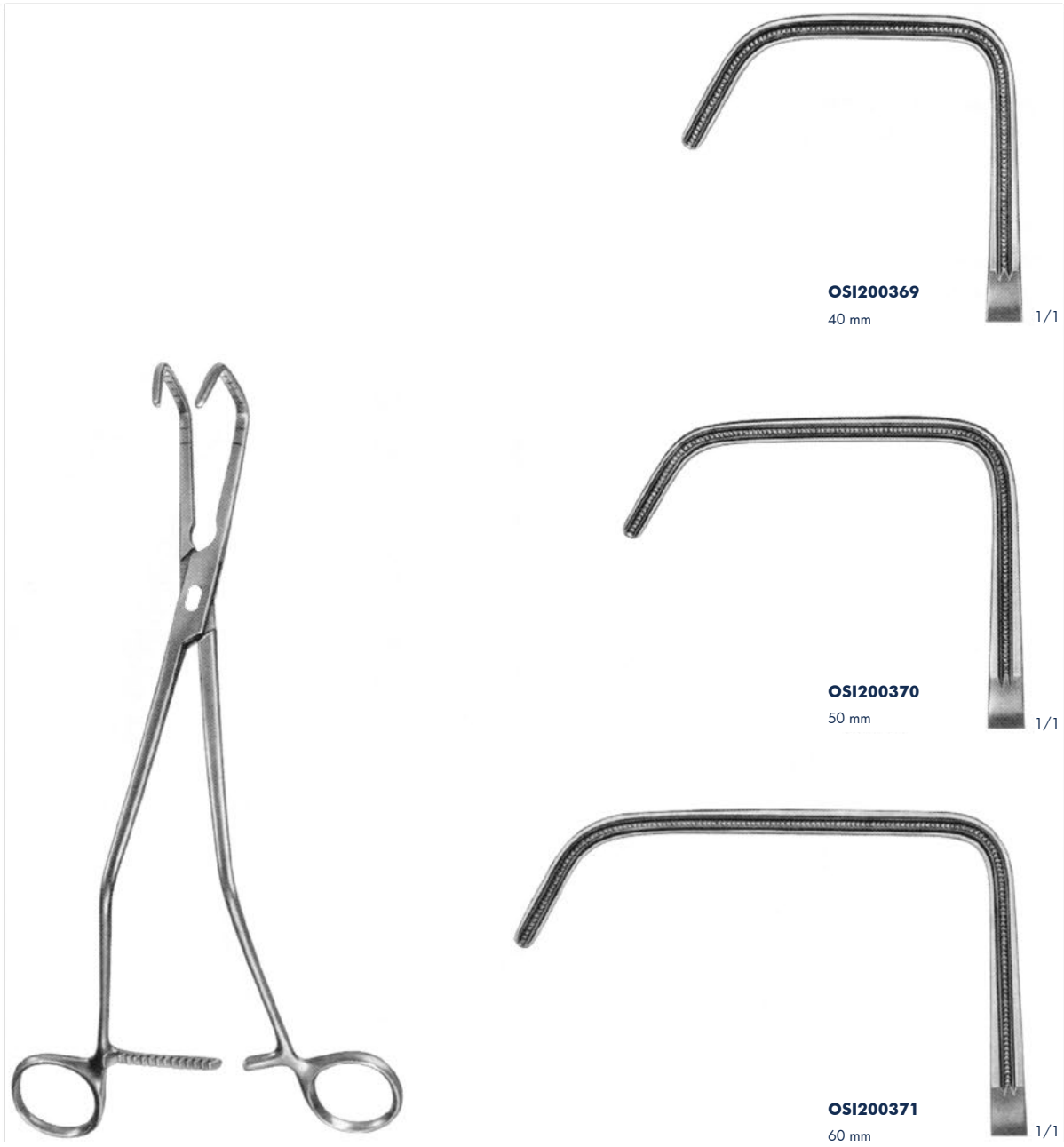

HOPT

- OSI200369** 230 mm
- OSI200370** 235 mm
- OSI200371** 245 mm

Dissecting- and Ligature Forceps

ATRAUMATIC



OSI200372 81 mm
OSI200373 81 mm



1/1
 80 mm



1/1
 70 mm



DE BAKEY-RUMEL
OSI200372 250 mm
OSI200373 245 mm



DE BAKEY-MIXTER
OSI200374
 285 mm



DE BAKEY-MC QUIGG-MIXTER
OSI200375
 210 mm

Dissecting- and Ligature Forceps

ATRAUMATIC



DE BAKEY

OSI200160 190 mm
OSI200161 230 mm



OSI200160
77 mm

OSI200161
80 mm

1/1

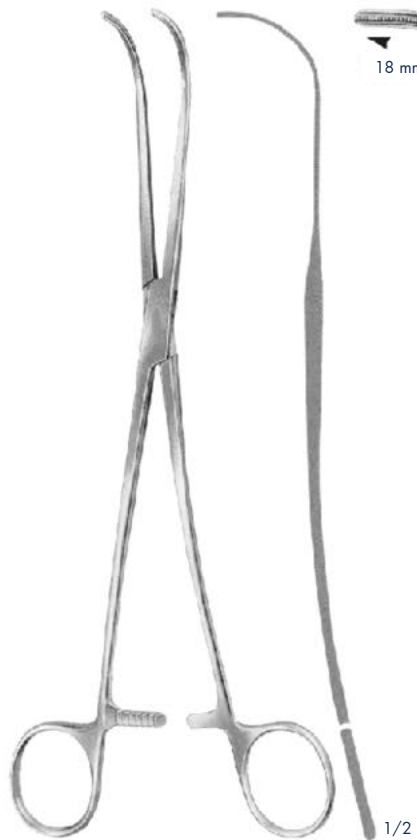

DE BAKEY

OSI200177
240 mm



18 mm
 94 mm

1/2



DE BAKEY

OSI200376 210 mm
OSI200377 230 mm

OSI200376
51 mm

OSI200377
75 mm

1/1

Anastomosis Clamps

ATRAUMATIC



GLOVER
OSI200378 195 mm
OSI200379 210 mm

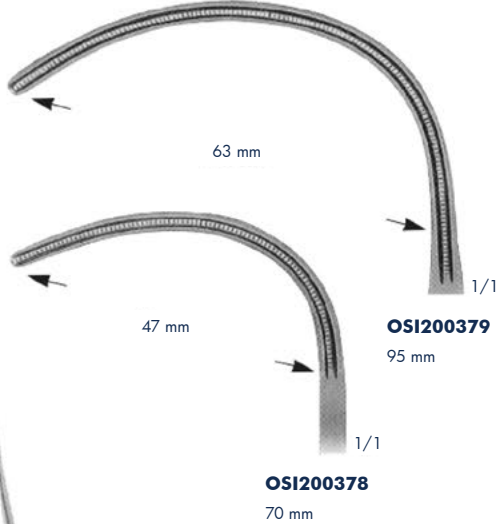

OSI200378
 70 mm

OSI200379
 95 mm



GLOVER
OSI200380 220 mm



1/1
 60 mm



GLOVER
OSI200381 215 mm



1/1
 65 mm



GLOVER
OSI200382 245 mm



1/1
 86 mm

Vena Cava Clamps

ATRAUMATIC

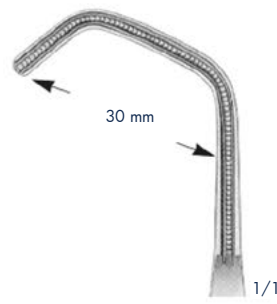

OSI200383
65 mm

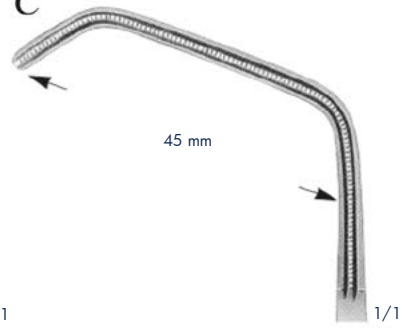

OSI200384
80 mm

DE BAKEY-BECK

- OSI200383** 205 mm
- OSI200384** 210 mm



OSI200186
86 mm



OSI200187
86 mm



OSI200188
86 mm

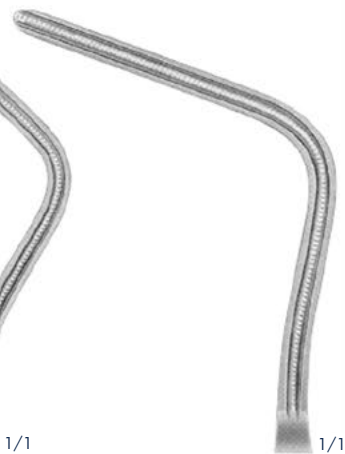

OSI200189
86 mm

DE BAKEY-HARKEN

- OSI200186** 255 mm
- OSI200187** 245 mm
- OSI200188** 245 mm
- OSI200189** 245 mm

Tangential Occlusion Clamps

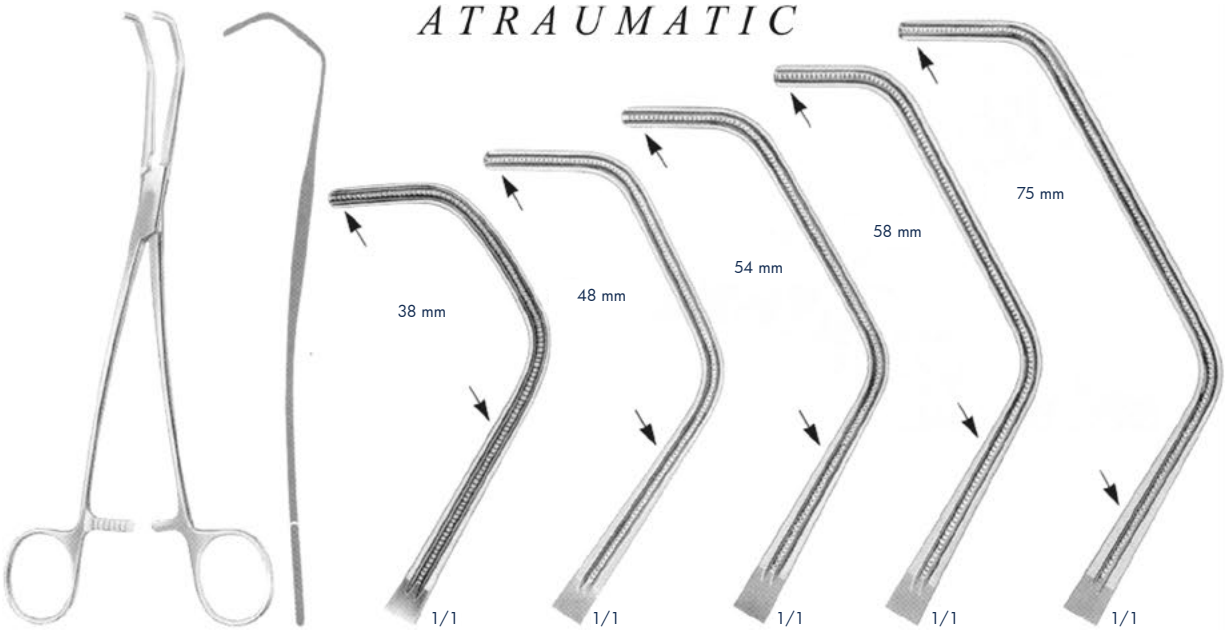

DA BAKEY

OSI200385 - OSI200389

OSI200385

220 mm

OSI200386

265 mm

OSI200387

270 mm

OSI200388

270 mm

OSI200389

280 mm

Length jaws:

85 mm

95 mm

99 mm

103 mm

119 mm



OSI200390

68 mm

OSI200391

76 mm

OSI200392

84 mm

DE BAKEY-SATINSKY

OSI200390 235 mm

OSI200391 240 mm

OSI200392 245 mm

ALLENBERG Hemostatic Forceps

ATRAUMATIC

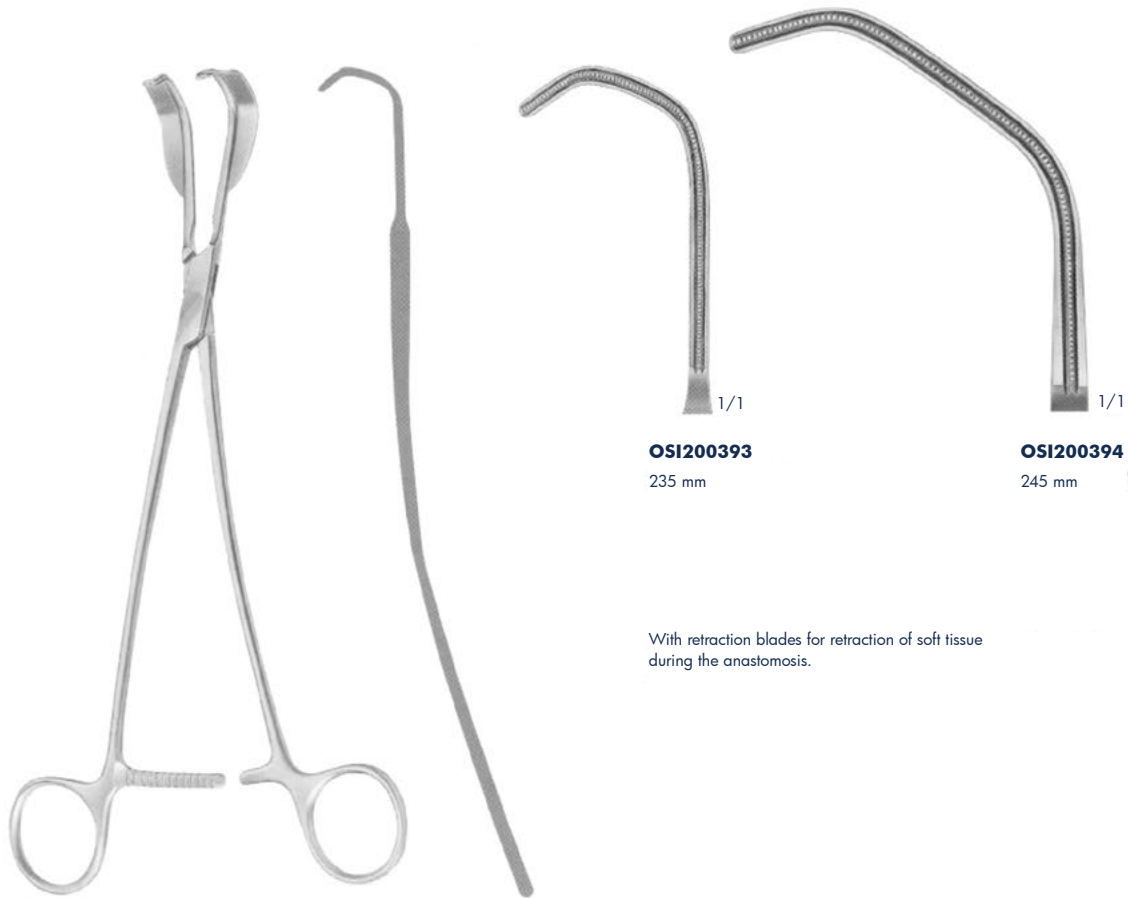

ALLENBERG
OSI200393 - OSI200394

OSI200393
235 mm

OSI200394
245 mm

With retraction blades for retraction of soft tissue during the anastomosis.

Coarctation Clamps

ATRAUMATIC



DE BAKEY

OSI200395 170 mm
OSI200396 165 mm

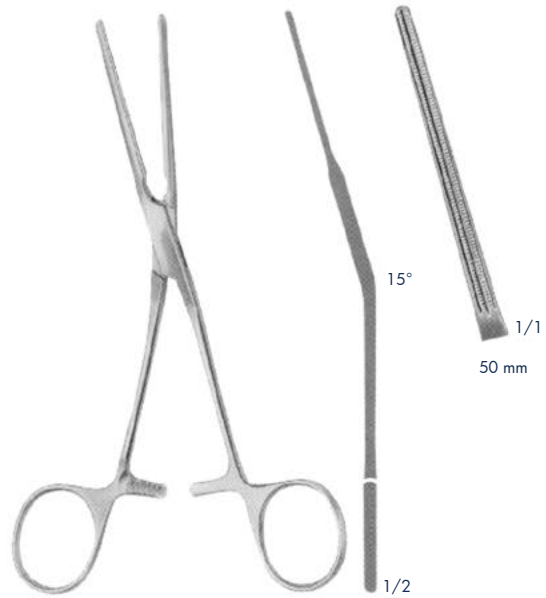

DE BAKEY

OSI200397 165 mm



DE BAKEY

OSI200398 205 mm
OSI200399 225 mm
OSI200400 240 mm



DE BAKEY

OSI200401 200 mm
OSI200402 225 mm
OSI200403 240 mm

Patent- Ductus- Clamps, Peripheral-Vascular- Clamps

ATRAUMATIC

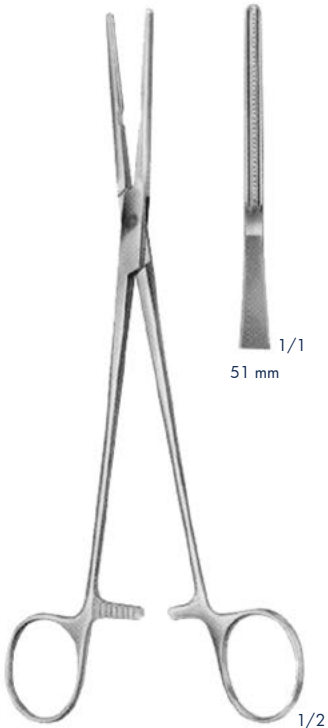

DE BAKEY
OSI200404
210 mm

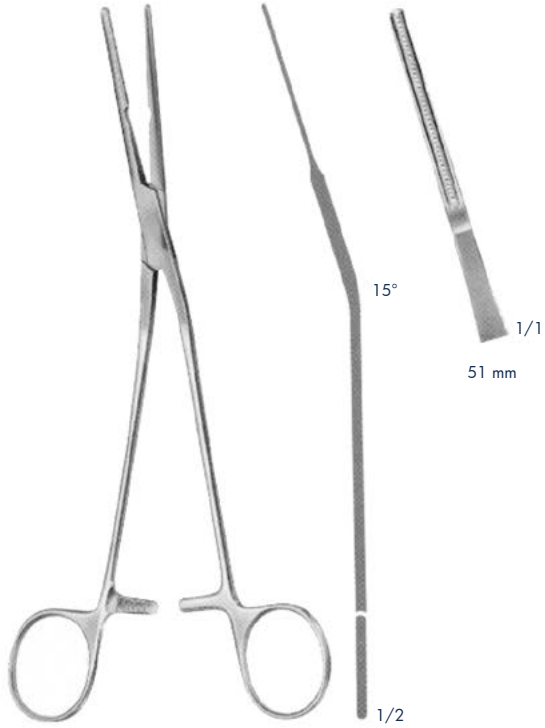

DE BAKEY
OSI200405
210 mm



DE BAKEY
OSI200162
160 mm

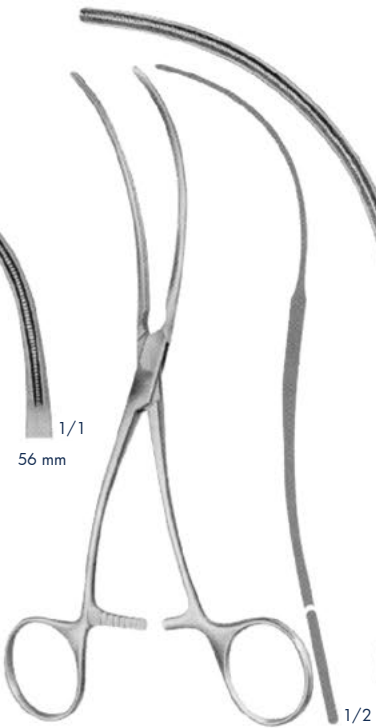

DE BAKEY
OSI200163
190 mm

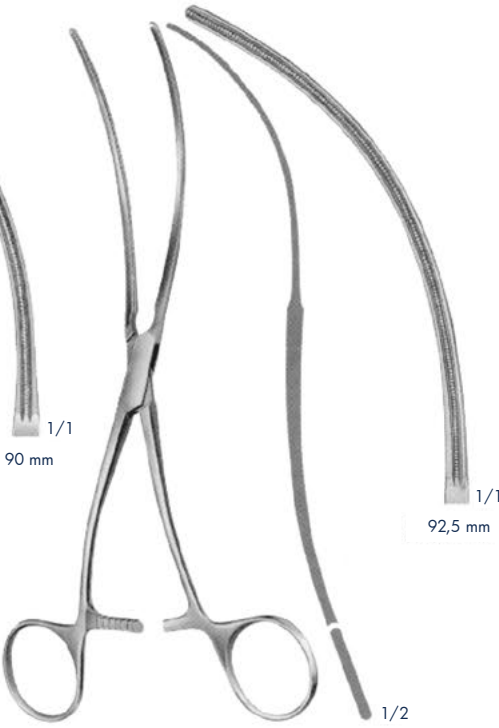

DE BAKEY
OSI200164
200 mm

Peripheral-Vascular- Clamps

ATRAUMATIC

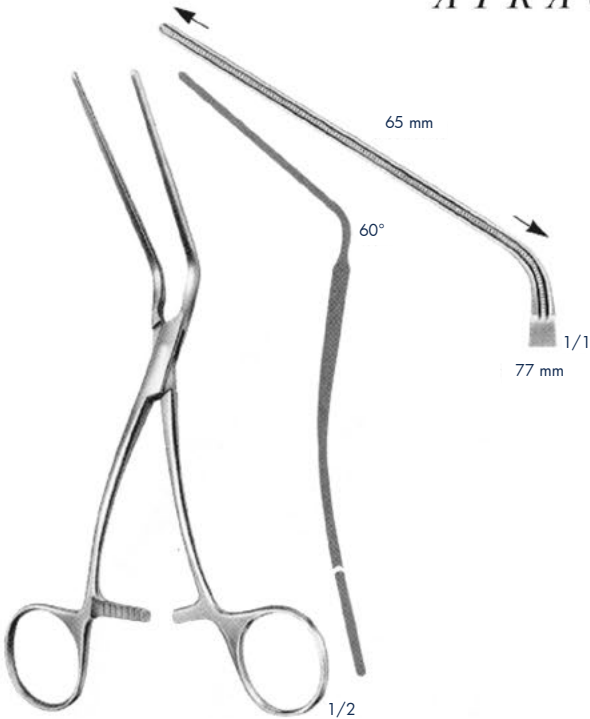

DE BAKEY
OSI200406
180 mm



LELAND-JONES
OSI200166 - OSI200167
190 mm



LELAND-JONES
OSI200407
195 mm

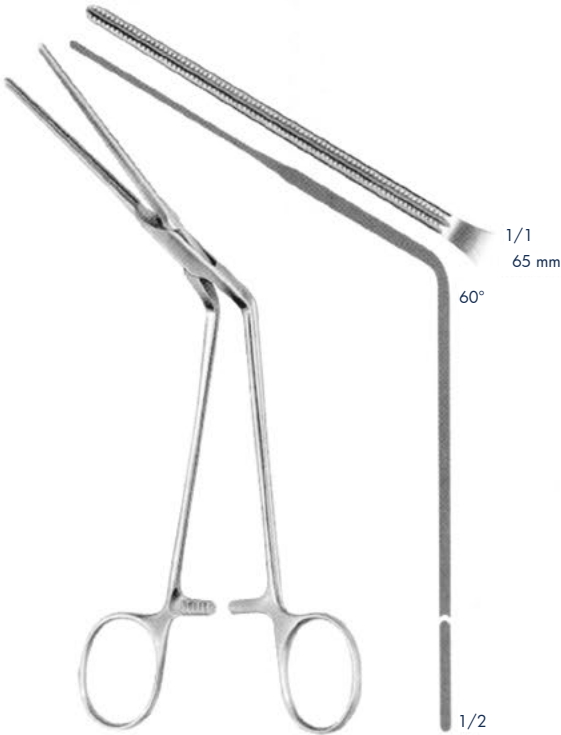

DE BAKEY
OSI200408
200 mm iliac clamp

Anastomosis Clamps

ATRAUMATIC



Multi-Purpose Clamps

ATRAUMATIC

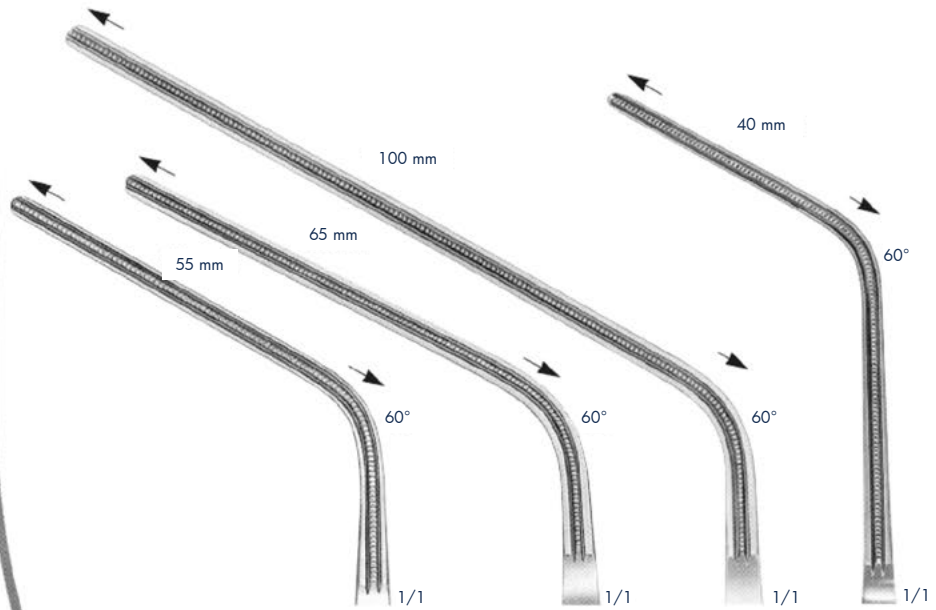

DE BAKEY

	OSI200413	OSI200414	OSI200415	OSI200412
Total Length	230 mm	280 mm	305 mm	240 mm
Length jaws:	85 mm	100 mm	135 mm	93 mm

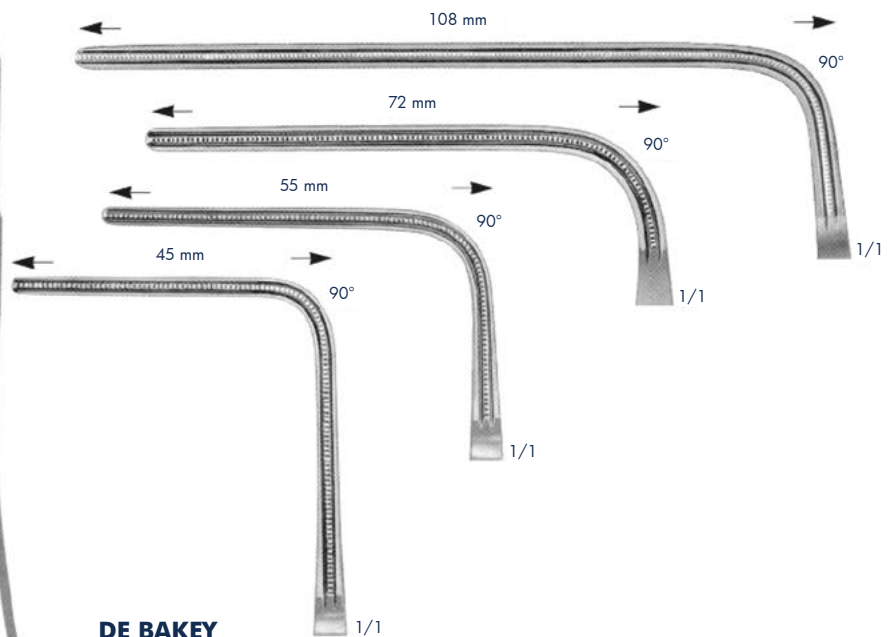

DE BAKEY

	OSI200416	OSI200417	OSI200418	OSI200419
Total Length	225 mm	210 mm	255 mm	275 mm
Length jaws:	93 mm	85 mm	92 mm	134 mm

Ascending Aorta Cross Clamps

ATRAUMATIC



MORRIS
OSI200420
175 mm

DE BAKEY
(MORRIS modif.)
OSI200421
240 mm

Bronchus Clamps

ATRAUMATIC



LEES
OSI200190
220 mm



LEES
OSI200192
245 mm

Aorta-Aneurysm-Clamps

ATRAUMATIC

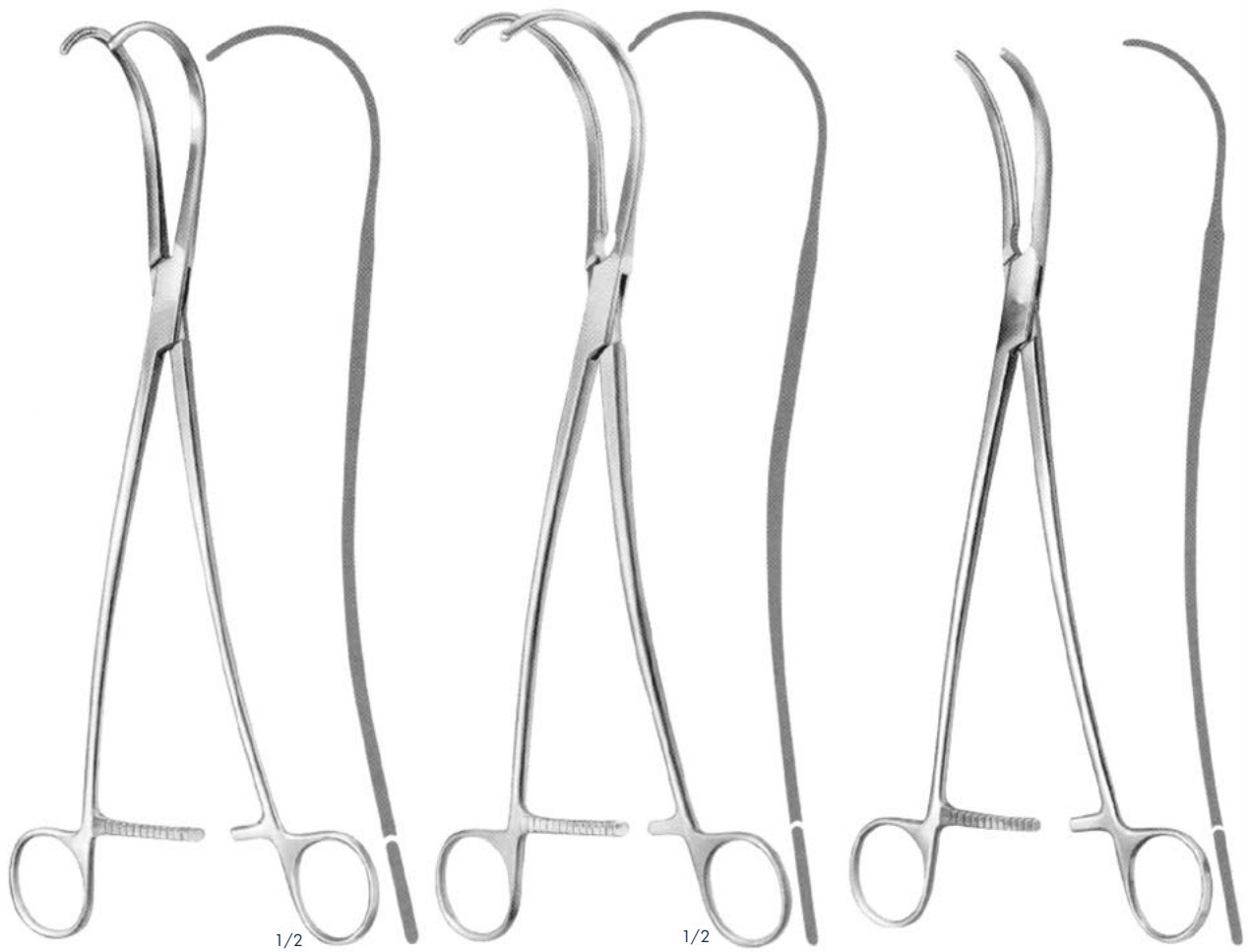
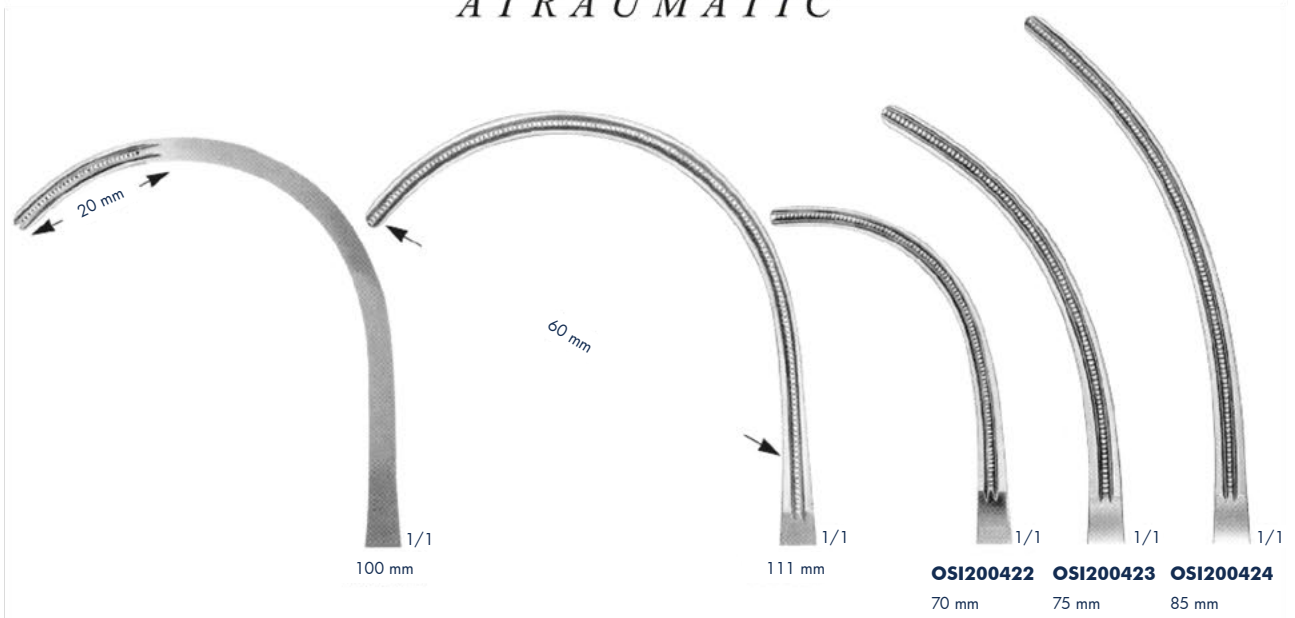

DE BAKEY (SEMB modif.)
OSI200180
265 mm

DE BAKEY
OSI200179
270 mm

DE BAKEY
OSI200422 255 mm
OSI200423 265 mm
OSI200424 280 mm

Aorta-Aneurysm-Clamps

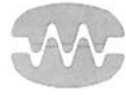

ATRAUMATIC

2 : 3 Teeth rows

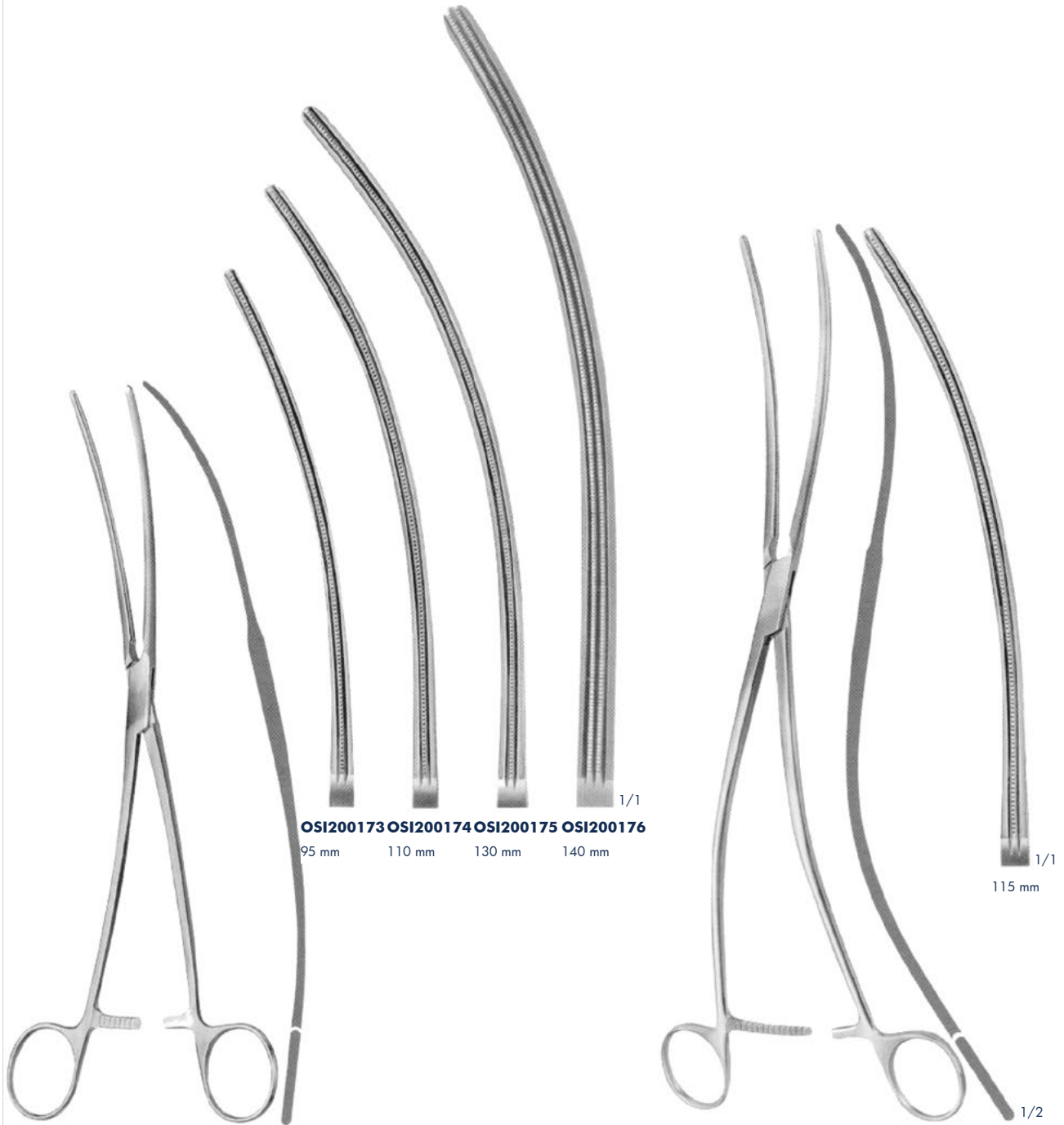

OSI200173 95 mm
OSI200174 110 mm
OSI200175 130 mm
OSI200176 140 mm

1/1
 115 mm

1/2

DE BAKY

- OSI200173** 250 mm
- OSI200174** 300 mm
- OSI200175** 315 mm
- OSI200176** 330 mm

DE BAKY

- OSI200425** 300 mm

Aorta Clamps

ATRAUMATIC

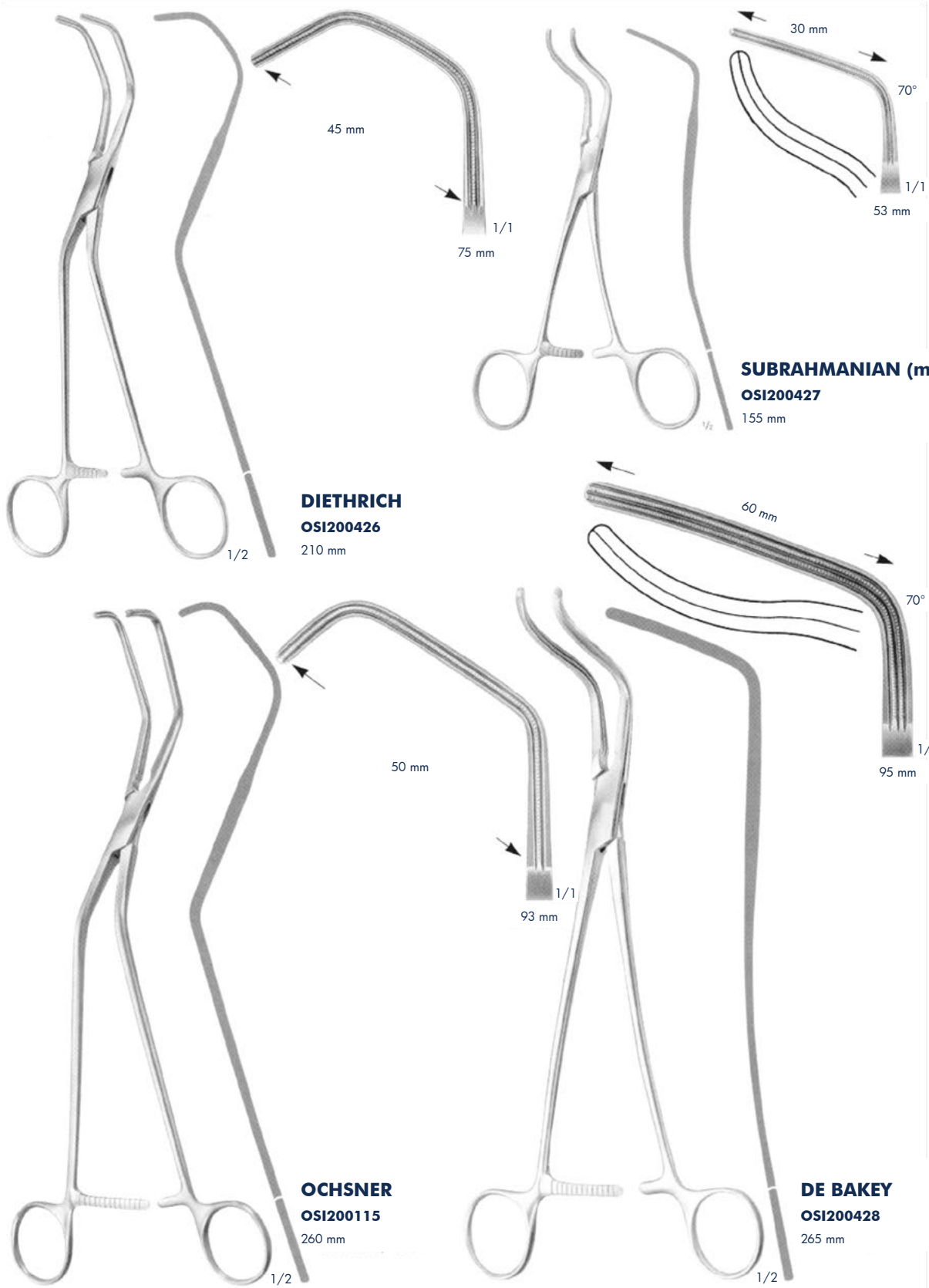

Aorta-Anastomosis Clamps

ATRAUMATIC

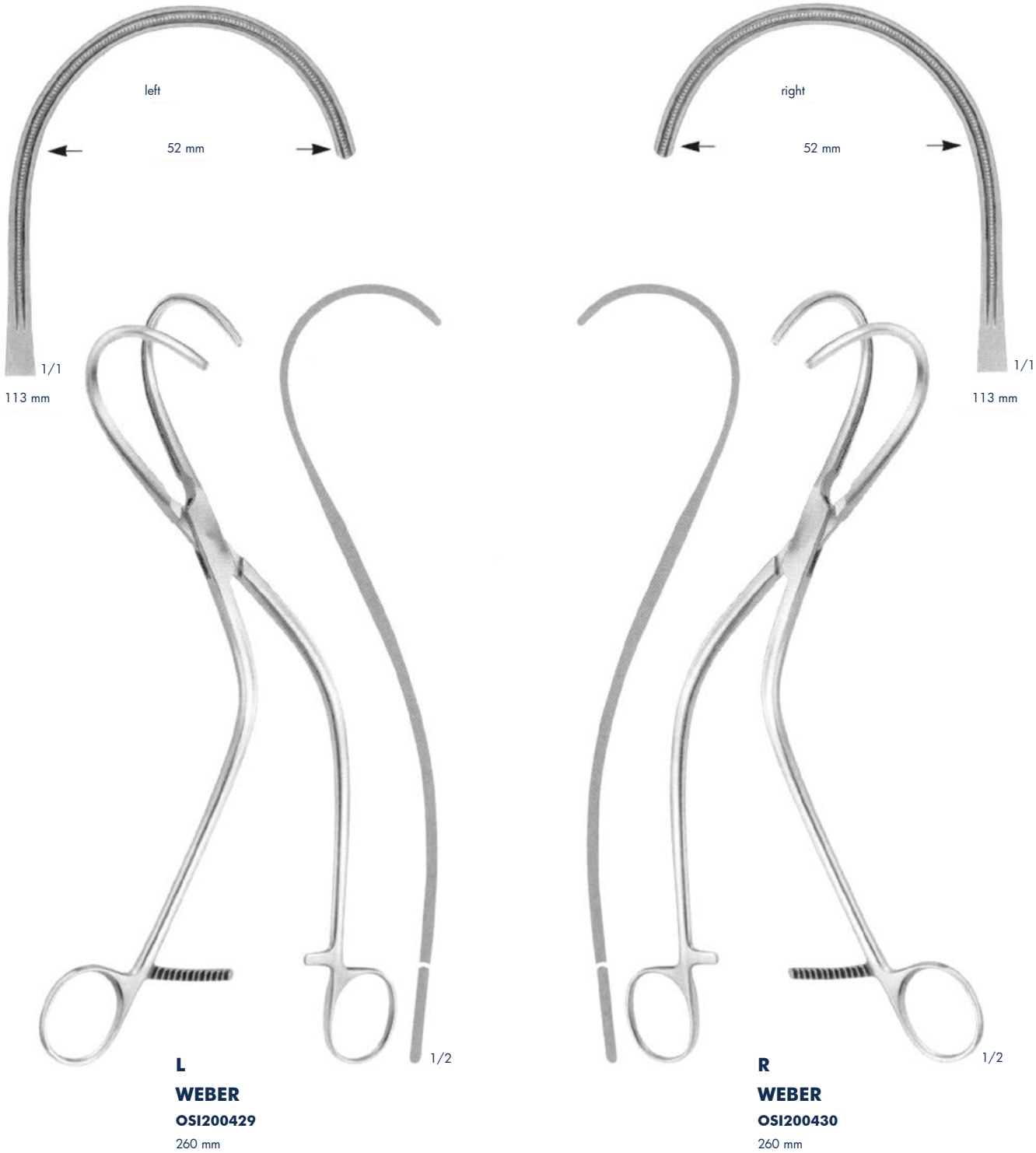

Aorta-Anastomosis Clamps

ATRAUMATIC

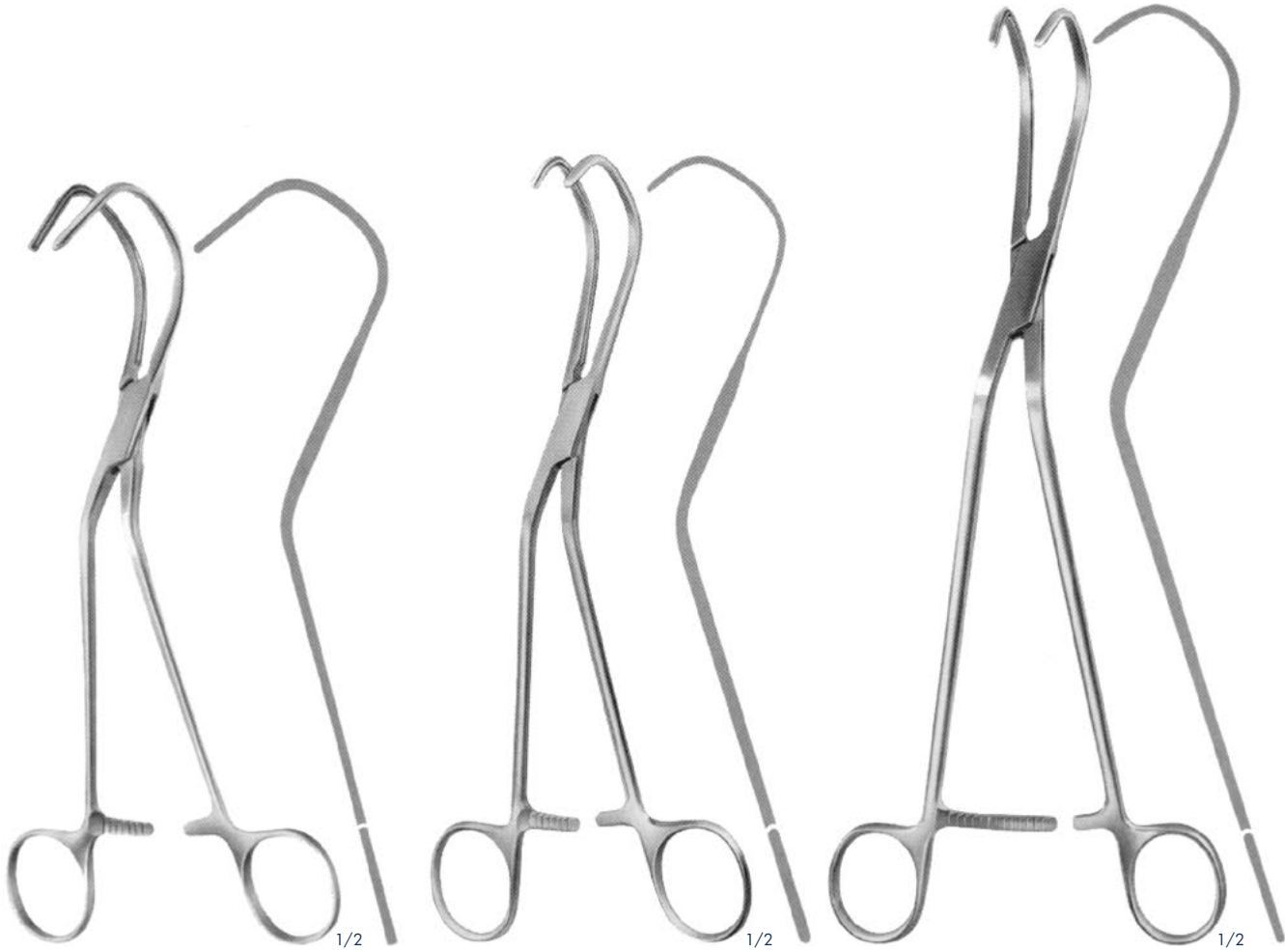
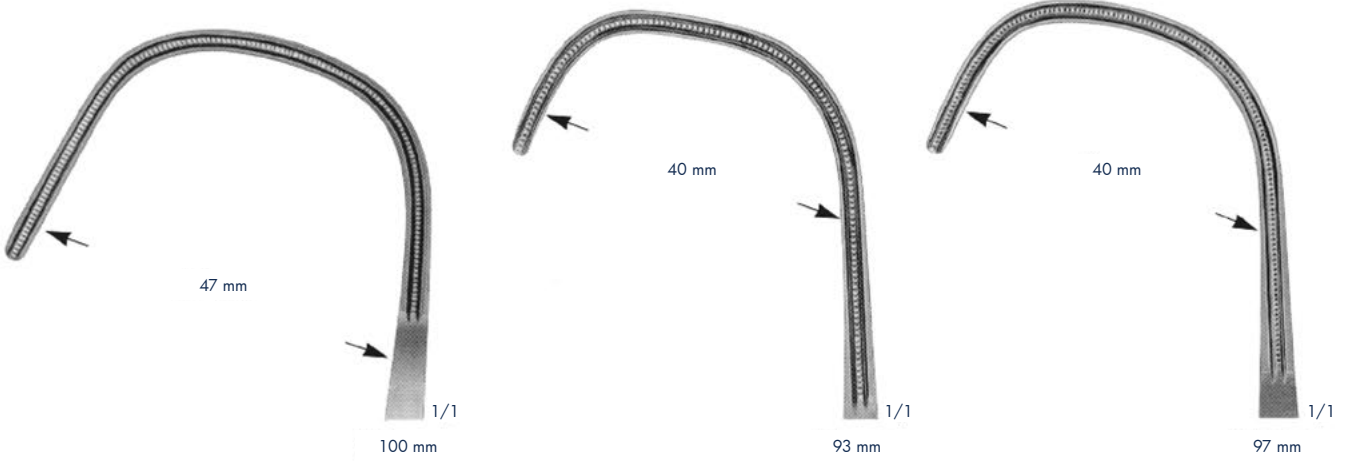

LAMBERT-KAY
OSI200194
 210 mm

LAMBERT-KAY
OSI200431
 215 mm

DE BAKEY
 (LAMBERT modif.)
OSI200193
 255 mm

Ring Handle Bulldog Clamps

ATRAUMATIC



COOLEY
OSI200432 125 mm
OSI200433 115 mm



COOLEY
OSI200434 100 mm

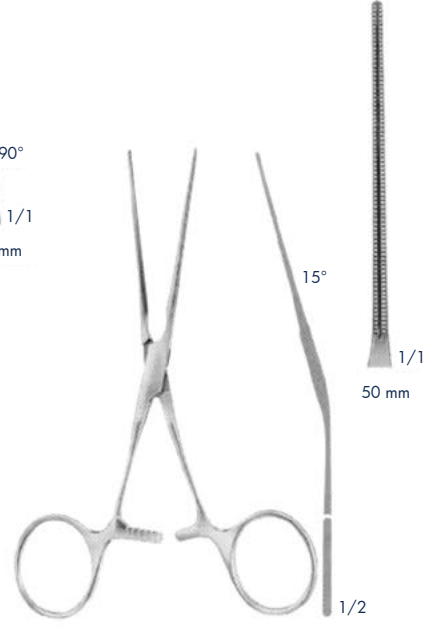

COOLEY
OSI200435 125 mm

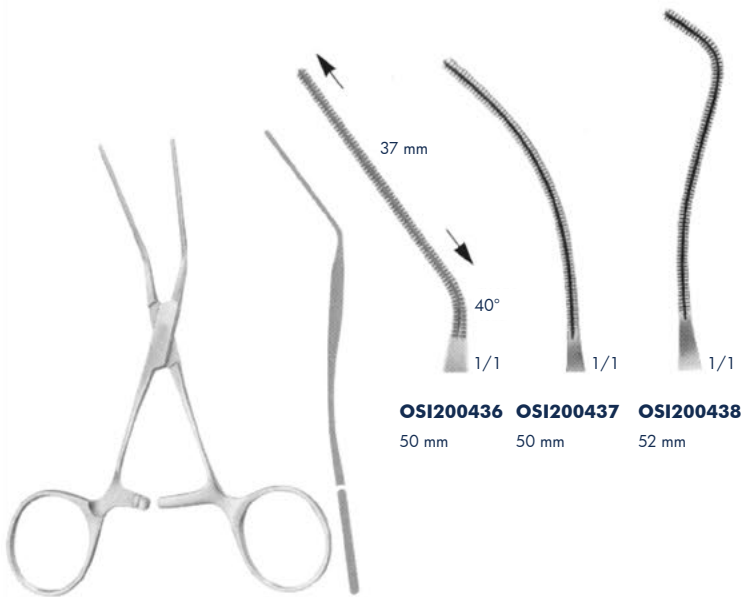

COOLEY
OSI200436 120 mm
OSI200437 125 mm
OSI200438 125 mm



COOLEY
OSI200439 120 mm
OSI200440 115 mm

Ring Handle Bulldog Clamps

ATRAUMATIC



COOLEY
OSI200441
145 mm



COOLEY
OSI200246
140 mm



COOLEY
OSI200248
145 mm

Anastomosis Clamps, Pediatric patterns

ATRAUMATIC

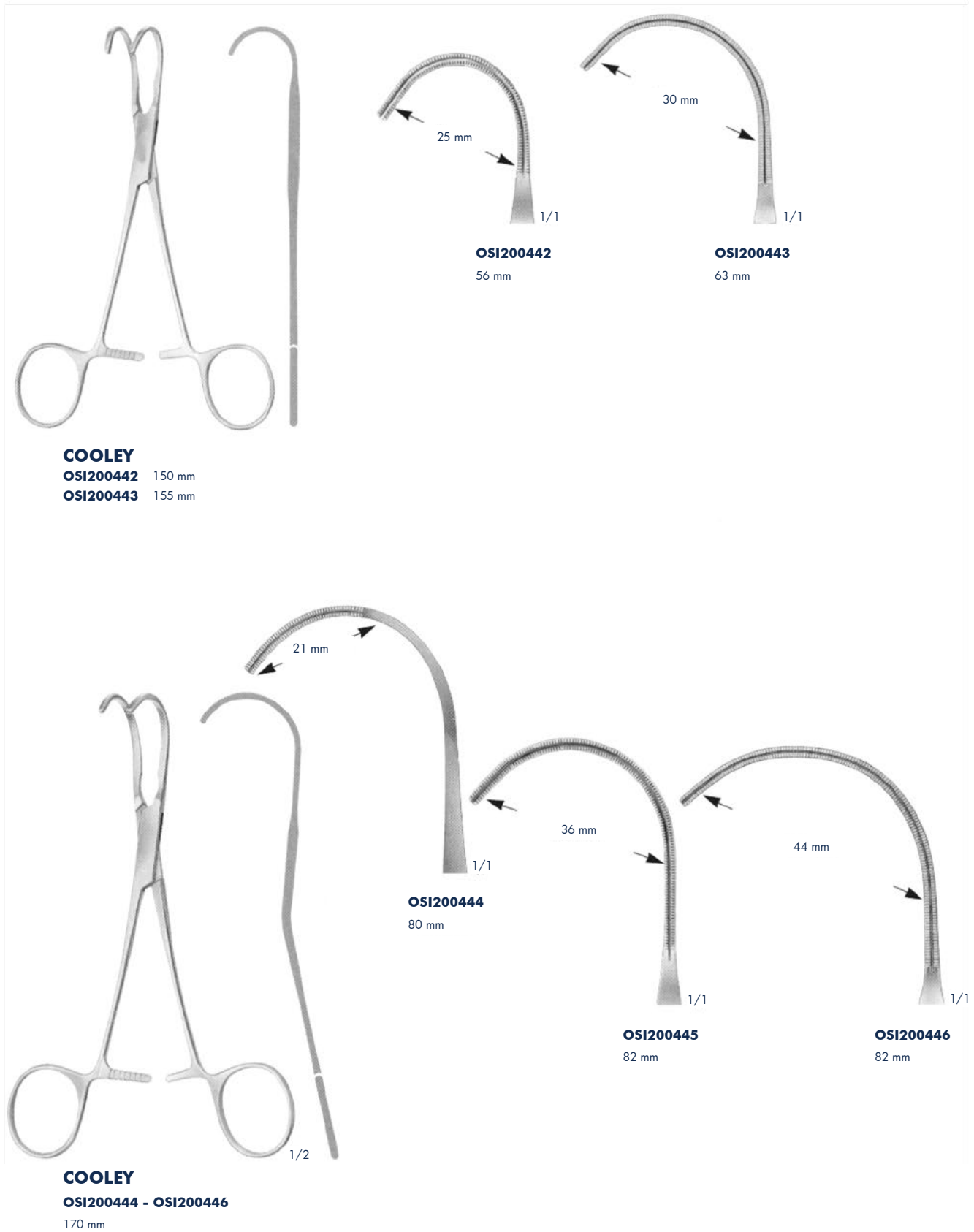

Anastomosis Clamps, Pediatric patterns

ATRAUMATIC

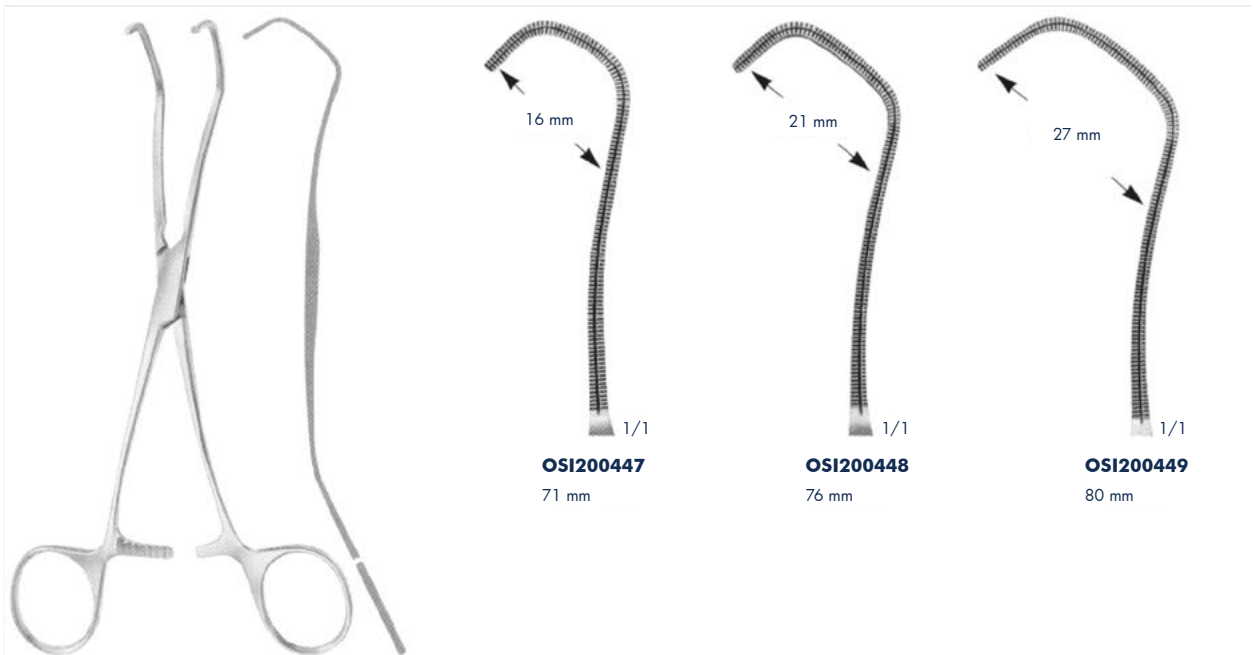

DERRA-COOLEY

- OSI200447** 170 mm
- OSI200448** 175 mm
- OSI200449** 175 mm

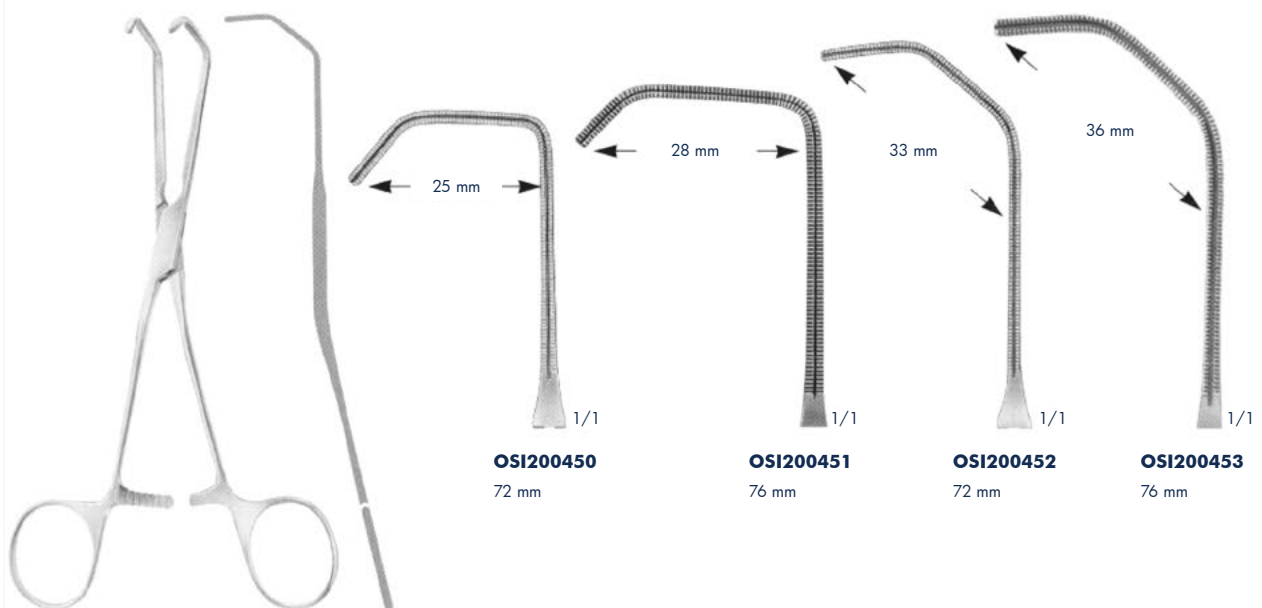

COOLEY

- OSI200450** 165 mm
- OSI200451** 165 mm
- OSI200452** 175 mm
- OSI200453** 180 mm

ATRAUMATIC



COOLEY
OSI200254 - OSI200256

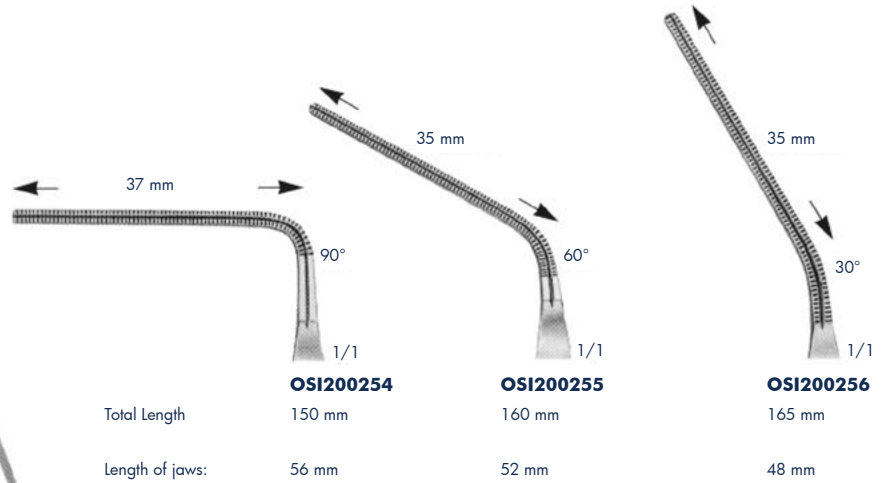

Anastomosis Clamps, Multi-Purpose Clamps

ATRAUMATIC

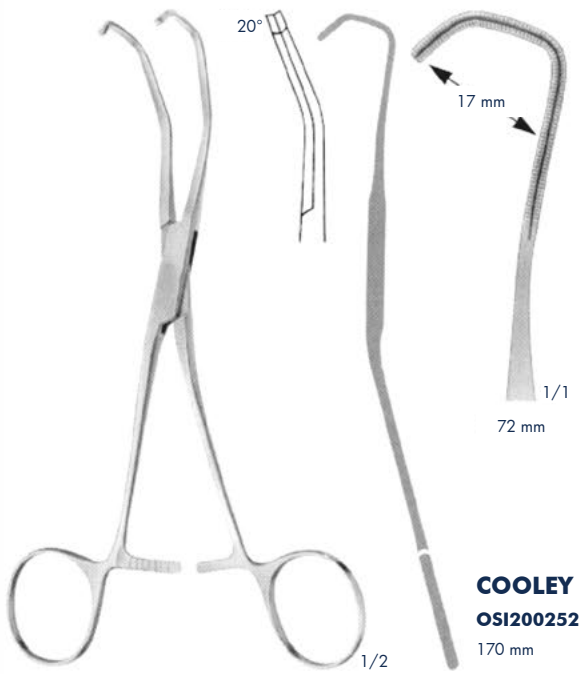

COOLEY
OSI200252
170 mm

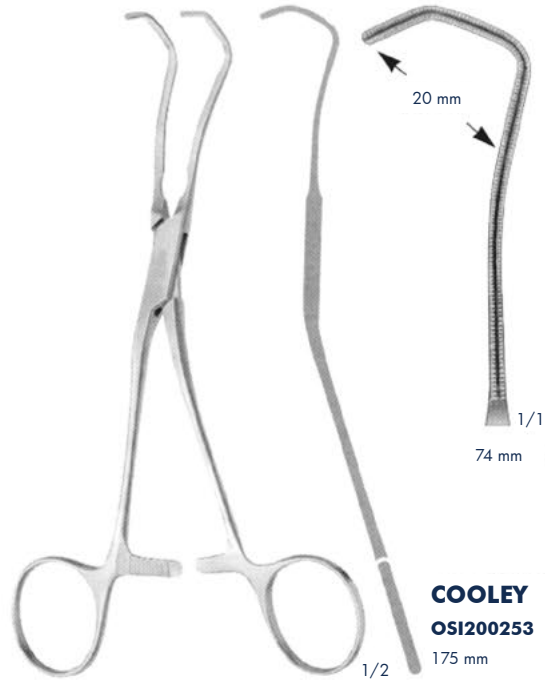

COOLEY
OSI200253
175 mm

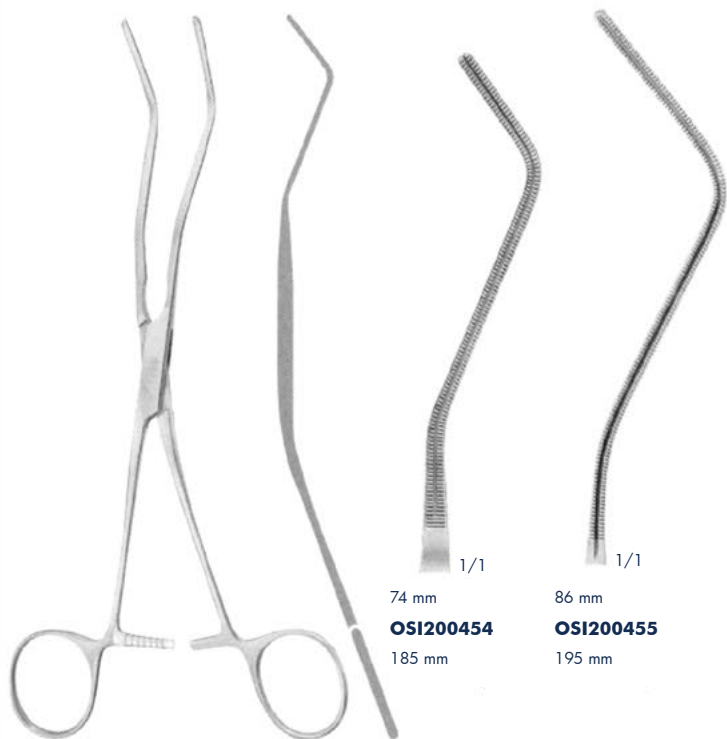

COOLEY
OSI200454 - OSI200455

Ductus Clamps, Coarctations Clamps, Pediatric Types

ATRAUMATIC

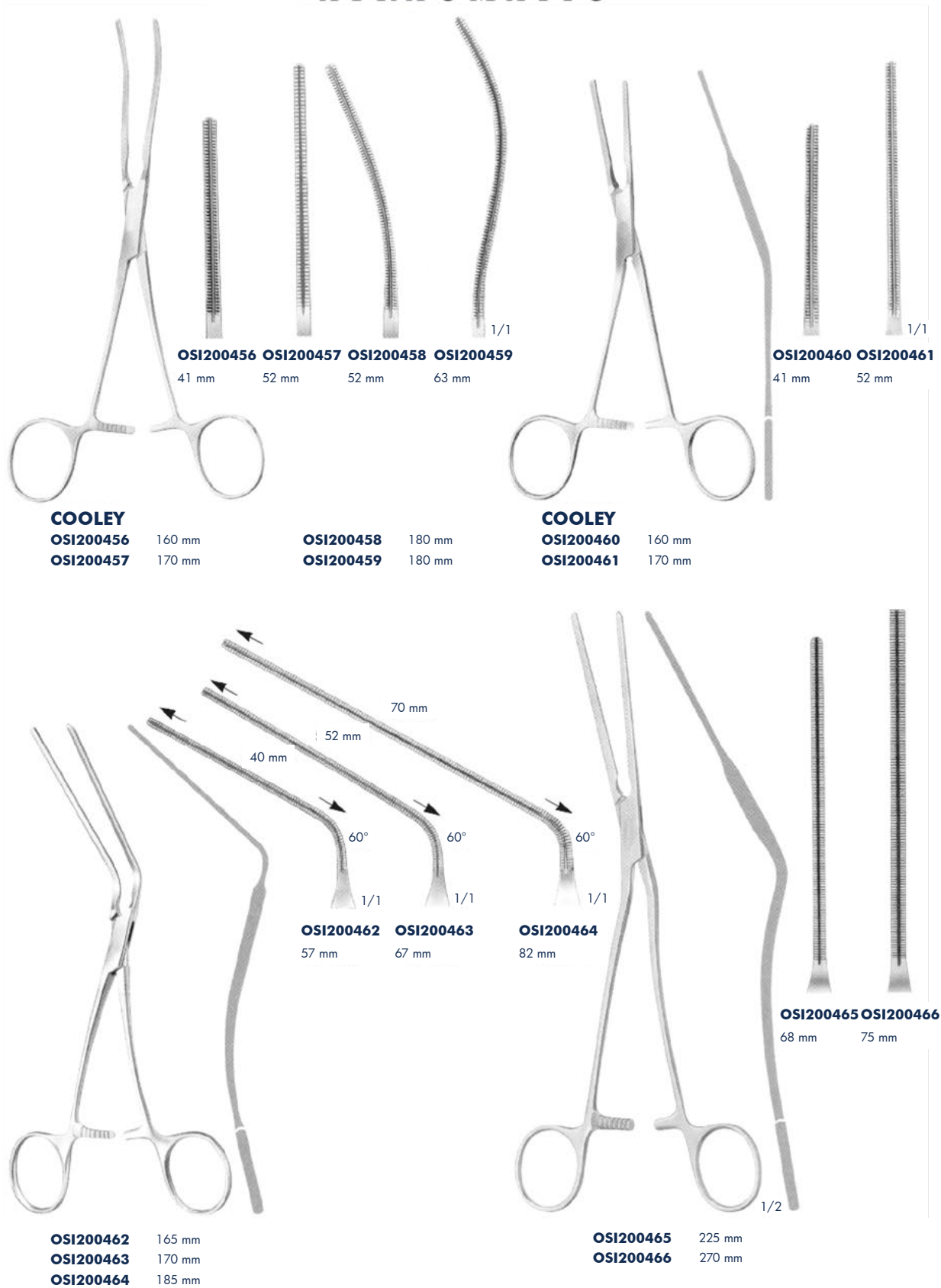

Anastomosis Clamps, Multi-Purpose Clamps

ATRAUMATIC

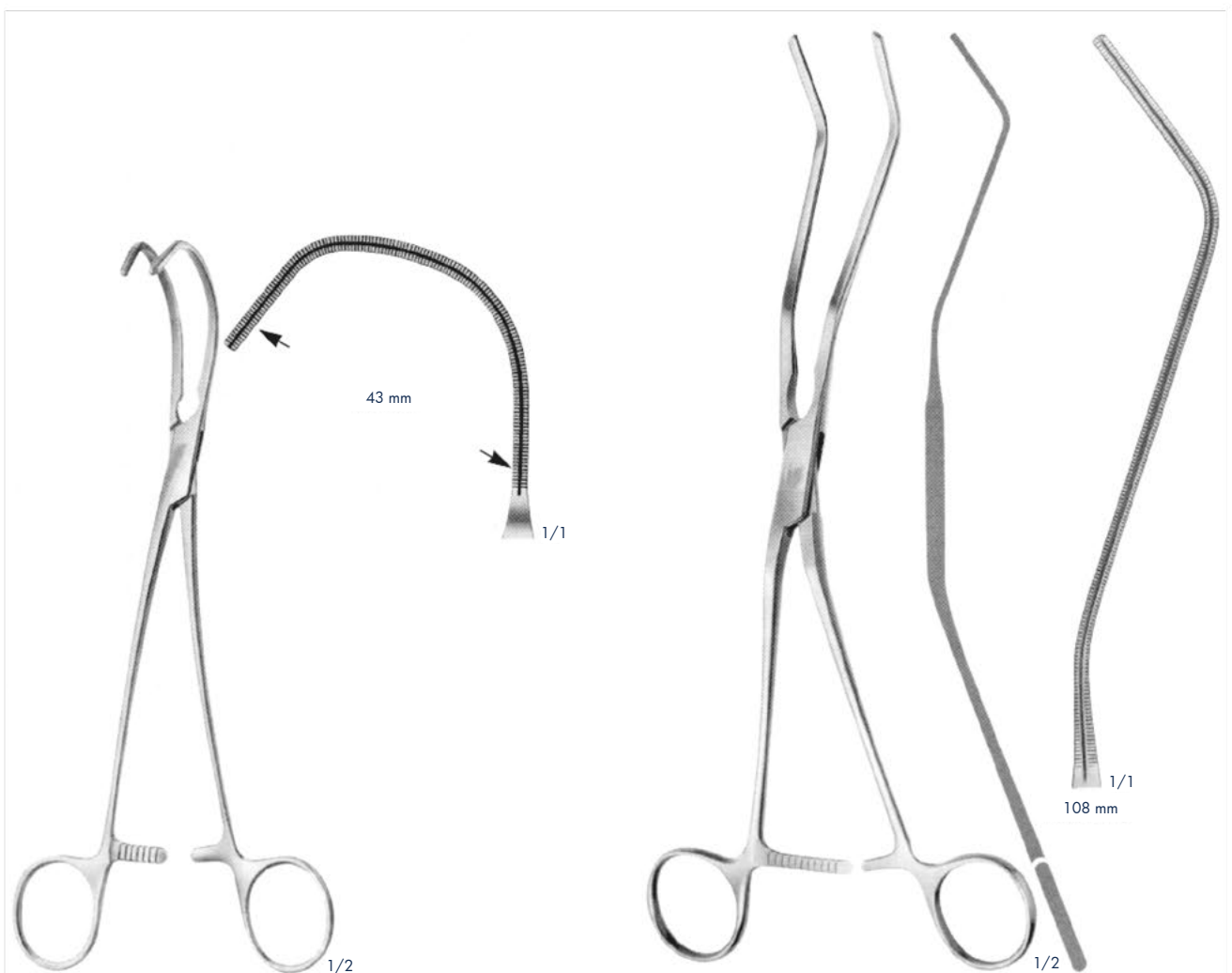

LEITZ
OSI200467
205 mm

COOLEY
OSI200468
260 mm

Anastomosis Clamps

ATRAUMATIC

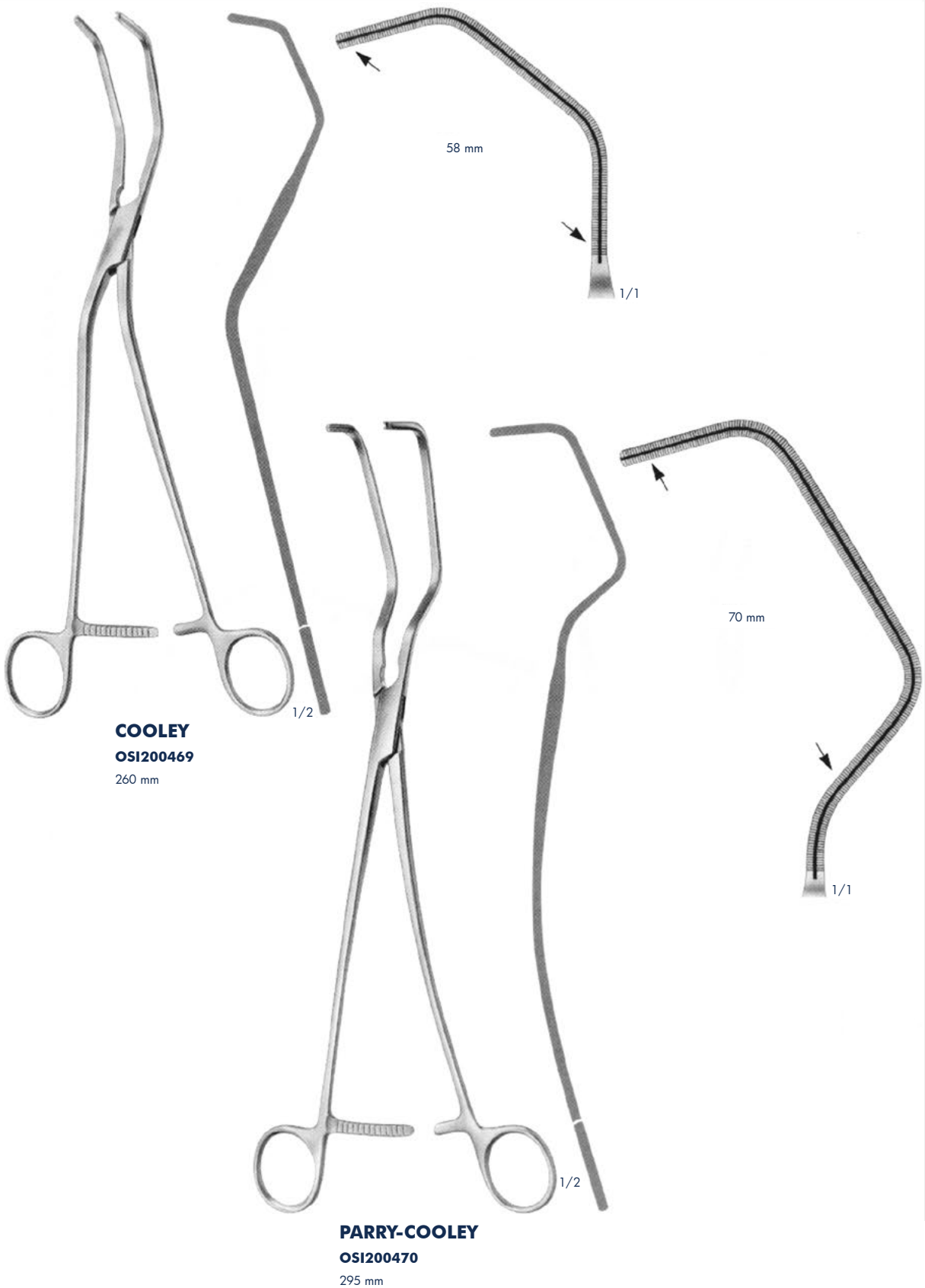

Anastomosis Clamps

ATRAUMATIC

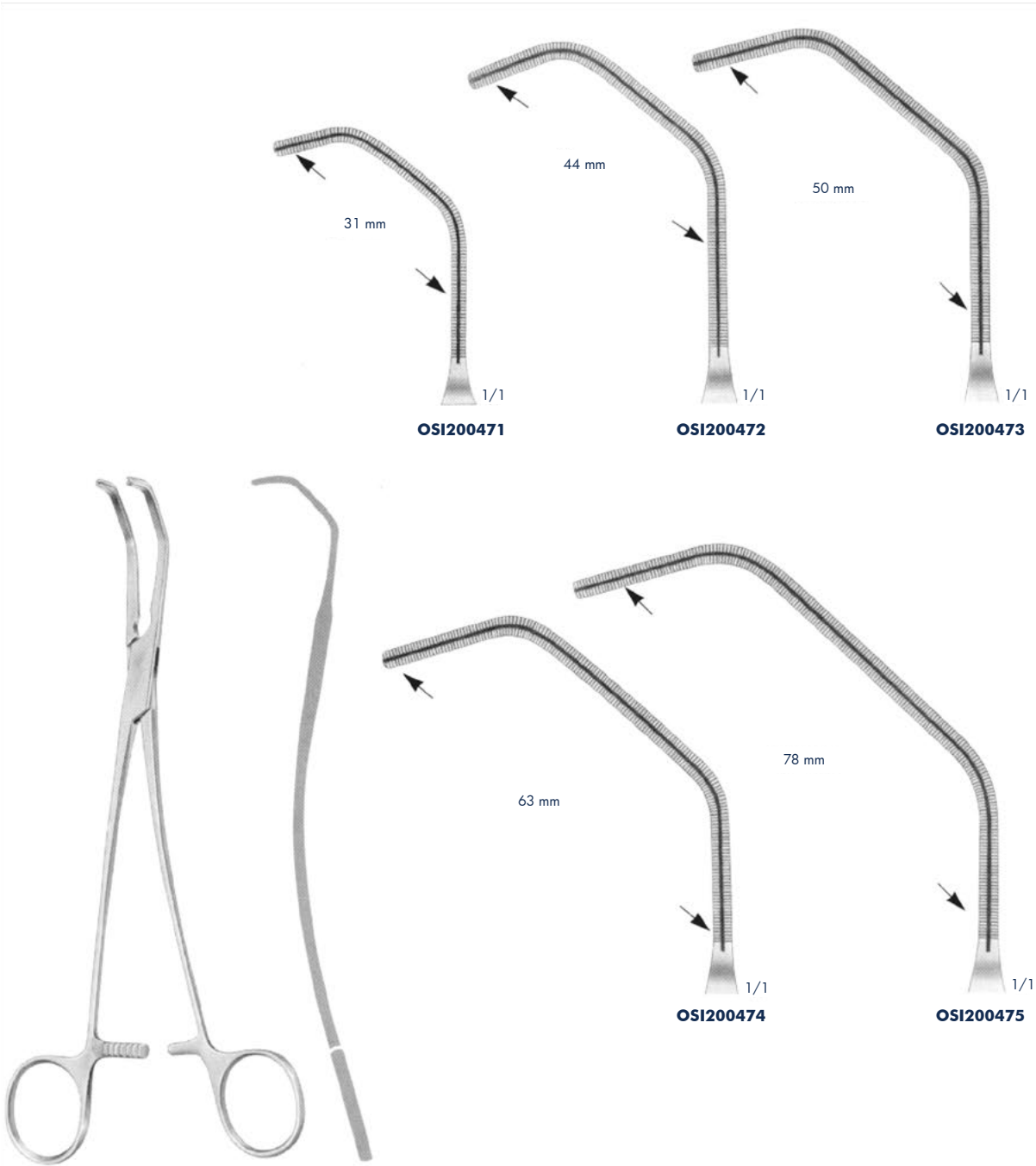

- COOLEY**
- OSI200471** 205 mm
 - OSI200472** 260 mm
 - OSI200473** 265 mm
 - OSI200474** 265 mm
 - OSI200475** 275 mm

Aorta Clamp

ATRAUMATIC

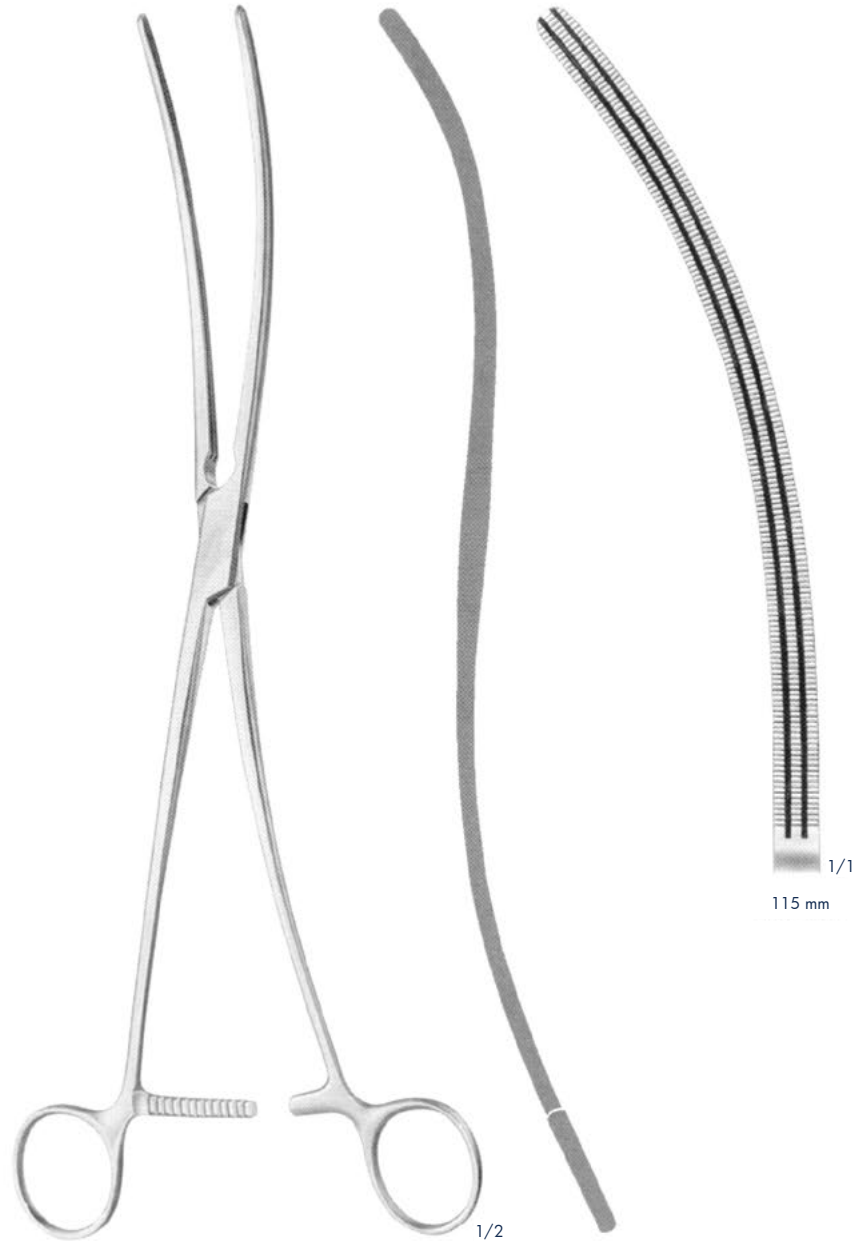

115 mm

COOLEY
OSI200476
320 mm

Multi-Purpose Clamp

ATRAUMATIC

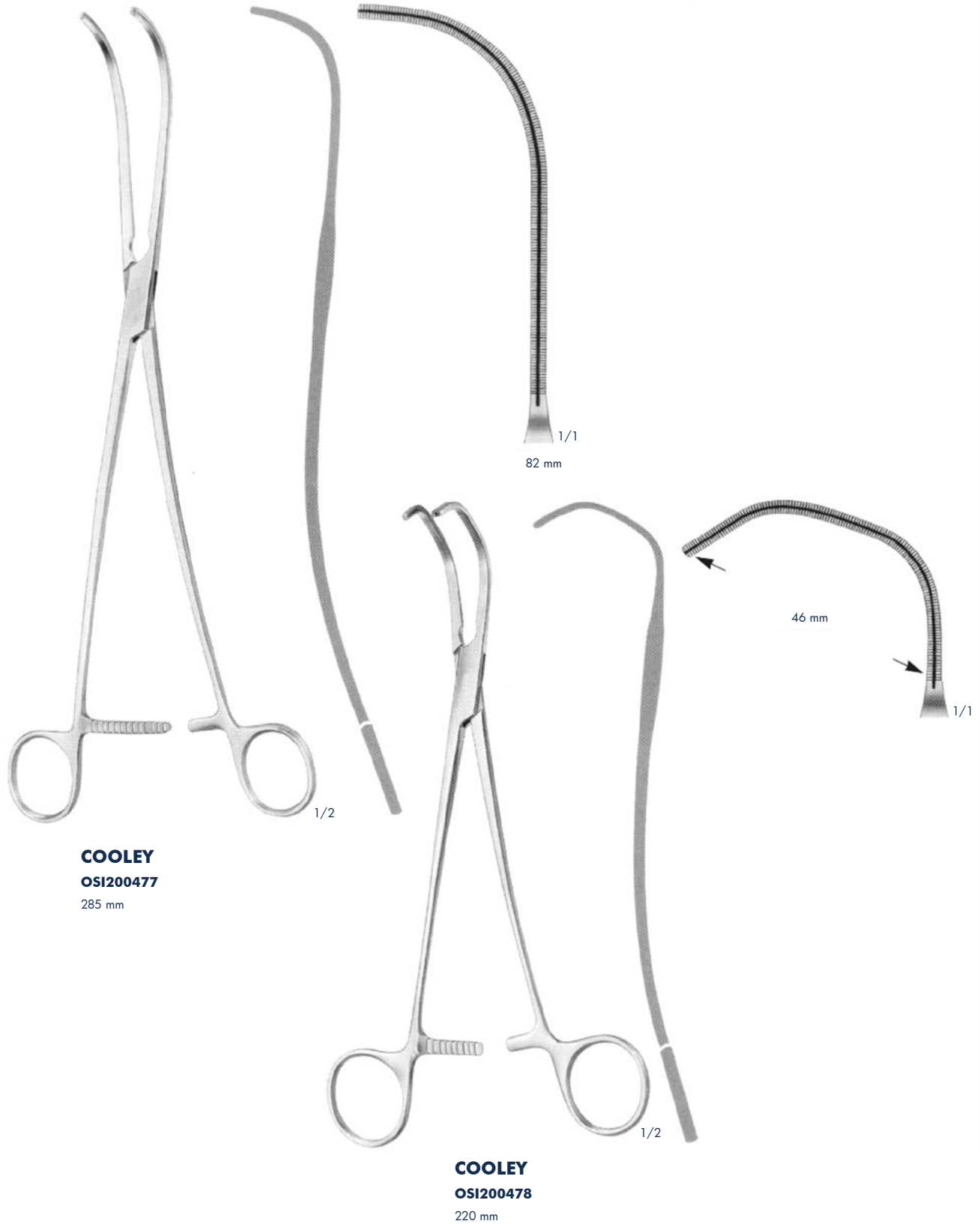

Multi-Purpose Clamp

ATRAUMATIC

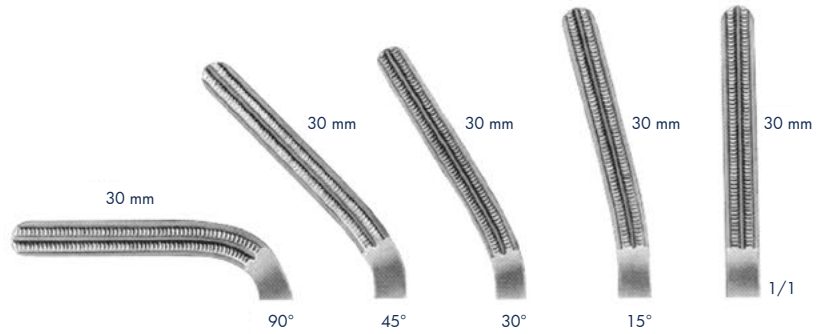

Length of jaws: **OSI200483** 38 mm **OSI200482** 38 mm **OSI200481** 38 mm **OSI200480** 38 mm **OSI200479** 38 mm

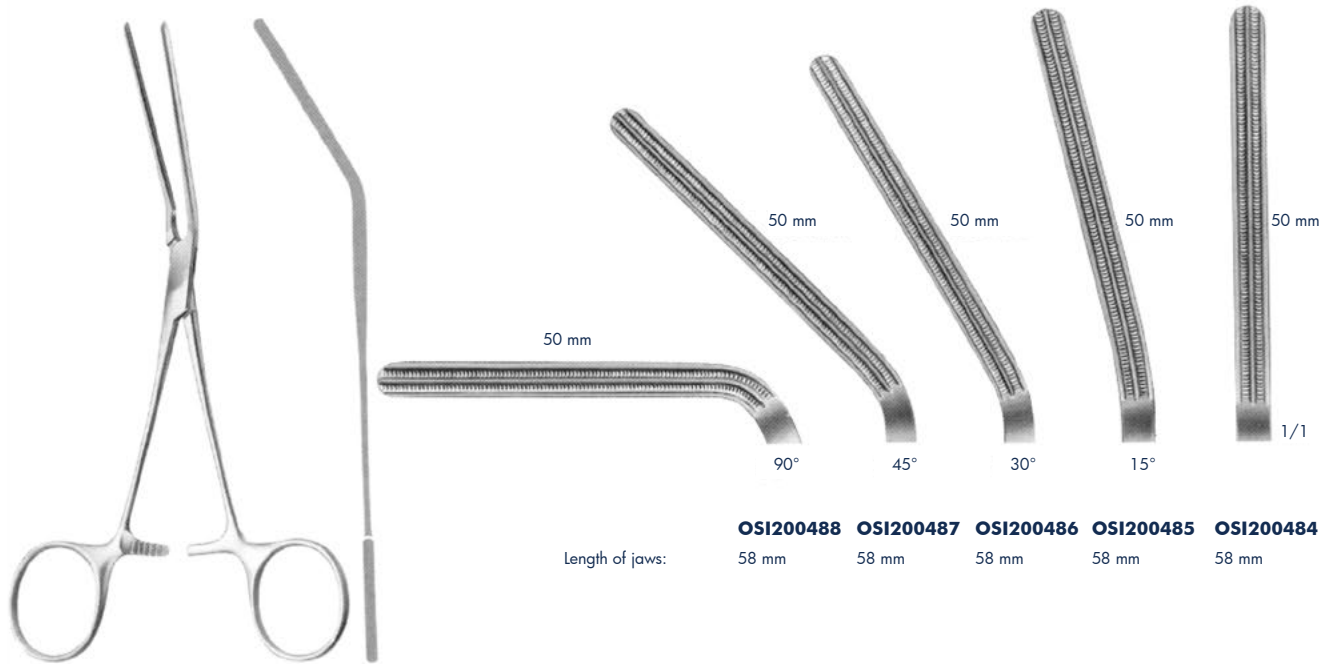

Length of jaws: **OSI200488** 58 mm **OSI200487** 58 mm **OSI200486** 58 mm **OSI200485** 58 mm **OSI200484** 58 mm

- OSI200479** 150 mm
- OSI200480** 150 mm
- OSI200481** 150 mm
- OSI200482** 145 mm
- OSI200483** 130 mm

- OSI200484** 170 mm
- OSI200485** 170 mm
- OSI200486** 170 mm
- OSI200487** 160 mm
- OSI200488** 135 mm

Vessel Clamps with silicone mouth inserts

ATRAUMATIC



MÜLLER
OSI200489
165 mm



OSI200490

Silicone mouth inserts for OSI200489
Sales unit : DZ = Package of 12 pieces

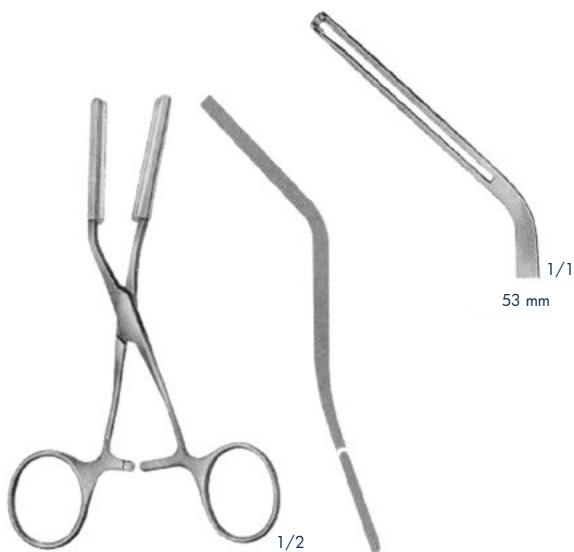

MÜLLER
OSI200491
angled 45°
125 mm

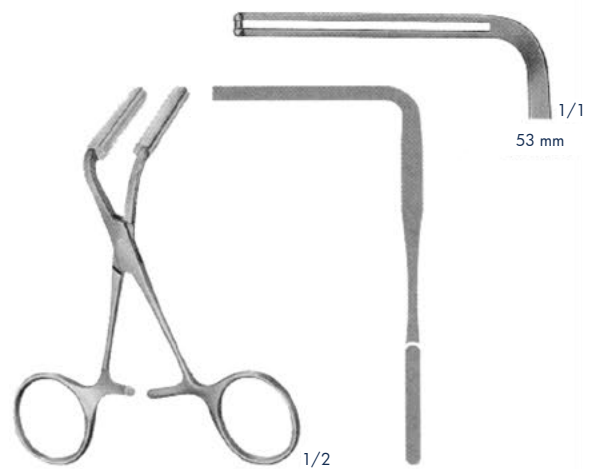

MÜLLER
OSI200492
angled 90°
105 mm

Vessel Clamps with silicone mouth inserts

ATRAUMATIC

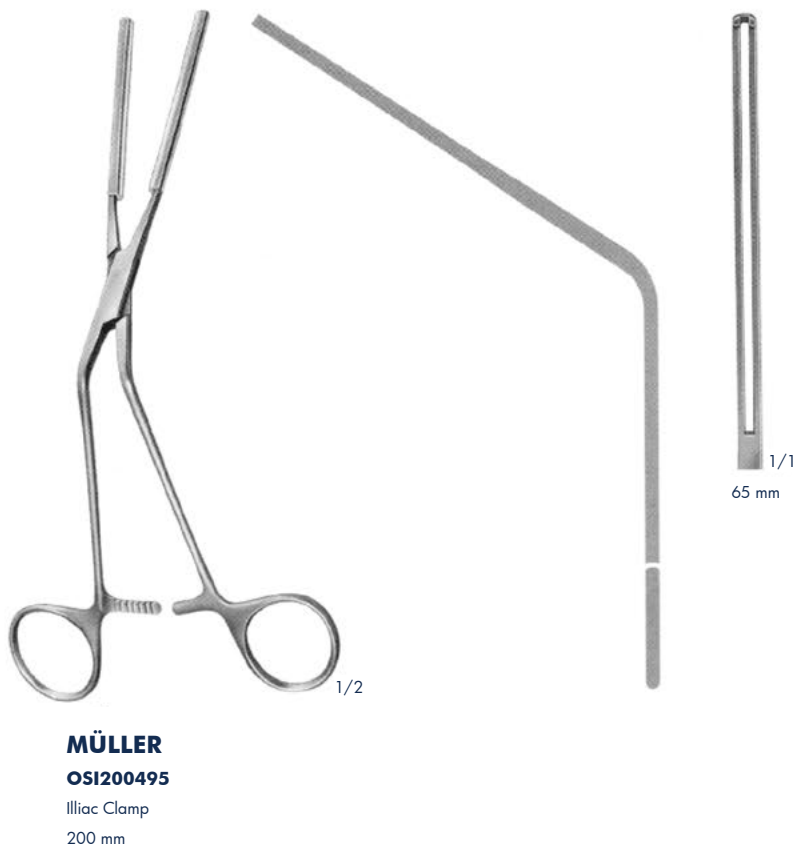

Vessel Clamps with silicone mouth inserts

ATRAUMATIC



MÜLLER
OS1200496
300 mm

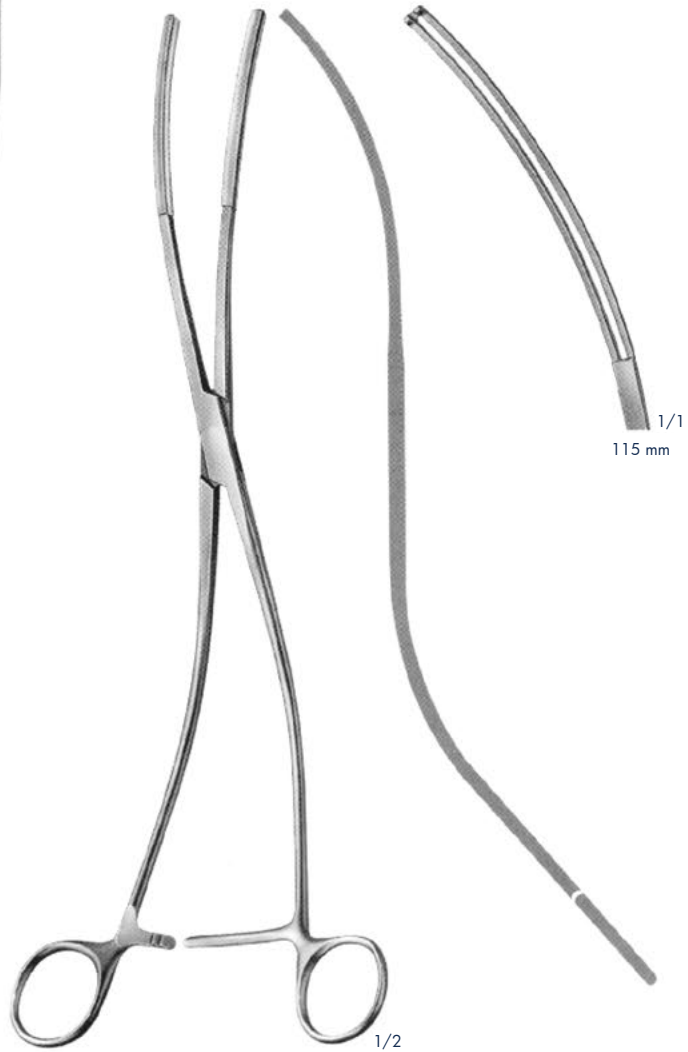
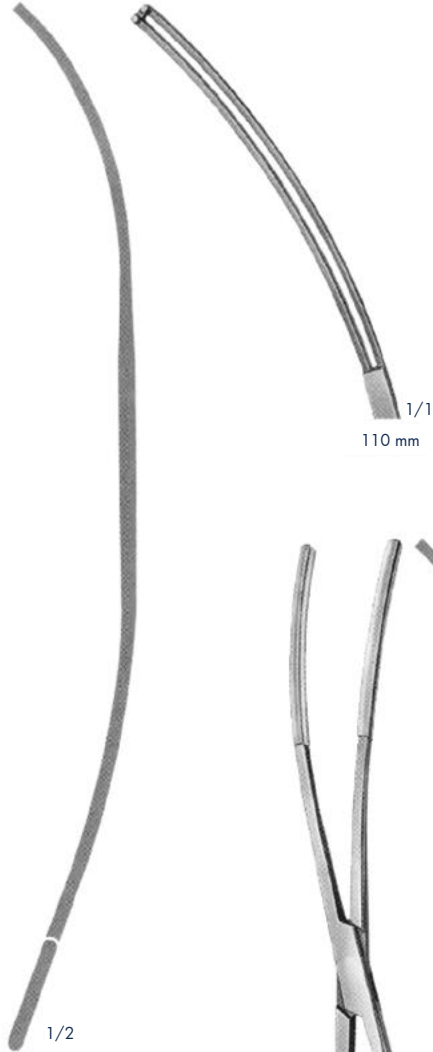

MÜLLER
OS1200497
300 mm



Vessel Clamps with silicone mouth inserts

ATRAUMATIC



Tissue-and Organ Grasping Forceps

ATRAUMATIC

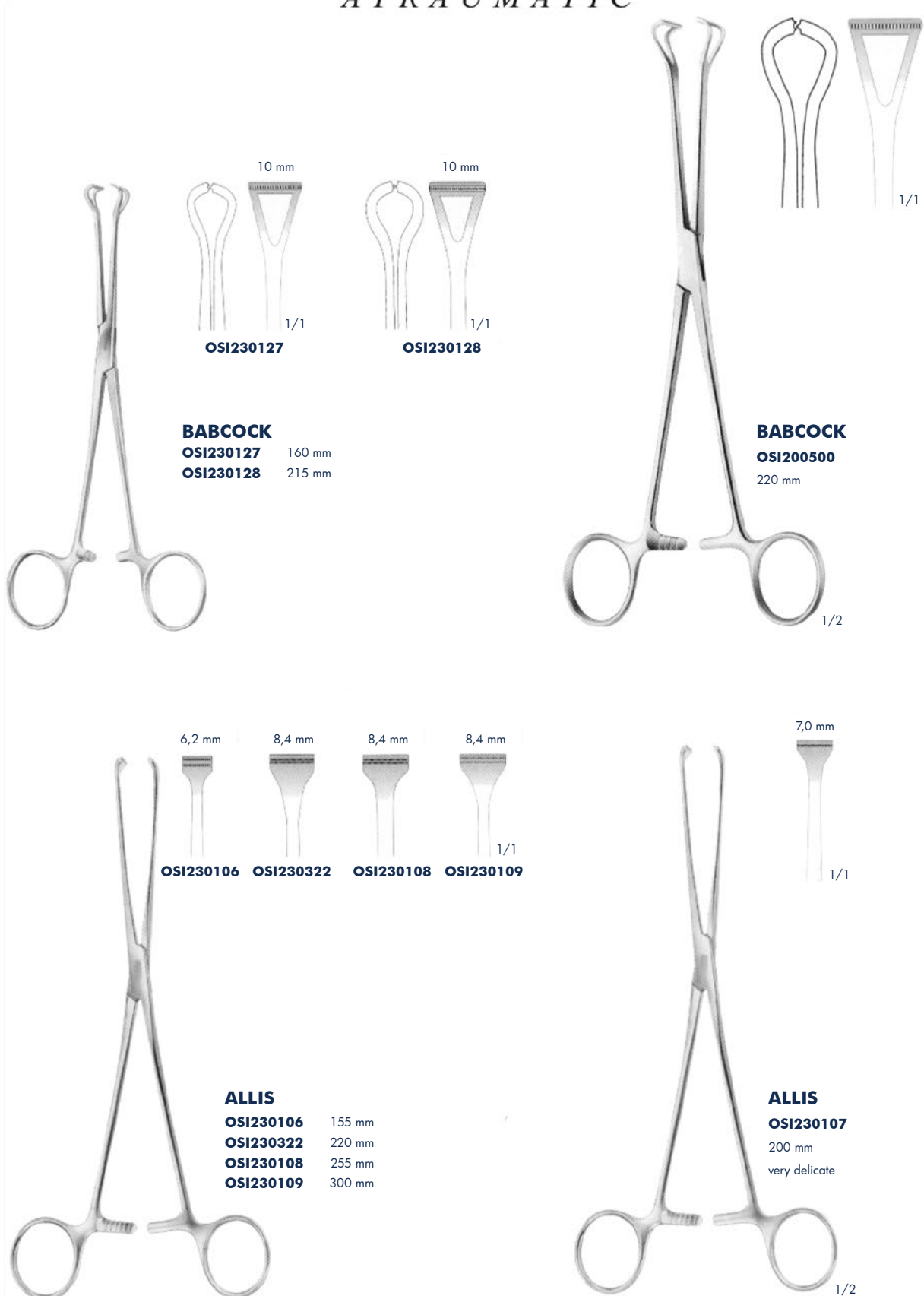

Tissue-and Organ Grasping Forceps

ATRAUMATIC



OS1130127 250 mm
OS1130128 270 mm

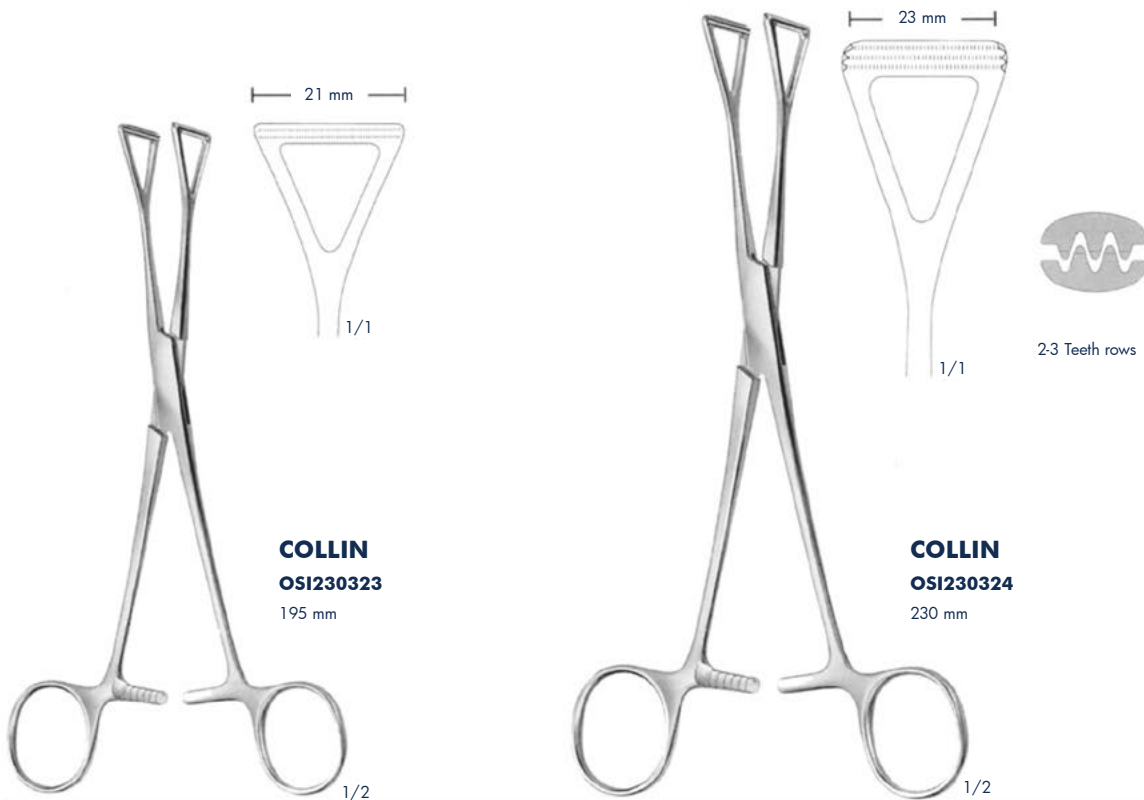

COLLIN
OS1230323
 195 mm

COLLIN
OS1230324
 230 mm



2-3 Teeth rows

Lung Grasping Forceps



WILLIAMS
OSI230119
 160 mm

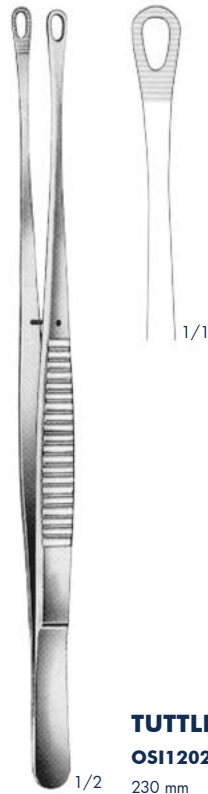

TUTTLE
OSI120211
 230 mm

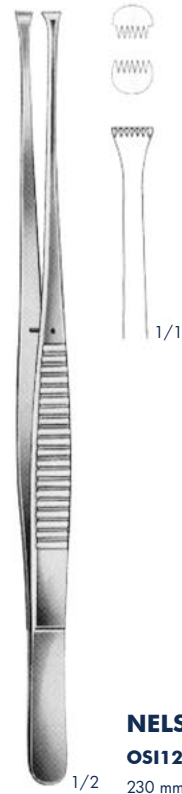

NELSON
OSI120212
 230 mm



DUVAL
OSI200501
 230 mm



BABCOCK
OSI230124 170 mm
OSI230125 215 mm
OSI200502 220 mm



ALLIS
OSI230116
 220 mm

Dissecting- and Ligature Forceps



FINOCHIETTO
OSI130513

245 mm

1/2

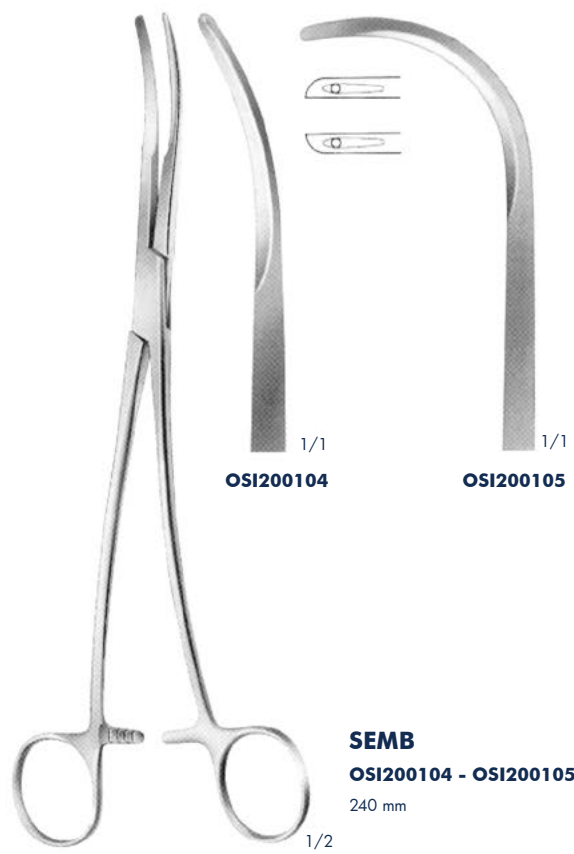

SEMB

OSI200104 - OSI200105

240 mm

1/2



Fixation Clamp

Forceps for efficient tissue gluing in aortic dissection.



BORST
OSI200503
215 mm

Vascular Clamps

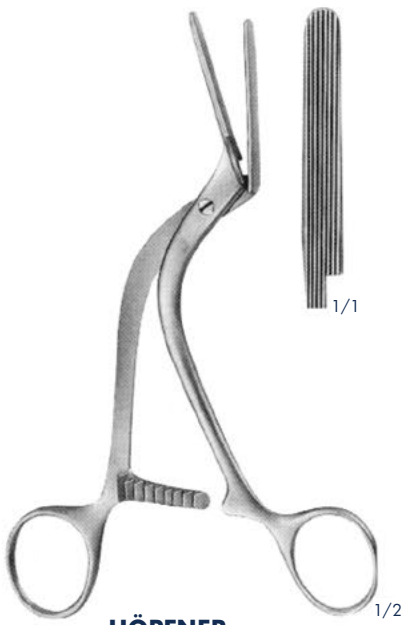

HÖPFNER
OSI200504
 Vascular clamp
 160 mm



SATINSKY
OSI200506
 Anastomosis clamp
 265 mm

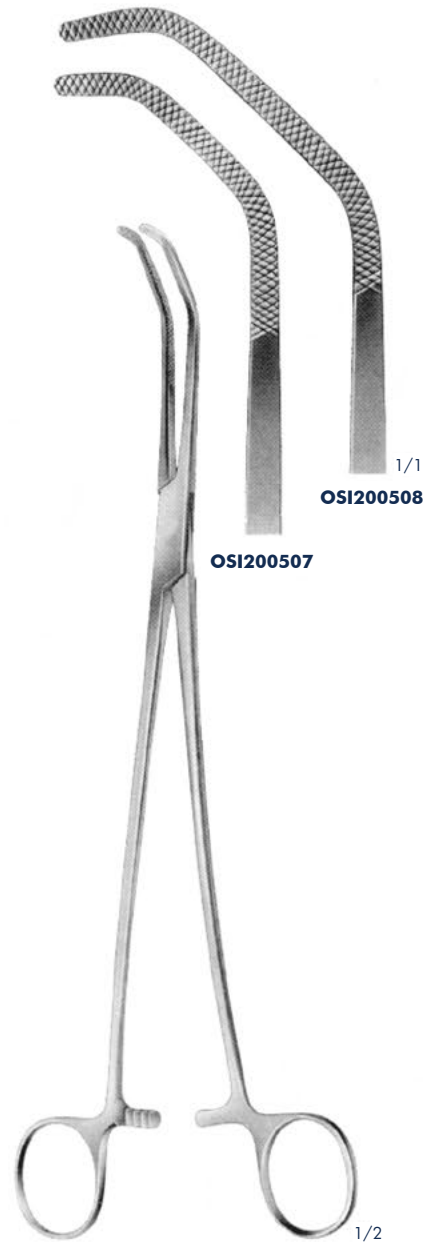

SATINSKY
OSI200507 - OSI200508
 Anastomosis clamps
 265 mm



BABY-SATINSKY
OSI200505
 Anastomosis clamp
 150 mm

Vascular Clamps

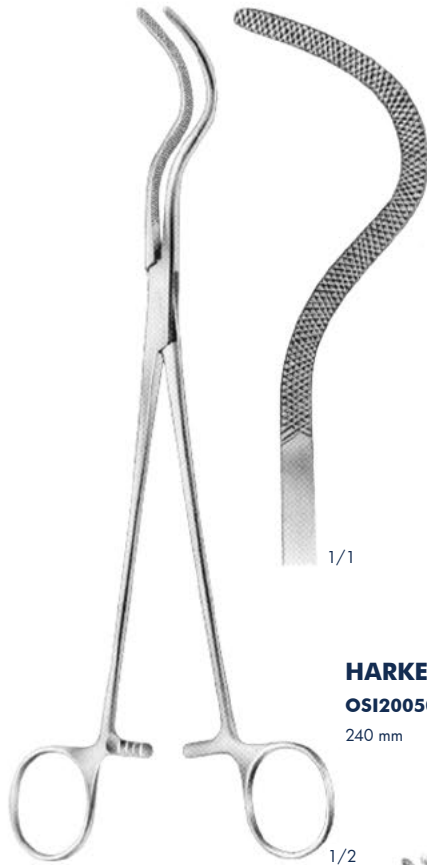

HARKEN
OSI200509
240 mm



HARKEN
OSI200510
240 mm

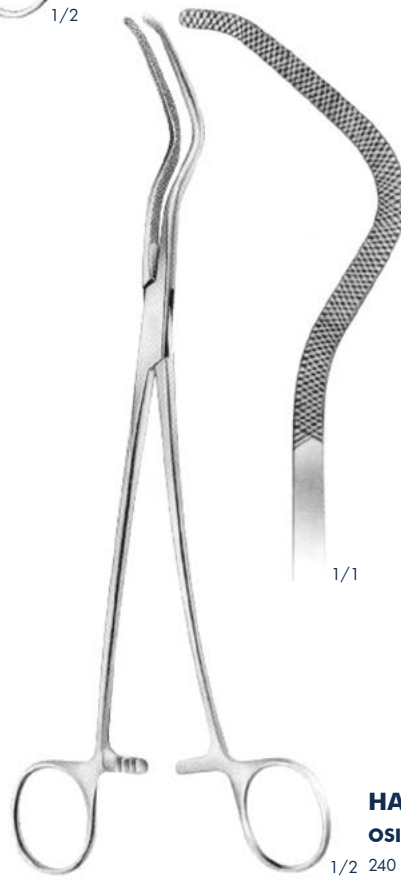

HARKEN
OSI200512
240 mm

Carotid Clamp, Vascular Clamps



PERTUISET
OSI200513
Carotid Clamp
90 mm



CRAFOORD-SELLORS
OSI200514
240 mm



CRAFOORD
OSI200515 - OSI200516
240 mm

Bronchus Forceps

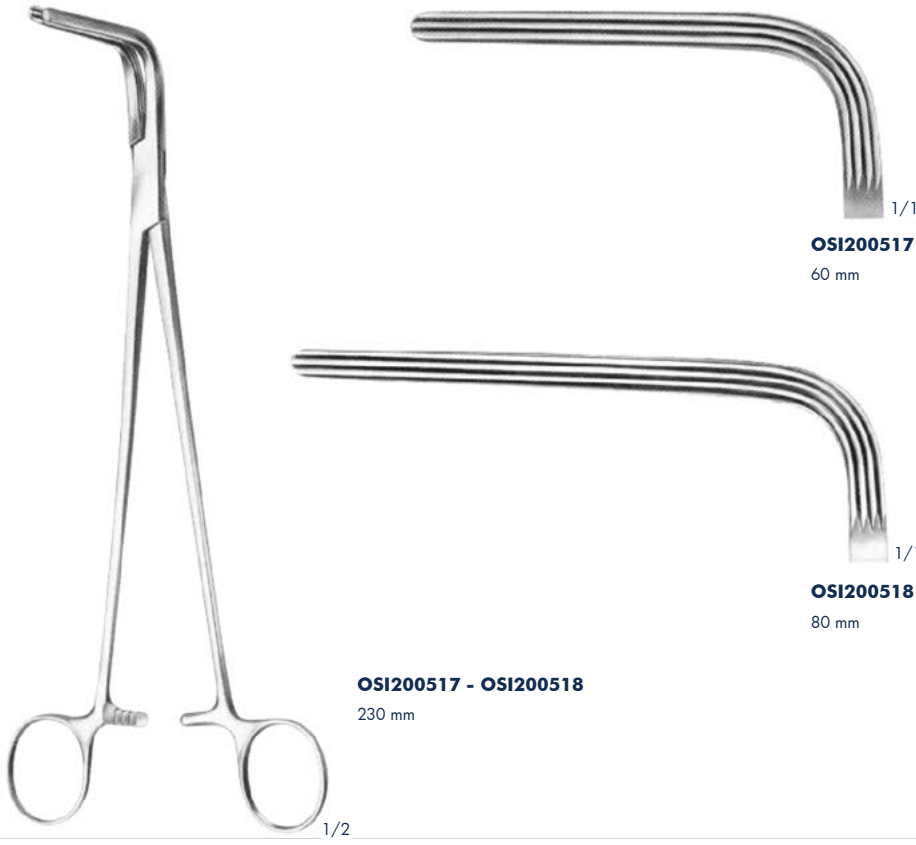

Sternum Instruments



WITT
OSI200519 1,5 x 35 mm
OSI200520 1,5 x 51 mm
Sternal puncture needle
with Luer cone



SCHUMACHER
OSI200521
Sternum shears
210 mm

Sternum Instruments



BRAUN-STADLER
OSI110322

Sternum shears for children
200 mm



LEBSCHE
OSI200522

Sternum chisel
200 mm

Rib Shears



OSI190615
230 mm



COLLIN
OSI200523
195 mm



GLUCK
OSI200524
190 mm



BETHUNE
OSI200525
340 mm

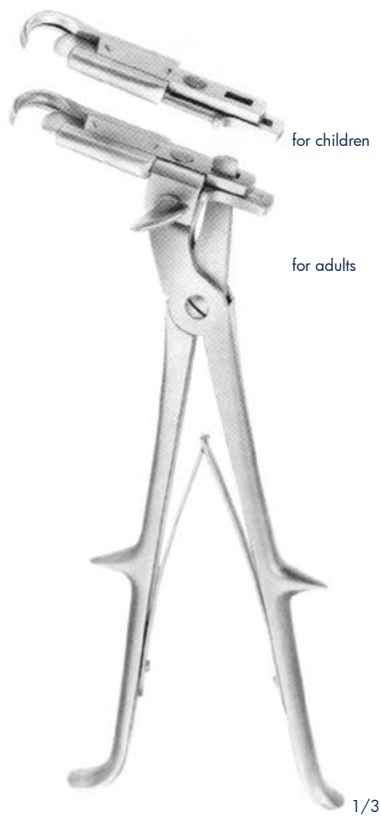

SAUERBRUCH-BRITSCH
OSI200526
with 2 exchangeable
cutterheads
300 mm



SAUERBRUCH
OSI190616 **OSI200527**
for children for adults
240 mm 270 mm

Rib Shears



SAUERBRUCH-FREY

OSI200528

for the first rib
370 mm



BRUNNER

OSI200529

Universal pattern
340 mm



GIERTZ-STILLE

OSI190617

250 mm

Rib Holding Forceps, Bone Cutting Forceps



1/3

SEMB

OSI190507

Rib and bone holding forceps

190 mm



1/3

SEMB

OSI190815

Rib and bone holding forceps

190 mm

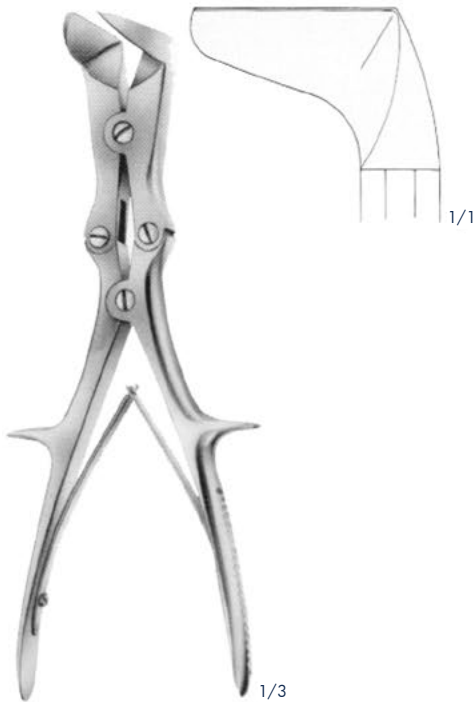

1/3

1/1

LISTON-STILLE

OSI190608

265 mm



1/3

1/1

**LISTON-KEY-HORSLEY
(TUDOR EDWARDS)**

OSI190612

255 mm

S-shaped for posterior rib ends

Rib Rongeurs

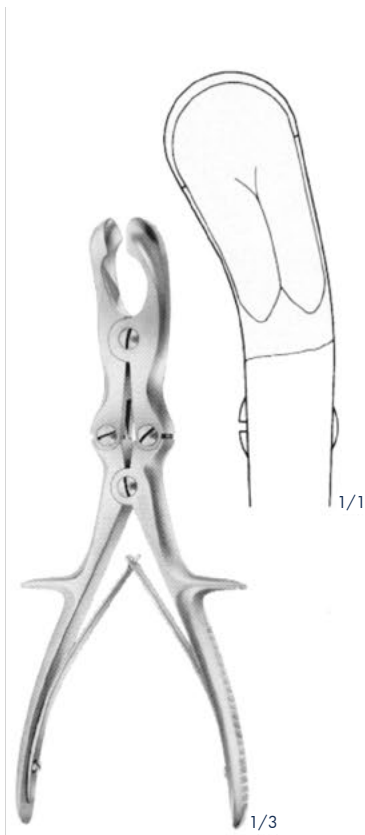

SEMB
OSI190571
 Rib rongeur to shorten
 the rib stumps
 240 mm



SAUERBRUCH-CORYLLOS
OSI190586 - OSI190587
 Rib rongeur to shorten
 the rib stumps
 310 mm

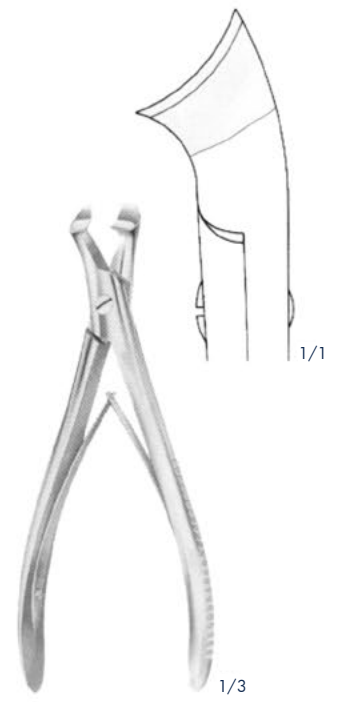

MARKWALDER
OSI190588
 Rib rongeur to round
 the rib stumps
 190 mm

Rib Raspatories



OSI190431



OSI190432



DOYEN
OSI190431 - OSI190432
for children
175 mm

1/2



OSI190736



OSI190737



DOYEN
OSI190736 - OSI190737
240 mm

1/2



OSI190433



OSI190434



DOYEN
OSI190433 - OSI190434
for adults
175 mm

1/2

Rib Raspatories



SEMB
OSI190439
OSI190443



OSI190439
12 mm
190 mm



OSI190440
12 mm
230 mm

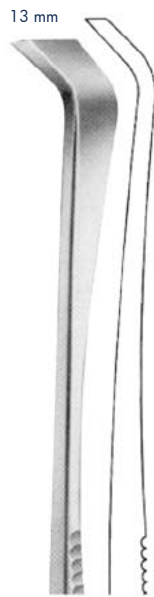

OSI190441
13 mm
230 mm

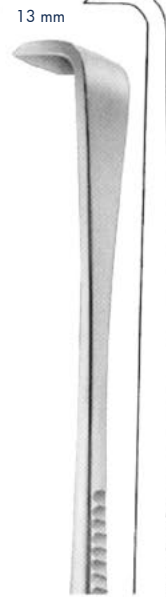

OSI190442
13 mm
230 mm

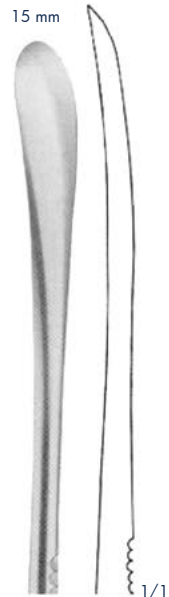

OSI190443
15 mm
230 mm



LANGENBECK
OSI190414
190 mm

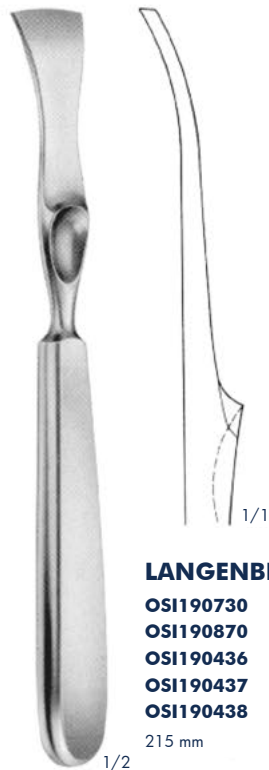

LANGENBECK
OSI190730 5 mm
OSI190870 10 mm
OSI190436 15 mm
OSI190437 20 mm
OSI190438 25 mm
215 mm

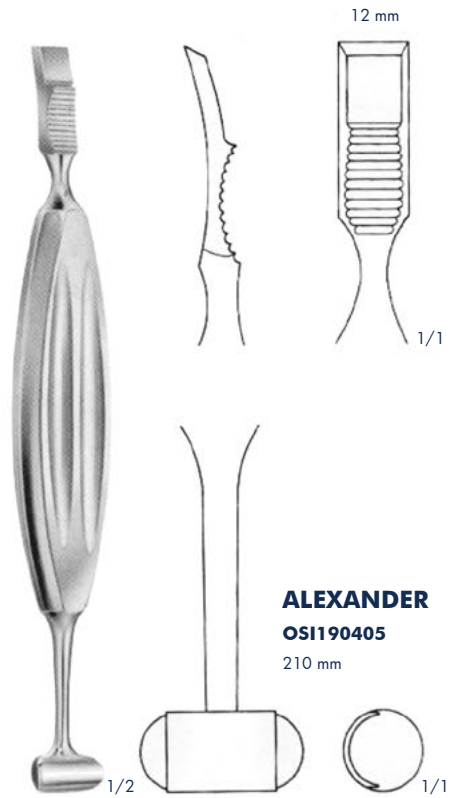

ALEXANDER
OSI190405
210 mm

FINOCHIETTO Thoracic Retractors (Aluminium)

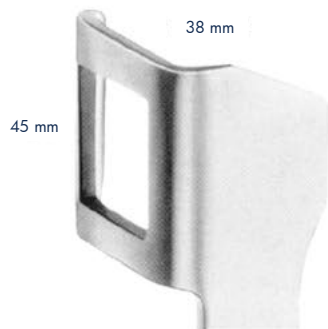

Sizes of rib spreader blades are indicated as follows:
 1st number = depth Example: 38 x 45 mm
 2nd number = width

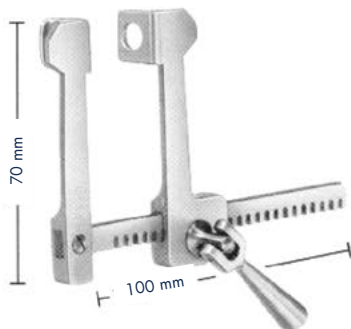

FINOCHIETTO
OSI190621
 12 x 15 mm

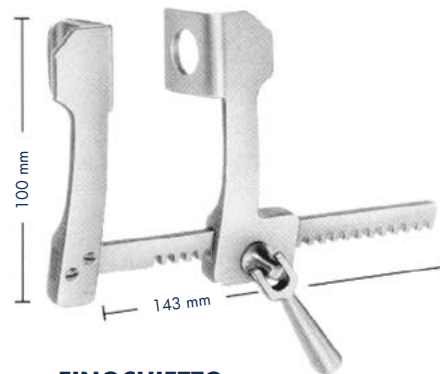

FINOCHIETTO
OSI190622
 28 x 30 mm

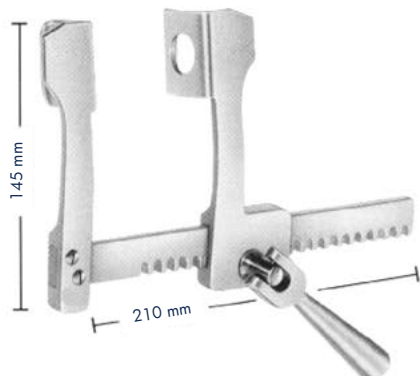

FINOCHIETTO
OSI200530
 31 x 45 mm

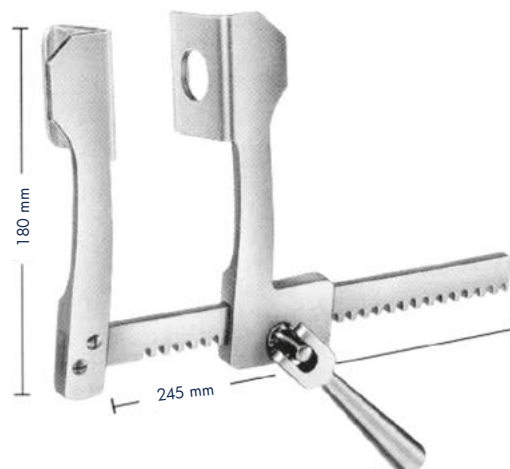

FINOCHIETTO
OSI200531
 42 x 61 mm

FINOCHIETTO Thoracic Retractors (Aluminium) Rib Retractors for Infants

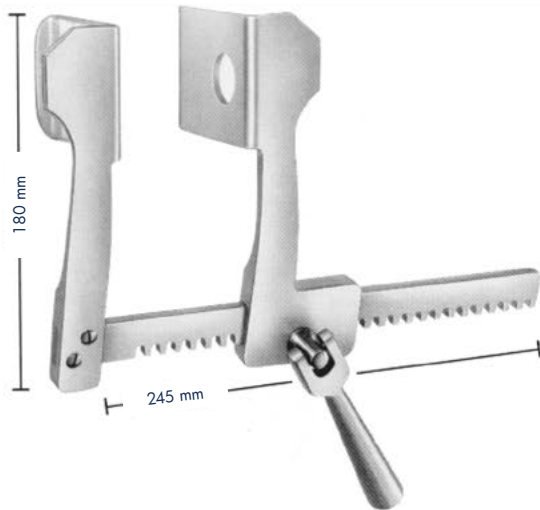

FINOCHIETTO

OSI200532

Blades
74 x 64 mm

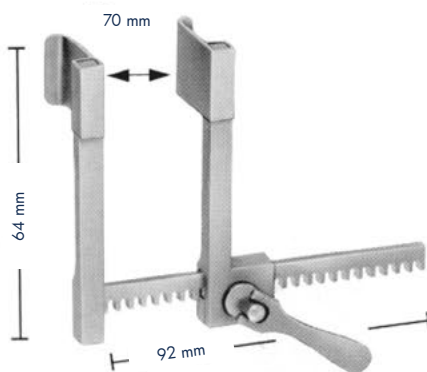

STRUCK

OSI200533

for infants
consisting of:

OSI200602 Retractor only

OSI200537 Blades, 1 pair

OSI200538 Blades, 1 pair

OSI200534

Blades
10 x 10 mm

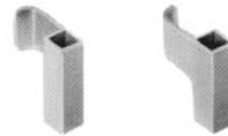

OSI200535

Blades
10 x 15 mm



OSI200536

Blades
10 x 20 mm



OSI200537

Blades
15 x 20 mm



OSI200538

Blades
20 x 20 mm



Rib Spreaders for Children

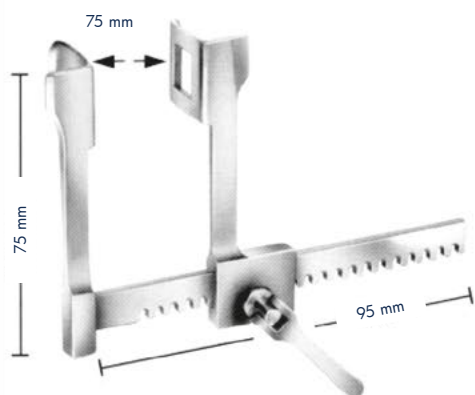

FINOCHIETTO

OSI200539

Blades

18 x 21 mm

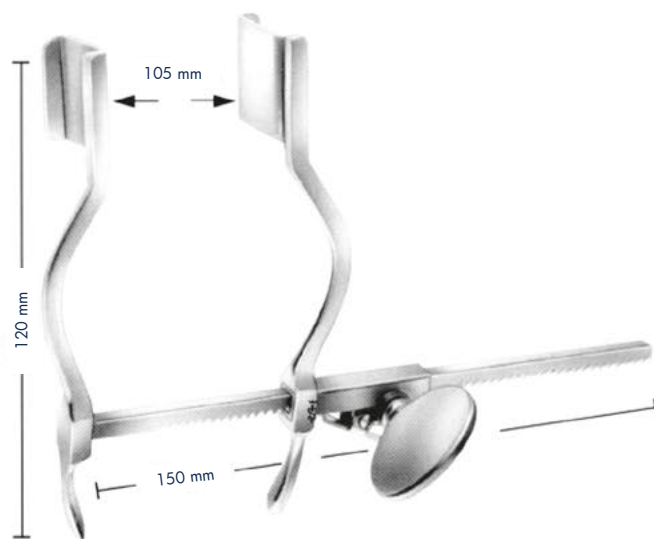

HERTZLER

OSI150909

Blades

20 x 25 mm

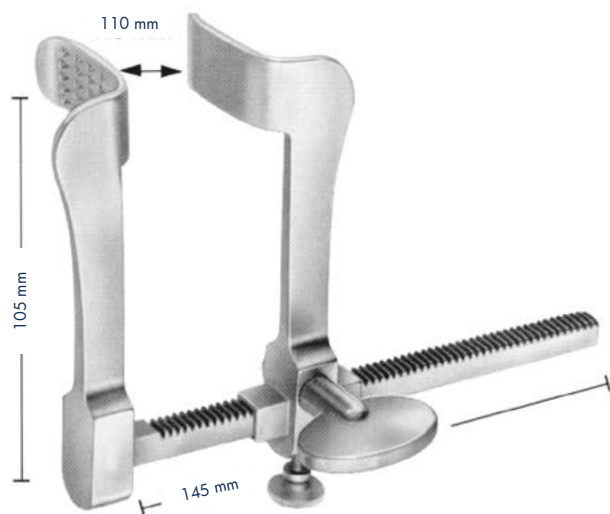

TUFFIER

OSI200540

Blades

32 x 19 mm

Rib Spreaders

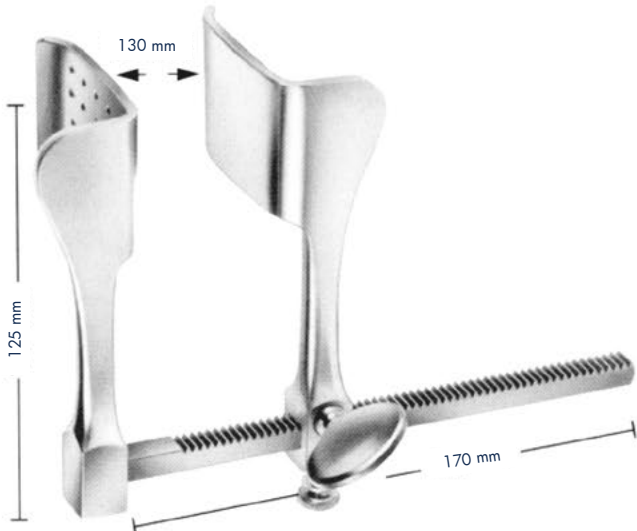

TUFFIER
OSI200541
 Blades
 43 x 53 mm

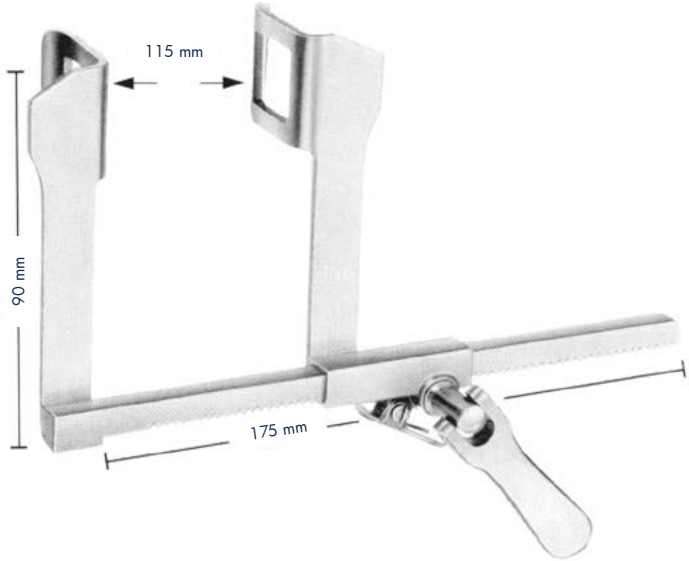

HAIGHT
OSI190634
 Blades
 30 x 30 mm

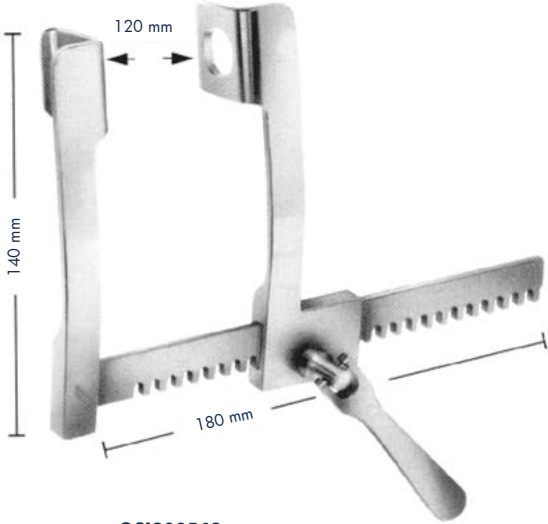

OSI200542
 Blades
 28 x 32 mm

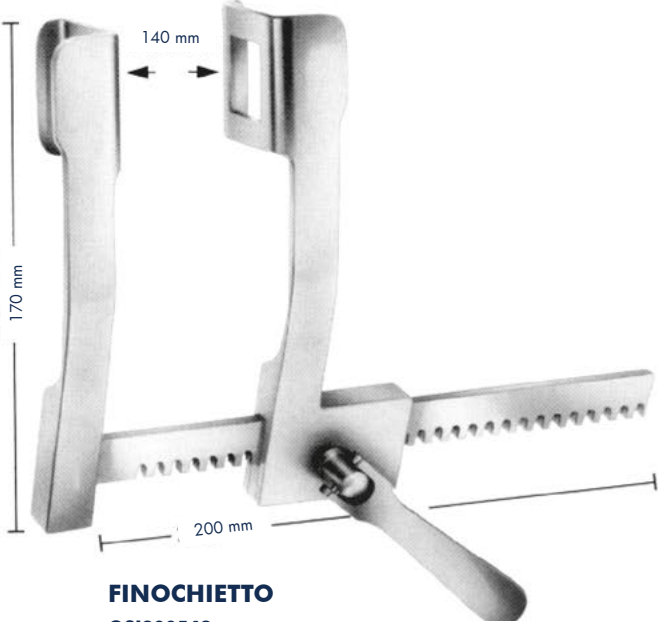

FINOCHIETTO
OSI200543
 Blades
 36 x 45 mm

Rib Spreaders

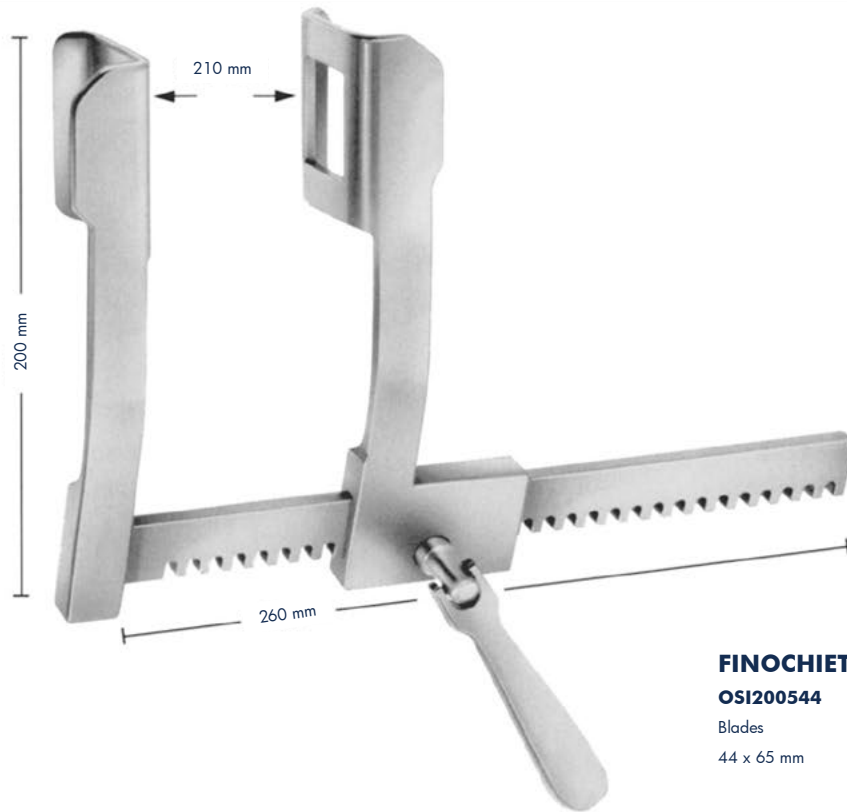

FINOCHIETTO
OSI200544

Blades
44 x 65 mm

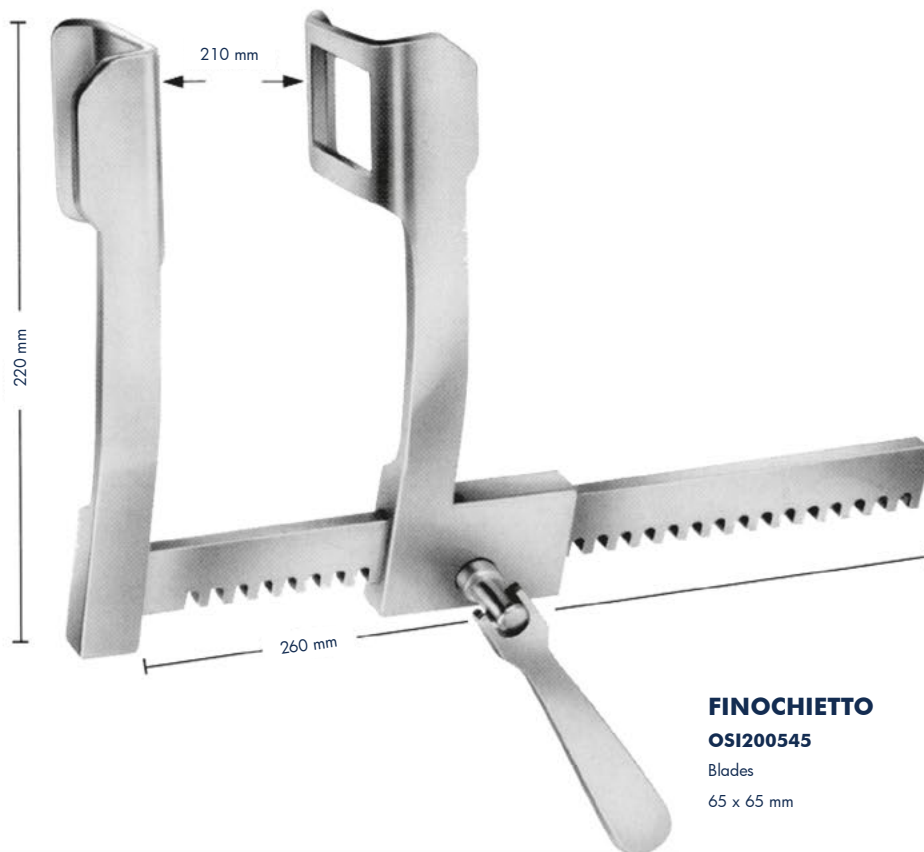

FINOCHIETTO
OSI200545

Blades
65 x 65 mm

Rib Spreaders

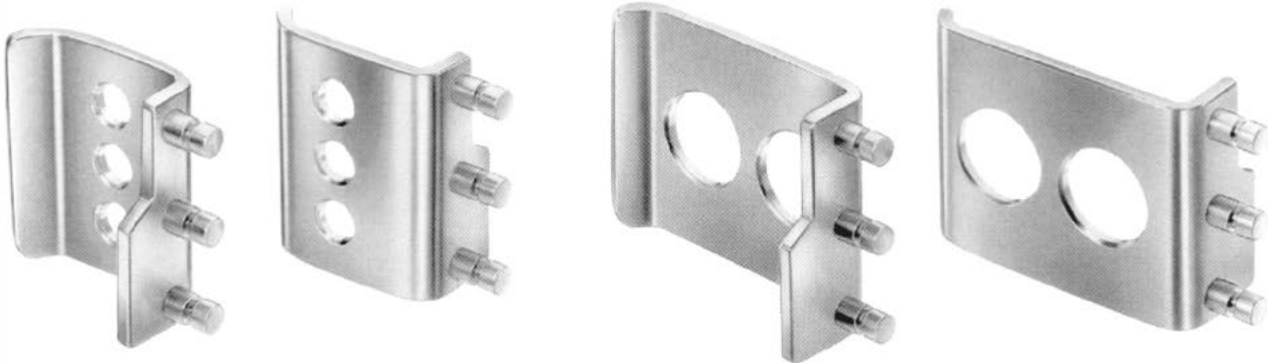

OSI200547
Blades
40 x 67 mm

OSI200548
Blades
80 x 67 mm

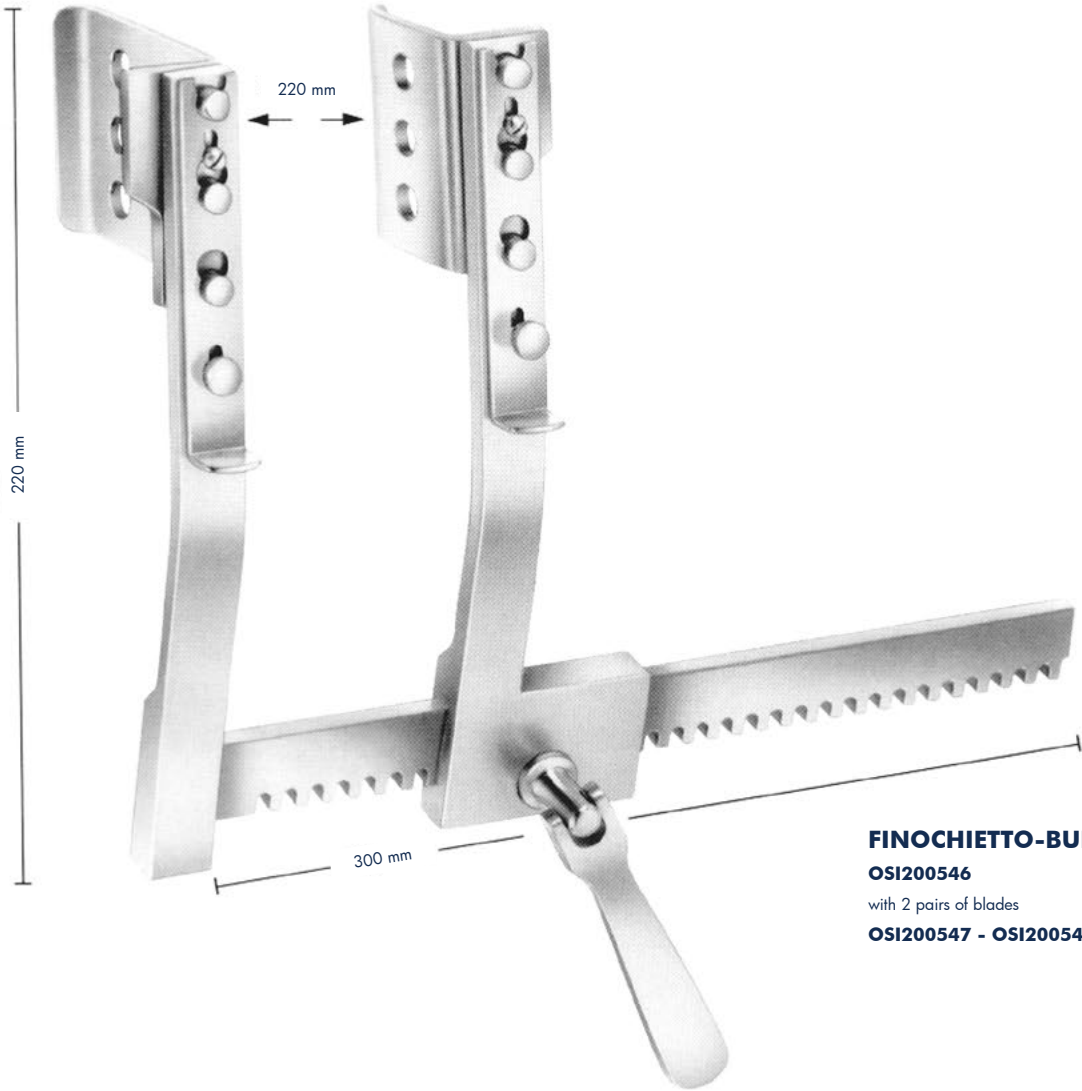

FINOCHIETTO-BURFORD
OSI200546
with 2 pairs of blades
OSI200547 - OSI200548

Rib Spreaders

DE BAKEY

OSI200604

with 3 pairs of blades

Components for OSI200604	
Spreader only	Blades only
OSI200605	OSI200549 30 x 30 mm
	OSI200550 40 x 40 mm
	OSI200551 50 x 50 mm

The blades are delivered in pairs.

Special advantages:
Improved fixing system for interchangeable blades.
No protruding parts, therefore no risk of catching sutures.

OSI200549

Blades
30 x 30 mm



OSI200550

Blades
40 x 40 mm



OSI200551

Blades
50 x 50 mm

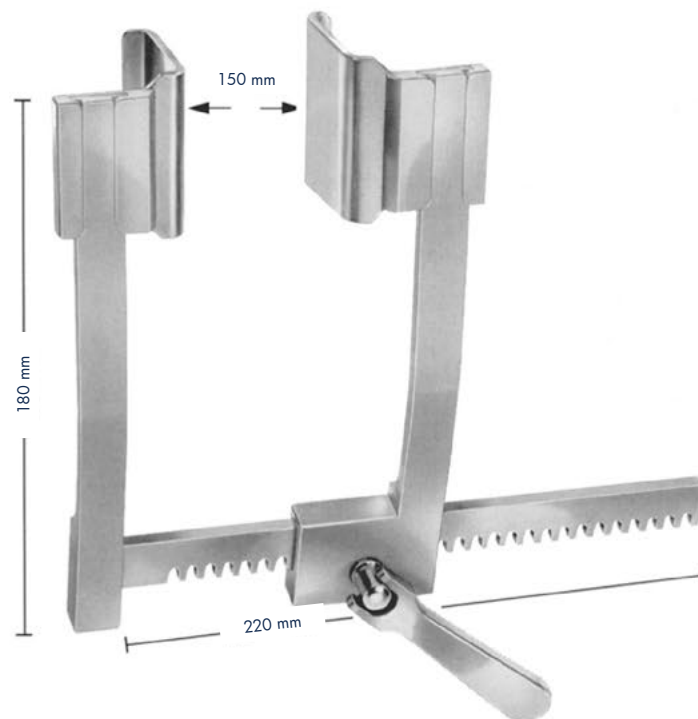

Rib Spreaders

DE BAKEY

OSI200552
with 3 pairs of blades

Components for OSI200552	
Spreader only	Blades only
OSI200553	OSI200554 60 x 60 mm
	OSI200555 50 x 80 mm
	OSI200556 40 x 100 mm

The blades are delivered in pairs.

Special advantages:
Improved fixing system for interchangeable blades.
No protruding parts, therefore no risk of catching sutures.

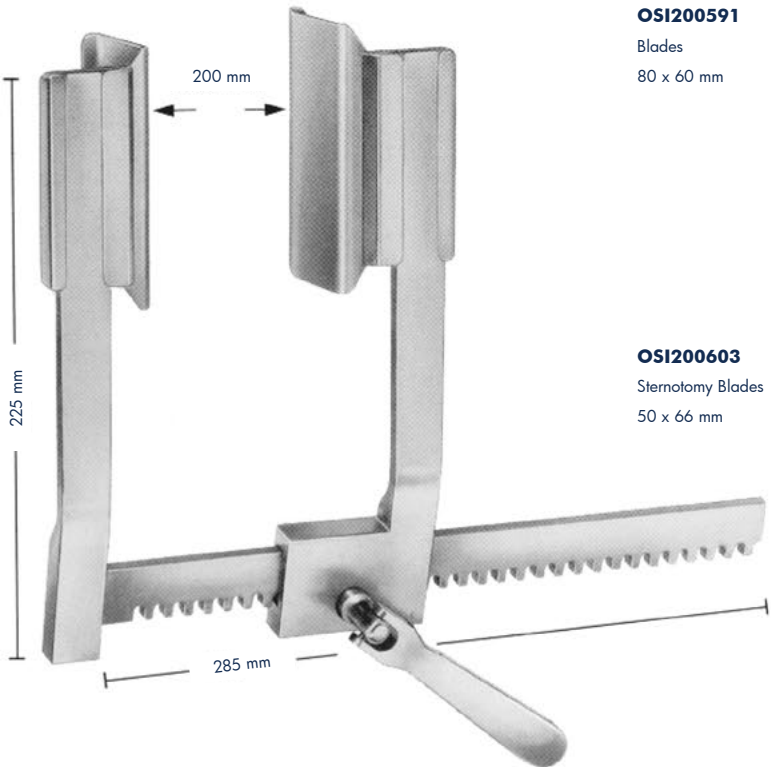

OSI200554
Blades
60 x 60 mm

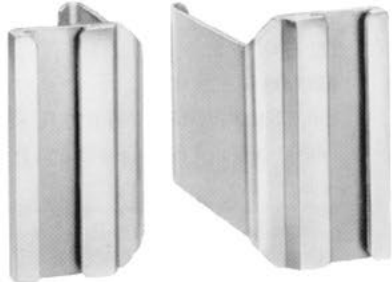

OSI200555
Blades
50 x 80 mm



OSI200556
Blades
40 x 100 mm

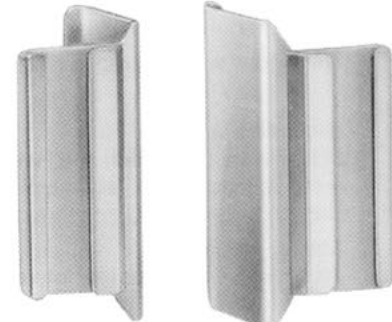

OSI200591
Blades
80 x 60 mm

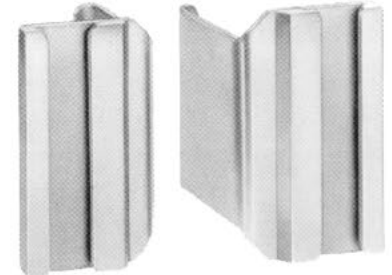

OSI200603
Sternotomy Blades
50 x 66 mm



Sternum Spreaders

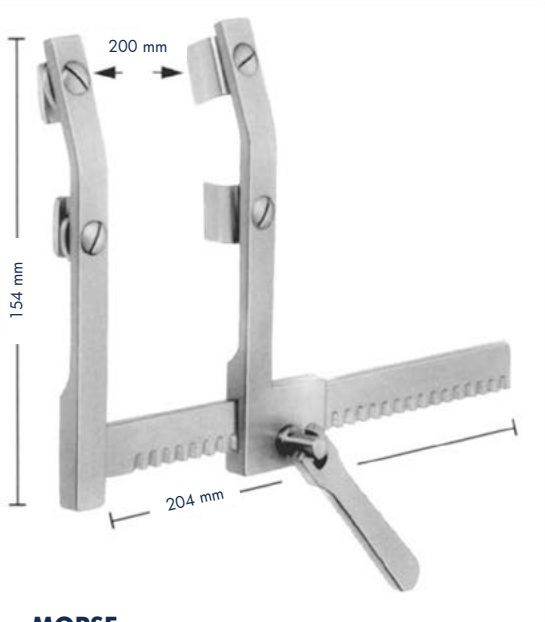

MORSE
OSI200557

Sternum spreader for children with movable double blades, each blade 12 x 20 mm

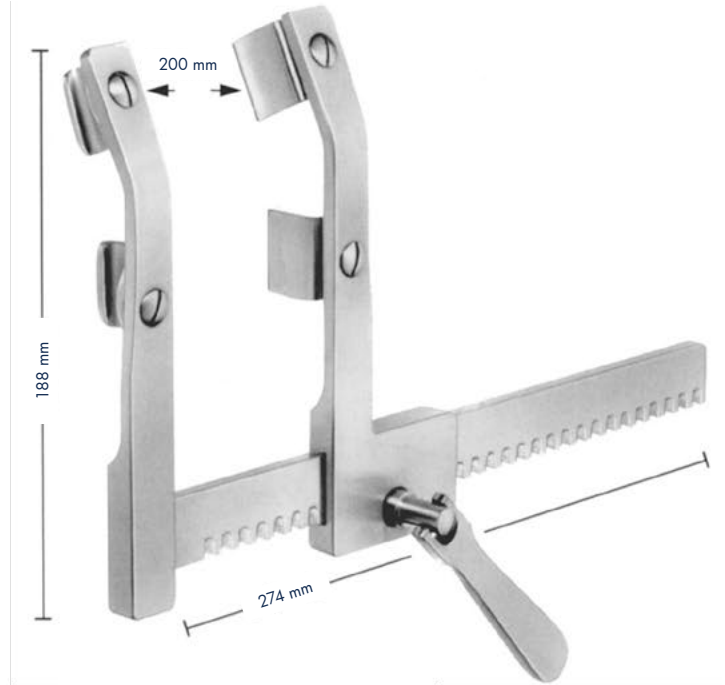

MORSE
OSI200558

Sternum spreader for adults with movable double blades, each blade 19 x 29 mm

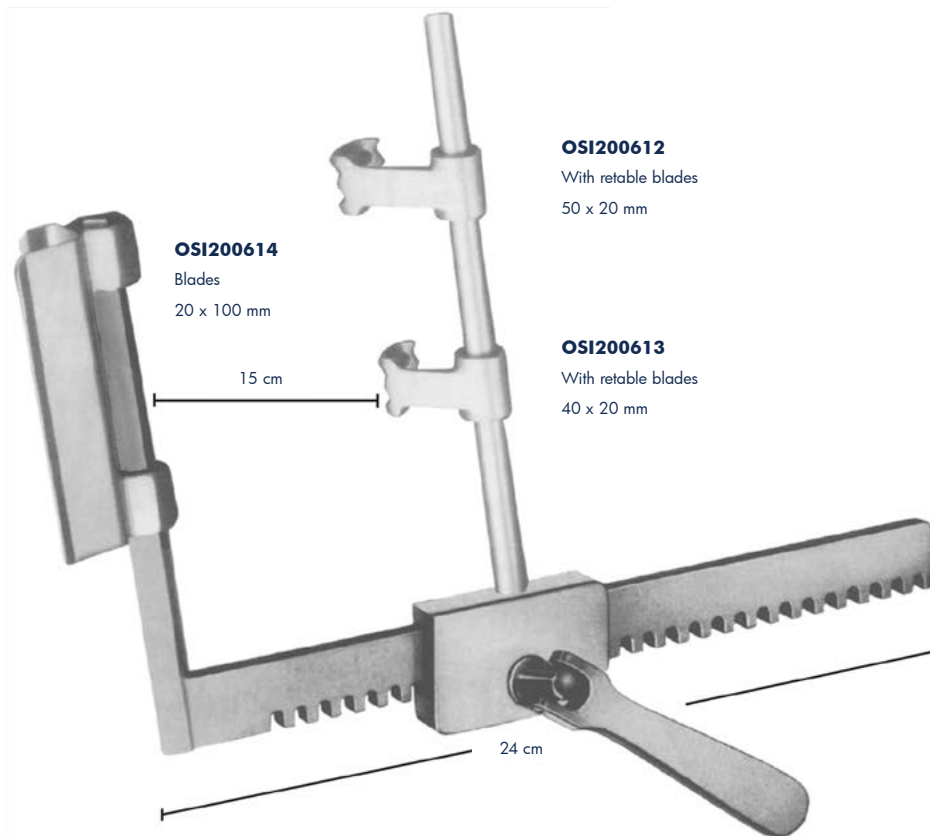

OSI200614
Blades
20 x 100 mm

OSI200612
With retractable blades
50 x 20 mm

OSI200613
With retractable blades
40 x 20 mm

OSI200611
Retractor only

OSI200610

- Rib Spreader complete
- OSI200611** Retractor only
- OSI200612** Blade (pair)
- OSI200613** Blade (pair)
- OSI200614** Blade (pair)

Sternum Spreaders

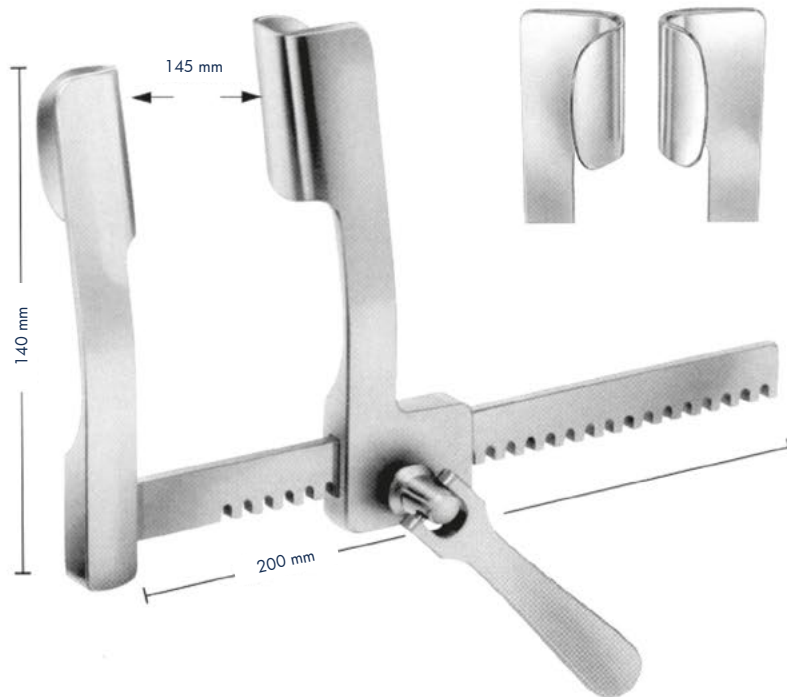

COOLEY
OSI200559

Blades
21 x 45 mm
for children

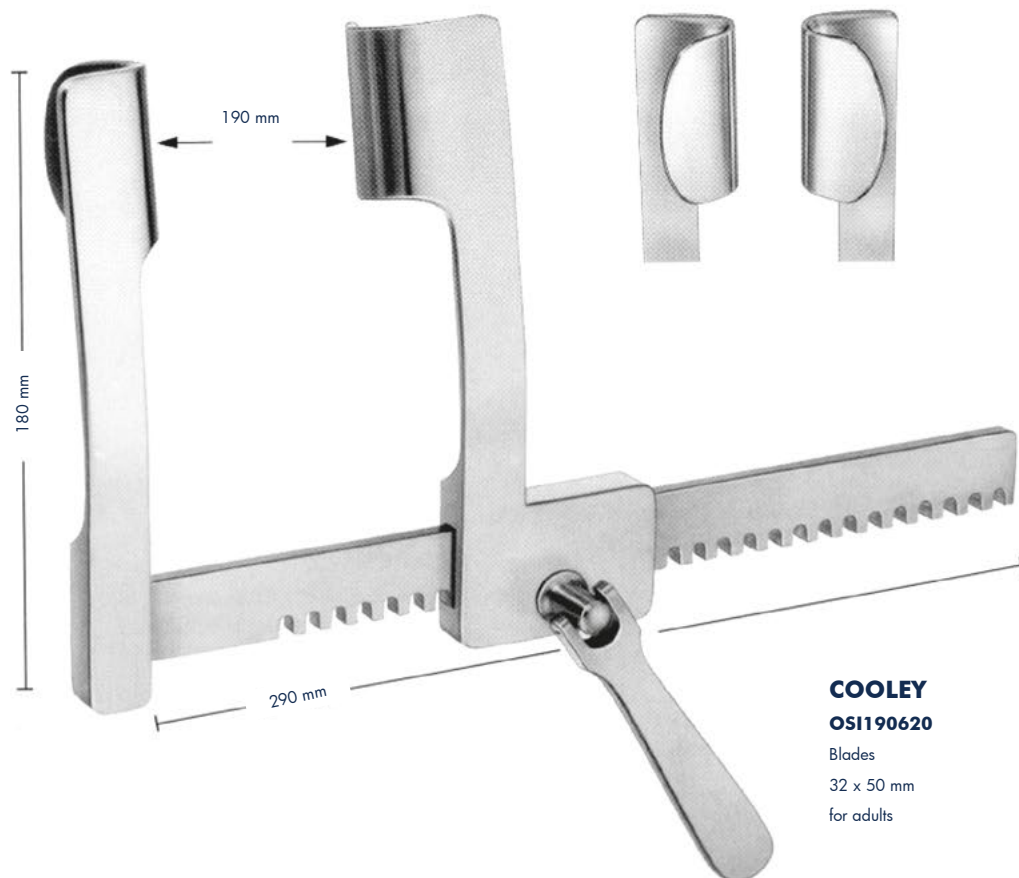

COOLEY
OSI190620

Blades
32 x 50 mm
for adults

Thoracic Retractor



OSI190869
Blades
75 x 75 mm



OSI190868
Blades
42 x 65 mm



Blades with Ball Snap System
Delivery: in pairs

- OSI190637**
Thoracic retractor (Mercedes-Retractor) complete
consisting of:
OSI190867 Retractor only
OSI190868 1 Pair of blades 42 x 65 mm
OSI190869 1 Pair of blades 75 x 75 mm

Sternum Spreaders

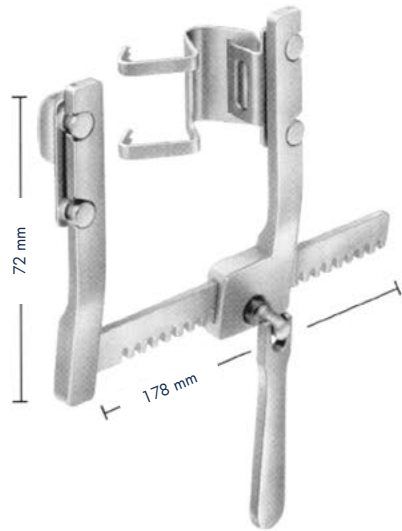

OSI200562



OSI200563

OSI200560

Mini Mammaria retractor, complete
consisting of:

OSI200561 Retractor only

OSI200562 Mammariablade complete

OSI200563 1 pair of sternum blades 30 x 50 mm

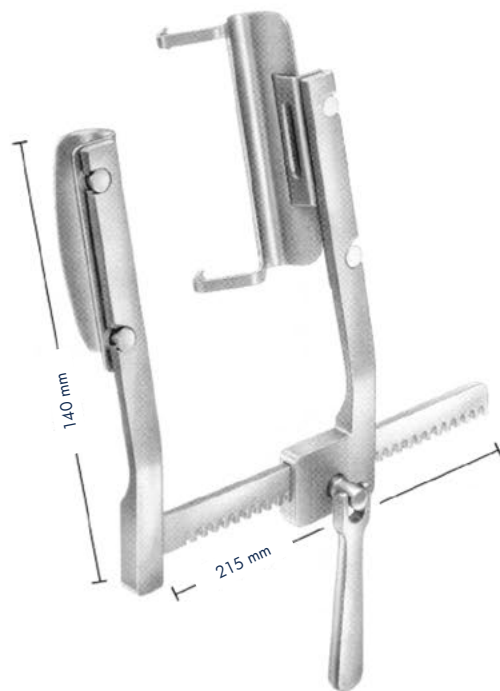

OSI200566

Mammariablade, complete



OSI200567
Sternum blades



OSI200568
Sternum blades

OSI200564

Mini Mammaria retractor, complete
consisting of:

OSI200565 Retractor only

OSI200566 Mammariablade complete

with holding blades left and right

OSI200567 1 pair of sternum blades 30 x 100 mm

OSI200568 1 pair of sternum blades 40 x 100 mm

Rib Spreaders- and Contractors



SELLORS
OS1190638
 Rib spreader and contractor
 with swivel blades
 200 mm



BAILEY
OS1190639
 150 mm



OS1190640
 for children



OS1190641
 for adults

BAILEY
OS1190640 - OS1190641
 200 mm

Retractors, Lung Spatulas

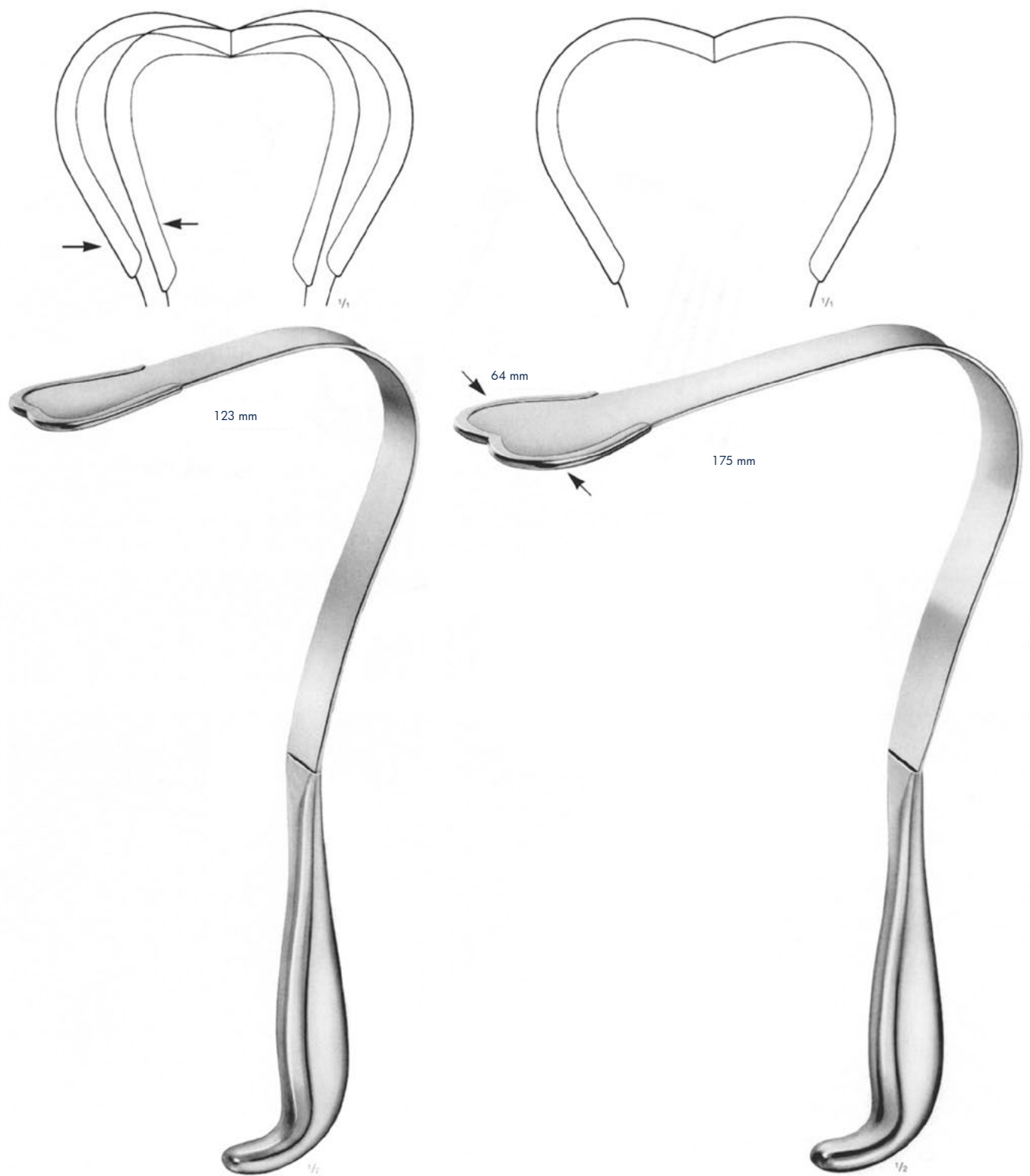

HARRINGTON
OSI150281 123 x 45 mm
OSI150282 123 x 64 mm
 flexible
 295 mm

HARRINGTON-PEMBERTON
OSI150675 175 x 64 mm
 flexible
 295 mm

Retractors, Lung Spatulas



Lung Spatulas

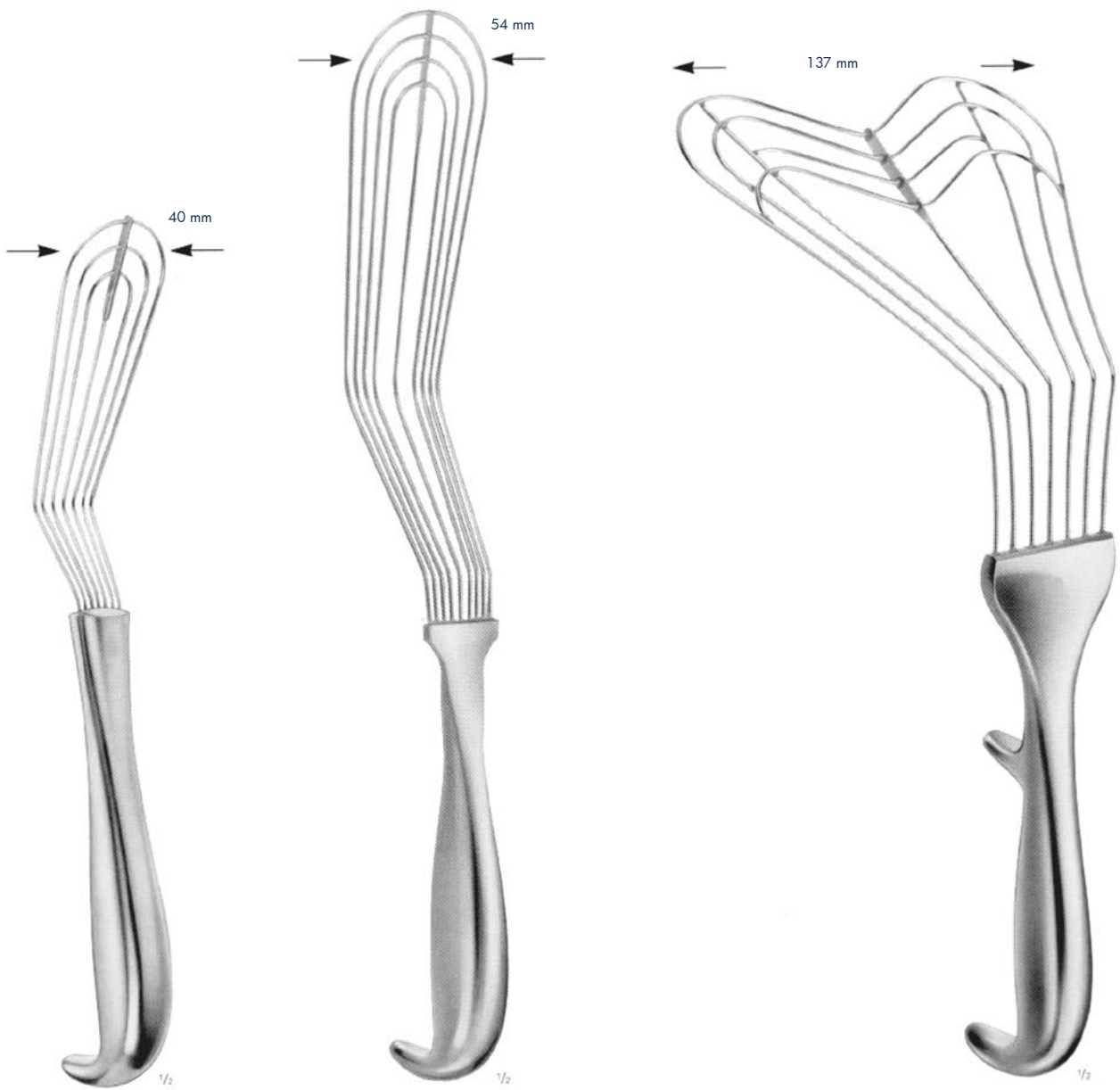

ALLISON
OSI190642
255 mm

ALLISON
OSI190643
320 mm

OSI190644
300 mm

Atrium Retractors

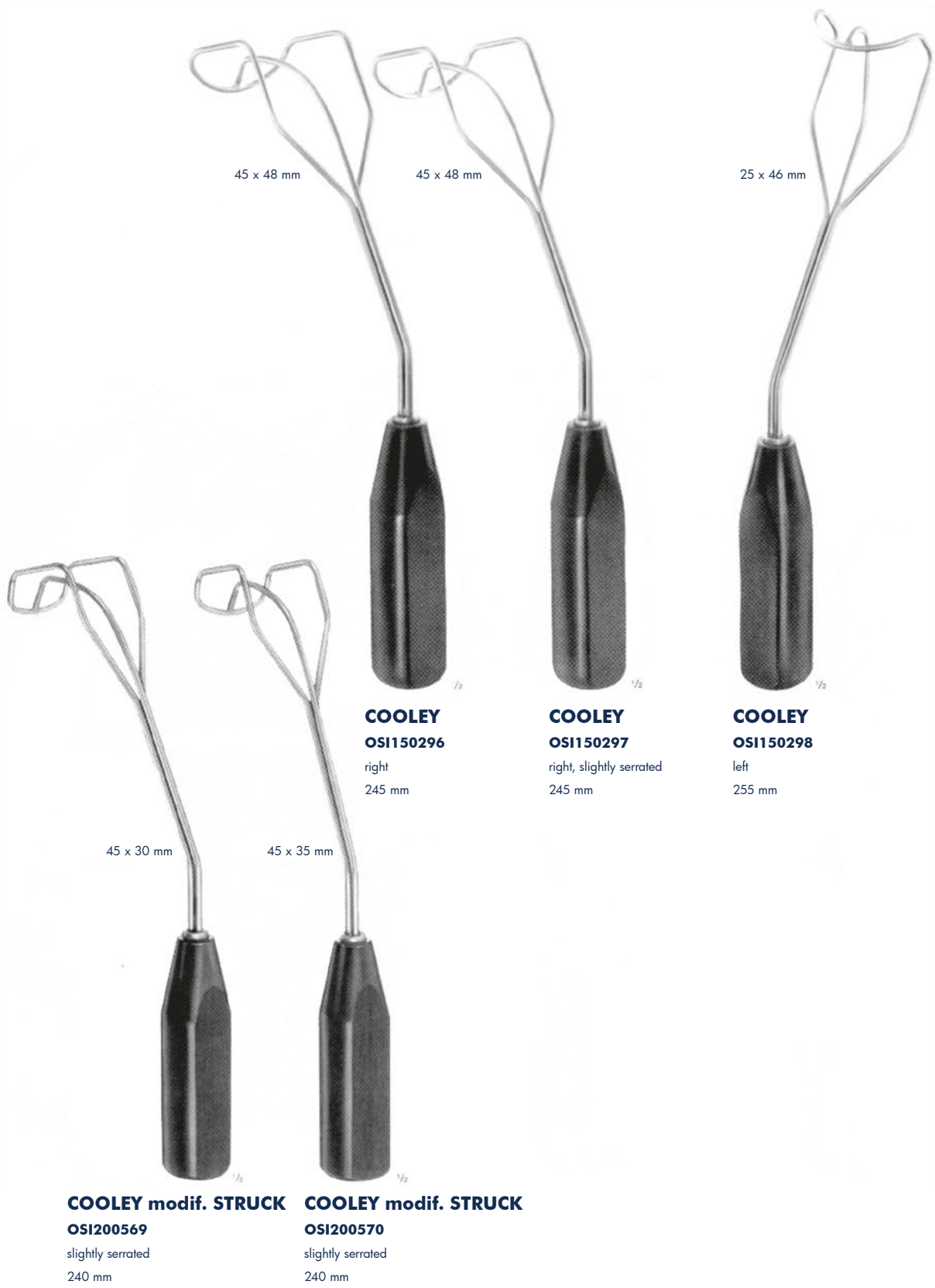

BOROWSKI Aorta Valve Retractors

Shaft malleable



17 x 21 mm

1/1
OSI200571



16 x 23 mm

1/1
OSI200572



BOROWSKI
OSI200571 - OSI200576

270 mm



20 x 25 mm

1/1
OSI200573

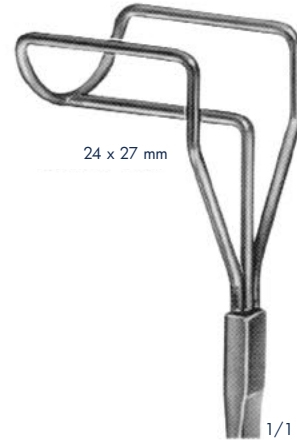

24 x 27 mm

1/1
OSI200574

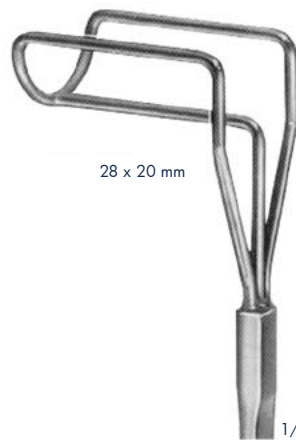

28 x 20 mm

1/1
OSI200575

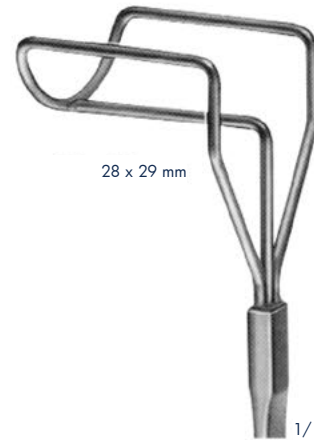

28 x 29 mm

1/1
OSI200576

Suction Cannulae

OSI160337

Ø 5 mm



1/1

OSI160338

Ø 5 mm



1/1

Olive
Ø 9 mm

DE BAKEY

OSI160338 160 mm
OSI160337 270 mm
with finger cut-off
and stylet

OSI160336

Ø 9 mm



1/1

Olive
Ø 6 - 10 mm

DE BAKEY

OSI160336
with central bore,
3.0 mm diam.
and lateral slots
275 mm

OSI160430

Ø 15 mm

OSI160335

Ø 10 mm

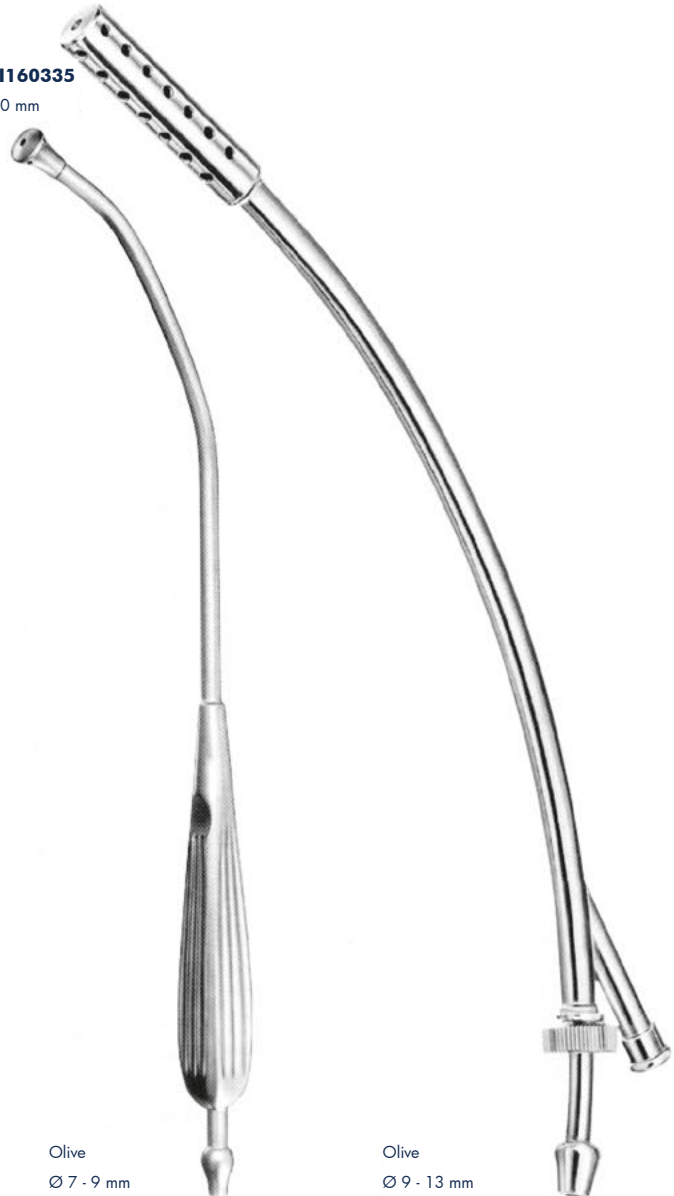

Olive
Ø 7 - 9 mm

YANKAUER

OSI160335
with central bore,
2.0 mm diam.
285 mm

Olive
Ø 9 - 13 mm

FINSTERER

OSI160430
combined suction - and
irrigation cannula
320 mm

Scalp Clips



CASPAR
OSI210614



CASPAR
OSI210631
Applicator for CASPAR scalp clips

Sterile Plastic Scalp Clips,
for single use (not resterilizable)
Sales unit: PA = 5 packages,
each containing 2 cartridges with
15 clips each = total 150 clips



OSI210282
with catch
Applying and removing forceps
150 mm



OSI210283
without catch
Applying and removing forceps
150 mm

Scalp Clips, Scalp Flap Forceps



1/2

RANEY
OSI210110

Scalp haemostatic clip
Sales unit:
PA = Package of 25 pieces



1/2

RANEY
OSI210111

Applying and removing
forceps for scalp
haemostatic clips OSI210110



1/2

OSI210109

Scalp haemostatic clip
Sales unit:
PZ = Package of 10 pieces



1/2

DANDY
OSI130186 - OSI130187

Scalp flap forceps,
curved to side
140 mm



OSI130186



1/1

OSI130187



1/1

DE MARTEL

OSI210284 135 mm

OSI210285 185 mm

Scalp flap forceps,
slightly curved

Galea Hooks



1/2

YASARGIL

OSI210117 - OSI210118

Spring hooks for galea fixation with bulldog clamp, to be fastened to covering drape



OSI210117



OSI210118



1/2

HUDSON

OSI180127

Hand drill, complete set, consisting of trepanning brace, cerebellar attachment and 4 burs OSI180128 - OSI180131

OSI180576

Brace only

OSI180136

Cerebellar attachment only

Perforators and burs on this page fit onto the hand drills OSI180576 and OSI180136



HUDSON

OSI180128

Ø 9 mm



HUDSON

OSI180129

Ø 14 mm



HUDSON

OSI180130

Ø 16 mm



HUDSON

OSI180131

Ø 22 mm



ADSON

OSI180577

Ø 15 mm



MC KENZIE

OSI180134

Ø 13 mm



CUSHING

OSI180132

Ø 14 mm



HUDSON

OSI180133

Ø 2 mm

1/2

Hand drill HUNDSON DOWNS



HUDSON DOWNS
OSI210286
Brace



HUDSON DOWNS
OSI210287
Extension piece



HUDSON DOWNS
OSI210288
Ø 10 mm



HUDSON DOWNS
OSI210289
Ø 12 mm



^{1/2}
HUDSON DOWNS
OSI210290
Ø 15 mm



HUDSON (LEWIS) DOWNS
OSI210291
Ø 10 mm



HUDSON (LEWIS) DOWNS
OSI210292
Ø 12 mm



^{1/2}
HUDSON (LEWIS) DOWNS
OSI210293
Ø 15 mm

Perforators and burrs on this page fit onto the hand drills OSI210286 - OSI210287



HUDSON DOWNS	HUDSON DOWNS	HUDSON DOWNS	HUDSON DOWNS	HUDSON DOWNS	HUDSON DOWNS	HUDSON DOWNS	HUDSON DOWNS	HUDSON DOWNS	MC KENZIE	MC KENZIE
OSI210294	OSI210295	OSI210296	OSI210297	OSI210298	OSI210299	OSI210300	OSI210301	OSI210302	OSI210303	OSI210303
Ø 11 mm	Ø 13 mm	Ø 16 mm	Ø 11 mm	Ø 13 mm	Ø 16 mm	Ø 19 mm	Ø 22 mm	Ø 16 mm		

Wire Saws and Conductor

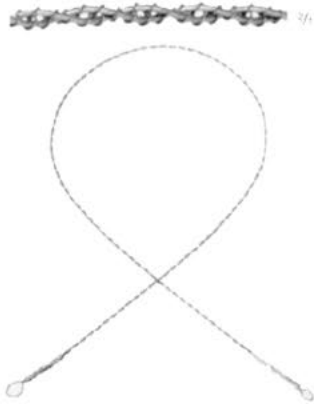

OLIVECRONA
OSI210101 300 mm
OSI210102 400 mm
OSI210103 500 mm
OSI210104 700 mm

Wire saw
 Sales unit:
 PA = Package of 5 pieces

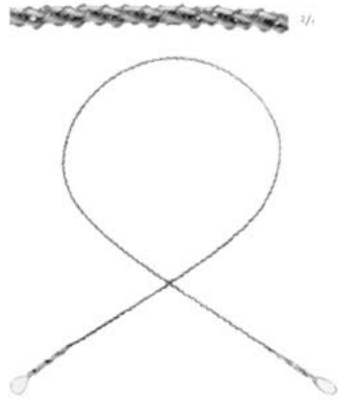

GIGLI
OSI210304 300 mm
OSI210305 400 mm
OSI210306 500 mm

Wire saw, fine, 7 wires twisted
 Sales unit:
 PA = Package of 5 pieces
OSI210632 500 mm

Wire saw, coarse, 4 wires twisted
 Sales unit:
 = Package of 5 pieces



GIGLI
OSI210106
 Handle for wire saws



TEBSCHÉ
OSI210307

Conductor for GIGLI and
 OLIVECRONA wire saws,
 malleable
 250 mm

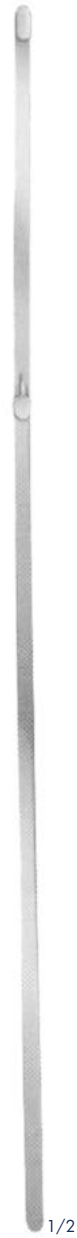

DE MARTEL
OSI210107

Conductor for GIGLI and
 OLIVECRONA wire saws,
 flexible
 350 mm

Skull Punch Bore Hole Protection Forceps, Neurosurgical Pattie tray



DAHLGREN
OSI210308
Skull punch
with 2 extra hooks
210 mm

1/2



OSI210309
Bore holding protection forceps
205 mm

1/2

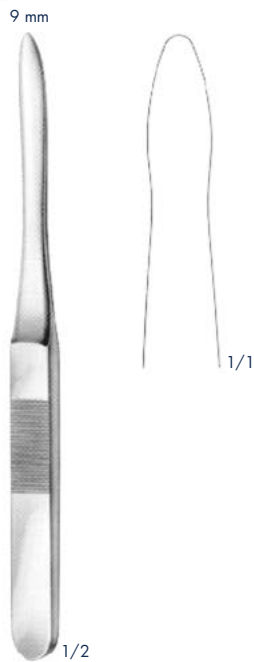

CAIRNS
OSI190647
Bone flap elevator
175 mm

1/2

1/1

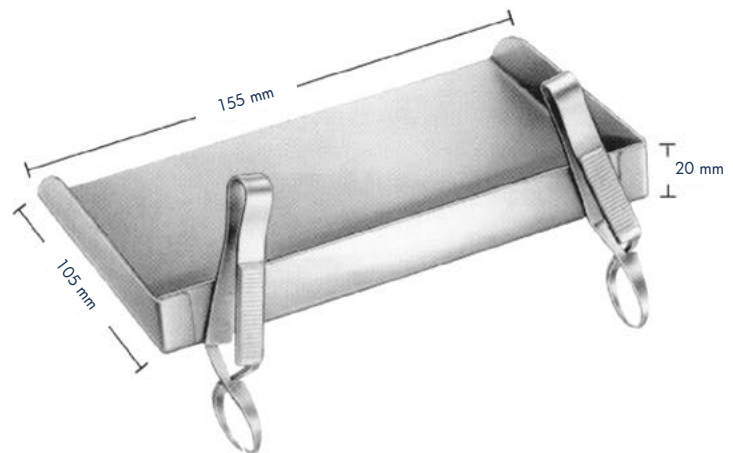

OSI210310
Neurosurgical pattie tray fitted with 2 towel clips

Dura-Scissors

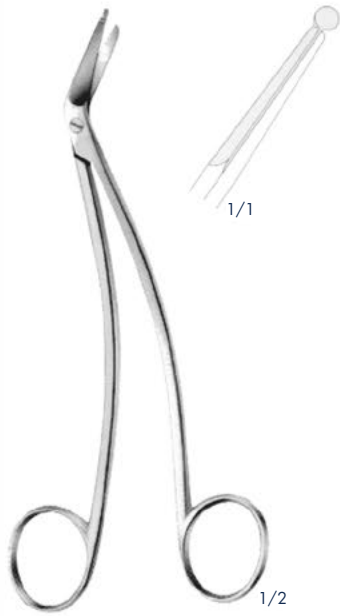

SCHMIEDEN-TAYLOR
OSI110307
 155 mm



OLIVECRONA
OSI110304



STRULLY
OSI110674
 pointed
 220 mm



STRULLY
OSI110305
 probe pointed
 220 mm

Fine Retractors, Dura Hooks



CAIRNS
OSI210311
130 mm



FRAZIER
OSI150506
130 mm



TÖNNIS
OSI210178
150 mm



MÜLLER
OSI150509
150 mm

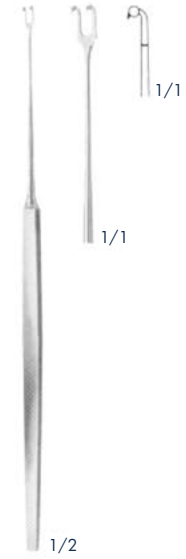

MÜLLER
OSI150510
150 mm



OSI150513
185 mm



FISCH
OSI150514
185 mm



GILLIES
OSI220150 - OSI220151
180 mm



COTTLE
OSI260407
160 mm

Raspatories, Dissectors



1/2

YASARGIL

OSI210312 4 mm

Dissector with flexible shaft for children
195 mm



1/2

YASARGIL

OSI210633 7 mm

Dissector with flexible shaft for adults
195 mm



1/2



1/1

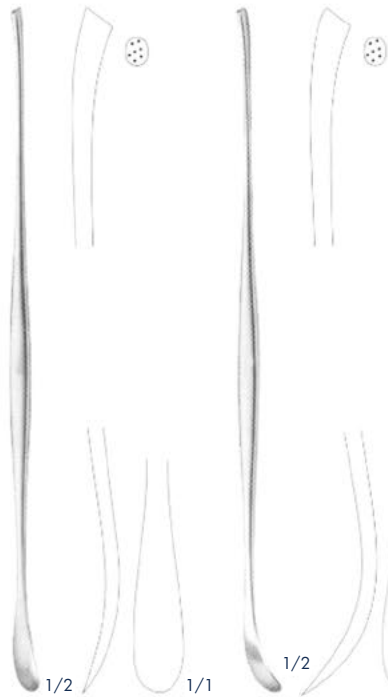

1/2

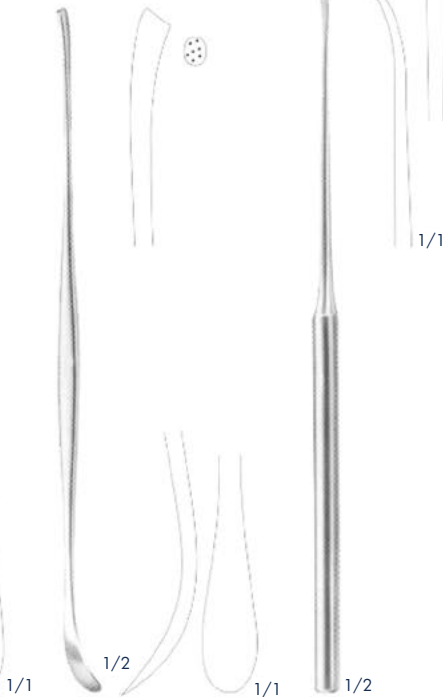

1/2

1/1



1/2

1/1

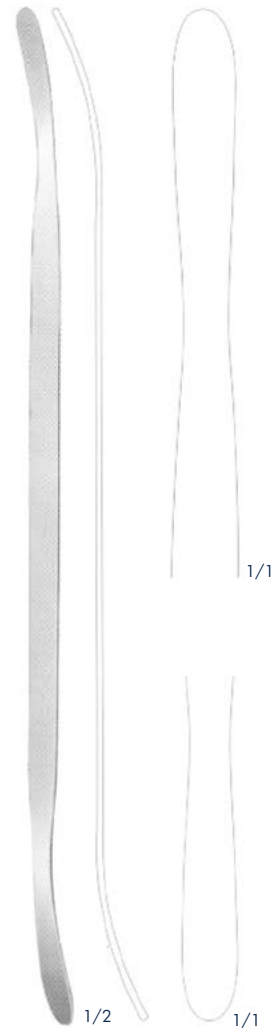

1/2

1/1

PENFIELD OSI210128

Fig. 1

double-ended
175 mm

PENFIELD OSI210129

Fig. 2

double-ended
195 mm

PENFIELD OSI210130

Fig. 3

double-ended
195 mm

PENFIELD OSI210131

Fig. 4

slightly curved
205 mm

PENFIELD OSI210132

Fig. 5

double-ended, slightly curved
290 mm

Raspatories, Dissectors, Osteophyte Chisel



FREER - YASARGIL
OSI260370
 sharp/sharp
 185 mm



KILLIAN
OSI260371
 sharp/blunt
 185 mm

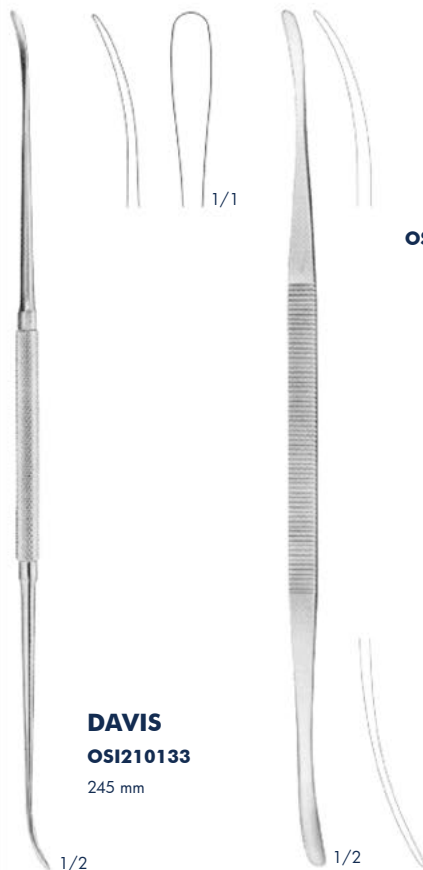

DAVIS
OSI210133
 245 mm



OSI210119 OSI210313

TOENNIS
OSI210119 - OSI210313
 blunt/blunt
 240 mm



ALLEN
OSI210314
 Osteophyte chisel
 and scraper
 230 mm

Raspatories, Dissectors, Grooved Director



SWEDISH

OSI210315 180 mm
light pattern

OSI210316 200 mm
heavy pattern



PENNYBACKER

OSI210317
Probe disector
230 mm

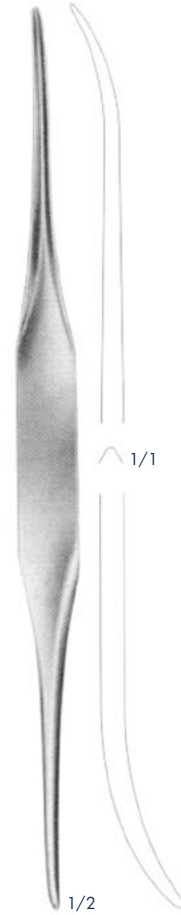

TOENNIS

OSI210318
Grooved director
240 mm

Brain Spatulas, flat

		Length	Width
	OSI210319	200 mm	7 + 8 mm
	OSI210320	200 mm	10 + 11 mm
	OSI210321	200 mm	13 + 14 mm
	OSI210322	200 mm	16 + 17 mm
	OSI210323	200 mm	19 + 20 mm
OSI210324	200 mm	22 + 25 mm	
malleable			

		Length	Width
	OSI150474	200 mm	12 mm
	OSI150475	200 mm	17 mm
malleable			

		Length	Width
	OSI210325	200 mm	9 mm
	OSI210326	200 mm	12 mm
	OSI210327	250 mm	12 mm
malleable			

		Length	Width
	OSI210328	180 mm	7 + 9 mm
	OSI210329	180 mm	11 + 13 mm
	OSI210330	180 mm	15 + 18 mm
	OSI210331	180 mm	18 + 22 mm
malleable			

	OLIVECRONA	Length	Width
	OSI210150	180 mm	7 + 9 mm
	OSI210151	180 mm	11 + 13 mm
	OSI210152	180 mm	15 + 18 mm
	OSI210153	180 mm	18 + 22 mm
flexible			

Brain Spatulas with round shaft

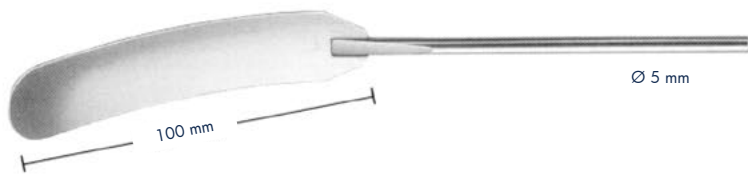

	Length	Width
OSI210332	200 mm	14 mm
OSI210333	200 mm	17 mm
OSI210334	200 mm	20 mm

malleable



	Length	Width
HEIFETZ		
OSI210335	155 mm	8 mm
OSI210336	155 mm	11 mm
OSI210337	155 mm	14 mm
OSI210338	155 mm	17 mm

flexible

Ventriculopuncture Cannulae, Suction Cannula



FRAZIER
OSI210339
 Ø 3 mm

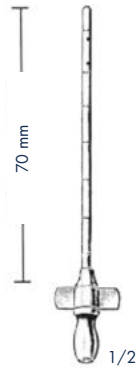

OSI210340 Ø 2 mm
OSI210341 Ø 2,5 mm



JEFFERSON
OSI210342 80 mm
OSI210343 100 mm



CONE
OSI210344 Ø 1,6 mm
OSI210345 Ø 2,0 mm



DANDY
OSI210346 Ø 2,0 mm



CUSHING-CAIRNS
OSI210347 Ø 2,3 mm
OSI210348 Ø 2,6 mm



ADSON
OSI160339 Ø 4 mm
 with finger valve
 190 mm

Suction Cannula



FRAZIER

OSI160217 Ø 3 mm
OSI160218 Ø 5 mm
 with obturator and finger cut-off



CONE

OSI160345
 Handle only for OSI160346 and
 OSI160347 with finger cut-off



CONE

OSI160346 Ø 4 mm
OSI160347 Ø 5 mm
 180 mm
 to be used with handle OSI160345



YASARGIL

	usable length	Ø diam.
OSI160406	130 mm	1,5 mm
OSI160201	150 mm	1,5 mm
OSI160407	180 mm	1,5 mm
OSI160408	220 mm	1,5 mm
OSI160409	130 mm	2,0 mm
OSI160410	150 mm	2,0 mm
OSI160202	180 mm	2,0 mm
OSI160411	220 mm	2,0 mm

OSI160412

	usable length	Ø diam.
OSI160412	130 mm	2,5 mm
OSI160203	150 mm	2,5 mm
OSI160413	180 mm	2,5 mm
OSI160414	220 mm	2,5 mm
OSI160415	130 mm	3,5 mm
OSI160204	150 mm	3,5 mm
OSI160416	180 mm	3,5 mm
OSI160417	220 mm	3,5 mm
OSI160459	180 mm	4,5 mm

with LUER hub
 Olive
 Ø 6,5 - 9 mm

Nerve Retractors, Nerve Root Retractors

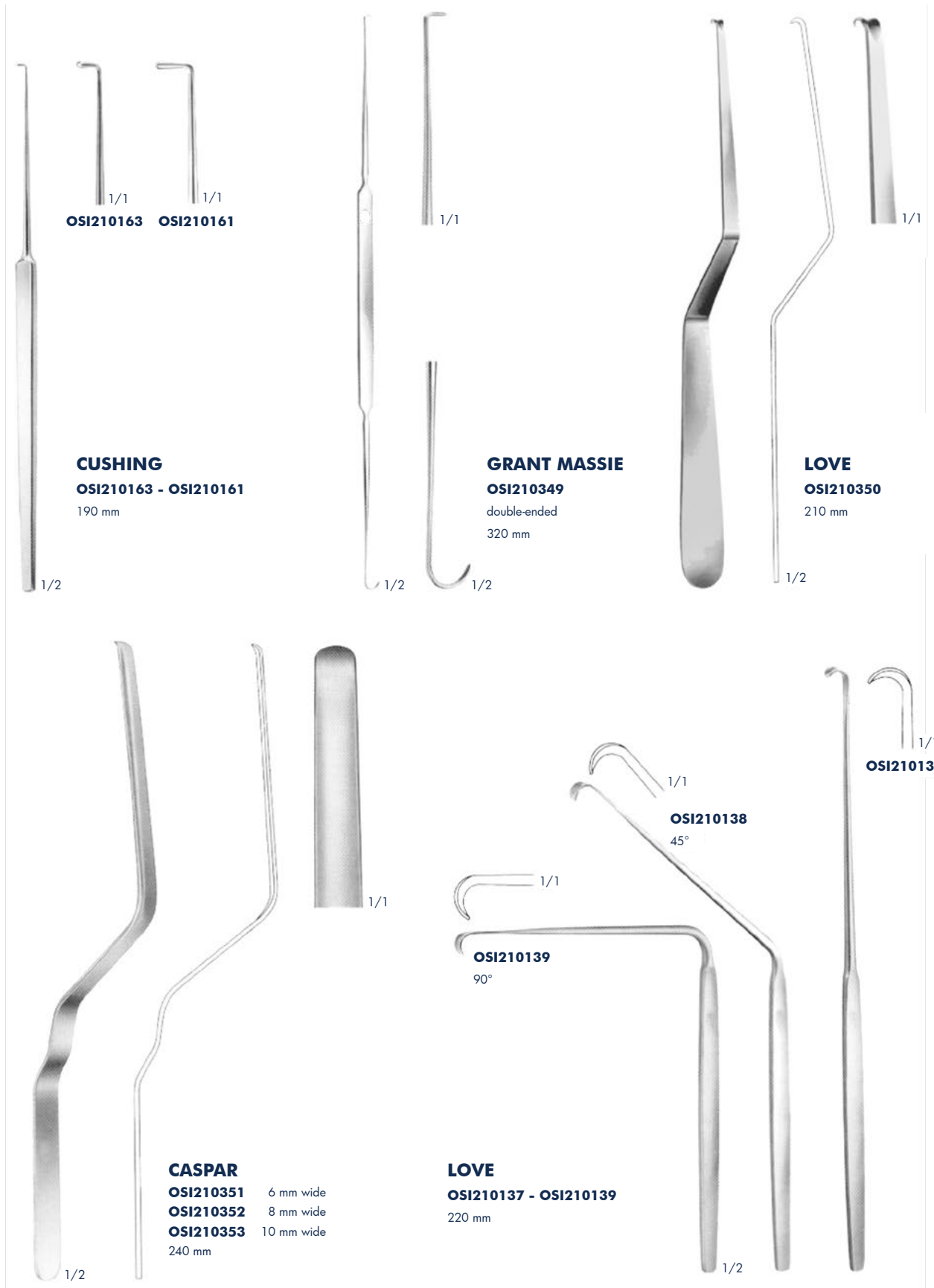

Nerve Retractors, Nerve Root Retractors



OSI210354
3 mm

OSI210355
5 mm

OSI210356
7 mm



HESS
OSI210356 - OSI210354
175 mm



O'CONNELL
OSI210357
double-ended
220 mm

Skull Traction Tongs for vertabrea treatment



CRUTCHFIELD
OSI210358
for children



CRUTCHFIELD
OSI210359
medium size



OSI210361



OSI210362
Drill point only



OSI210363
pins for children
Ø 3,5 mm

Sales unit : PR = 1 pair

OSI210364

pins for adults
Ø 4,5 mm

Sales unit : PR = 1 pair



STRATFORD (CONE)
OSI210360
complete



OSI210365
Combined spanner and wrench

Including 1 pair of each OSI210363
and OSI210364 pins and one combined
spanner and wrench OSI210365

Skull Traction Tongs for vertebrae treatment

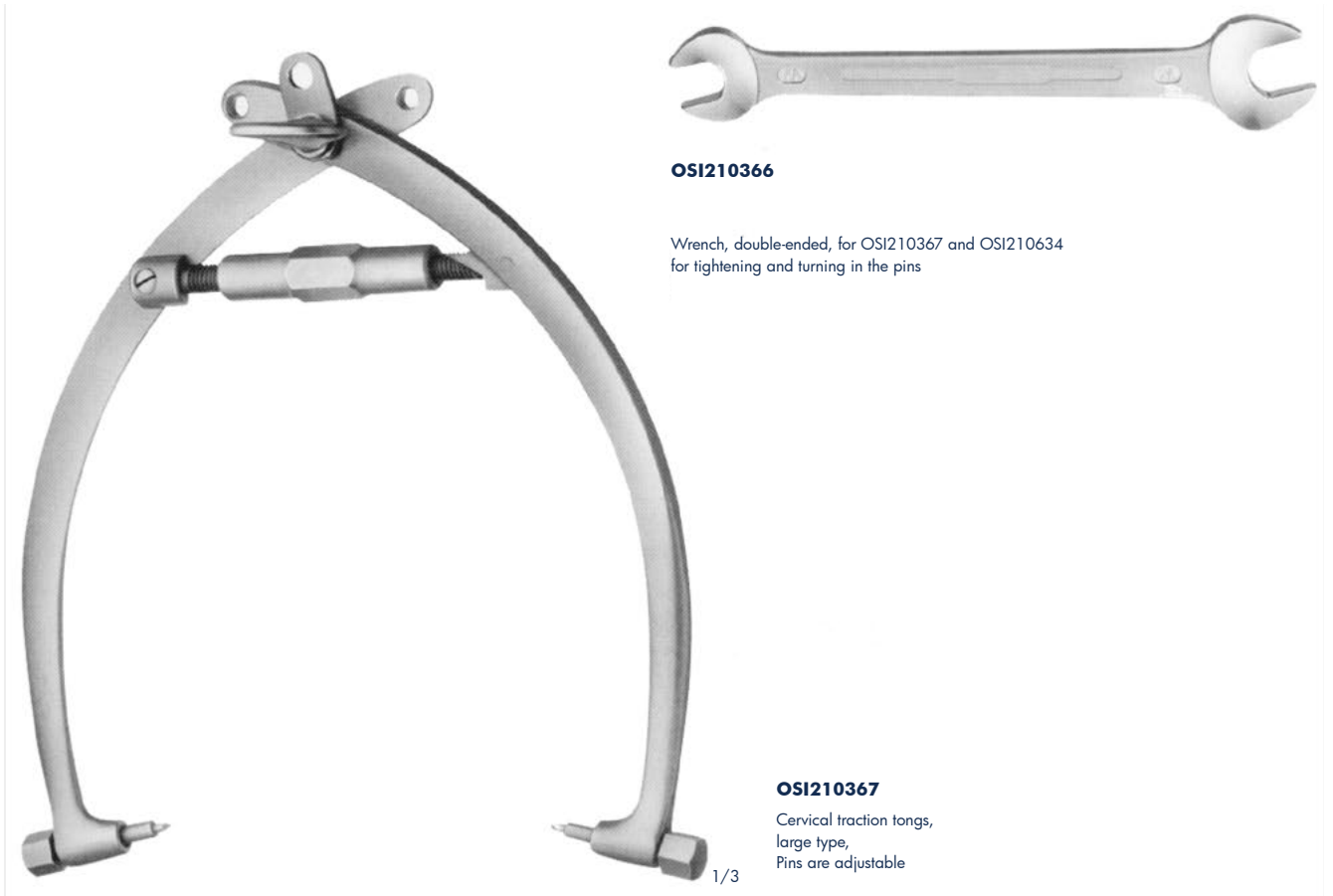

OSI210366

Wrench, double-ended, for OSI210367 and OSI210634 for tightening and turning in the pins

OSI210367

Cervical traction tongs, large type, Pins are adjustable

1/3

Punches

Angled positions for punches

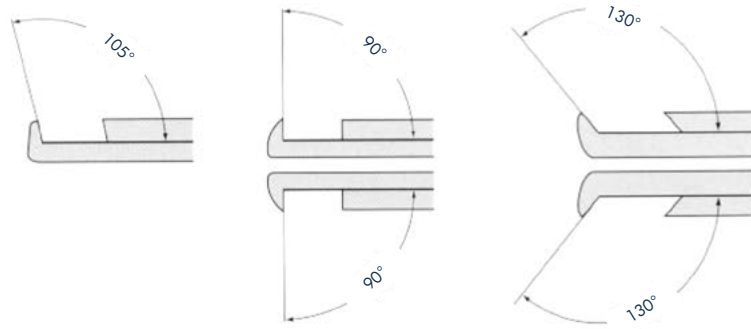

90° nach oben schneidend
upward cutting

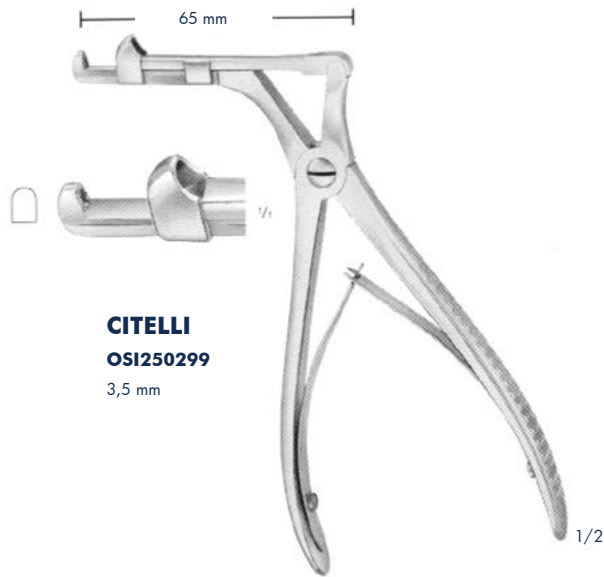

90° nach oben schneidend
upward cutting

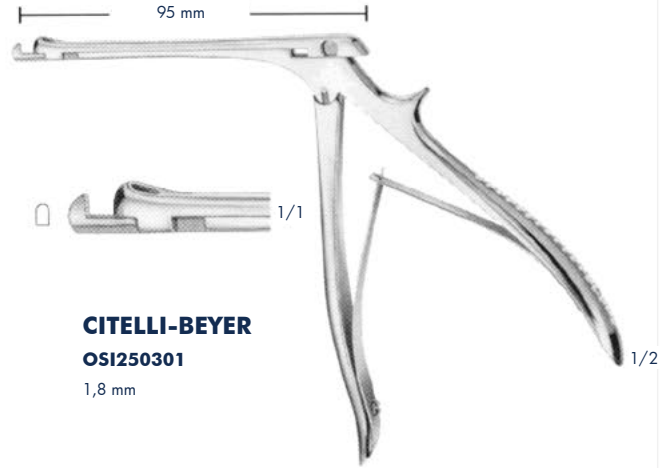

90° nach oben schneidend
upward cutting

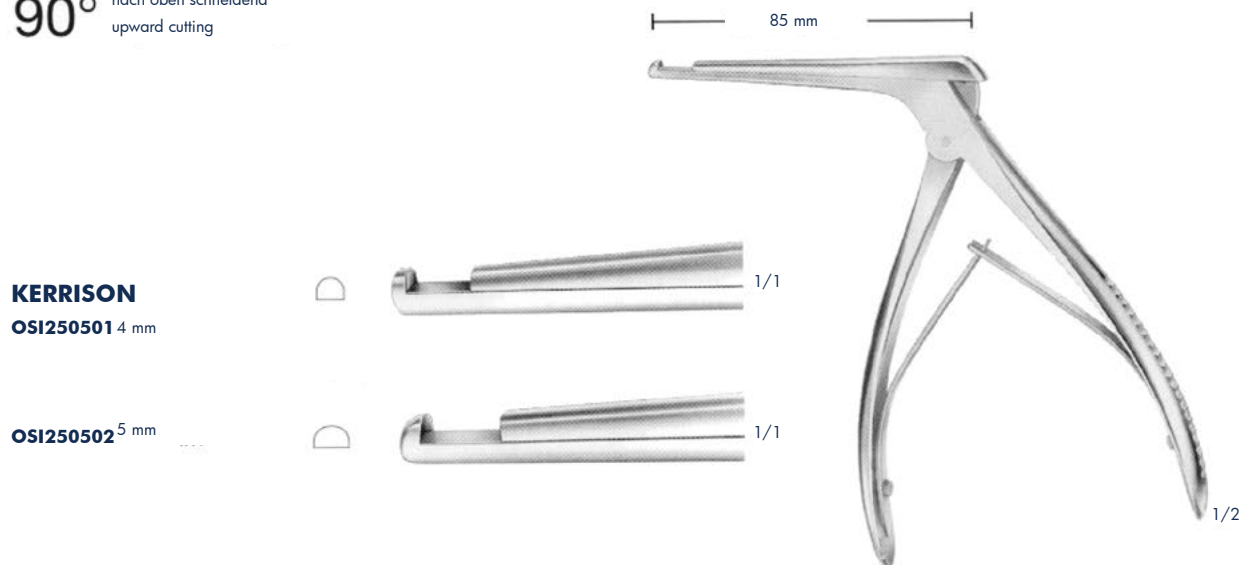

Punches

90° upward cutting

HAJEK-KOFLER
OSI250482 3,3 mm

OSI250480 4,0 mm

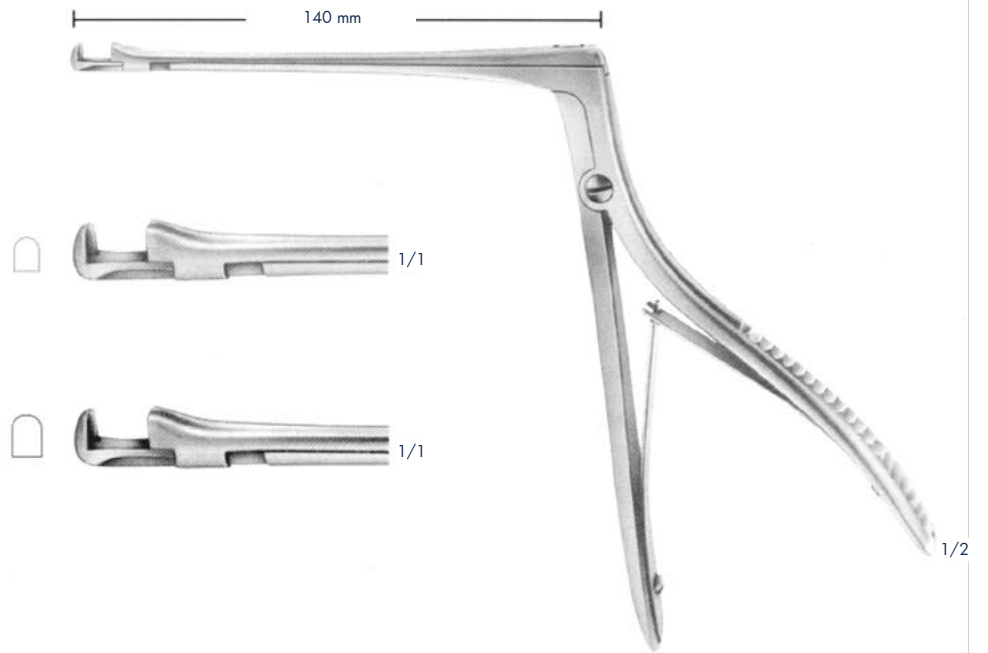

90° downwards cutting

HAJEK-KOFLER
OSI250483 3,3 mm

OSI250481 4,0 mm

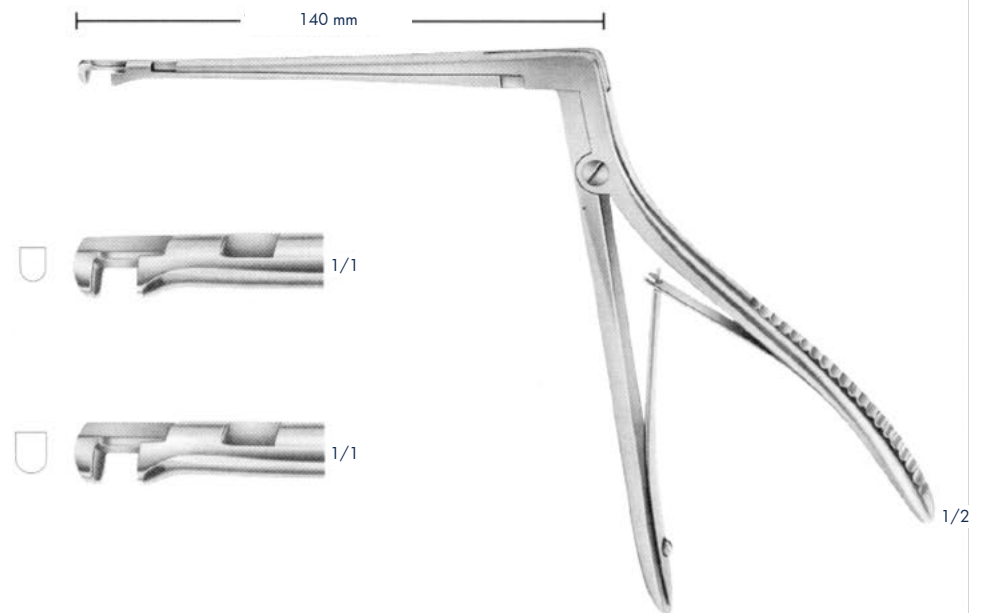

Punches

90° turnable 360°

KOFLER
OSI260781 3,0 mm

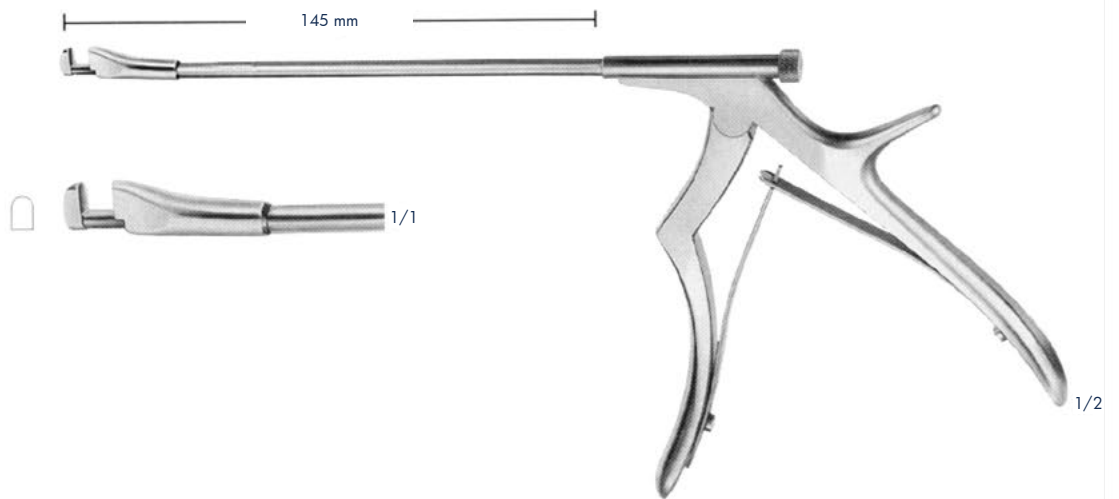

90° turnable 360°

HAJEK-KOFLER
OSI260782 4 mm

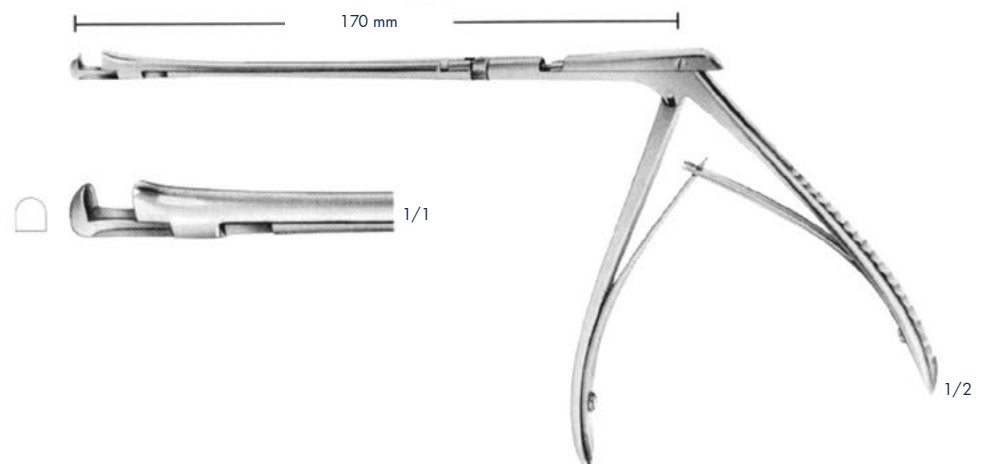

Punches

105° upward cutting

RICHTER
OSI210368 5 mm

fenestrated

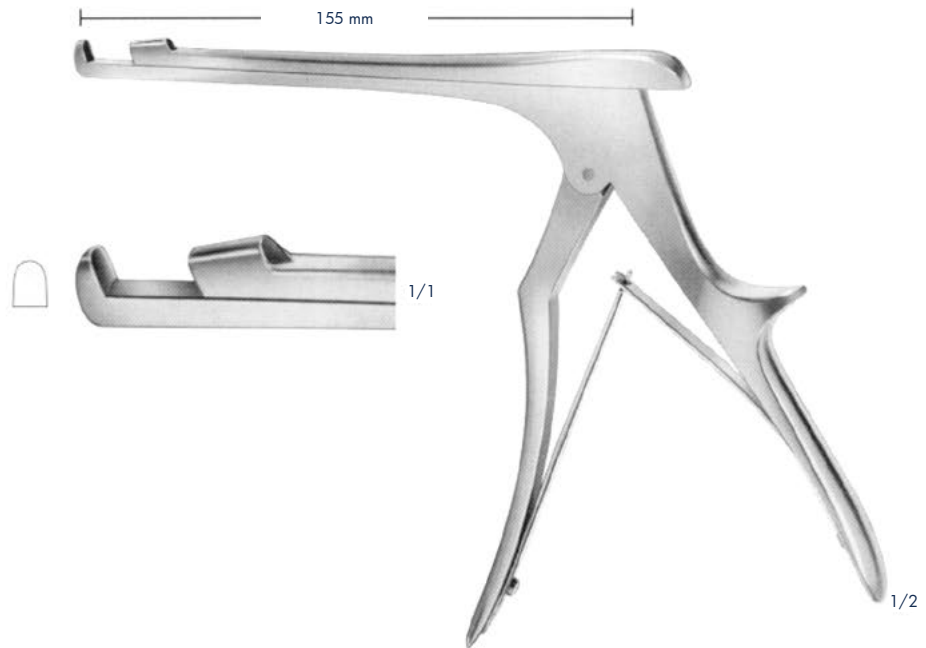

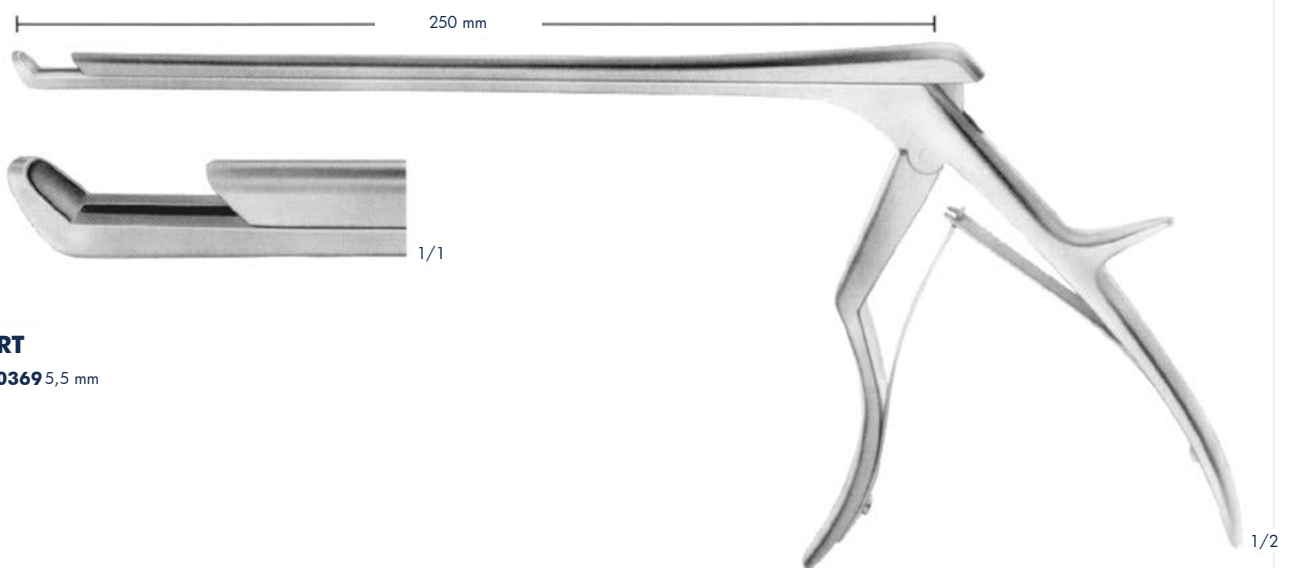

130° upward cutting

SYPERT
OSI210369 5,5 mm



KERRISON-Punches, detachable



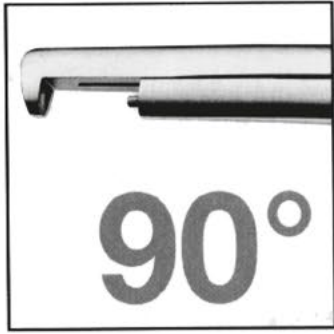
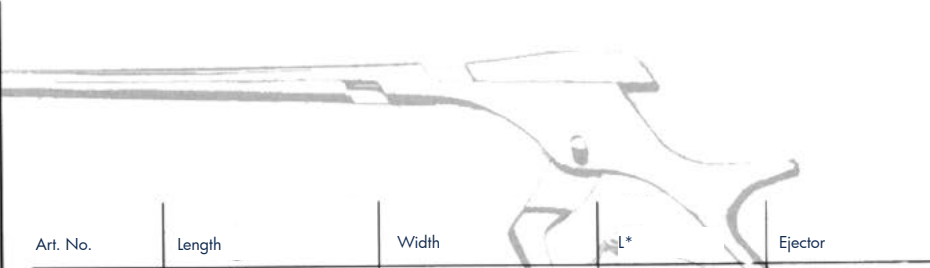

Art. No.	Length	Width	L*	Ejector
OSI210370	180 mm	1 mm	8 mm	-
OSI210371	180 mm	2 mm	9 mm	-
OSI210372	180 mm	3 mm	10 mm	✓
OSI210373	180 mm	4 mm	12 mm	✓
OSI210374	180 mm	5 mm	12 mm	✓
OSI210375	230 mm	2 mm	9 mm	-
OSI210376	230 mm	3 mm	10 mm	✓
OSI210377	230 mm	4 mm	12 mm	✓
OSI210378	230 mm	5 mm	12 mm	✓

























Art. No.	Length	Width	L*	Ejector
OSI210379	180 mm	1 mm	8 mm	-
OSI210380	180 mm	2 mm	9 mm	-
OSI210381	180 mm	3 mm	10 mm	✓
OSI210382	180 mm	4 mm	12 mm	✓
OSI210383	180 mm	5 mm	12 mm	✓
OSI210384	230 mm	2 mm	9 mm	-
OSI210385	230 mm	3 mm	10 mm	✓
OSI210386	230 mm	4 mm	12 mm	✓
OSI210387	230 mm	5 mm	12 mm	✓

KERRISON-Punches, detachable



130°

Art. No.	Length	Width		L*	Ejector
OSI210388	180 mm	1 mm		8 mm	-
OSI210389	180 mm	2 mm		9 mm	-
OSI210390	180 mm	3 mm		10 mm	✓
OSI210391	180 mm	4 mm		12 mm	✓
OSI210392	180 mm	5 mm		12 mm	✓
OSI210393	180 mm	1 mm		8 mm	-
OSI210394	180 mm	2 mm		9 mm	-
OSI210395	180 mm	3 mm		10 mm	✓
OSI210396	180 mm	4 mm		12 mm	✓
OSI210397	180 mm	5 mm		12 mm	✓
OSI210398	200 mm	3 mm		17 mm	✓
OSI210399	200 mm	4 mm		17 mm	✓
OSI210400	200 mm	5 mm		17 mm	✓
OSI210401	200 mm	6 mm		17 mm	✓
OSI210402	230 mm	2 mm		9 mm	-
OSI210403	230 mm	3 mm		10 mm	✓
OSI210404	230 mm	4 mm		12 mm	✓
OSI210405	230 mm	5 mm		12 mm	✓
OSI210406	230 mm	2 mm		9 mm	-
OSI210407	230 mm	3 mm		10 mm	✓
OSI210408	230 mm	4 mm		12 mm	✓
OSI210409	230 mm	5 mm		12 mm	✓

Colour Coding:
Gold on the distal end
thin footplate

Colour Coding:
Gold on the distal end
thin footplate

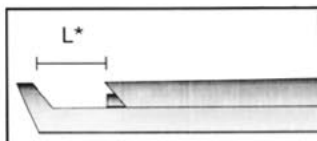

KERRISON-Punches, detachable



Art. No.	Length	Width		L*	Ejector
OSI210410	180 mm	1 mm		8 mm	-
OSI210411	180 mm	2 mm		9 mm	-
OSI210412	180 mm	3 mm		10 mm	✓
OSI210413	180 mm	4 mm		12 mm	✓
OSI210414	180 mm	5 mm		12 mm	✓
OSI210415	180 mm	1 mm		8 mm	-
OSI210416	180 mm	2 mm		9 mm	-
OSI210417	180 mm	3 mm		10 mm	✓
OSI210418	180 mm	4 mm		12 mm	✓
OSI210419	180 mm	5 mm		12 mm	✓
OSI210420	230 mm	2 mm		9 mm	-
OSI210421	230 mm	3 mm		10 mm	✓
OSI210422	230 mm	4 mm		12 mm	✓
OSI210423	230 mm	5 mm		12 mm	✓

Colour Coding:
Gold on the distal end
thin footplate

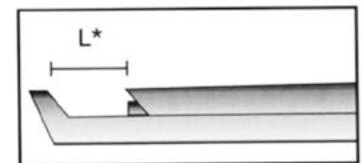

KERRISON-Punches, non detachable

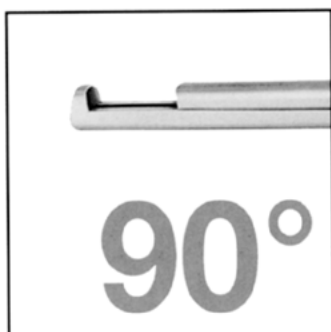

Art. No.	Length	Jaw Position	Width
OSI200234	180 mm	upward	1 mm
OSI200235	180 mm	upward	2 mm
OSI200236	180 mm	upward	3 mm
OSI200237	180 mm	upward	4 mm
OSI200238	180 mm	upward	5 mm
OSI200424	230 mm	upward	2 mm
OSI200425	230 mm	upward	3 mm
OSI200426	230 mm	upward	4 mm
OSI200427	230 mm	upward	5 mm

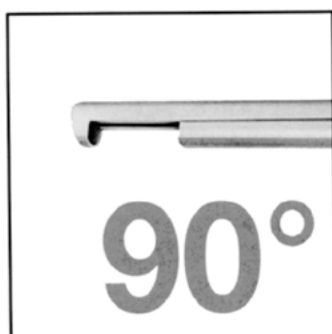





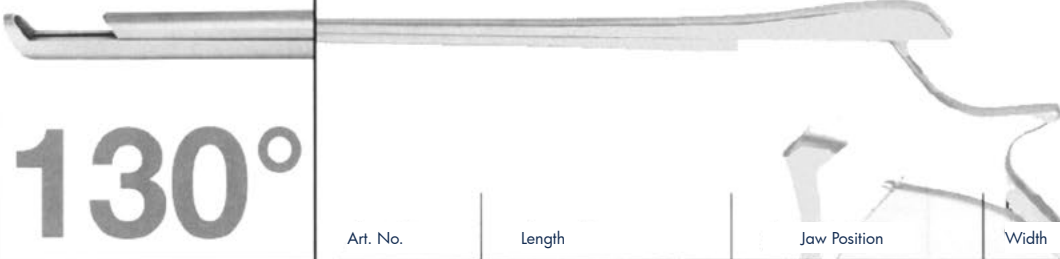

















Art. No.	Length	Jaw Position	Width
OSI200240	180 mm	downwards	1 mm
OSI200241	180 mm	downwards	2 mm
OSI200242	180 mm	downwards	3 mm
OSI200243	180 mm	downwards	4 mm
OSI200244	180 mm	downwards	5 mm
OSI200428	230 mm	downwards	2 mm
OSI200429	230 mm	downwards	3 mm
OSI200430	230 mm	downwards	4 mm
OSI200431	230 mm	downwards	5 mm

KERRISON-Punches, non detachable



130°

Art. No.	Length	Jaw Position	Width	
OSI200246	180 mm	upwards	1 mm	
OSI200247	180 mm	upwards	2 mm	
OSI200248	180 mm	upwards	3 mm	
OSI200249	180 mm	upwards	4 mm	
OSI200250	180 mm	upwards	5 mm	
OSI200432	180 mm	upwards	1 mm	
OSI200433	180 mm	upwards	2 mm	
OSI200434	180 mm	upwards	3 mm	
OSI200435	180 mm	upwards	4 mm	
OSI200436	180 mm	upwards	5 mm	
OSI200437	200 mm	upwards	3 mm	
OSI200438	200 mm	upwards	4 mm	
OSI200439	200 mm	upwards	5 mm	
OSI200440	200 mm	upwards	6 mm	
OSI200441	230 mm	upwards	2 mm	
OSI200442	230 mm	upwards	3 mm	
OSI200443	230 mm	upwards	4 mm	
OSI200444	230 mm	upwards	5 mm	
OSI200445	230 mm	upwards	2 mm	
OSI200446	230 mm	upwards	3 mm	
OSI200447	230 mm	upwards	4 mm	
OSI200448	230 mm	upwards	5 mm	







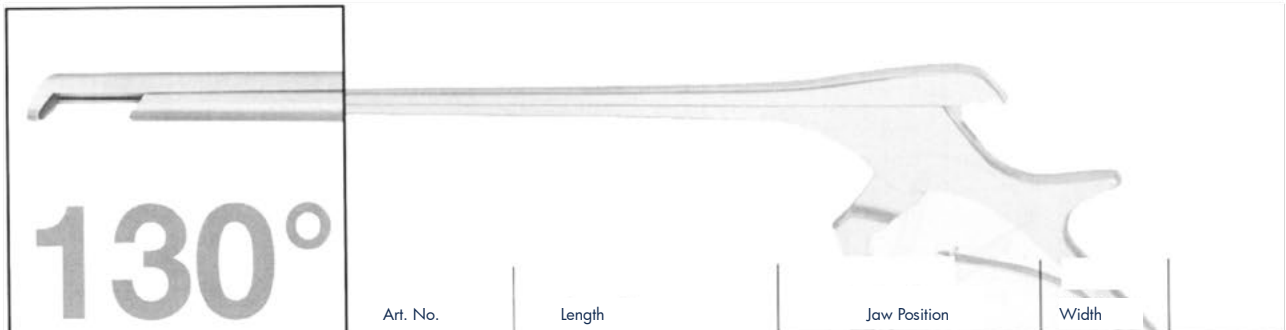







Colour Coding:
Gold on the distal end
thin footplate

Colour Coding:
Gold on the distal end
thin footplate

KERRISON-Punches, non detachable



130°

Art. No.	Length	Jaw Position	Width	
OSI200449	180 mm	downwards	1 mm	
OSI200450	180 mm	downwards	2 mm	
OSI200451	180 mm	downwards	3 mm	
OSI200452	180 mm	downwards	4 mm	
OSI200453	180 mm	downwards	5 mm	
OSI200454	180 mm	downwards	1 mm	
OSI200455	180 mm	downwards	2 mm	
OSI200456	180 mm	downwards	3 mm	
OSI200457	180 mm	downwards	4 mm	
OSI200458	180 mm	downwards	5 mm	
OSI200459	230 mm	downwards	2 mm	
OSI200460	230 mm	downwards	3 mm	
OSI200461	230 mm	downwards	4 mm	
OSI200462	230 mm	downwards	5 mm	

Colour Coding:
Gold on the distal end
thin footplate

Rongeurs

Angled positions for rongeurs

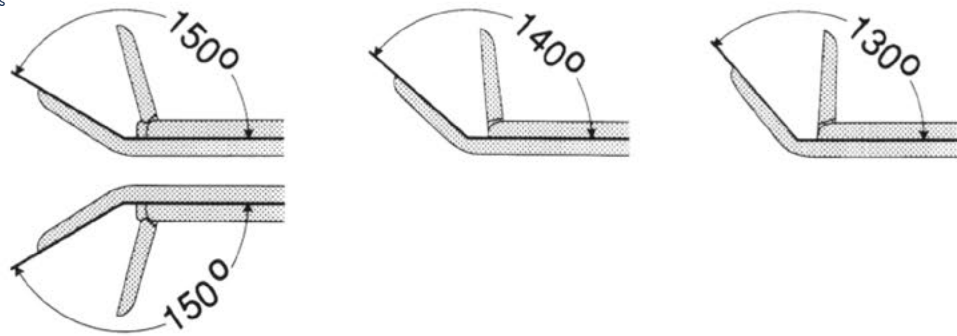

WEIL-BLAKESLEY

- OSI25044£** 3,0 mm
- OSI25044§** 3,6 mm
- OSI25045©** 4,2 mm
- OSI25045¹** 4,8 mm
- OSI25045²** 5,8 mm

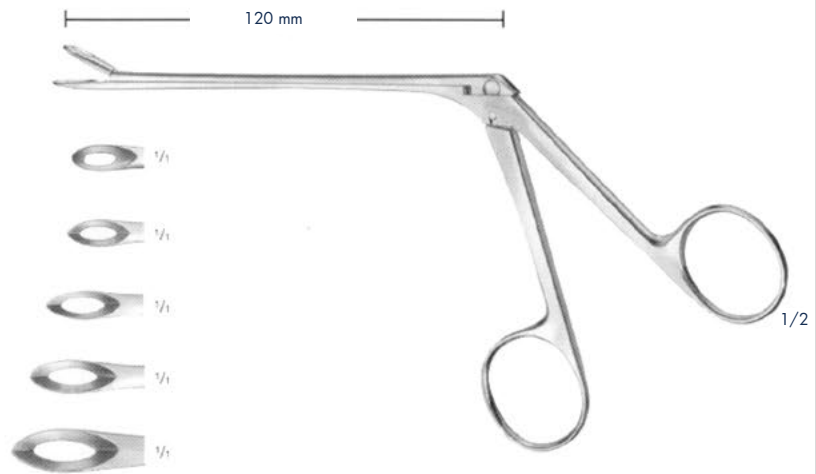

140°

WEIL-BLAKESLEY

- OSI25045³** 3,6 mm
- OSI25045£** 4,2 mm
- OSI25045©** 4,8 mm

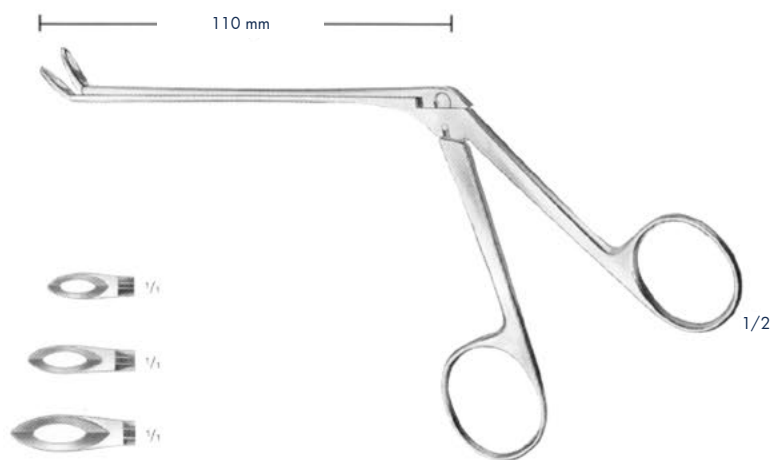

Rongeurs

HENCKEL-TILLEY

OSI260783 6,5 mm

Shaft graduated in cm

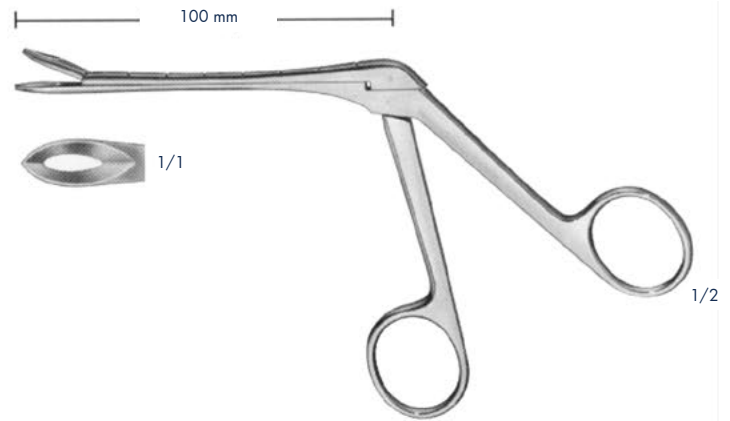

MACKY MOD. WEIL-BLAKESLEY

OSI260784 3,5 mm

with suction tube

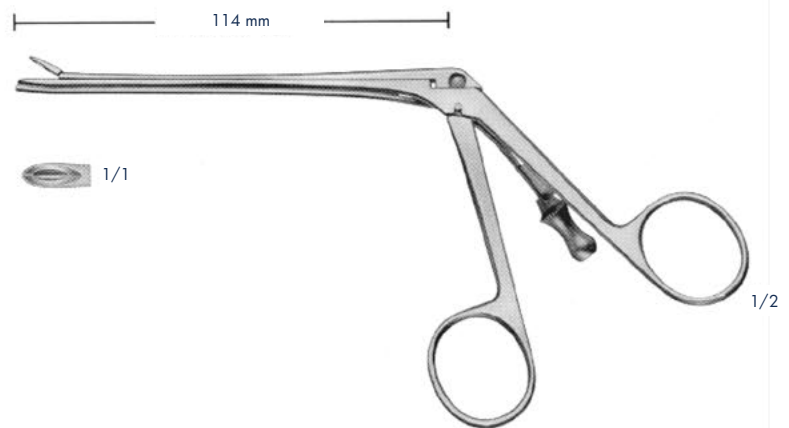

140°

MACKY MOD. WEIL-BLAKESLEY

OSI250829 3,5 mm

with suction tube



Rongeurs

ST BARTS
OSI250830 3,0 mm



140°

ST BARTS
OSI250831 3,0 mm



140°

ST BARTS
OSI250832 3,0 mm

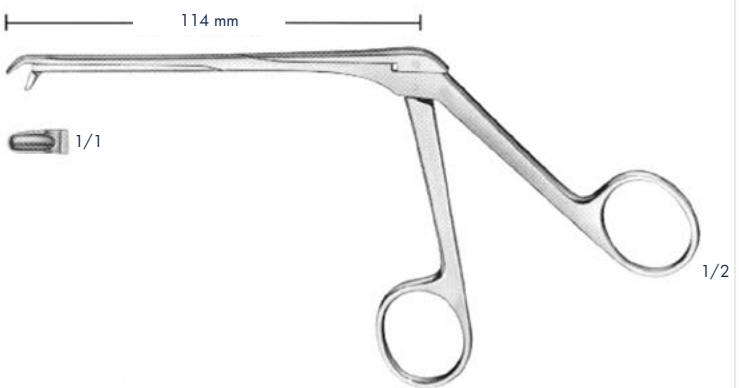

MACKAY "CHOMPER"
OSI250833 5,5 mm

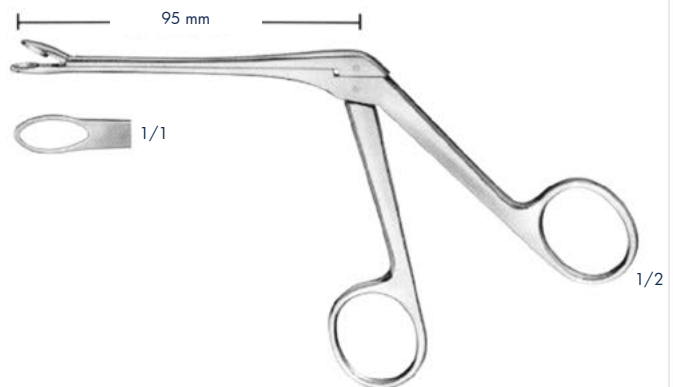

Rongeurs

TAKAHASHI
OSI250443 3 mm



130°

TAKAHASHI
OSI250444 3 mm

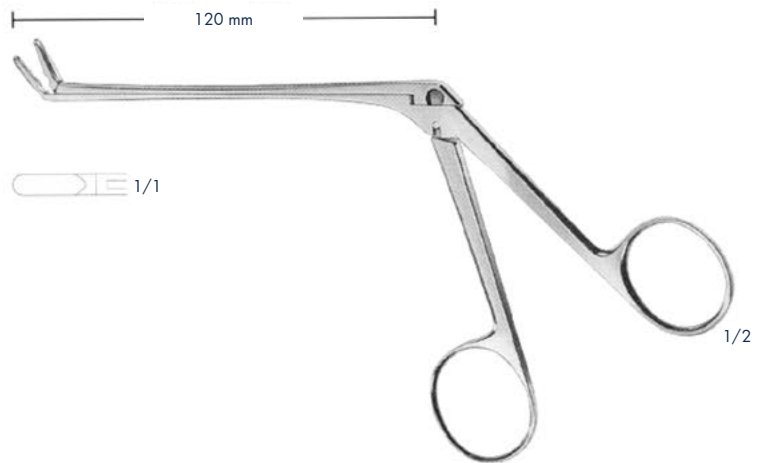

LOVE-GRUENWALD

OSI210252 2 x 10 mm
OSI210261 3 x 10 mm



SPURLING
OSI210270 4 x 10 mm



Rongeurs

BECK

OSI210463 2 mm



CUSHING

OSI210464 4 mm

OSI210465 5 mm

OSI210466 6 mm



150°

CUSHING

OSI210467 3 mm

OSI210468 4 mm

OSI210469 5 mm

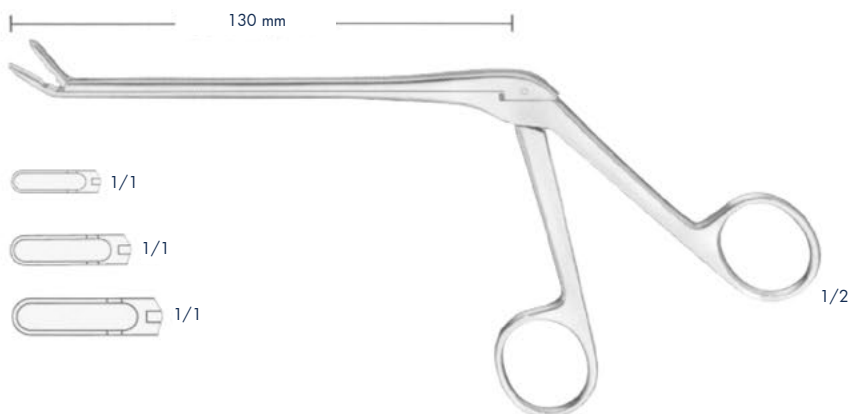

Rongeurs

150°

CUSHING

OSI210267 3 mm

OSI210276 4 mm



PENNYBACKER

OSI210470 3 mm

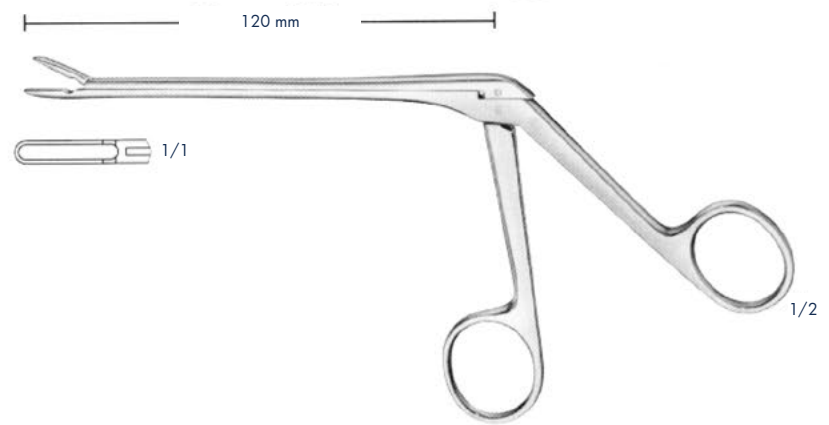

STAMMBERGER

OSI260800

2,5 mm

OSI260801

2,5 mm

OSI260802

2,5 mm

1/1

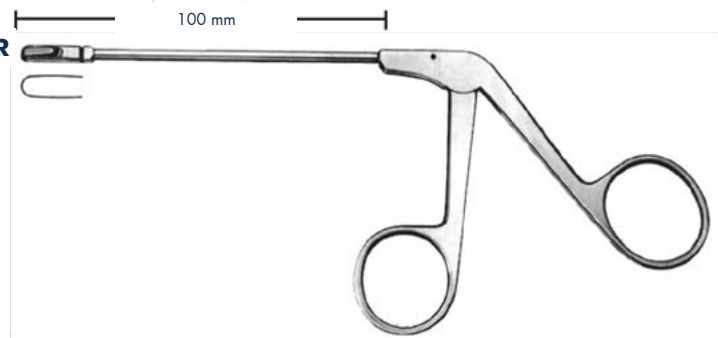

OSI260820

Straight

OSI260821

Curved right

OSI260822

Curved left

1/1

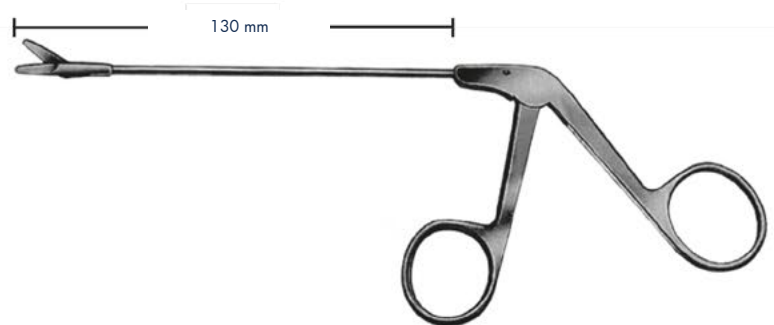

Rongeurs

CASPAR

OSI210253 2 mm

OSI210262 3 mm

OSI210271 4 mm

OSI210471 5 mm

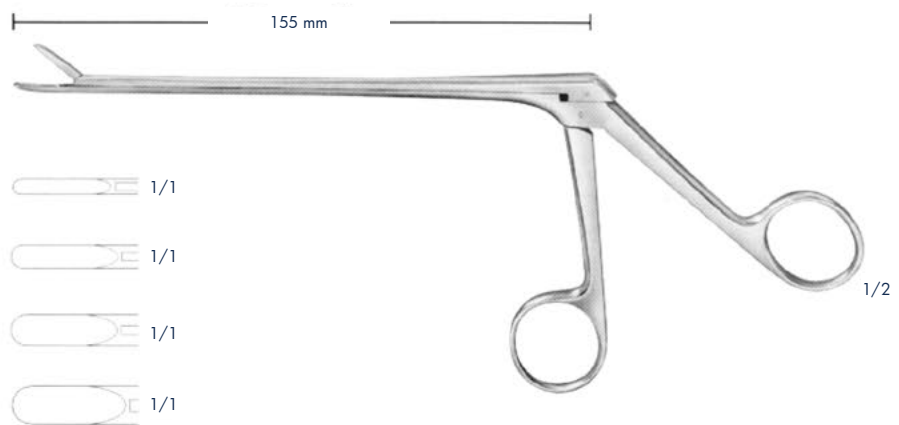

150°

CASPAR

OSI210256 2 mm

OSI210265 3 mm

OSI210274 4 mm



150°

unteres Maulteil beweglich
lower part of jaw movable

CASPAR

OSI210259 2 mm

OSI210268 3 mm

OSI210277 4 mm

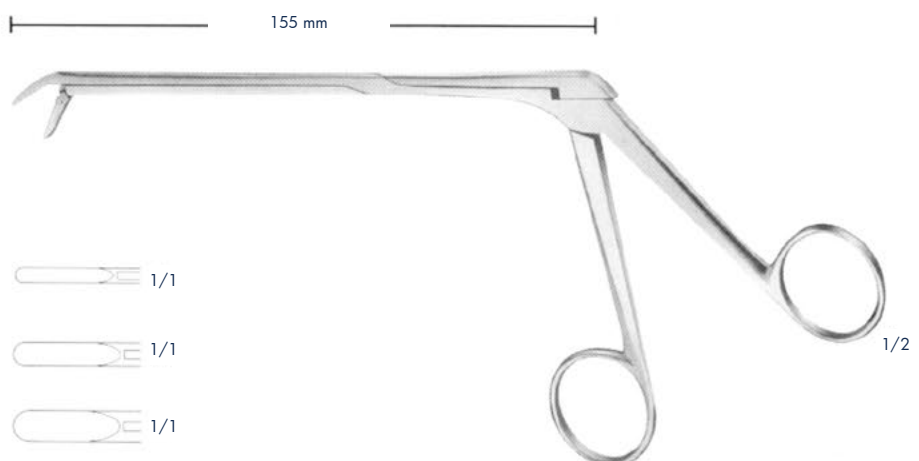

Rongeurs

CASPAR

length of shaft
140 mm

length of shaft
160 mm

length of shaft
185 mm

size of jaws

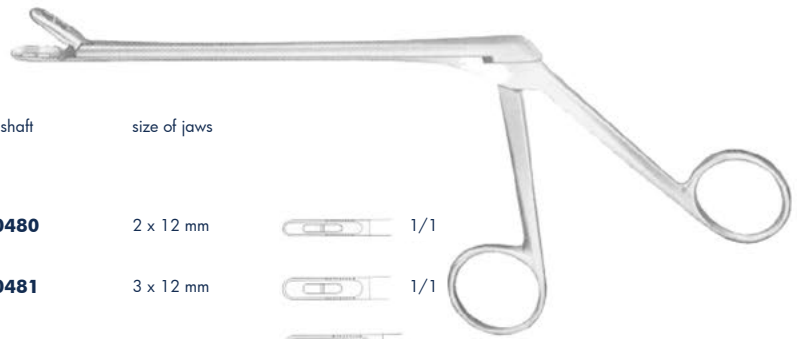

OSI210472

OSI210475

OSI210480

2 x 12 mm



1/1

OSI210473

OSI210476

OSI210481

3 x 12 mm



1/1

OSI210474

OSI210477

OSI210482

4 x 12 mm



1/1

OSI210478

OSI210483

5 x 12 mm



1/1

OSI210479

OSI210484

6 x 12 mm



1/1

150°

CASPAR

length of shaft
140 mm

length of shaft
160 mm

length of shaft
185 mm

size of jaws



OSI210485

OSI210487

OSI210490

3 x 12 mm



1/1

OSI210486

OSI210488

OSI210491

4 x 12 mm



1/1

OSI210489

OSI210492

5 x 12 mm



1/1

150°

lower part of jaw movable

CASPAR

length of shaft
140 mm

length of shaft
160 mm

length of shaft
185 mm

size of jaws



OSI210493

OSI210495

OSI210497

3 x 12 mm



1/1

OSI210494

OSI210496

OSI210498

4 x 12 mm



1/1

Rongeurs

CUSHING

OSI210254 2 x 10 mm



LOVE-GRUENWALD

OSI210263 3 x 10 mm



SPURLING

OSI210272 4 x 10 mm



150°

LOVE-GRUENWALD

OSI210266 3 x 10 mm



SPURLING

OSI210275 4 x 10 mm

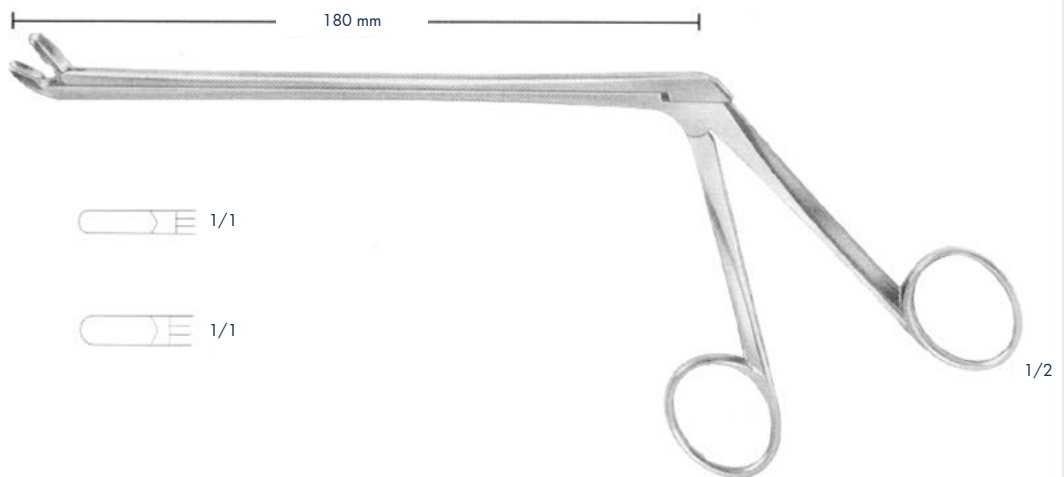

150°

upper part of jaw movable

LOVE-GRUENWALD

OSI210269 3 x 10 mm



LOVE-GRUENWALD

OSI210278 4 x 10 mm



Rongeurs

OLDBERG
OSI210279 Ø 7 mm

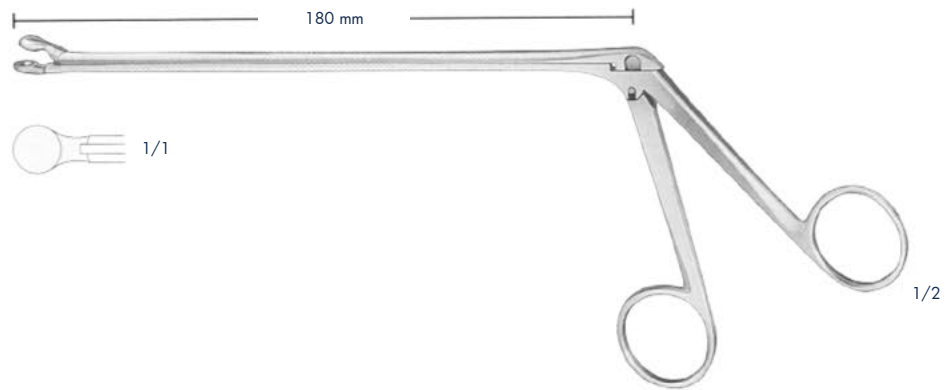

YASARGIL
OSI210499 Ø 2,2 mm



YASARGIL
OSI210280 Ø 3,5 mm



LANDOLT
OSI210281 Ø 9 mm
Tumor grasping forceps, blunt

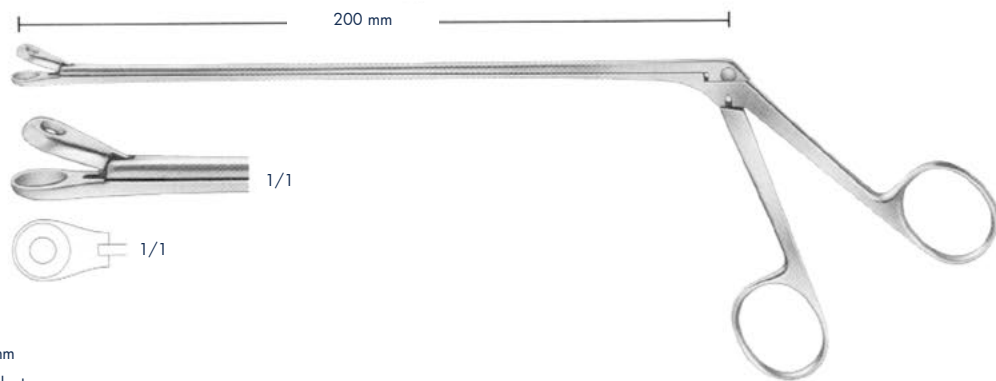

KRAMER
OSI210500 2,5 x 10 mm
Rongeur with depth guard

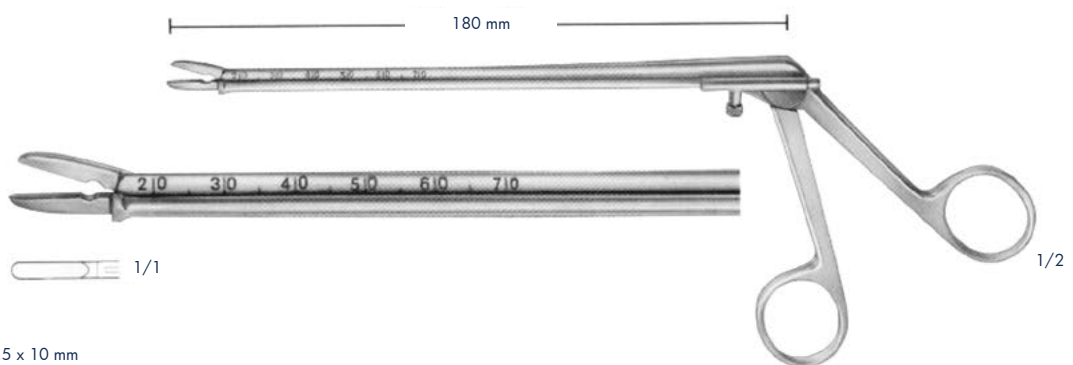

Rongeurs

CASPAR

OSI210501 3 mm

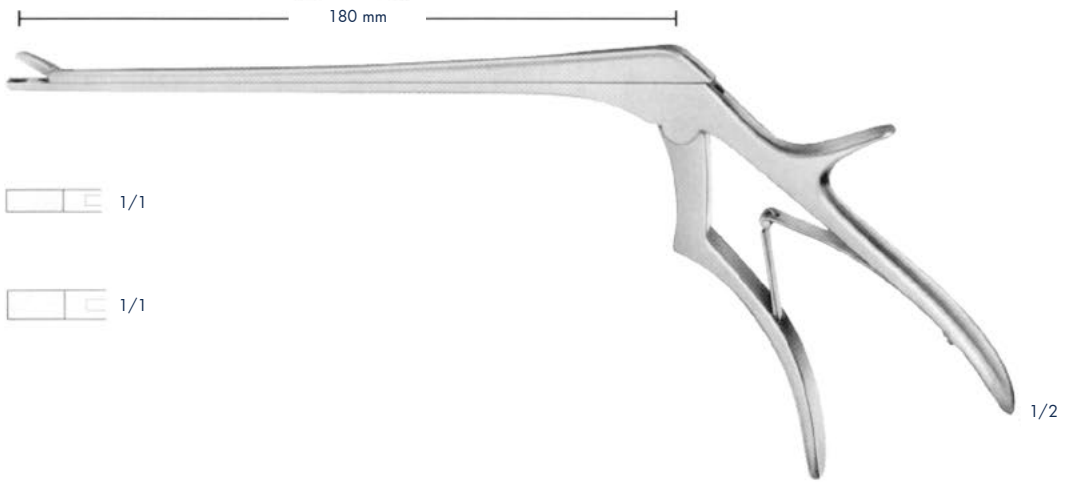
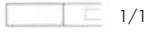

CASPAR

OSI210502 4 mm



CASPAR

OSI210503 4 mm

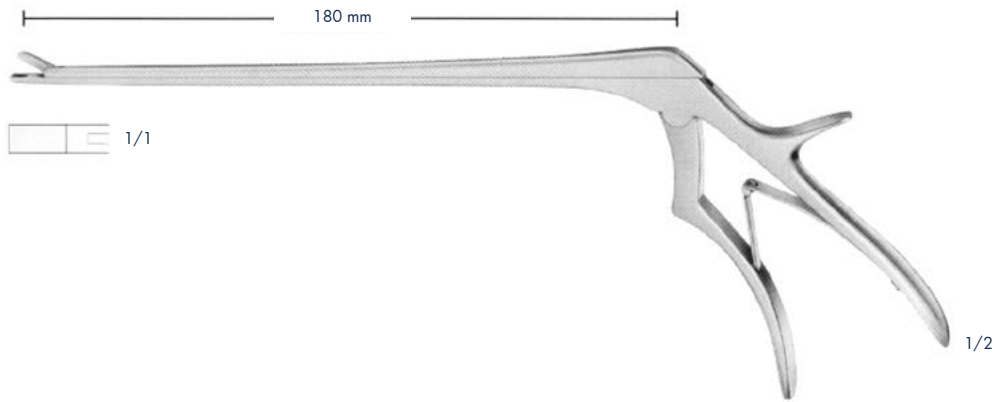

WAGNER

OSI210504 5,5 mm

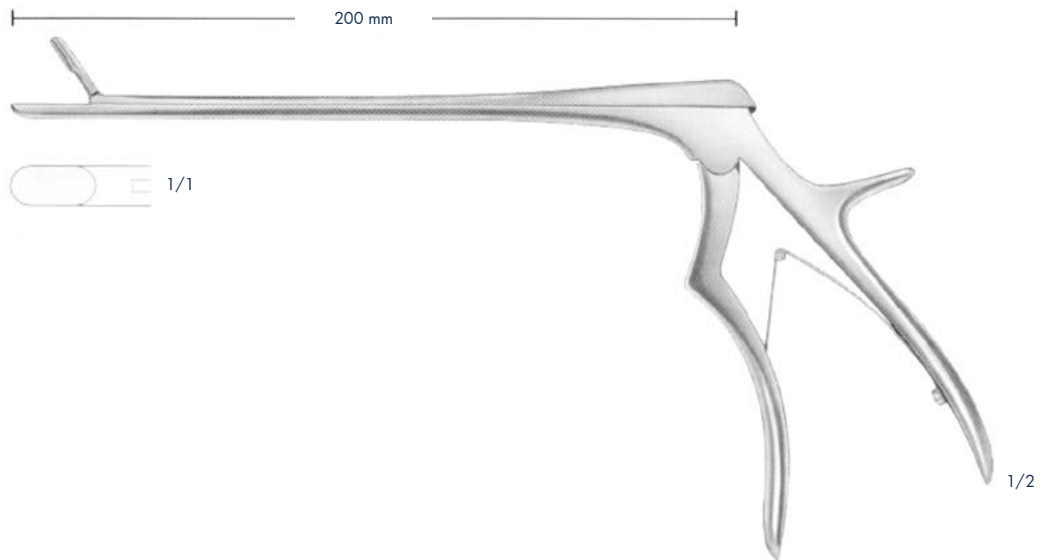

Rongeurs

WAGNER

OSI210505 5,5 mm

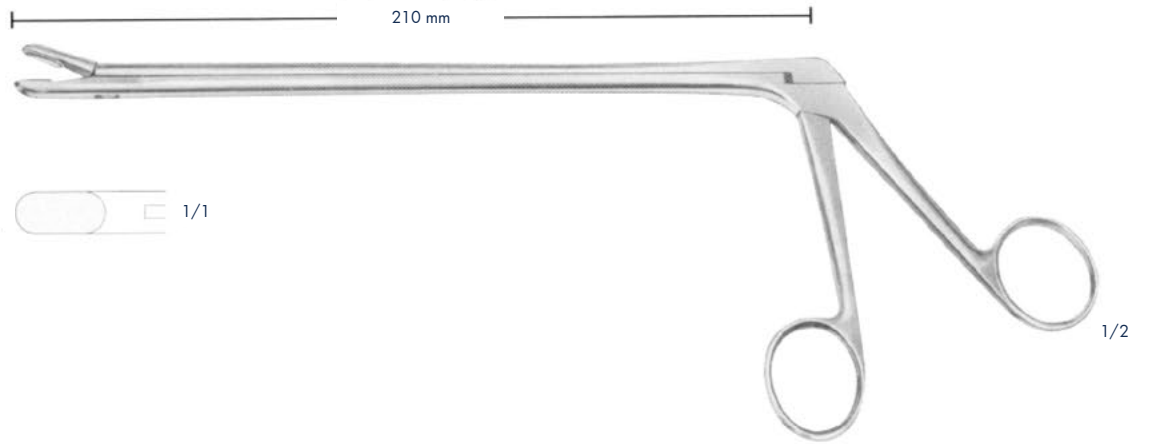

OSI210506 5,3 mm

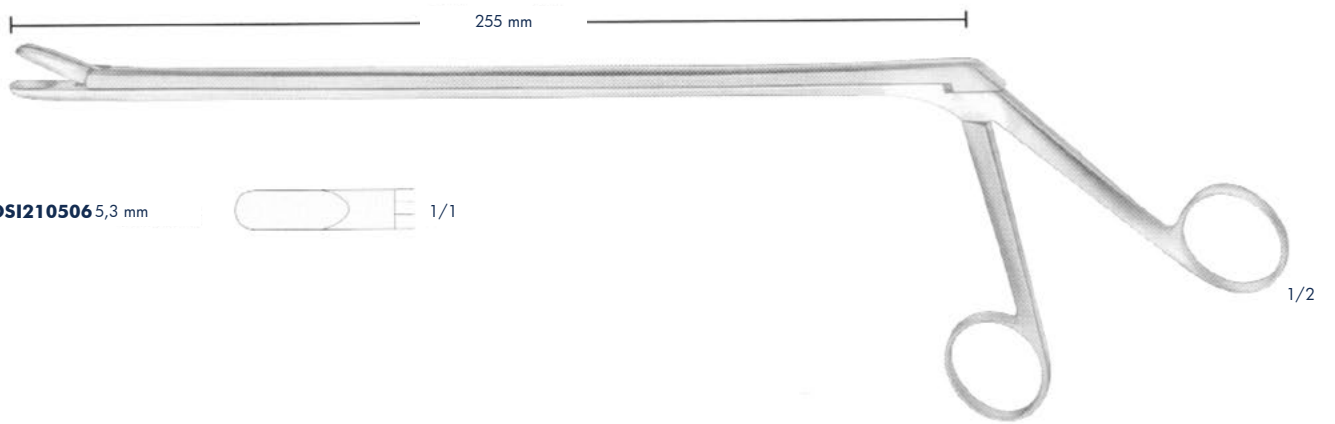

150°

SYPERT

OSI210507 5,8 mm

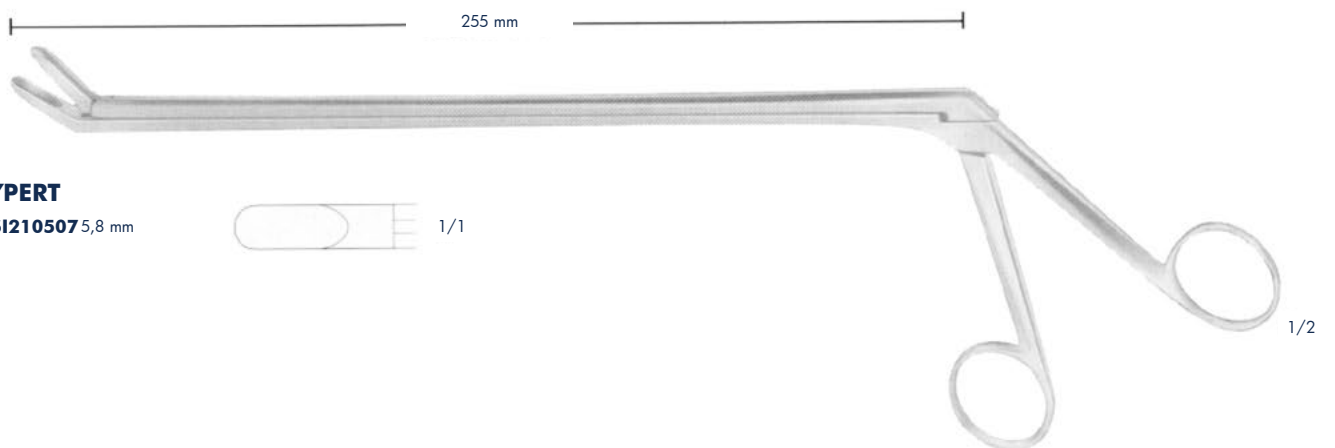

Amputation Knives



LISTON

- OSI100268** 130 mm
 - OSI100269** 160 mm
 - OSI100270** 190 mm
 - OSI100271** 220 mm
- Length of blade



double cutting

CATLIN

- OSI100272** 160 mm
- Length of blade

1/2



LANGENBECK

- OSI100273** 120 mm
- Length of blade
Flap knife

1/2

Amputation- and Resection Knives



1/2

OSI100274

105 mm
Length of blade
Phalangeal knife



1/2

OSI100275

110 mm
Length of blade
Interosseous knife

double cutting



1/2

OSI100276

65 mm
Length of blade
Periosteum knife
with raspatory



1/2

LANGENBECK

OSI100277 - OSI100278

55 mm
Length of blade
Resection knives



OSI100277



1/1

OSI100278

Amputation Retractors

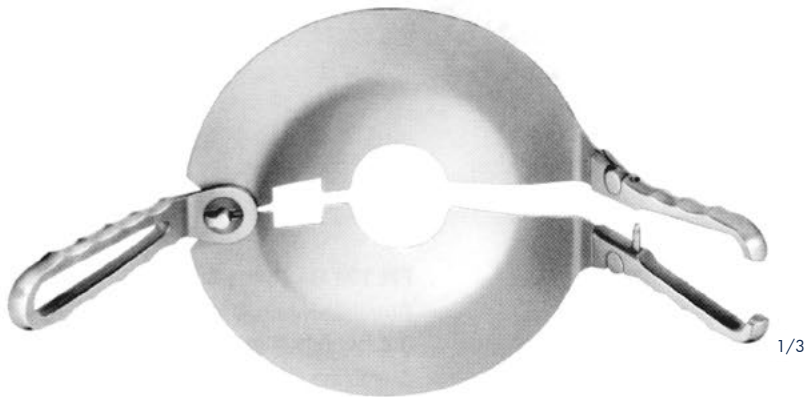

PERCY
OS1190540
removable handles

1/3

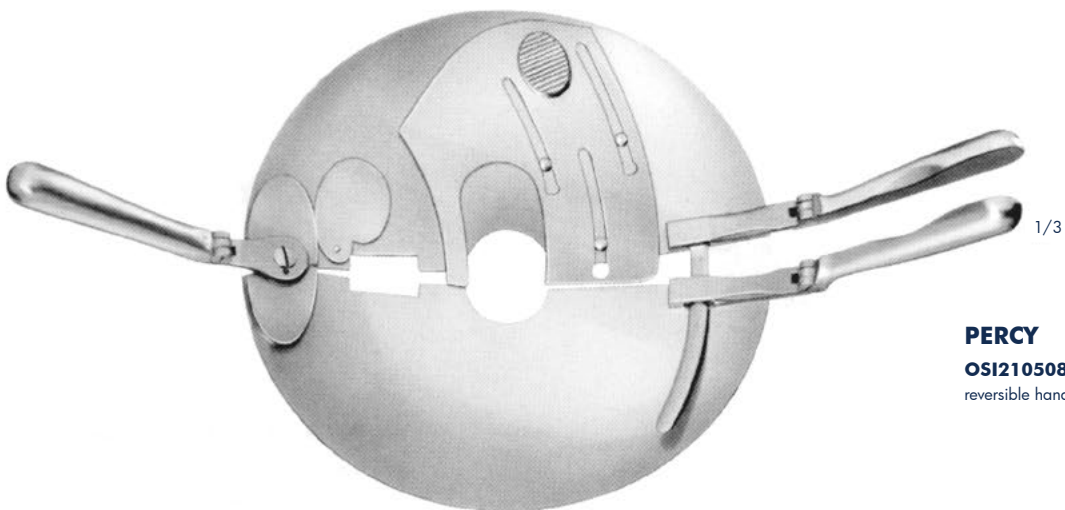

PERCY
OS1210508
reversible handles

1/3

Amputation Saws



CHARRIERE

OSI180116

350 mm

Length of blade } 215 mm

complete with one saw blade
each OSI180114 12 mm and OSI180115 18 mm

Spare saw blades, carbon steel

OSI180114 12 mm

OSI180115 18 mm



RUST

OSI210991

390 mm

Length of blade } 235 mm

complete with one saw blade
each OSI210510 6 mm, OSI210511 8 mm and
2 saw blades OSI210512 12 mm

OSI210509

Bow only

Spare saw blades, carbon steel

OSI210510 6 mm

OSI210511 8 mm

OSI210512 12 mm

OSI210513 18 mm

Amputation Saws



BIER

OSI210514

420 mm

Length of blade

} 270 mm

complete with one saw blade
each OSI210515 4 mm, OSI210516 6 mm
and OSI210517 8 mm

Spare saw blades, carbon steel

OSI210515 4 mm

OSI210516 6 mm

OSI210517 8 mm

CHARRIERE

OSI210518

270 mm

Length of blade

184 mm

Spare saw blade,
carbon steel

OSI210519

CHARRIERE

OSI210520

340 mm

Length of blade

255 mm

Spare saw blade,
carbon steel

OSI210521

SATTERLEE

OSI180120

290 mm

Length of blade

200 mm

Spare saw blade

OSI210517

LANGENBECK

OSI210522

235 mm

Length of blade

115 mm

Metacarpal saw

Wire Saws and Conductor



OLIVECRONA

- OSI210101** 300 mm
- OSI210102** 400 mm
- OSI210103** 500 mm
- OSI210104** 700 mm

Sales unit :
PA = Package of 5 pieces

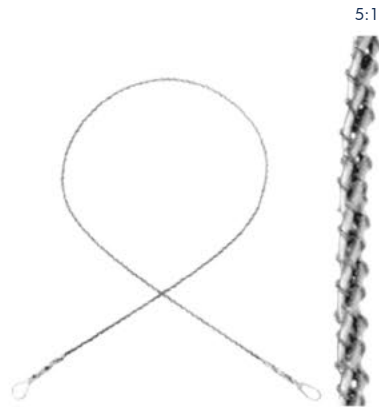

GIGLI

- OSI210304** 300 mm
- OSI210305** 400 mm
- OSI210306** 500 mm

fine, 6 wires twisted

- OSI210632** 500 mm

grob, 4-teilig

coarse, 4 wires twisted

Sales unit : PA = Package of 5 pieces



GIGLI

- OSI210106**
Handle



LEBSCH

OSI210307

Conductor for GIGLI and OLIVECRONA wire saws, malleable
250 mm

1/2

Elevators and Bone Levers

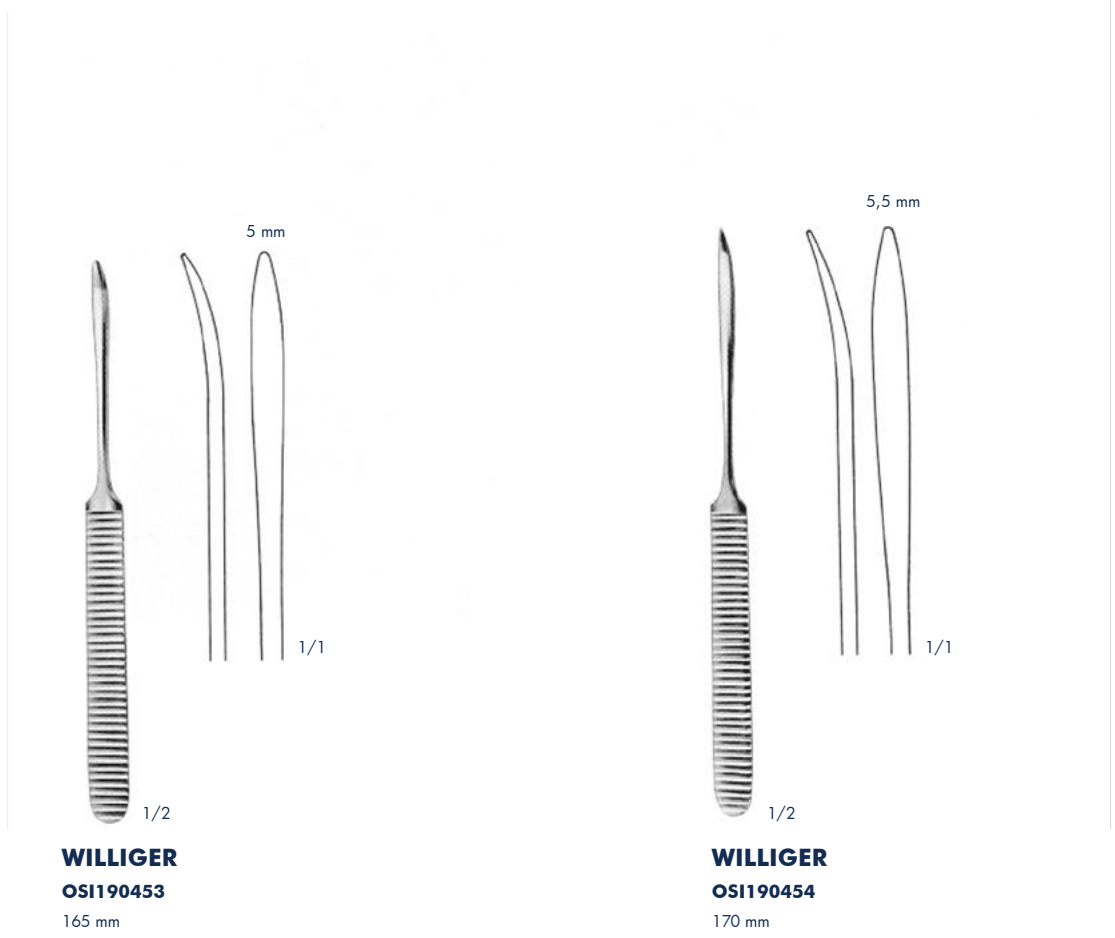
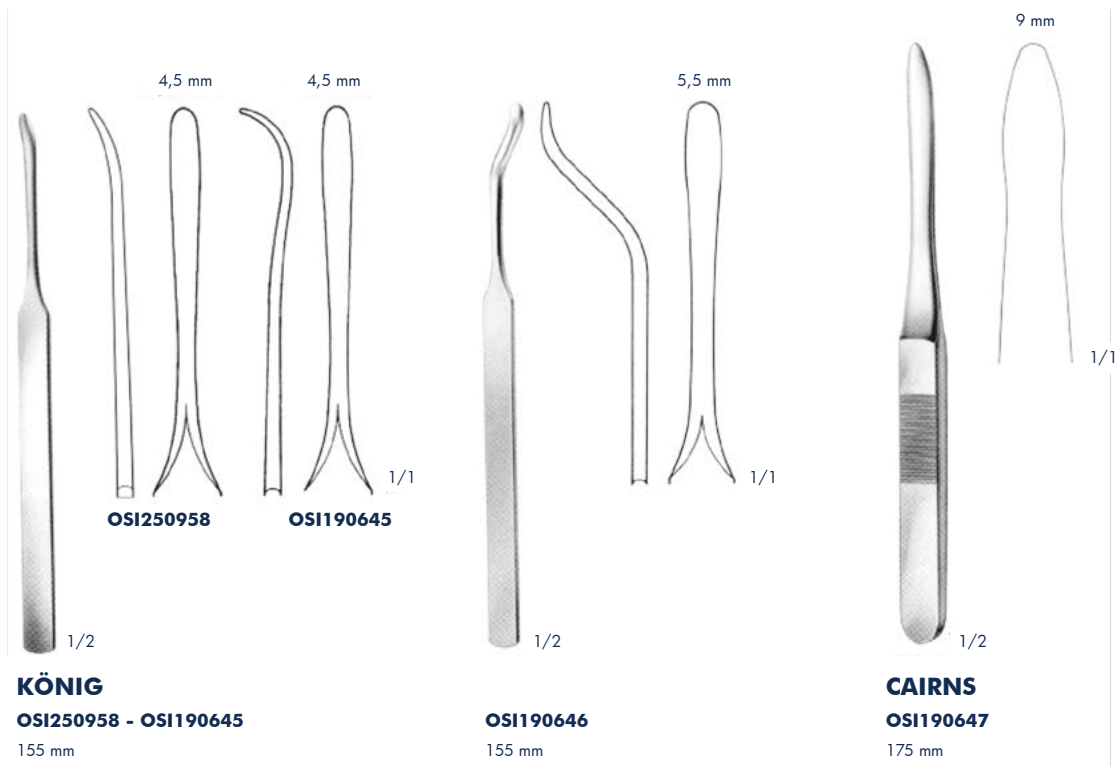

Elevators and Bone Levers

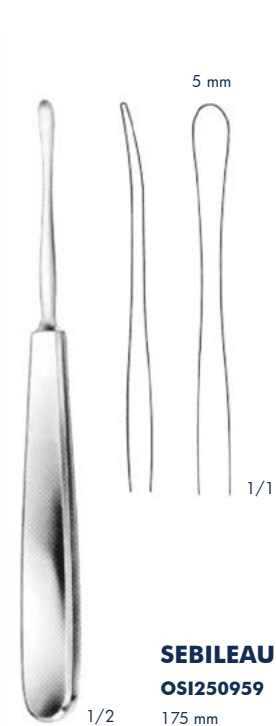

SEBILEAU
OS1250959
175 mm



QUERVAIN
OS1250960
195 mm



LANGENBECK
OS1190451 - OS1190452
195 mm

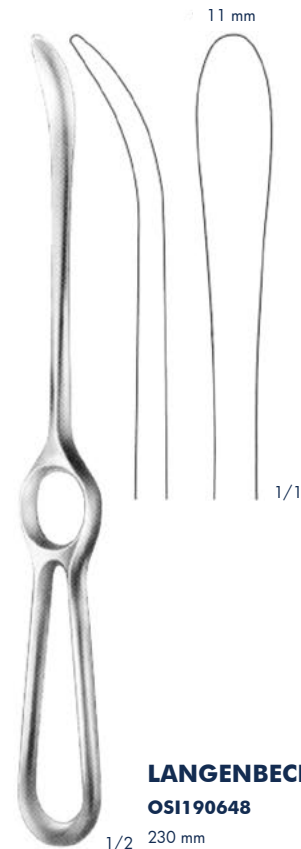

LANGENBECK
OS1190648
230 mm

Bone Levers



OSI190649
140 mm



OSI190650
150 mm

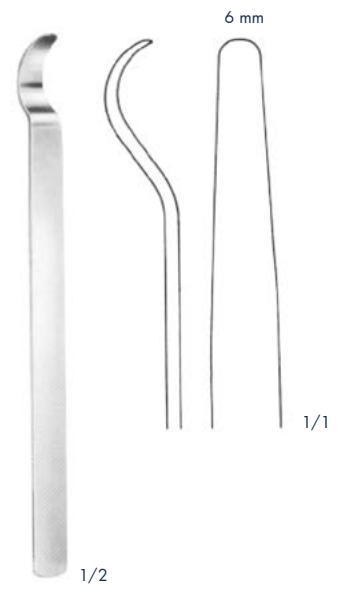

OSI190465
150 mm



BUCK-GRAMCKO
OSI190651
150 mm

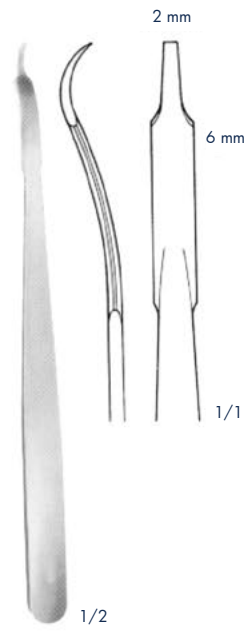

OSI190466
160 mm

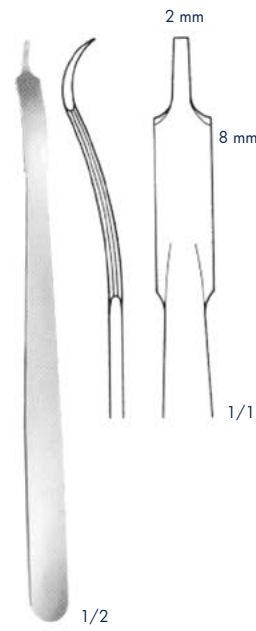

OSI190467
160 mm

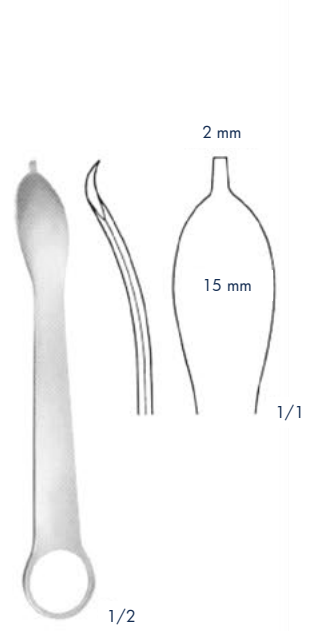

OSI190469
125 mm

Bone Levers

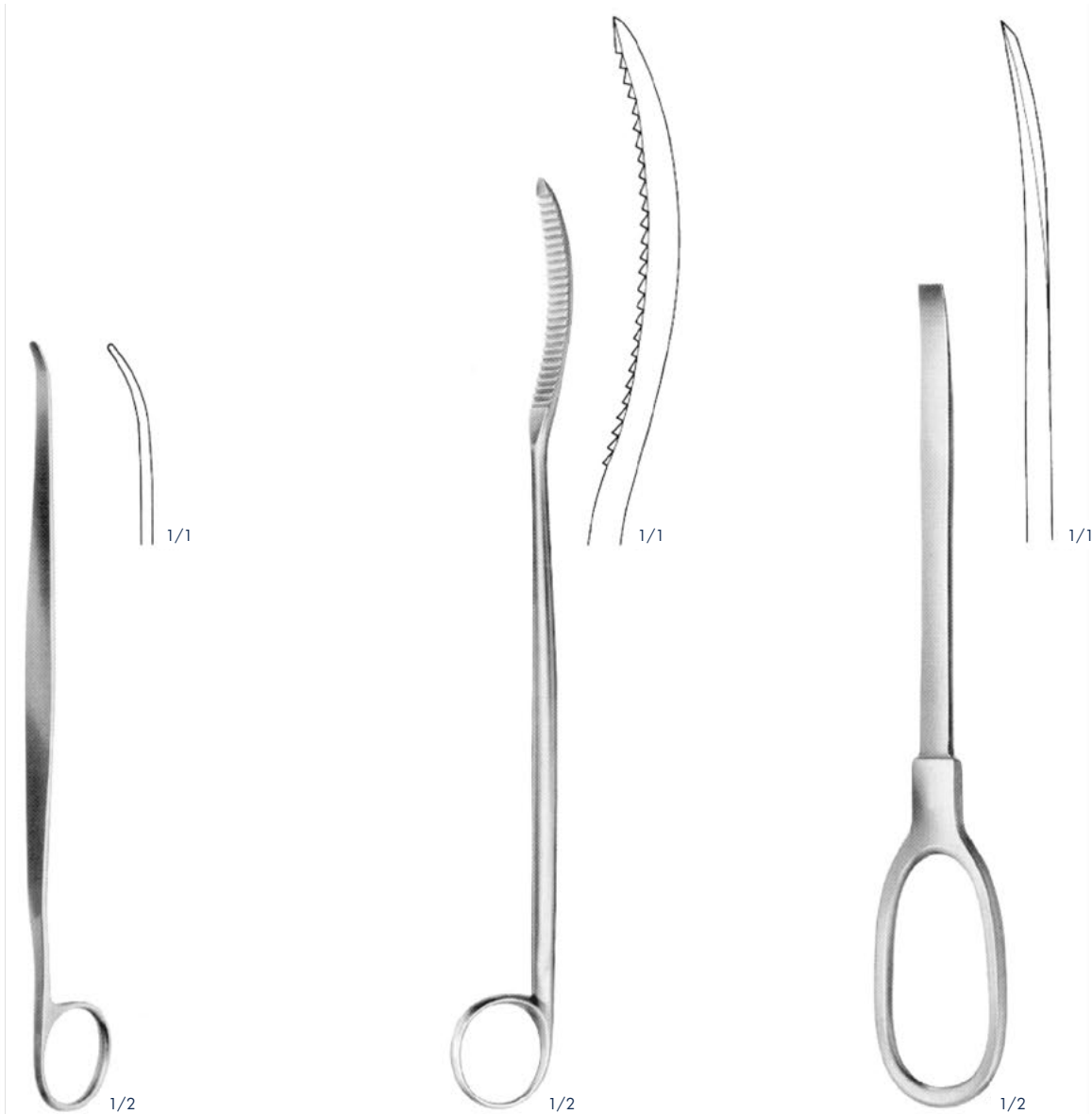

LANE TRETHOWAN
OSI190652
215 mm

LANE
OSI190653
255 mm

BRISTOW
OSI190654
230 mm

Bone Levers

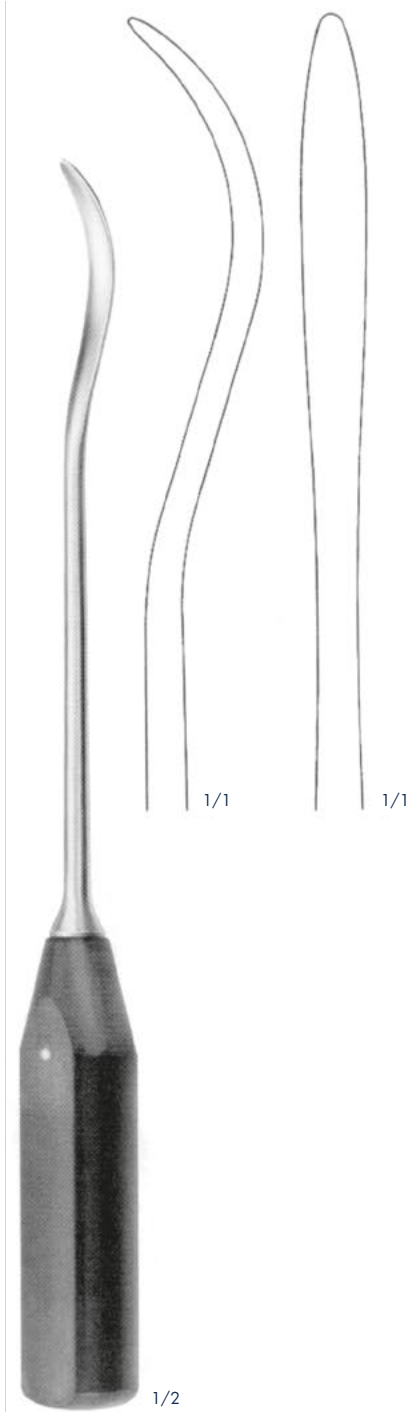

WAGNER
OSI190655
330 mm



WATSON-JONES
OSI190656
280 mm

Bone Levers

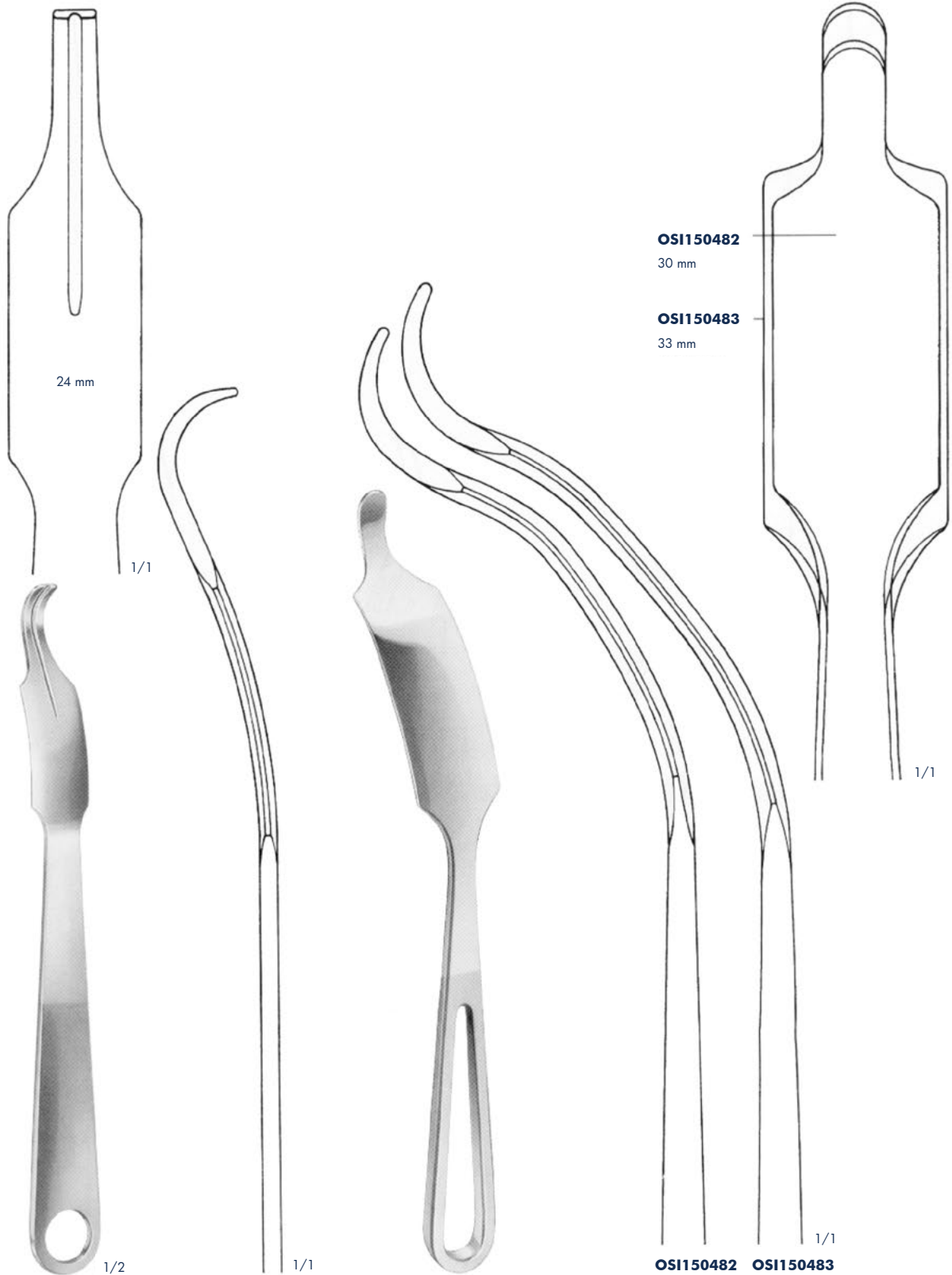

LANGE-HOHMANN
OSI150481
 250 mm

LANGE-HOHMANN modif.
OSI150482 265 mm
OSI150483 280 mm

OSI150482 30 mm
OSI150483 33 mm

Bone Levers

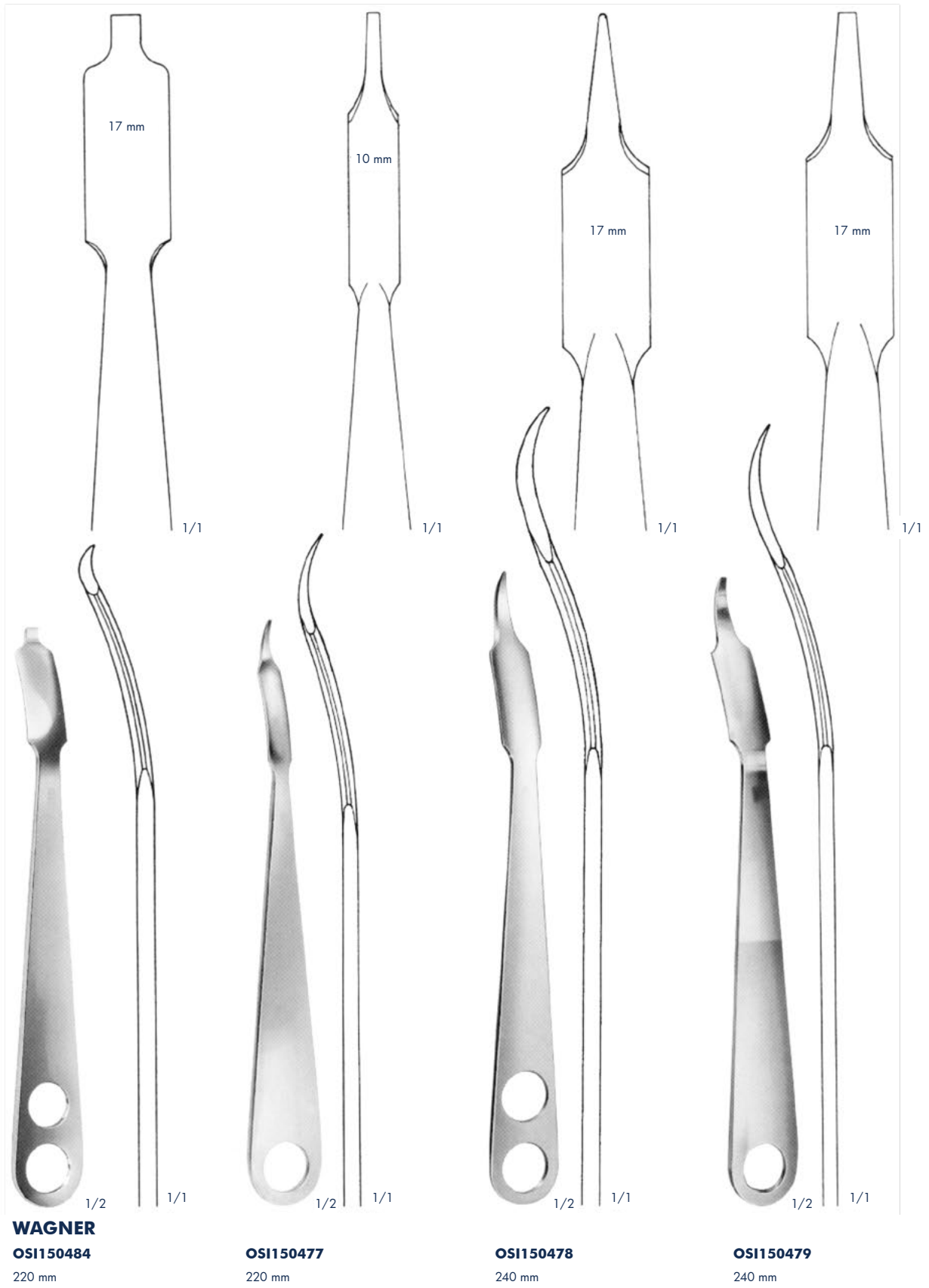

Bone Levers

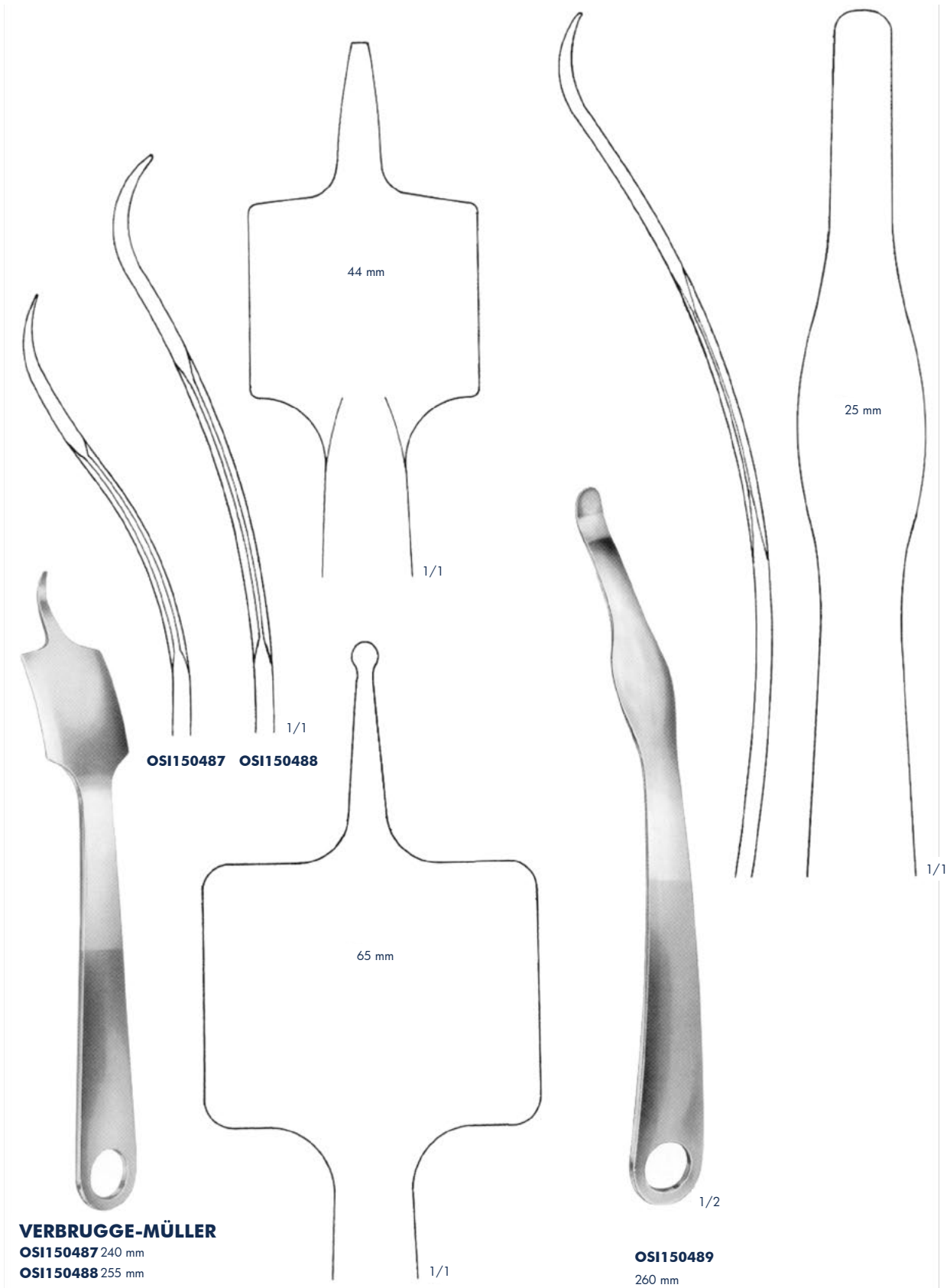

Bone Levers

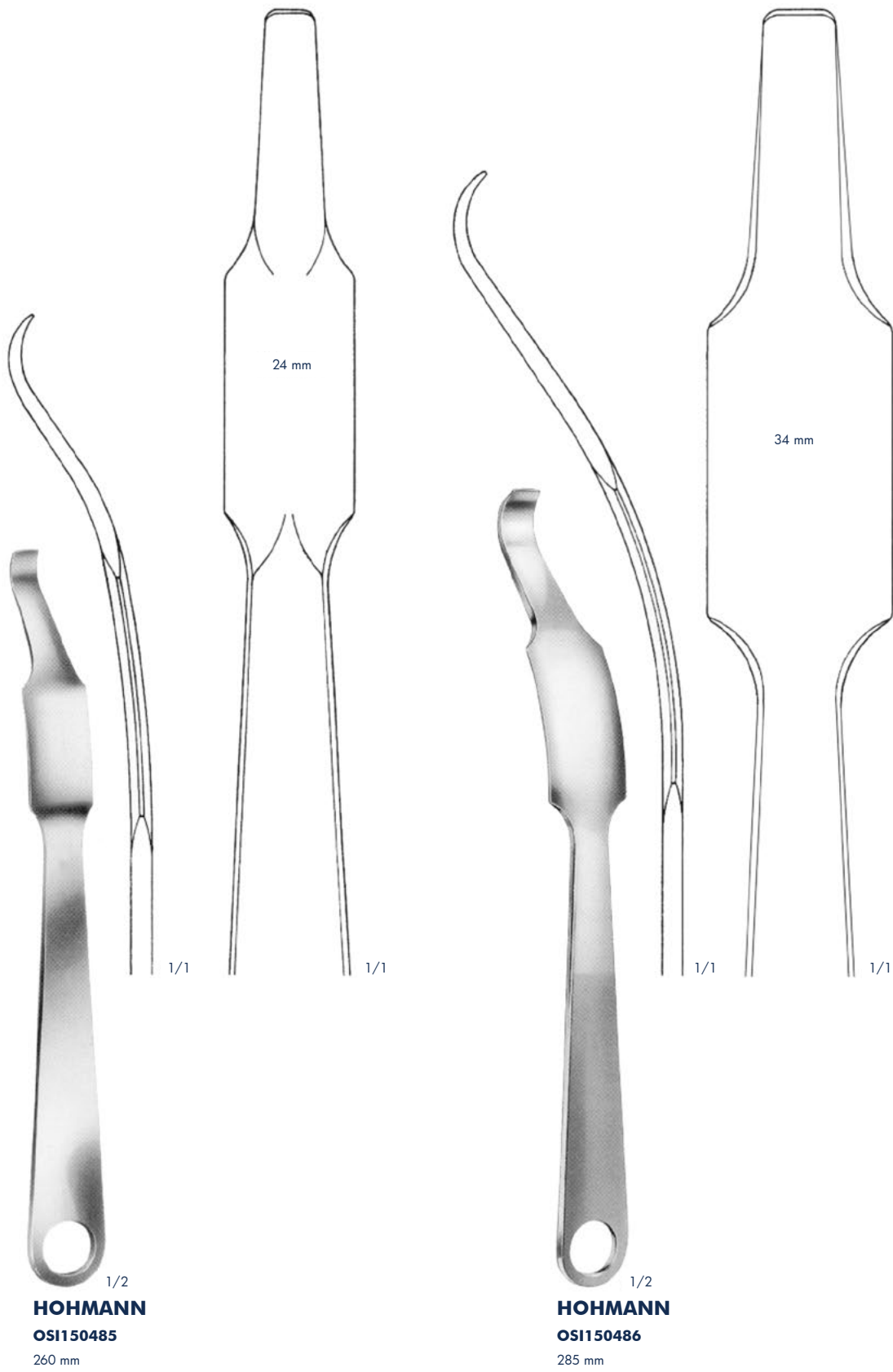

Bone Levers

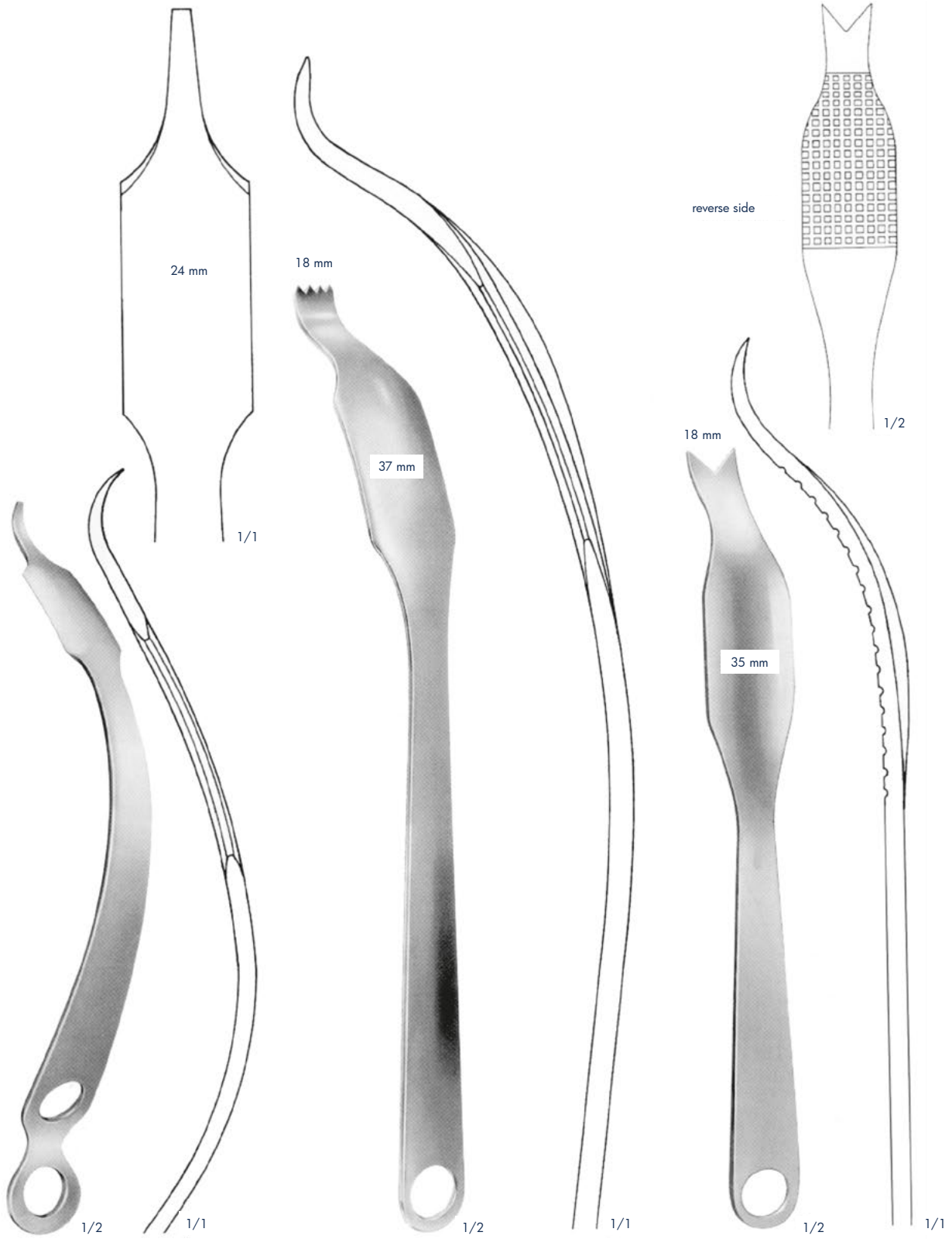

HOHMANN-ALDINGER
OSI150480
 270 mm

Schumacher mod. WAGNER
OSI190657
 345 mm

SCHUMACHER
OSI190658
 290 mm

Special Bone Levers

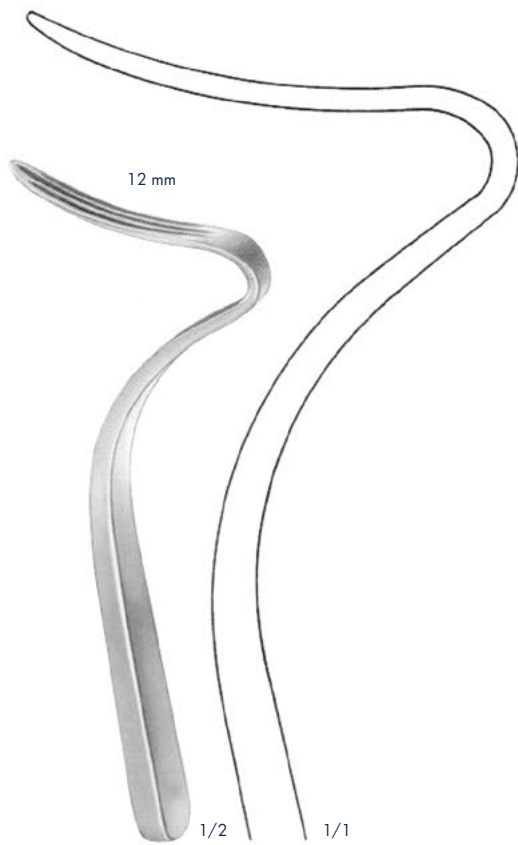

TAGER
OSI190659
 Bone lever for angle joint operations
 175 mm

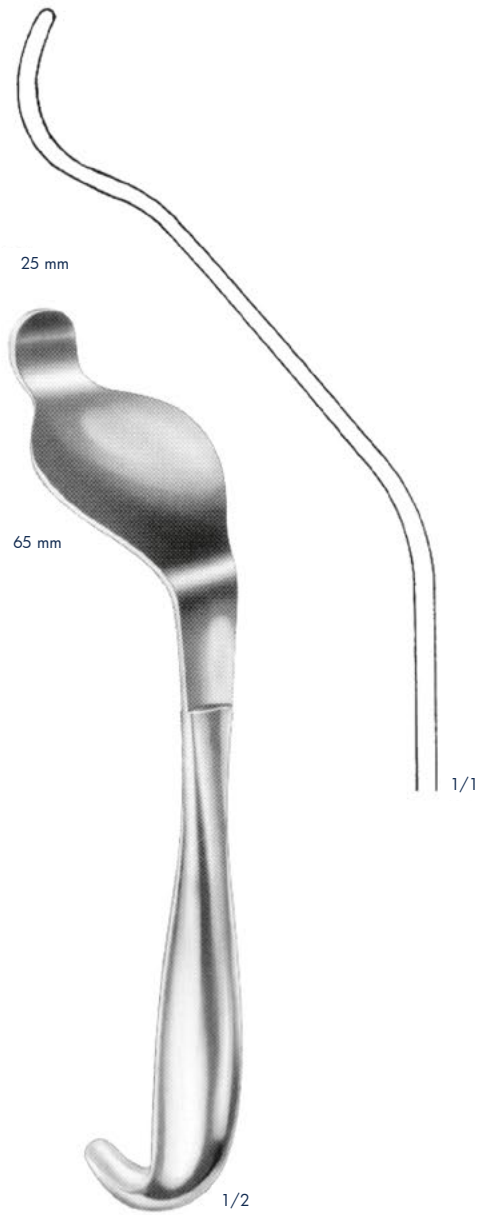

BENNETT
OSI190470
 235 mm

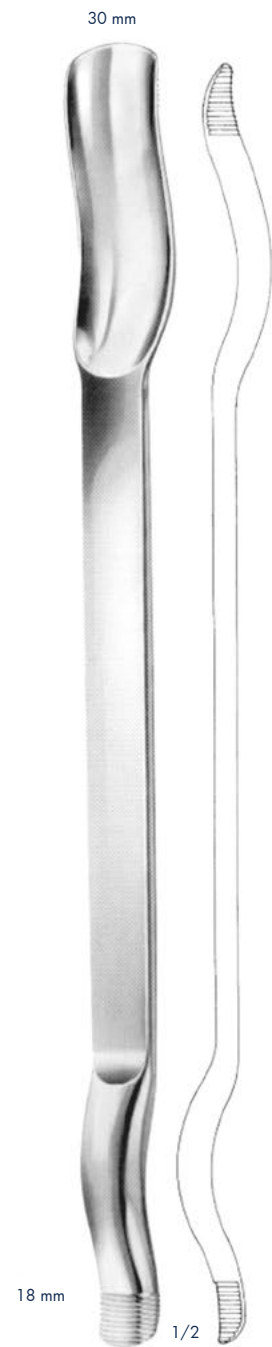

MURPHY-LANE
OSI190660
 Luxation lever
 340 mm

Raspatories



PARTSCH
OSI190661 - OSI190662
150 mm

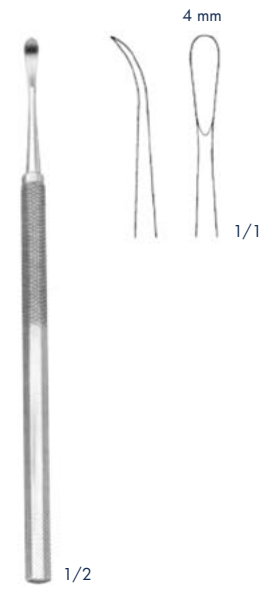

PARTSCH mod. LANGE
OSI190663
145 mm

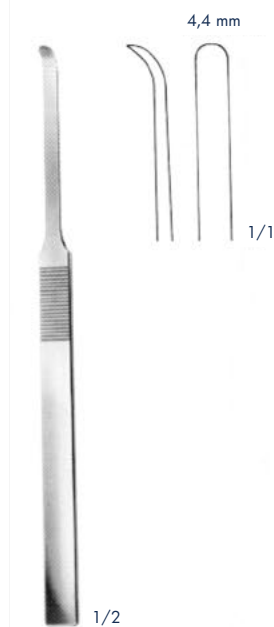

MC KENTY
OSI250525
155 mm

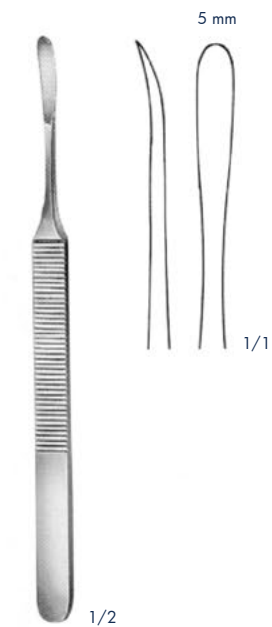

KÖNIG
OSI190664
155 mm

Raspatories

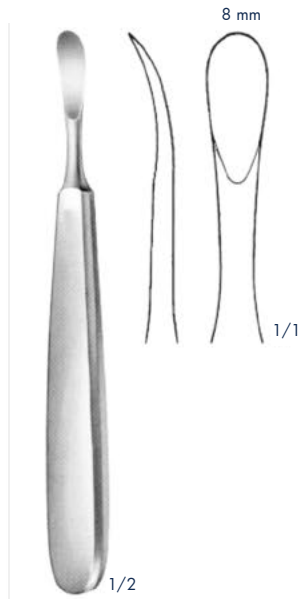

TRELAT
OSI190665
 150 mm



OSI190666 - OSI190667
 140 mm



WILLIGER
OSI190427
 140 mm



WILLIGER
OSI190428 - OSI190668
 160 mm



WARD
OSI190669
 170 mm

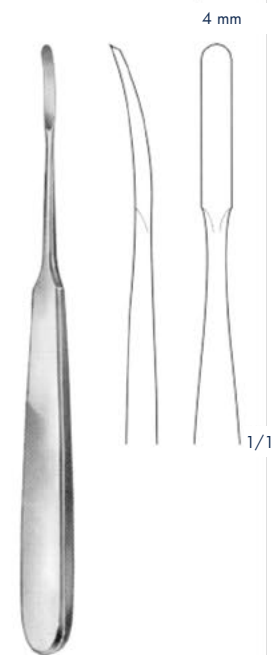

JOSEPH
OSI190670
 160 mm

Raspatories



LEMPERT
OSI190671
narrow
165 mm

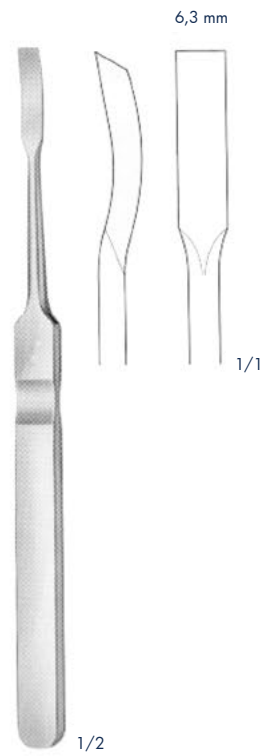

LEMPERT
OSI250961
broad
185 mm

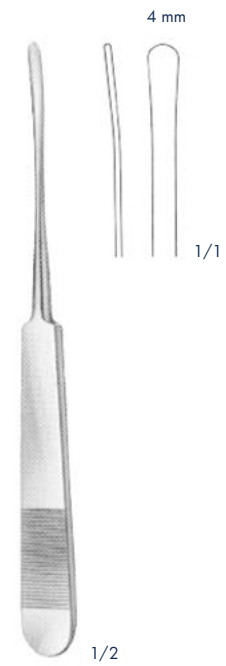

ST CLAIR THOMPSON
OSI190672 sharp
OSI190673 blunt
160 mm

Raspatories

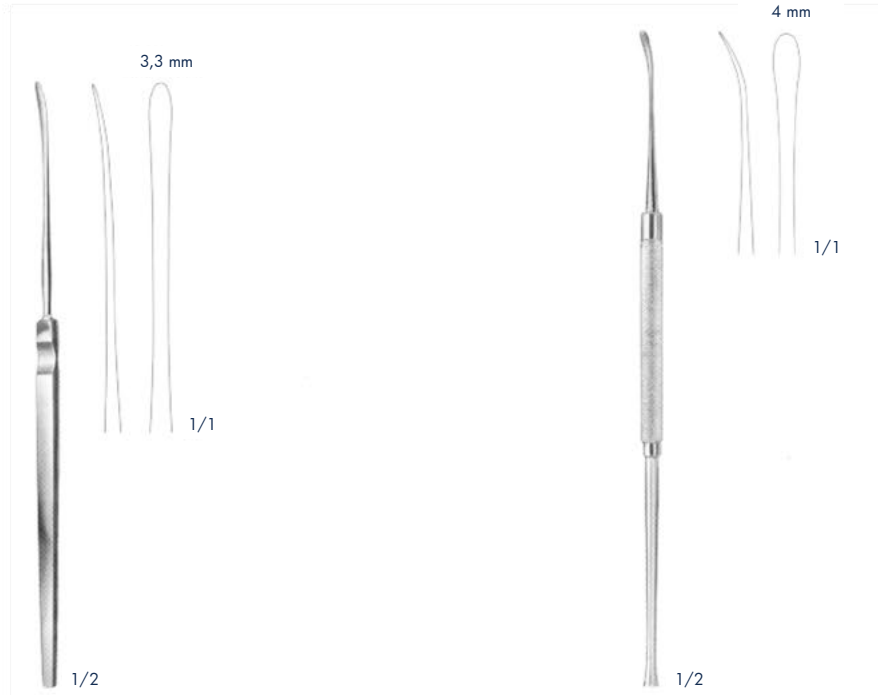

HALLE
OSI250527
blunt
180 mm

FREER
OSI250530
blunt
190 mm

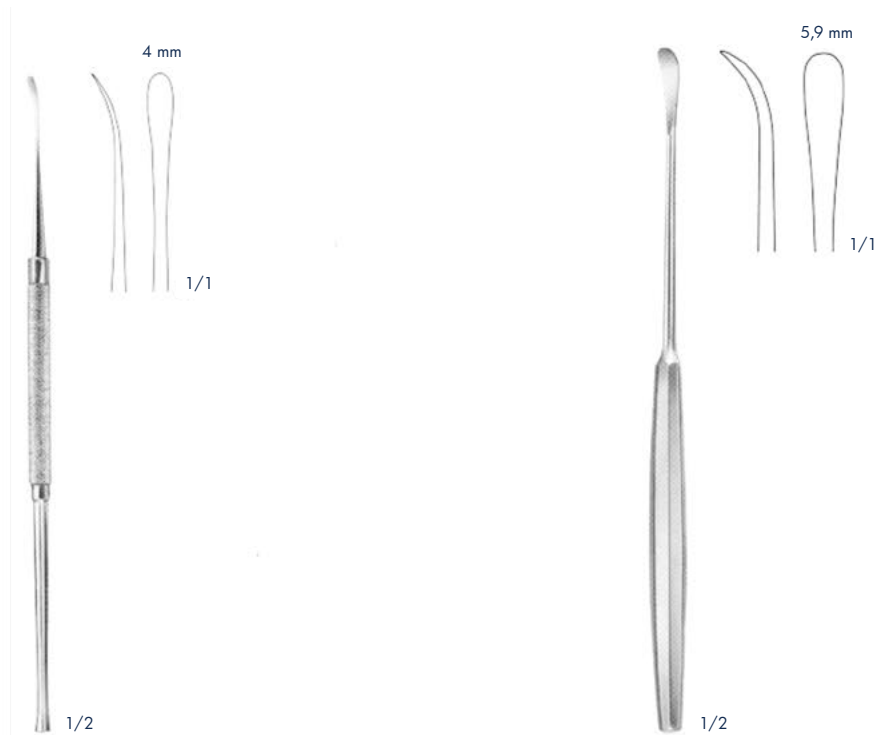

FREER
OSI250529
sharp
190 mm

SEWALL
OSI190674
blunt
200 mm

Raspatories

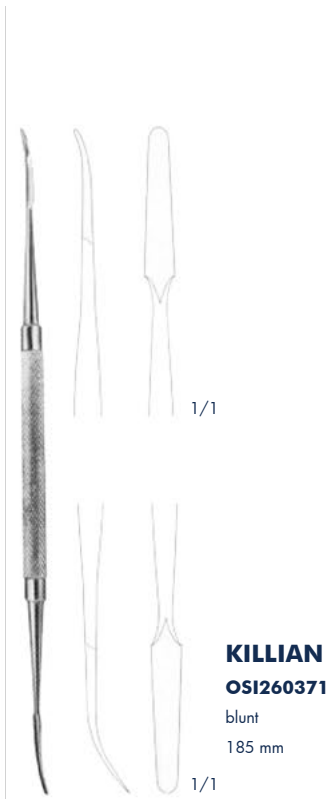

KILLIAN
OS1260371
blunt
185 mm

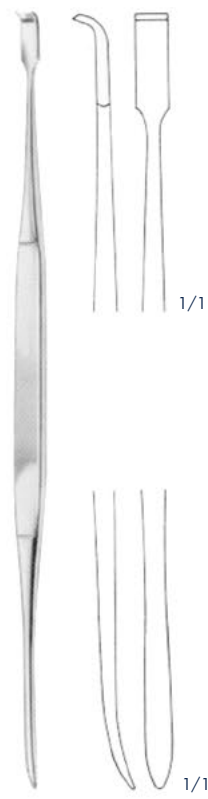

HOWARTH
OS1190675
blunt
215 mm

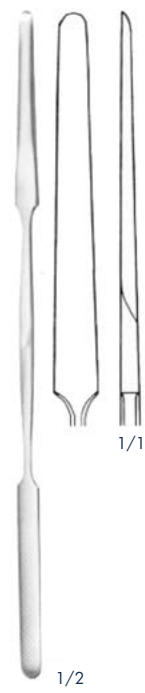

KILLIAN
OS1260373
blunt
185 mm

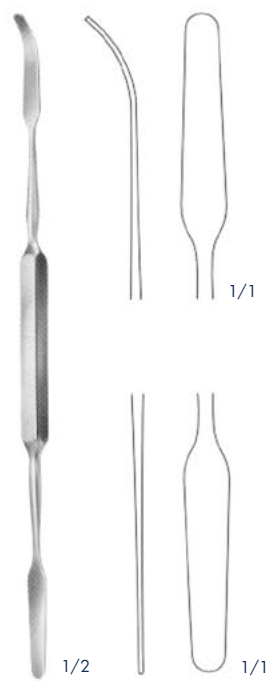

MAC DONALD
OS1190676
blunt
190 mm

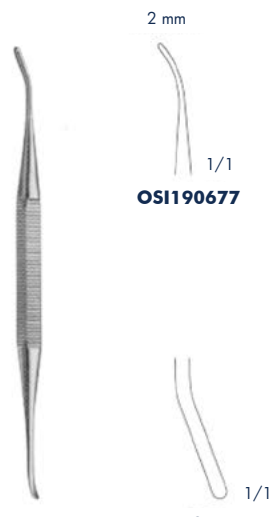

WATSON-CHEYNE
OS1190677 130 mm
OS1190678 190 mm

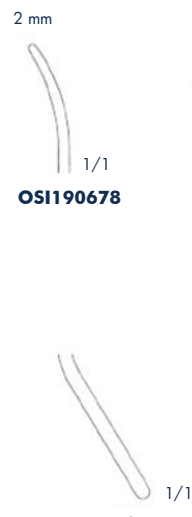

FREER
OS1190679
180 mm

Raspatories

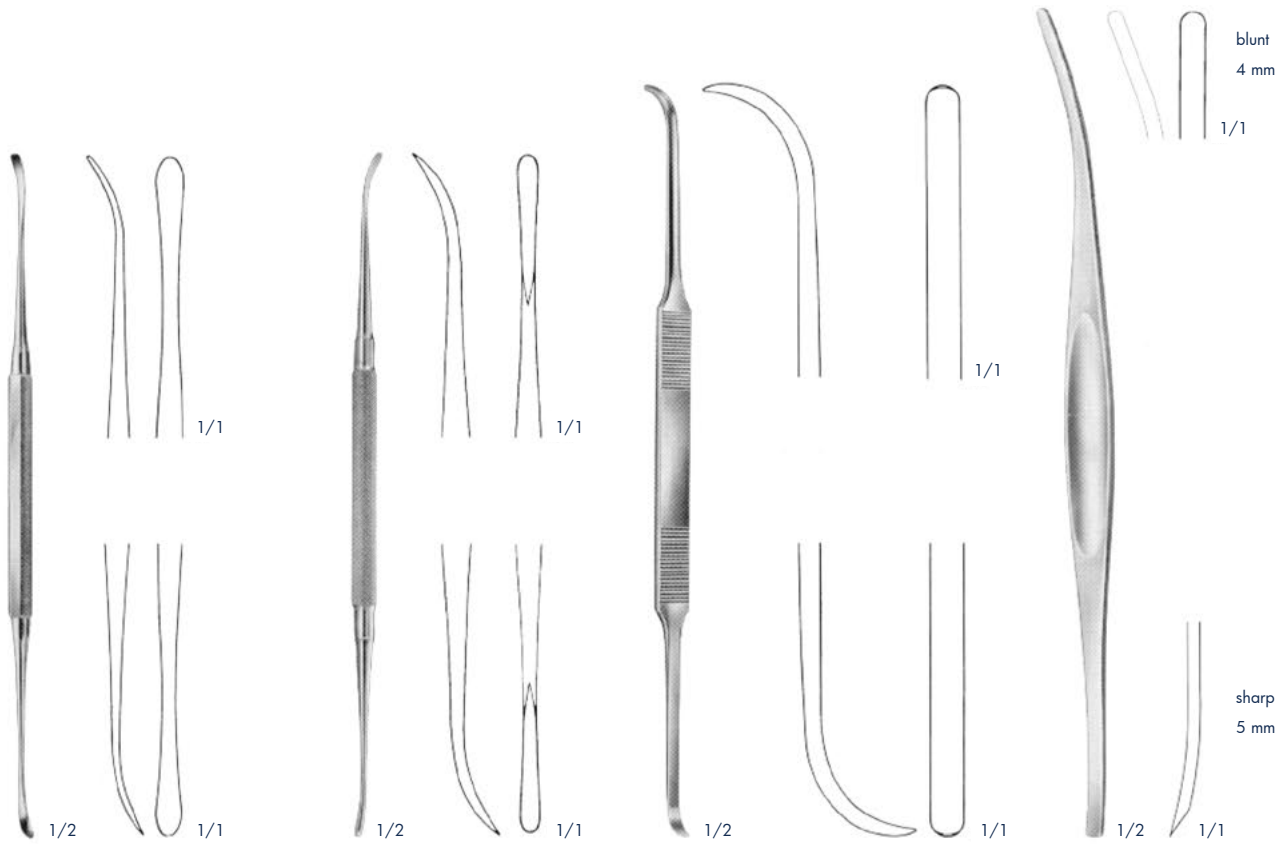

FREER
OSI260369
 blunt
 185 mm

FREER-YASARGIL
OSI260370
 sharp
 185 mm

COTTLE
OSI250534
 sharp
 200 mm

HILL
OSI190680
 blunt
 220 mm

Raspatories

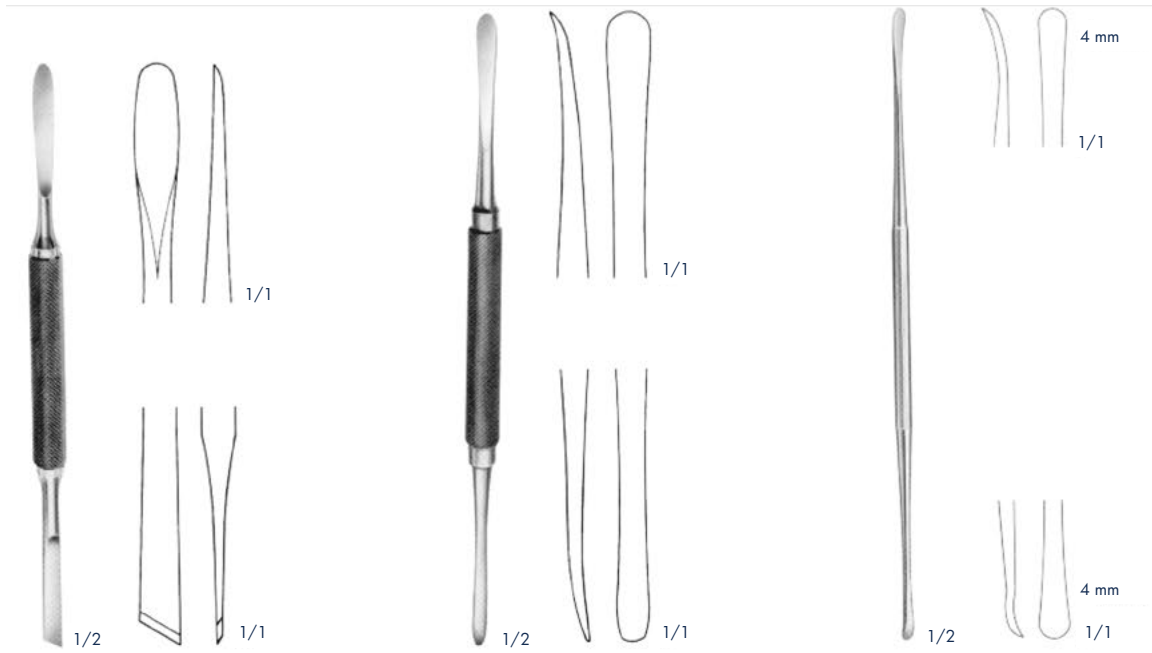

MEAD
OSI190681
 sharp
 165 mm

MOLT
OSI190682
 sharp
 180 mm

SYME
OSI190683
 sharp
 185 mm

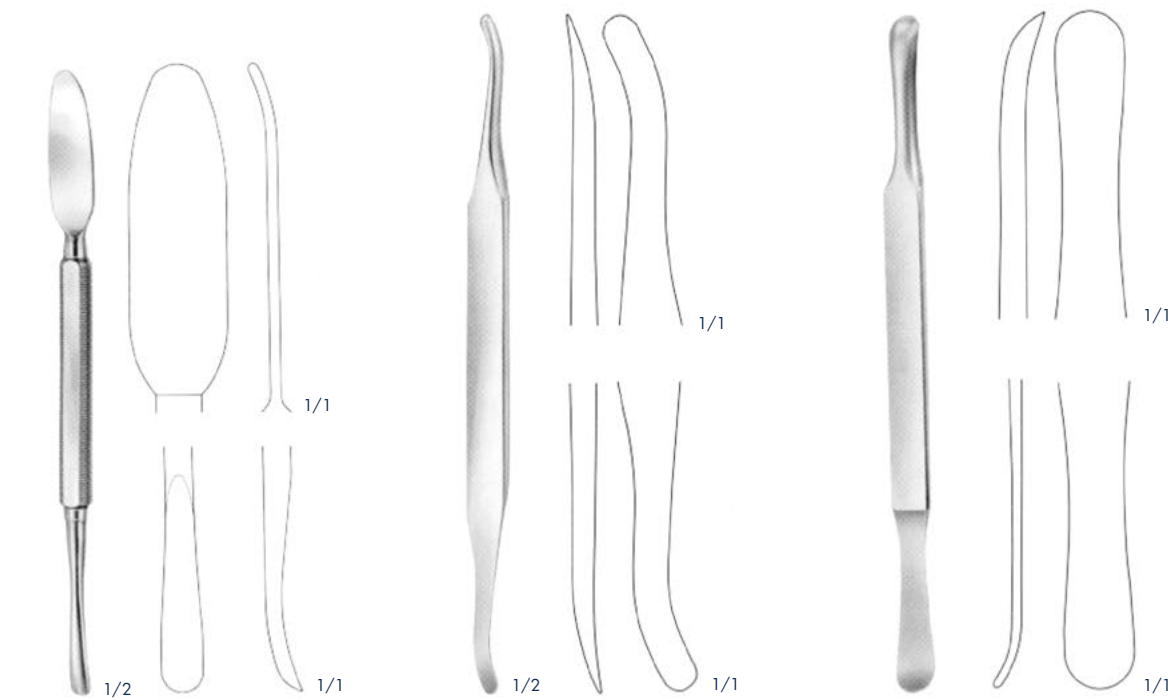

ROBERTS
OSI190684
 sharp
 185 mm

SELDIN
OSI190685
 195 mm

SYME
OSI190686
 195 mm

Raspatories



OSI190687
4 mm

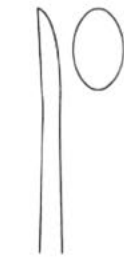

OSI190688
7 mm

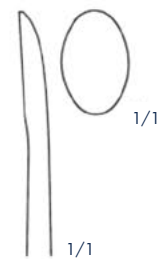

OSI190689
9 mm



OSI190692
3 mm



OSI190693
6 mm

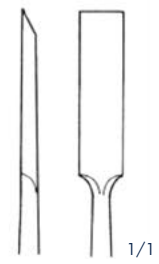

OSI190694
6 mm



OSI190690
6 mm

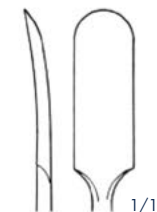

OSI190691
8 mm

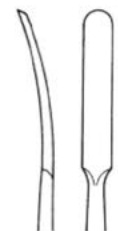

OSI190695
4 mm



OSI190696
5 mm

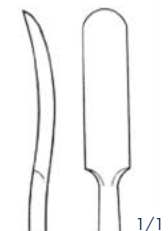

OSI190697
6 mm



OSI190698
4 mm
90°



OSI190699
6 mm
90°

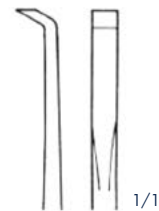

OSI190700
3,5 mm
45°



1/2

MANNERFELT, modif.
OSI190687 - OSI190700
155 mm

Raspatories

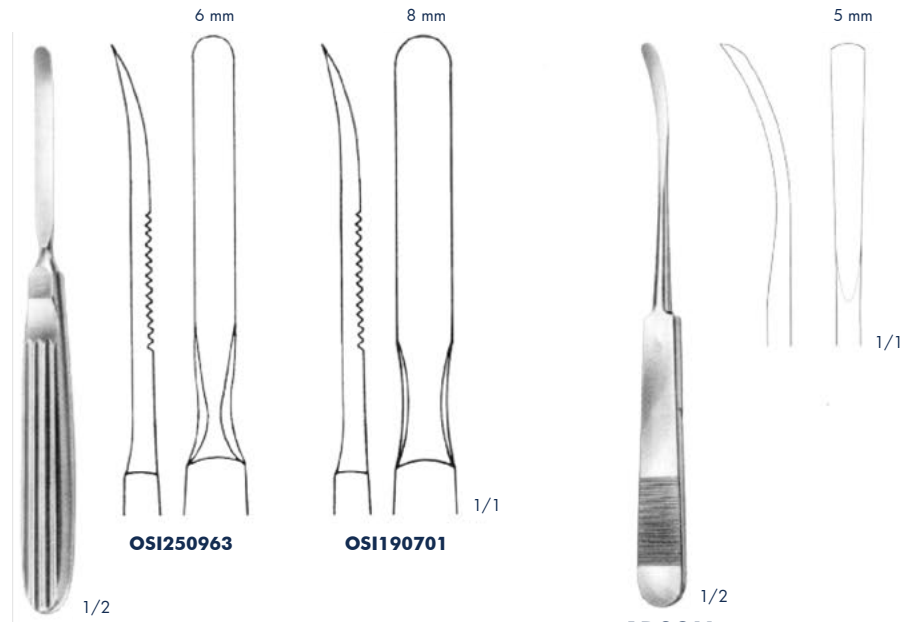

OSI250963 - OSI190701
165 mm

ADSON
OSI190702
165 mm



ADSON
OSI190447 - OSI190450
170 mm

Raspatories

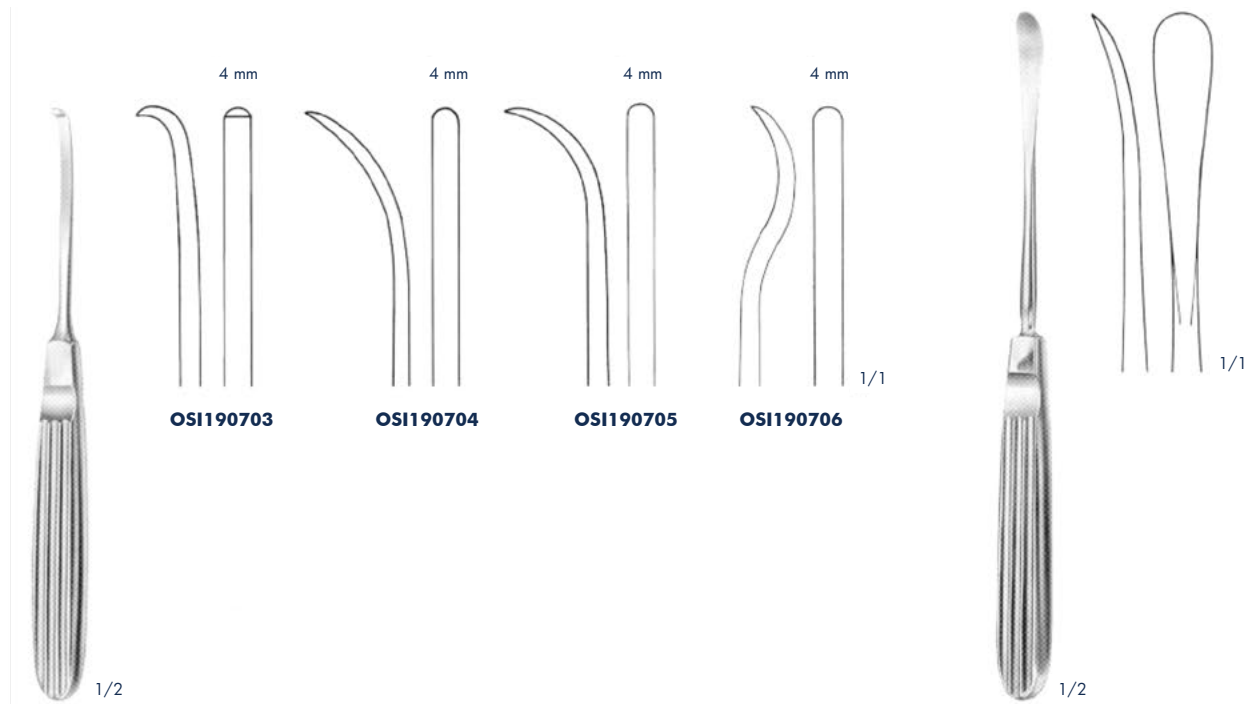

MÜHLING
OSI190703 - OSI190706
170 mm

COTTLE
OSI260403
195 mm

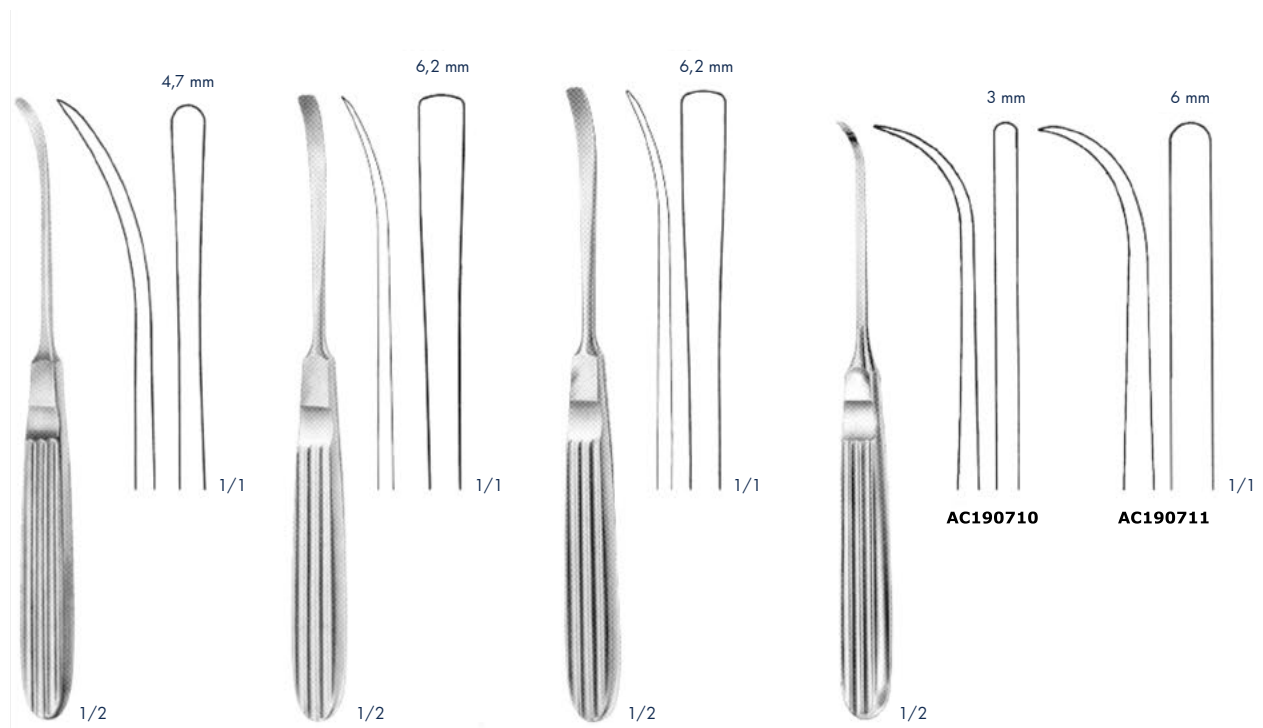

LANDOLT
OSI190707
175 mm

CASPAR
OSI190708
180 mm

CASPAR
OSI190709
180 mm

OSI190710 - OSI190711
170 mm

Raspatories with HARTPRESS - handle



OSI190712
190 mm



OSI190424
185 mm



OSI190425
190 mm

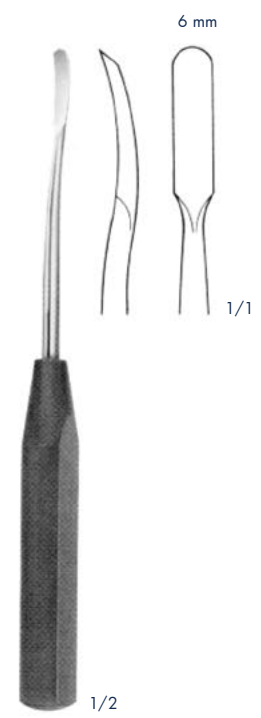

OSI190426
190 mm

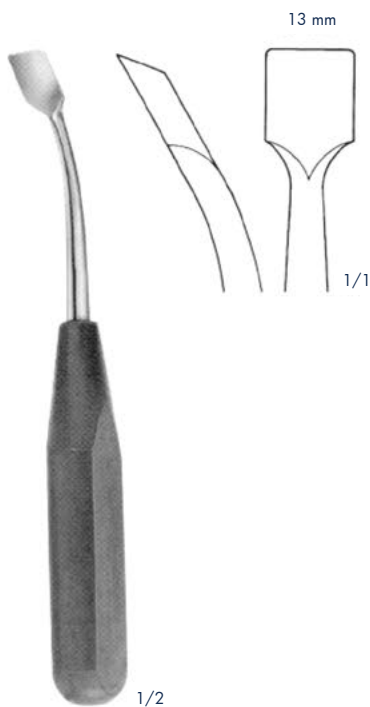

OSI190713
185 mm



OSI190421
195 mm

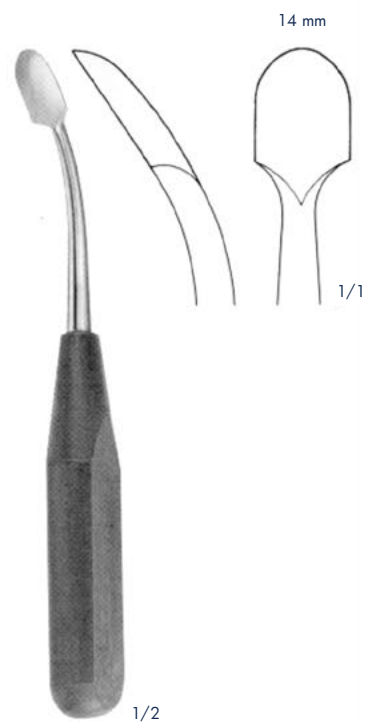

OSI190422
190 mm

Raspatories

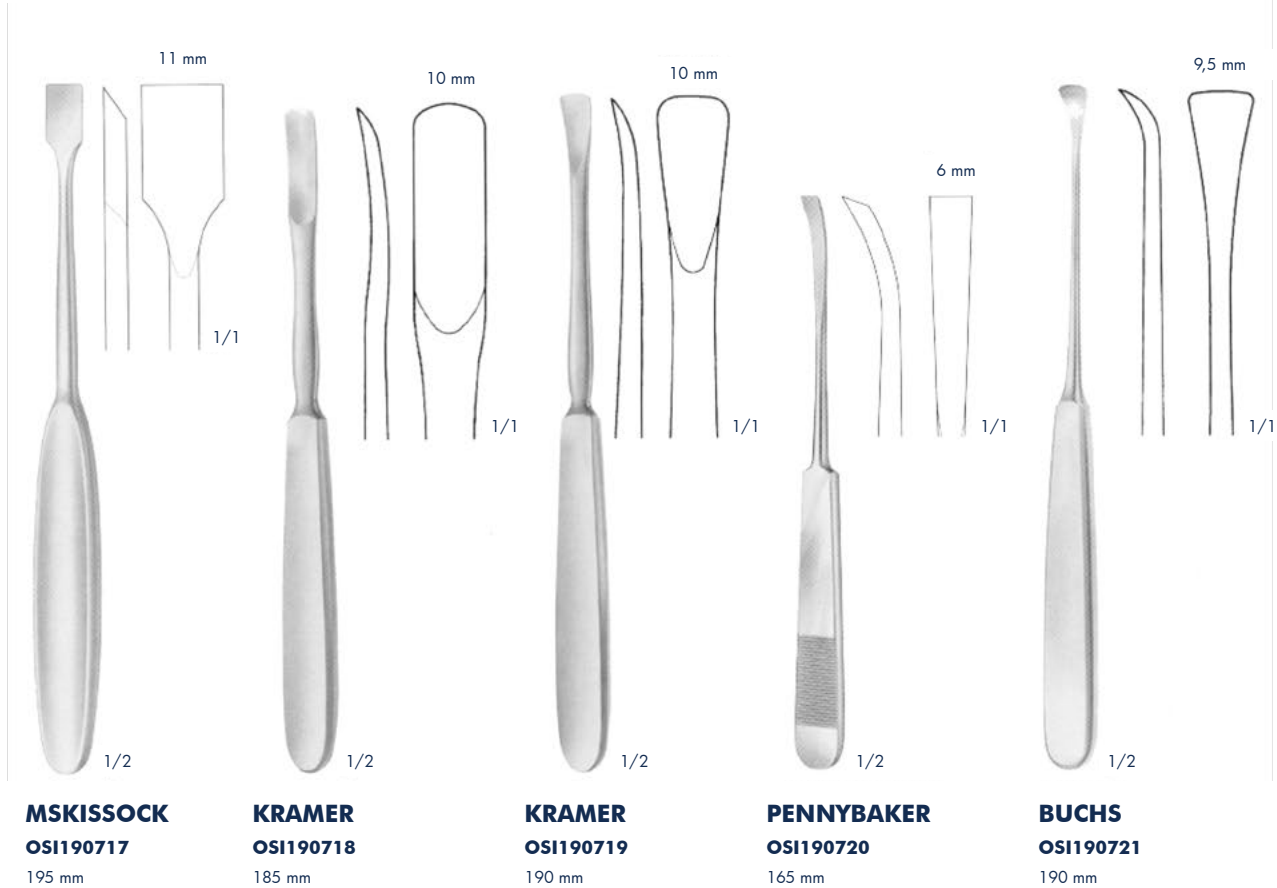
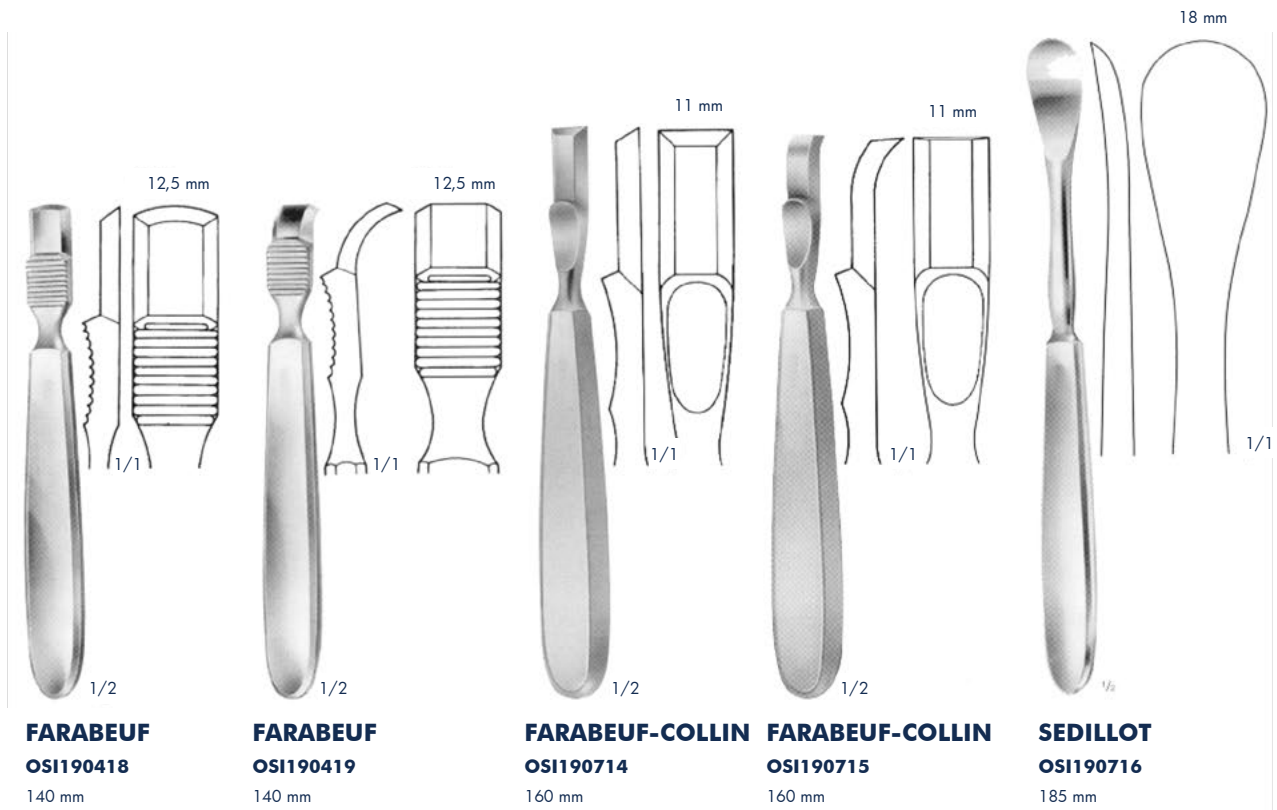

Raspatories



JANSEN
OSI190722
165 mm



LANGENBECK
OSI190414
190 mm

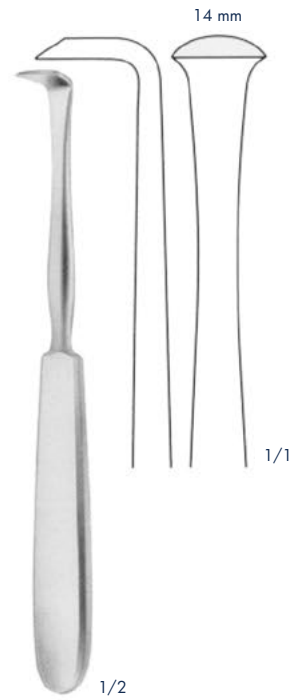

LANGENBECK
OSI190413
180 mm



KEY

	Length	Width
OSI190723	180 mm	6 mm
OSI190724	190 mm	10 mm
OSI190725	190 mm	13 mm
OSI190726	200 mm	19 mm
OSI190727	210 mm	25 mm



SCHNEIDER
OSI190728
175 mm

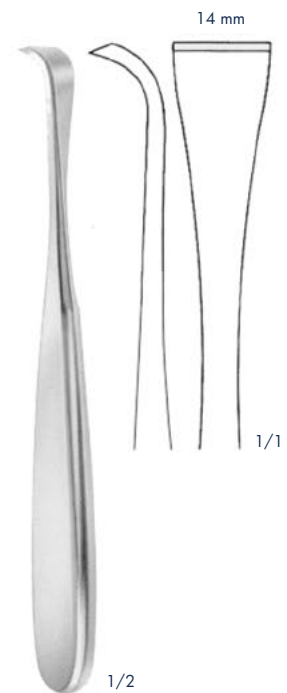

SCHNEIDER-SAUERBRUCH
OSI190729
190 mm

Raspatories

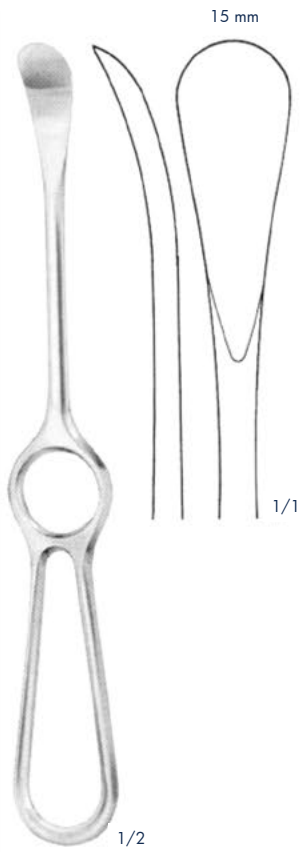

SEDILLOT
OSI190420
 215 mm

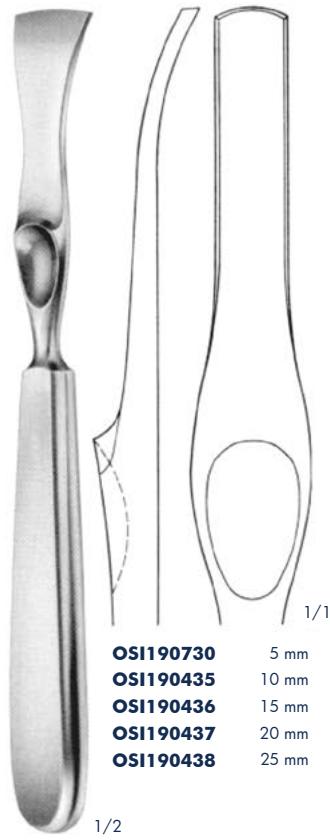

- OSI190730** 5 mm
- OSI190435** 10 mm
- OSI190436** 15 mm
- OSI190437** 20 mm
- OSI190438** 25 mm

LAMBOTTE
OSI190730 - OSI190438
 215 mm

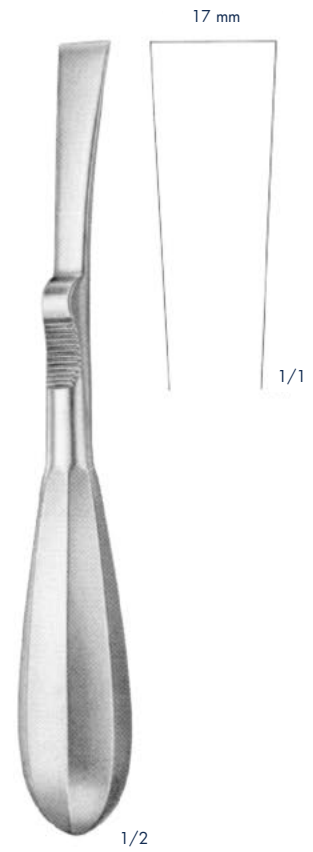

MITCHELLS
OSI190731
 210 mm

Raspatories

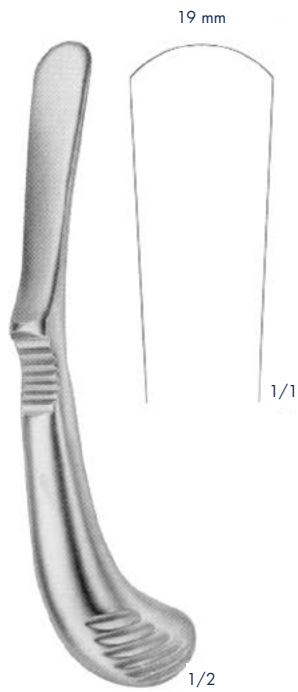

JONES
OSI190732
 170 mm



COBB
OSI190733 10 mm
OSI190734 13 mm
OSI190735 19 mm
 Spinal elevator
 290 mm

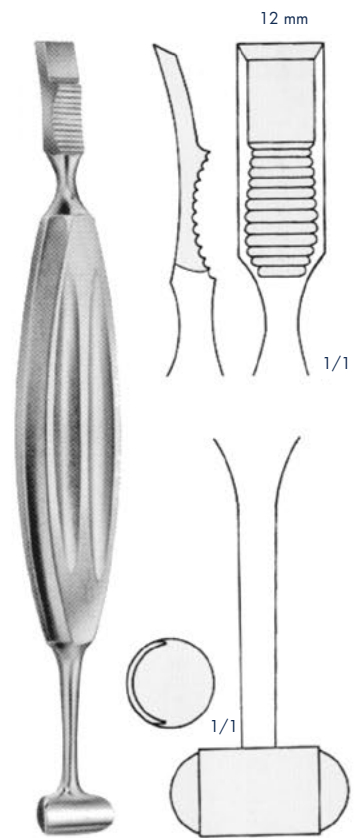

ALEXANDER
OSI190405
 210 mm

Raspatories



Raspatories with HARTPRESS - handle

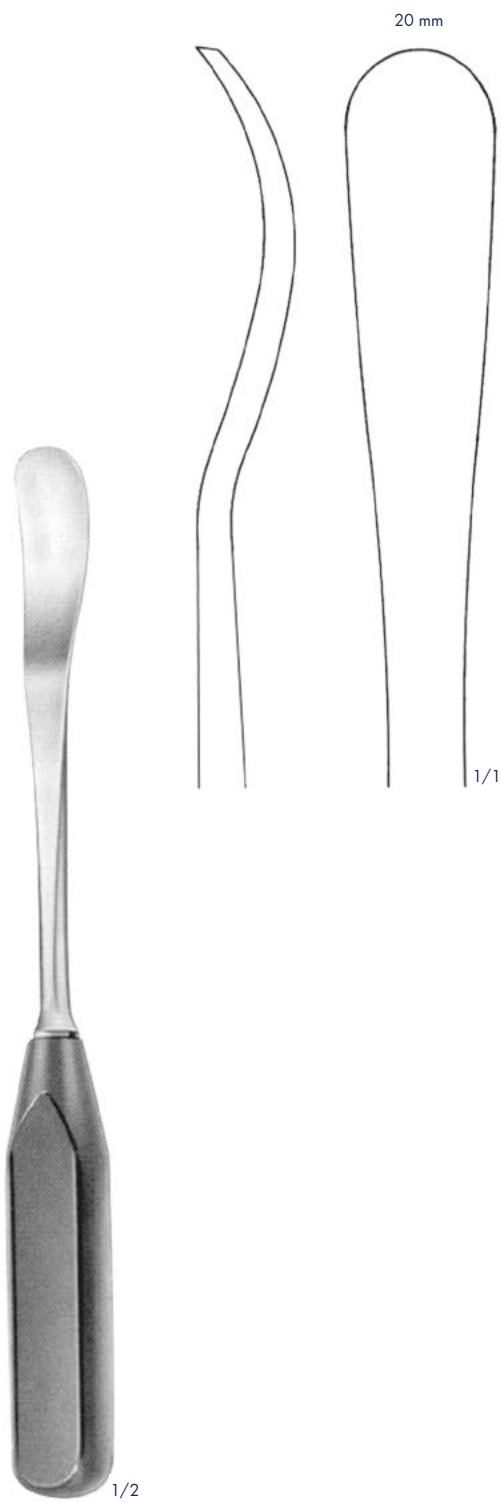

Bone Files and Rasps

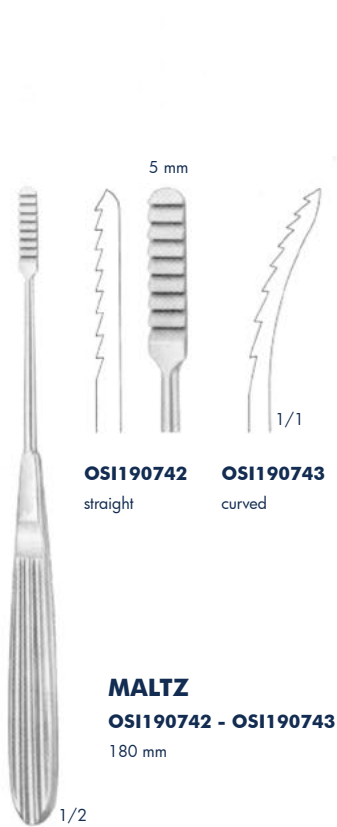

Bone Files and Rasps

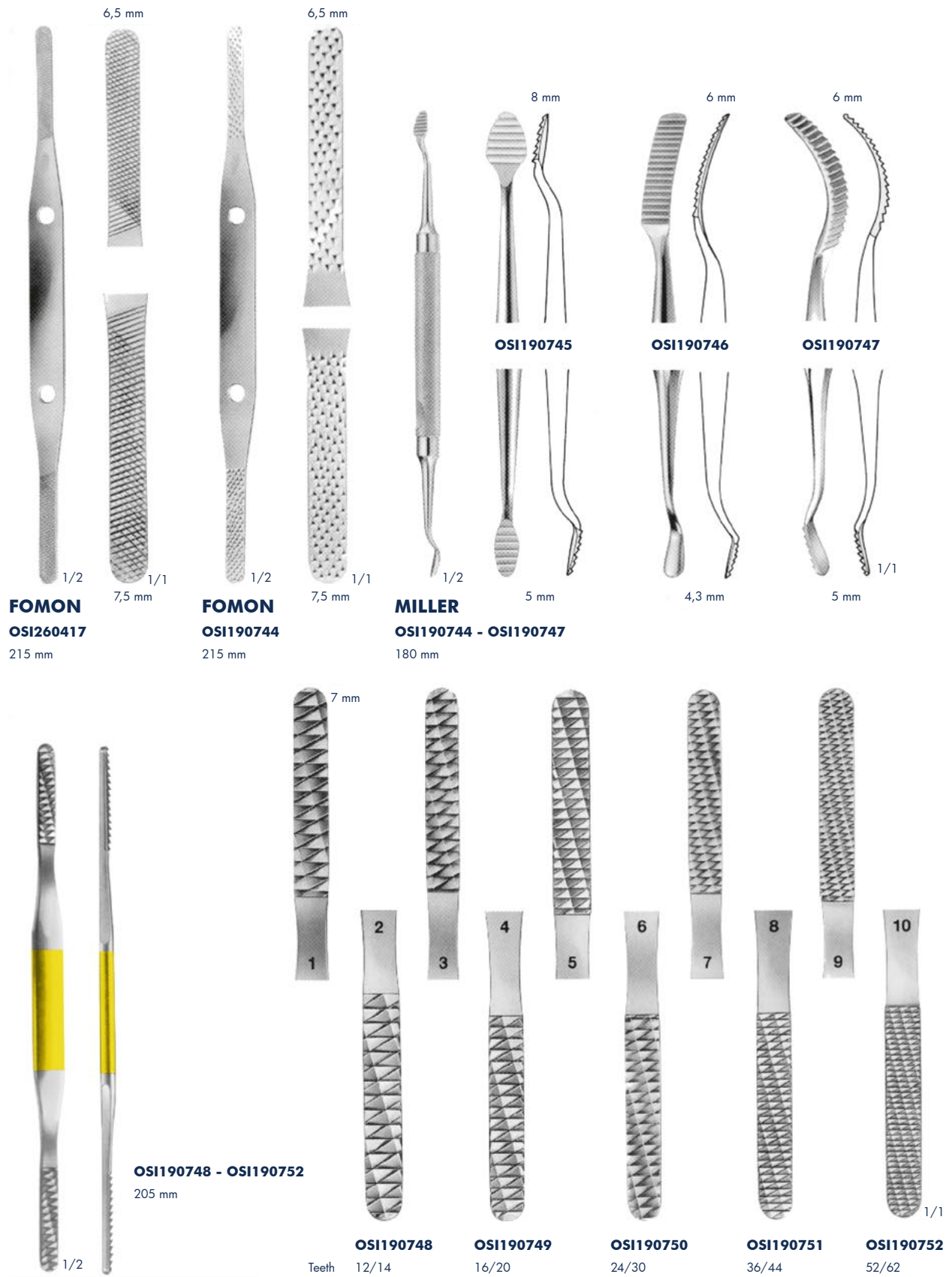

Bone Files and Rasps

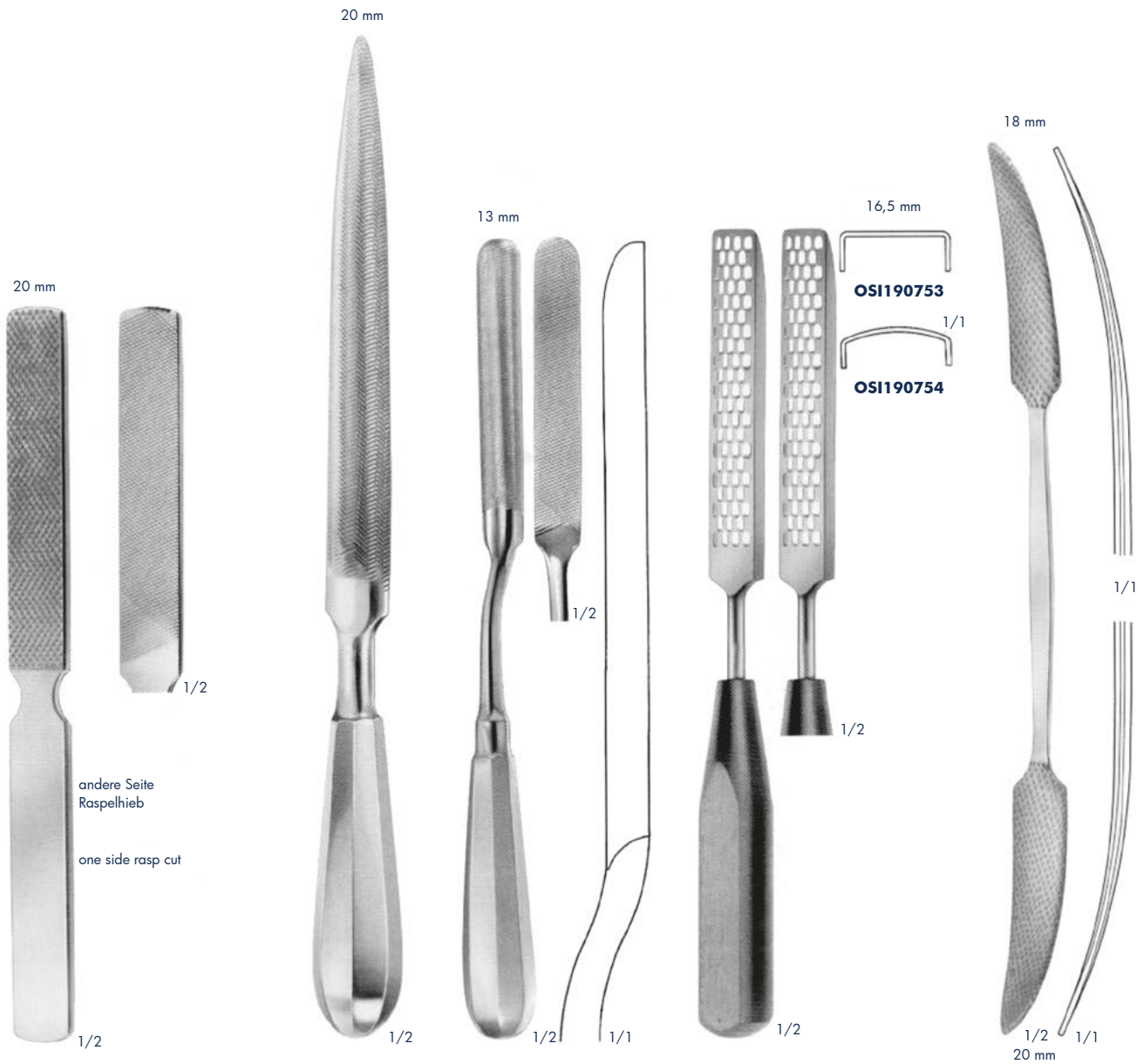

OSI190446
220 mm

OSI190444
295 mm

OSI190445
240 mm

EICHLER
OSI190753 flat
OSI190754 semi-circular
Cancellous bone rasps
243 mm

PUTTI
OSI190755
270 mm

andere Seite
Raspelhieb
one side rasp cut

Bone Curettes

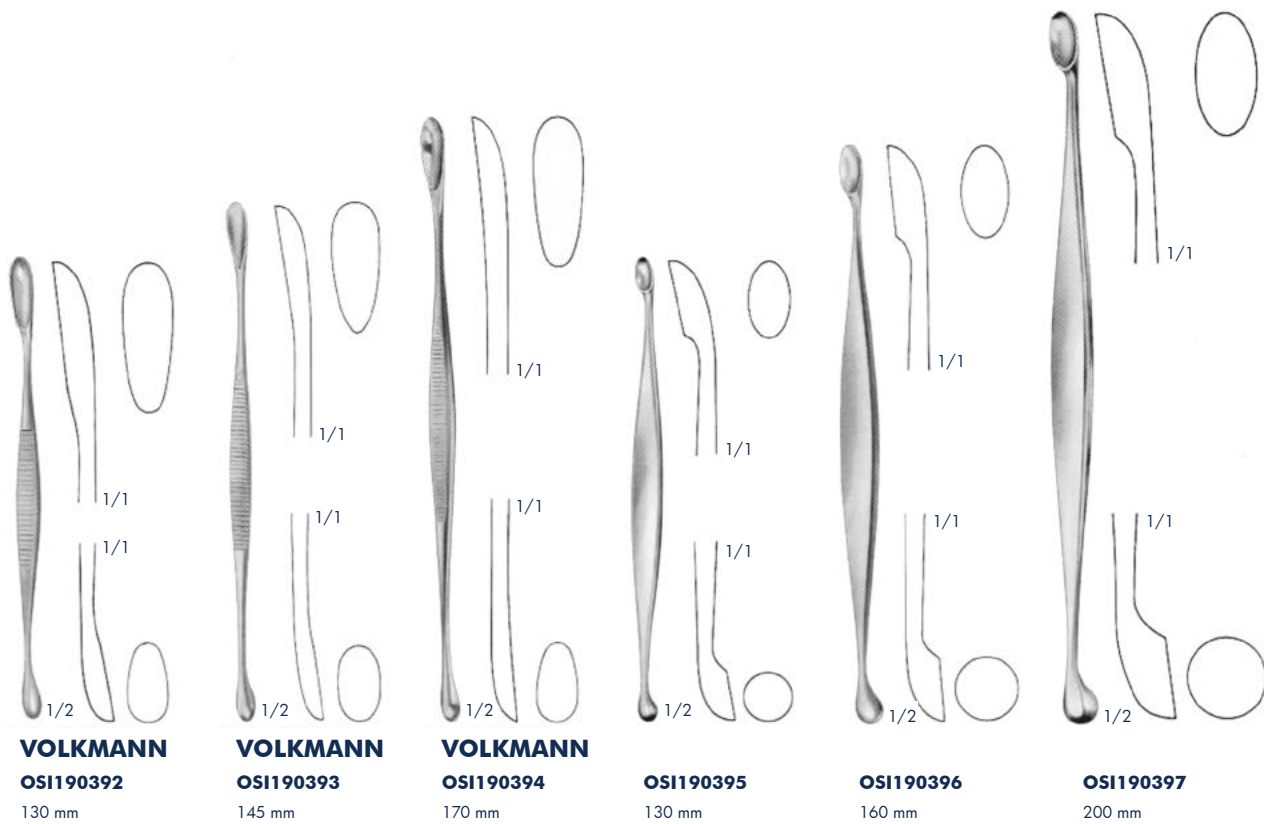
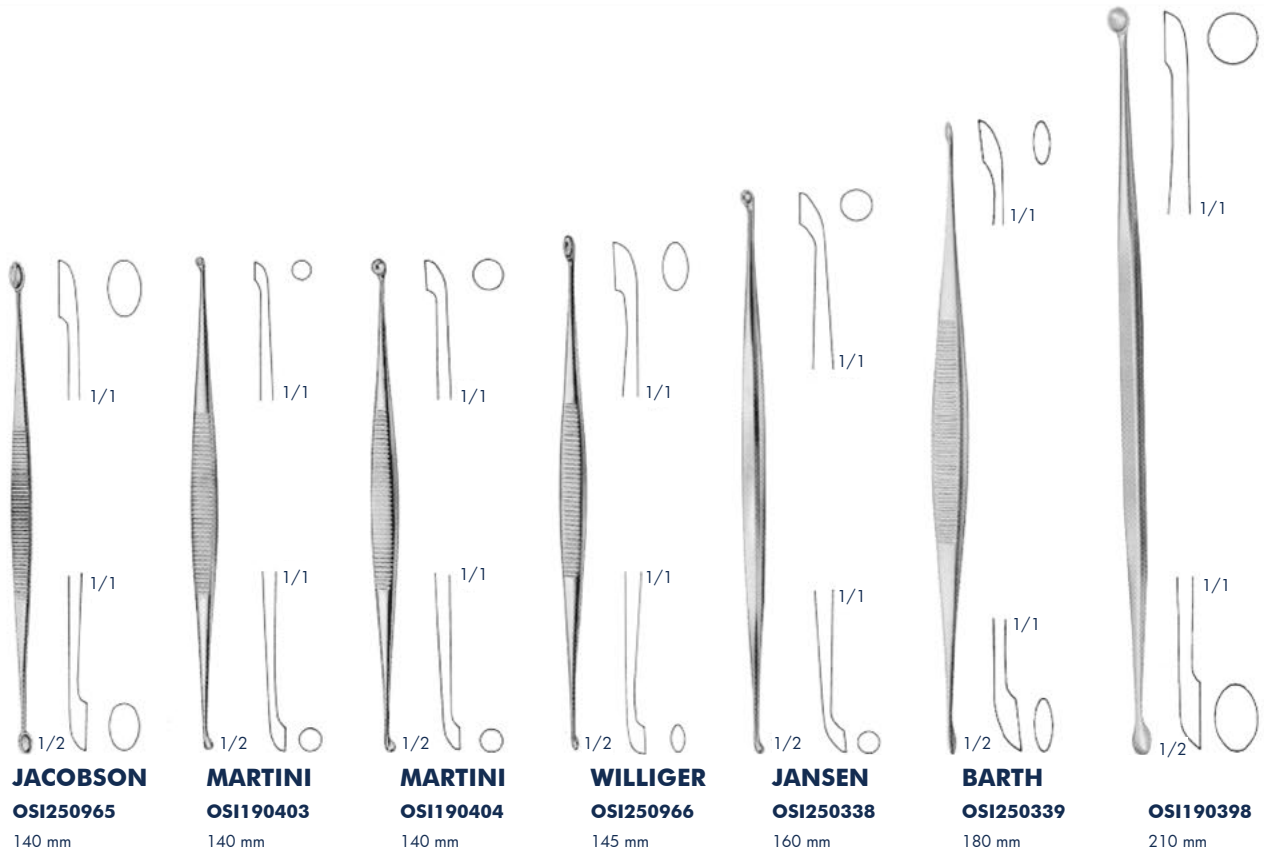

Bone Curettes

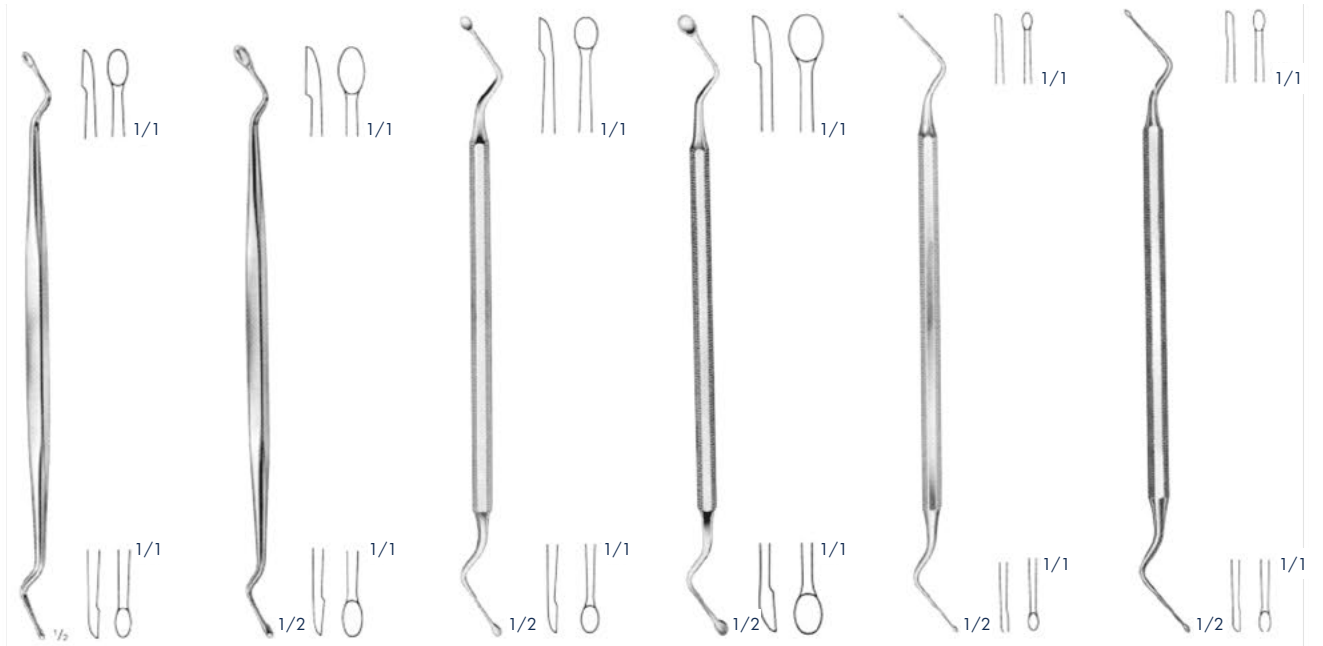

OSI190756
160 mm

JANSEN
OSI190757
160 mm

HEMINGWAY
OSI190758
170 mm

HEMINGWAY
OSI190759
170 mm

HEMINGWAY
OSI190760
170 mm
Fig. 0

HEMINGWAY
OSI190761
170 mm
Fig. 1

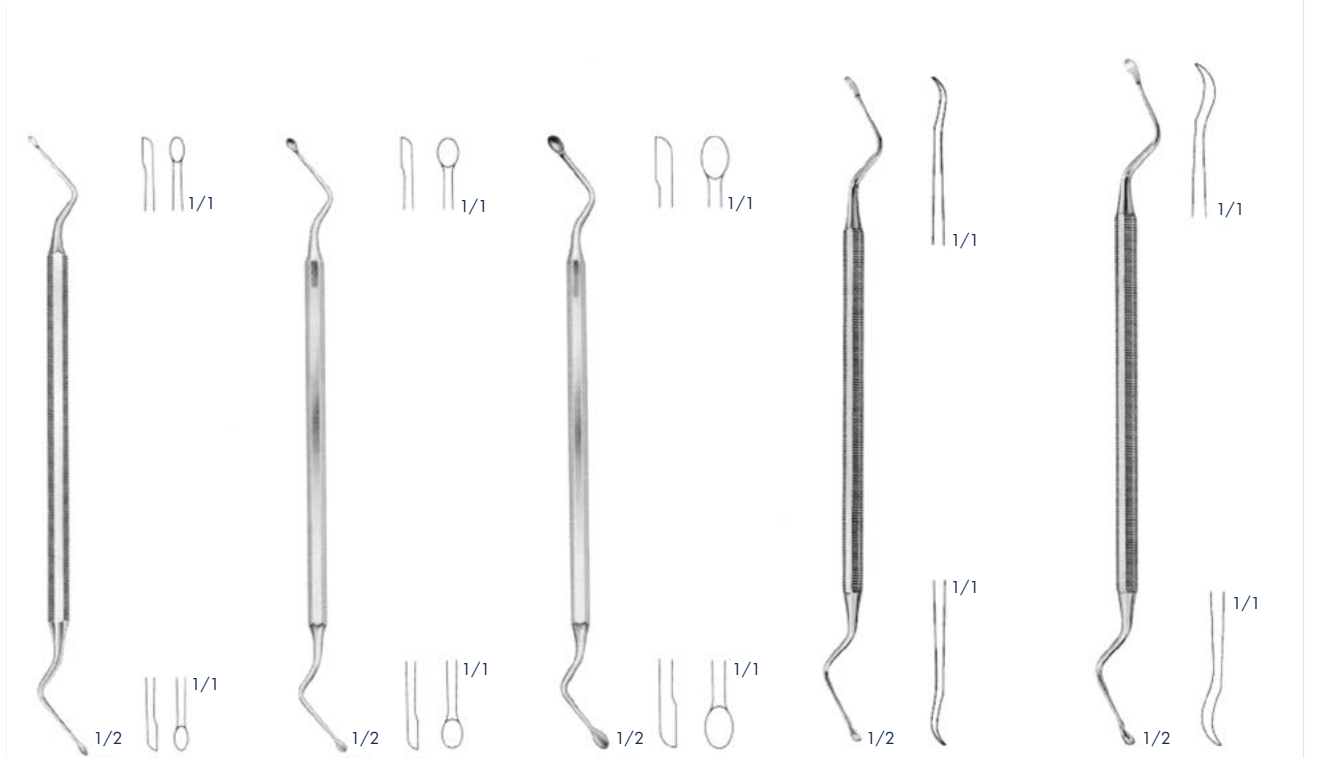

HEMINGWAY
OSI190762
170 mm
Fig. 2

HEMINGWAY
OSI190763
170 mm
Fig. 3

HEMINGWAY
OSI190764
170 mm
Fig. 4

LUCAS
OSI190765
180 mm

LUCAS
OSI190766
185 mm

Bone Curettes



1/2

KERPEL
OSI190767
OSI190768
 145 mm



1/1

OSI190767
OSI190769



1/1

OSI190768
OSI190770



1/2

KERPEL
OSI190769
OSI190770
 145 mm



1/2

UFFENORDE
OSI190771
 170 mm



1/1



1/2

UFFENORDE
OSI190772
 170 mm



1/1

Bone Curettes









3 mm	4 mm	5 mm		
				
Fig. 000	00	0		
OSI190327	OSI190328	OSI190329		

6 mm	8 mm	10 mm	12 mm	
				1/1
Fig. 1	2	3	4	
OSI190330	OSI190331	OSI190332	OSI190333	

BRUNS
OSI190327 - OSI190333
165 mm
1/2



2,5 mm	3,4 mm	4,2 mm		
				
Fig. 000	00	0		
OSI190309	OSI190310	OSI190311		

5,2 mm	6,3 mm	7,4 mm	8 mm	
				1/1
Fig. 1	2	3	4	
OSI190312	OSI190313	OSI190314	OSI190315	

SCHEDE
OSI190309 - OSI190315
170 mm
1/2



2,8 mm	3,6 mm	4,4 mm	5,2 mm	6,8 mm
				
Fig. 0000	000	00	0	1
OSI190316	OSI190317	OSI190318	OSI190319	OSI190320

8,5 mm	10 mm	11,5 mm	13 mm	14,5 mm
				
Fig. 2	3	4	5	6
OSI190321	OSI190322	OSI190323	OSI190324	OSI190325







VOLKMANN
OSI190316 - OSI190325
170 mm
1/2





3,4 mm	5,2 mm
	
Fig. 00	1
OSI190349	OSI190351

WILLIGER
OSI190349 - OSI190351
170 mm
1/2

Bone Curettes

 <p>1,8 mm OSI250383</p> <p>2,0 mm OSI250382</p> <p>2,4 mm OSI250381</p> <p>2,6 mm OSI250380</p> <p>2,8 mm OSI250379</p> <p>LEMPERT OSI250379 - OSI250383 215 mm 1/2</p>	<p>malleable</p>  <p>4,4 mm Fig. 00 OSI190389</p> <p>5,2 mm Fig. 0 OSI190390</p> <p>6,8 mm Fig. 1 OSI190391</p> <p>HALLE OSI190389 - OSI190391 215 mm 1/2</p>	 <p>2,8 mm Fig. 0000 OSI190773</p> <p>3,6 mm Fig. 000 OSI190774</p> <p>4,4 mm Fig. 00 OSI190775</p> <p>5,2 mm Fig. 0 OSI190776</p> <p>DAUBENSPECK OSI190773 - OSI190776 200 mm 1/2</p>
 <p>3,6 mm Fig. 000 OSI190777</p> <p>4,4 mm Fig. 00 OSI190778</p> <p>5,2 mm Fig. 0 OSI190779</p> <p>6,8 mm Fig. 1 OSI190780</p> <p>OSI190777 - OSI190780 250 mm 1/2</p>	 <p>3,6 mm Fig. 000 OSI190781</p> <p>4,4 mm Fig. 00 OSI190782</p> <p>5,2 mm Fig. 0 OSI190783</p> <p>6,8 mm Fig. 1 OSI190784</p> <p>OSI190781 - OSI190784 250 mm 1/2</p>	 <p>3 mm OSI190785</p> <p>4 mm OSI190786</p> <p>5 mm OSI190787</p> <p>BUSHE OSI190785 - OSI190787 250 mm 1/2</p>

Bone Curettes

 <p>6 mm 1/1</p> <p>TESSIER OSI190788 220 mm 1/2</p>	 <p>3,6 mm Fig. 000 OSI190367</p> <p>4,4 mm Fig. 00 OSI190368</p> <p>5,2 mm 1/1 Fig. 0 OSI190369</p> <p>SIMON OSI190367 - OSI190369 235 mm 1/2</p>	 <p>6,8 mm Fig. 1 OSI240295</p> <p>10 mm Fig. 3 OSI240297</p> <p>13 mm Fig. 5 OSI240299</p> <p>8,5 mm Fig. 2 OSI240296</p> <p>11,5 mm Fig. 4 OSI240298</p> <p>14,5 mm 1/1 Fig. 6 OSI240300</p> <p>SIMON OSI240295 - OSI240300 max. 240 mm</p>
--	---	--

 <p>3,6 mm Fig. 000 OSI190789</p> <p>4,4 mm Fig. 00 OSI190790</p> <p>5,2 mm 1/1 Fig. 0 OSI190791</p> <p>CASPAR OSI190789 - OSI190791 220 mm 1/2</p>	 <p>3,6 mm Fig. 000 OSI190792</p> <p>4,4 mm Fig. 00 OSI190793</p> <p>5,2 mm 1/1 Fig. 0 OSI190794</p> <p>CASPAR OSI190792 - OSI190794 220 mm 1/2</p>	 <p>4 mm OSI190795</p> <p>5 mm OSI190796</p> <p>6 mm 1/1 OSI190797</p> <p>CASPAR OSI190795 - OSI190797 toothed 220 mm 1/2</p>
---	---	---

Curettes



CASPAR
OSI190798 - OSI190799
toothed
250 mm



CASPAR
OSI190800 - OSI190801
toothed
270 mm

Bone Curettes HARTPRESS - handle



1/2

OSI190304 - OSI190307

270 mm

4,4 mm



Fig. 00

OSI190304

6,8 mm



Fig. 1

OSI190305

8,5 mm



Fig. 2

OSI190306

10 mm

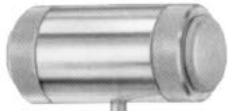

Fig. 3

OSI190307

1/1

Mallets



Ø 20 mm



1/2

MEAD

OSI180189 180 g

with interchangeable
plastic disks

190 mm

OSI180188

Pair of spare disks



Ø 25 mm



1/2

OSI180190 135 g

with interchangeable
plastic disks

185 mm

OSI180191

Pair of spare disks



Ø 30 mm



1/2

COTTLE

OSI180192 235 g

1 side convex

185 mm



Ø 25 mm



1/2

OSI180193 240 g

With one smooth and one
rough surface

185 mm

Mallets



Ø 22 mm

OS1180194 80 g
lead filled head
165 mm

1/2



Ø 23 mm

FICKLING
OS1180195 190 g
190 mm

1/2



Ø 22 mm

OS1180196 155 g
lead filled head
190 mm

1/2



Ø 27 mm

HAJEK
OS1180197 130 g
220 mm

1/2

Mallets



Ø 30 mm

OSI180198 200 g
with interchangeable plastic disks
245 mm

OSI180199
Pair of spare disks

1/2



HARTPRESS
can be sterilized in a steam sterilizer up to 143 °C (^3 bar)

OSI180200 Ø 35 mm
OSI180201 Ø 42 mm
OSI180202 Ø 50 mm
250 mm

1/2



Ø 35 mm

WAGNER
OSI180203

complete with:
1 pair of metal disks OSI180204 and
1 pair of plastic disks OSI180205 and
1 wrench
235 mm

1/2



OSI180204 215 g
1 metal disk, flat
1 metal disk, convex



OSI180205 30 g
1 metal disk, flat
1 metal disk, convex

Mallets



Ø 27 mm

Ø 13,5 mm

1/2

OS1180206 425 g
Head made of material used
for implants
235 mm



Ø 45 mm

1/2

BERGMANN
OS1180207 300 g
245 mm



Ø 30 mm

1/2

BERGMANN
OS1180208 245 g
235 mm

Mallets



OS1180209 285 g
240 mm



OMBREDANNE
OS1180210 520 g
240 mm



HEATH
OS1180211 600 g, Ø40 mm
185 mm
OS1180212 1000 g, Ø45 mm
200 mm

cooper filled head

Tampers

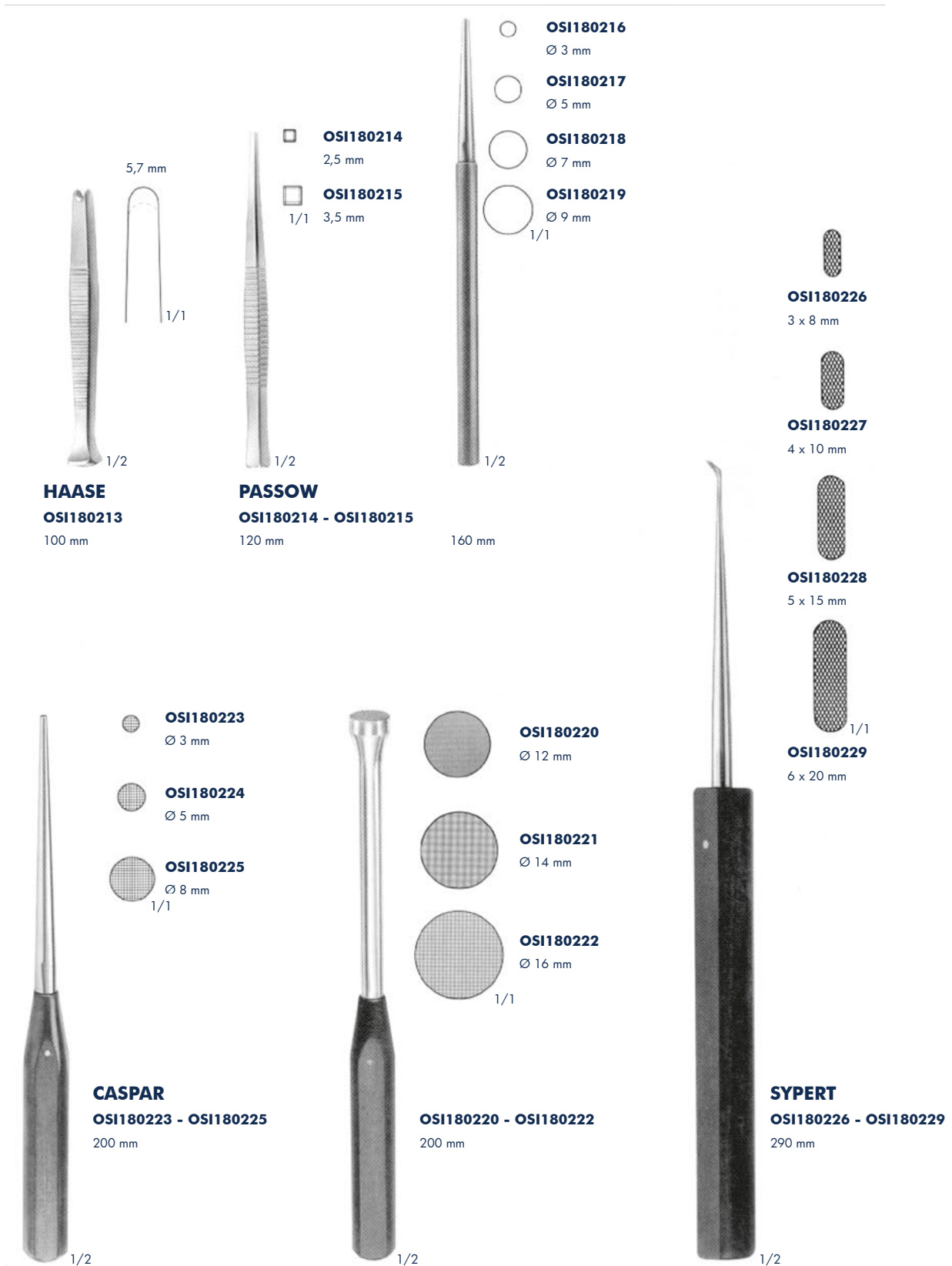

Osteotomes, Chisels and Gouges

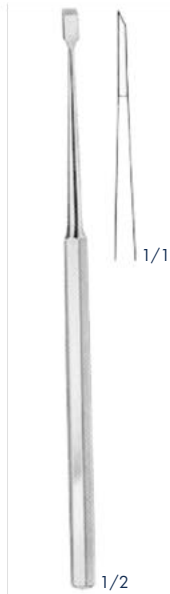

FREER
OSI250547 4 mm
 Chisel
 160 mm

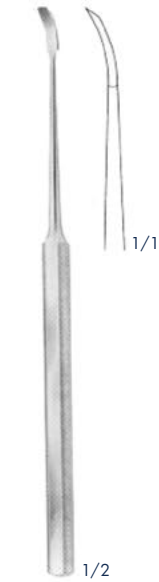

FREER
OSI250546 4 mm
 gebogen
 Chisel, curved
 160 mm

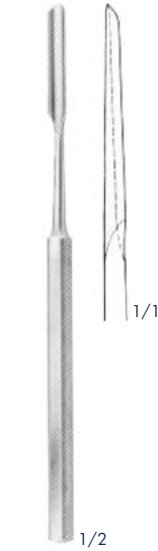

FREER
OSI250548 6 mm
 Gouge
 150 mm



OSI190124 3,4 mm
 Scaphoid gouge,
 downwards curved
 135 mm

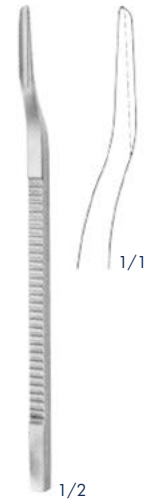

OSI190125 3,4 mm
 Scaphoid gouge,
 upwards curved
 135 mm

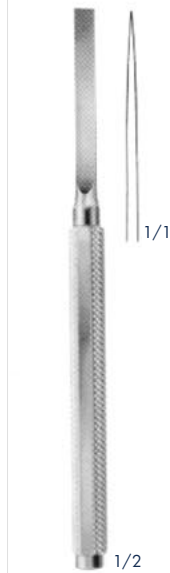

MANNERFELT modif.
OSI180230 4 mm
OSI180231 6 mm
OSI180232 8 mm
 Osteotomes
 155 mm



MANNERFELT modif.
OSI180233 3 mm
 Gouge
 155 mm



KRAMER
OSI180234 2,6 mm
 Chisel for osteophytes
 with handle
 170 mm

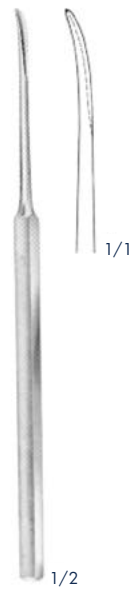

THIES
OSI250969 2 mm
OSI250970 3 mm
OSI250971 4 mm
 Gouges
 160 mm

Osteotomes, Chisels and Gouges

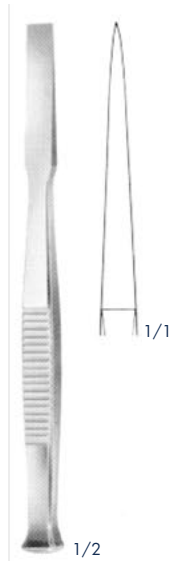

- OSI250972** 4 mm
- OSI250973** 6 mm
- OSI190107** 8 mm
- OSI190108** 10 mm
- OSI190109** 12 mm

Osteotomes
140 mm

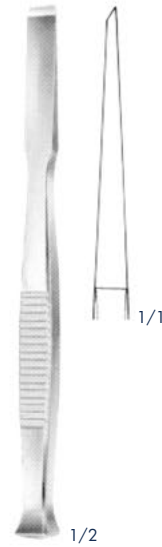

- OSI250974** 4 mm
- OSI250975** 6 mm
- OSI190112** 8 mm
- OSI190113** 10 mm
- OSI190114** 12 mm

Chisels
140 mm



GILLIES

- OSI180235** 5 mm
- OSI180236** 7 mm
- OSI180237** 9 mm

Osteotome
140 mm

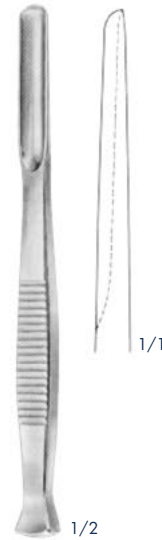

- OSI250976** 4 mm
- OSI250977** 6 mm
- OSI190117** 8 mm
- OSI190118** 10 mm
- OSI190119** 12 mm

Gouges
140 mm

Chisels and Gouges



PARTSCH

- OSI190127** 3 mm
 - OSI190128** 4 mm
 - OSI190129** 5 mm
 - OSI190130** 6 mm
- Chisels
140 mm

1/2



PARTSCH

- OSI190131** 3 mm
 - OSI190132** 4 mm
 - OSI190133** 5 mm
 - OSI190134** 6 mm
 - OSI190135** 7 mm
- Chisels
170 mm

1/2



PARTSCH

- OSI190137** 3 mm
 - OSI190138** 4 mm
 - OSI190139** 5 mm
 - OSI190140** 6 mm
- Gouges
140 mm

1/2

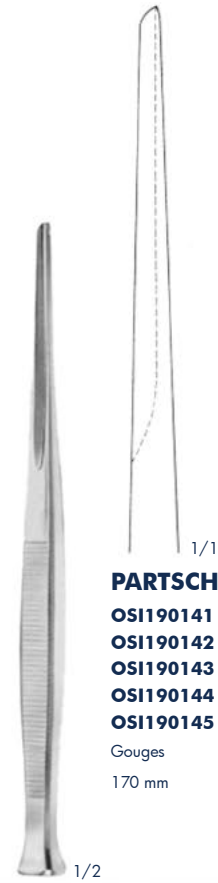

PARTSCH

- OSI190141** 3 mm
 - OSI190142** 4 mm
 - OSI190143** 5 mm
 - OSI190144** 6 mm
 - OSI190145** 7 mm
- Gouges
170 mm

1/2

Osteotomes, Chisels and Gouges



LUCAS

OS1180238 4 mm
OS1180239 6 mm

Chisels
 160 mm



LUCAS

OS1180240 3 mm
OS1180241 5 mm

Gouges
 160 mm



ALEXANDER

OS1190153 5 mm
OS1190154 7 mm
OS1190155 9 mm
OS1190156 11 mm

Gouges
 170 mm



LAMBOTTE

OS1190199 4 mm
OS1190200 6 mm
OS1190201 8 mm
OS1190202 10 mm
OS1190203 12 mm
OS1190204 15 mm

Osteotomes
 125 mm



COTTLE

OS1180242 4 mm
OS1180243 6 mm
OS1180244 8 mm
OS1180245 10 mm
OS1180246 12 mm

Osteotomes with
 depth markings
 180 mm



COTTLE

OS1250551 4 mm
OS1250552 7 mm
OS1250553 9 mm
OS1250554 12 mm

Chisel-Osteotomes
 with depth markings
 180 mm



COTTLE

OS1260410 8 mm

Fishtail chisel,
 with protected ends
 180 mm

Chisels, Osteotomes



Chisels and Gouges, Osteotomes



STILLÉ

- OSI190158** 10 mm
- OSI180253** 12 mm
- OSI190159** 15 mm
- OSI190160** 20 mm
- OSI190161** 25 mm

Chisels
205 mm

1/2

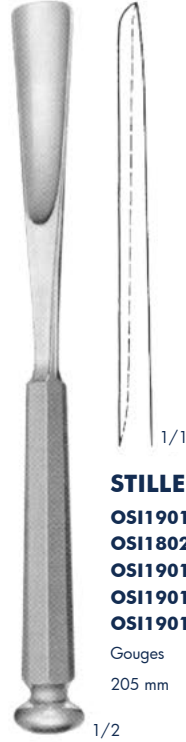

STILLÉ

- OSI190166** 10 mm
- OSI180254** 12 mm
- OSI190167** 15 mm
- OSI190168** 20 mm
- OSI190169** 25 mm

Gouges
205 mm

1/2



WALTER

- OSI180255** 10 mm
- OSI180256** 15 mm

Gouges for taking
grafts from the ribs
205 mm

1/2



STILLÉ

- OSI180257** 8 mm
- OSI190162** 10 mm
- OSI180258** 12 mm
- OSI190163** 15 mm
- OSI190164** 20 mm
- OSI190165** 25 mm

Osteotomes
205 mm

1/2



STILLÉ

- OSI180259** 10 mm
- OSI180260** 12 mm
- OSI180261** 15 mm
- OSI180262** 20 mm
- OSI180263** 25 mm

Osteotomes
205 mm

1/2



STILLÉ

- OSI180264** 10 mm
- OSI180265** 12 mm
- OSI180266** 15 mm
- OSI180267** 20 mm
- OSI180268** 25 mm

Osteotomes, curved
205 mm

1/2

Osteotomes

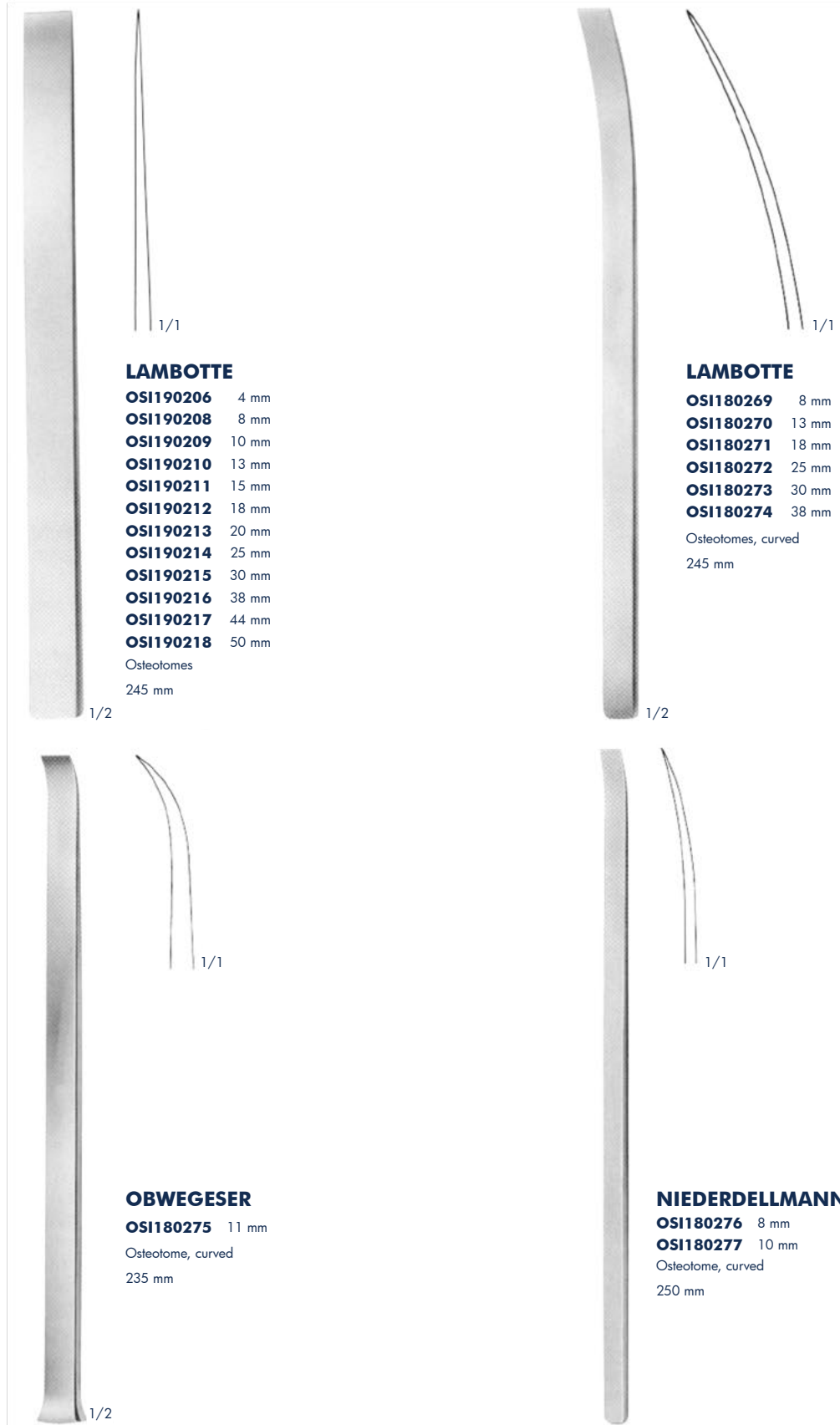

LAMBOTTE

- OSI190206** 4 mm
- OSI190208** 8 mm
- OSI190209** 10 mm
- OSI190210** 13 mm
- OSI190211** 15 mm
- OSI190212** 18 mm
- OSI190213** 20 mm
- OSI190214** 25 mm
- OSI190215** 30 mm
- OSI190216** 38 mm
- OSI190217** 44 mm
- OSI190218** 50 mm

Osteotomes
245 mm

LAMBOTTE

- OSI180269** 8 mm
- OSI180270** 13 mm
- OSI180271** 18 mm
- OSI180272** 25 mm
- OSI180273** 30 mm
- OSI180274** 38 mm

Osteotomes, curved
245 mm

OBWEGESER

- OSI180275** 11 mm
- Osteotome, curved
235 mm

NIEDERDELLMANN

- OSI180276** 8 mm
 - OSI180277** 10 mm
- Osteotome, curved
250 mm

Osteotomes Chisels and Gouges with HARTPRESS - handle



1/2

OSI180278
Handle for interchangeable blades, with key



1/2 breit/wide

OSI180279 5 mm
OSI180280 10 mm
OSI180281 16 mm
OSI180282 25 mm
Interchangeable blades,
usable length: 45 mm



1/2 breit/wide

OSI180283 25 mm
Interchangeable
osteotome blade,
usable length: 78 mm



1/2

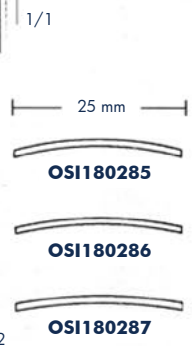

25 mm

OSI180285

OSI180286

OSI180287

1/1

r = 50 mm
r = 60 mm
r = 70 mm

25 mm wide
Interchangeable chisel
blades, hollow



1/2



1/1

OSI180288 10 mm
OSI180289 15 mm
OSI180290 20 mm
Osteotomes
200 mm



1/2



1/1

OSI180291 10 mm
OSI180292 15 mm
OSI180293 20 mm
Osteotomes, curved
200 mm

Osteotomes Chisels and Gouges with HARTPRESS - handle



1/2



1/1

LEXER-MINI

- OSI190176** 4 mm
- OSI190177** 6 mm
- OSI190178** 8 mm
- OSI190179** 10 mm
- OSI190180** 12 mm

Osteotomes
180 mm



1/2



1/1

LEXER-MINI

- OSI190181** 4 mm
- OSI190182** 6 mm
- OSI190183** 8 mm
- OSI190184** 10 mm
- OSI190185** 12 mm

Gouges
180 mm



1/2



1/1

LEXER

- OSI180284** 5 mm
- OSI190186** 7 mm
- OSI190187** 10 mm
- OSI190188** 15 mm
- OSI190189** 20 mm
- OSI190190** 25 mm
- OSI190191** 30 mm

Osteotomes
220 mm



1/2



1/1

LEXER

- OSI180294** 5 mm
- OSI190192** 7 mm
- OSI190932** 10 mm
- OSI190194** 15 mm
- OSI190195** 20 mm
- OSI190196** 25 mm
- OSI190197** 30 mm

Gouges
220 mm



1/2



1/1

OSI180295 9 mm

Gouges for removing
broken screws
220 mm



1/2



1/1

ZIELKE

- OSI180296** 5,5 mm
- OSI180297** 9,0 mm

Gouges for
scoliosis operations
230 mm

Osteotomes Chisels and Gouges with HARTPRESS - handle

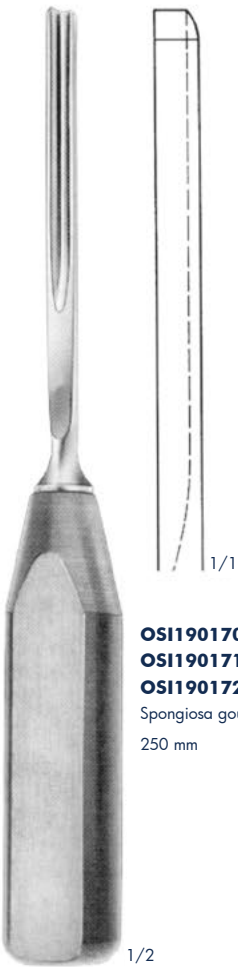

OSI190170 5 mm
OSI190171 10 mm
OSI190172 15 mm
 Spongiosa gouges
 250 mm



OSI180298 6 mm
OSI180299 8 mm
OSI180300 11 mm
OSI180301 16 mm
 Lamina gouge cranked
 235 mm

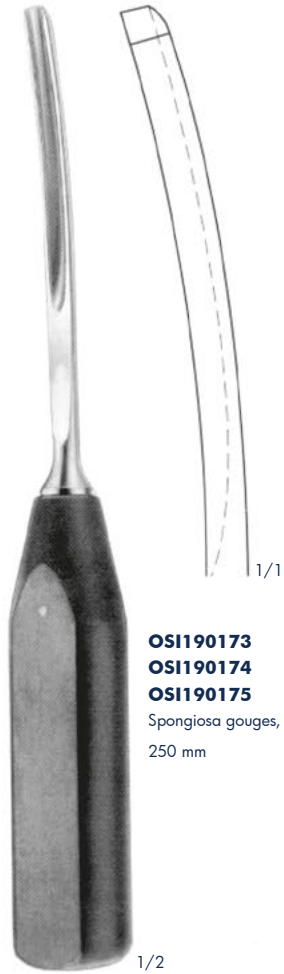

OSI190173 5 mm
OSI190174 10 mm
OSI190175 15 mm
 Spongiosa gouges, curved
 250 mm

Osteotomes Chisels and Gouges with HARTPRESS - handle



OSI180302 20 mm
Chisel
245 mm

OSI180303 16 mm
Chisel, curved
265 mm

LEXER
OSI180304 10 mm
OSI180305 15 mm
Osteotomes angled
275 mm

LEXER
OSI180306 10 mm
OSI180307 15 mm
Gouges, angled
275 mm

Gouges with HARTPRESS - handle

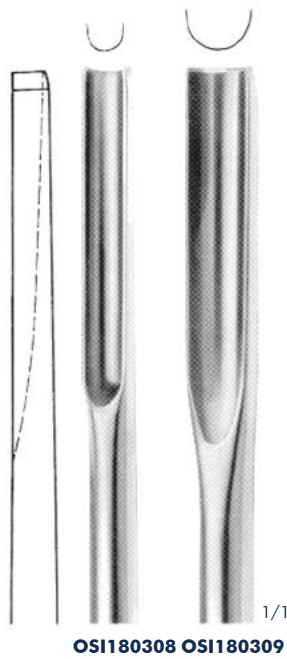
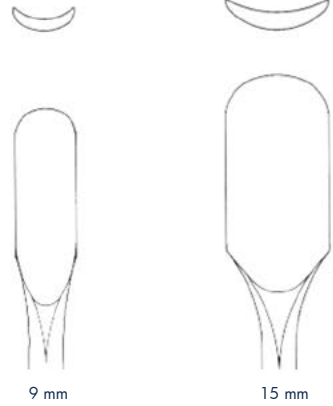

LEXER
OSI180308 - OSI180309
 Spongiosa gouges
 280 mm



1/2

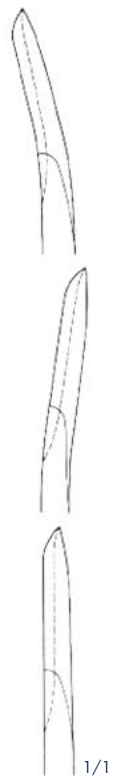

WAGNER
OSI180310 - OSI180315

Long handled thin concave osteotomes for removal of osteophytes as well as for creating small notches throughout the Acetabular surface. The instruments can also be used for removing bone cement from the marrow-cavity when removing a total hip prosthesis.
 340 mm



1/2

OSI180310
 inclined forward

OSI180312
 inclined forward

OSI180311
 inclined backward

OSI180313
 inclined backward

OSI180314
 straight

OSI180315
 straight

Distractor, Reposition Forceps

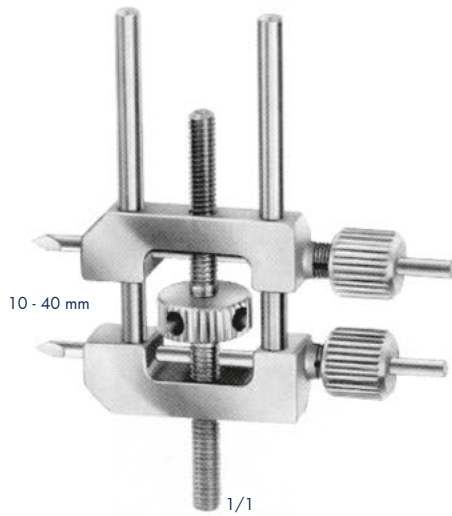

OSI190802

Small distractor, a repositioning device for distraction and compression of small bones, for wires with 3.0 mm diam.

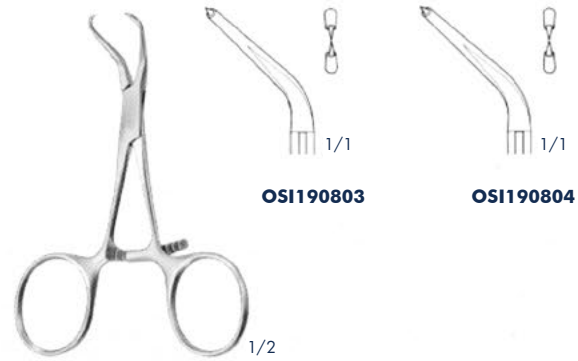

OSI190803

OSI190804

Reposition forceps with stepped tips
95 mm



OSI190805

Reposition forceps, for small fragments
135 mm



OSI190498

Reposition forceps, especially for maxillary reposition
135 mm



HAASE

OSI190806

Reposition forceps, for mandibular fractures
165 mm

Reposition Forceps, Reposition tamper

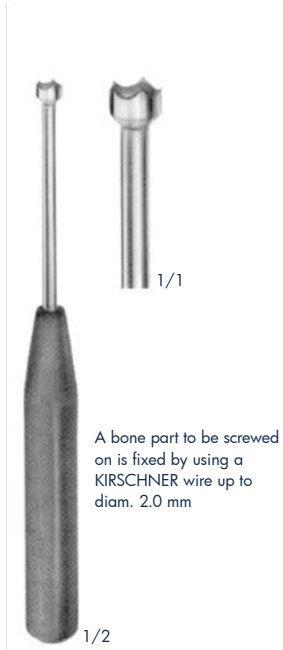

WÖRRLEIN
OSI190807
 Reposition tamper, cannulated
 165 mm

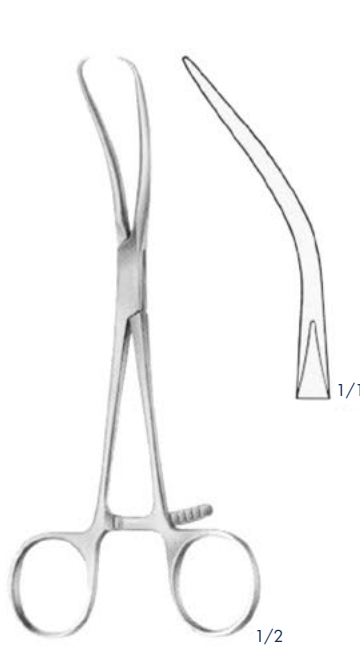

REILL
OSI190808
 Reposition forceps
 170 mm



OSI190809
 Reposition forceps
 205 mm



MEYER
OSI190810

Reposition forceps for fingers,
 with drill guide for
 KIRSCHNER wires up to
 diam. 1.0 mm
 170 mm

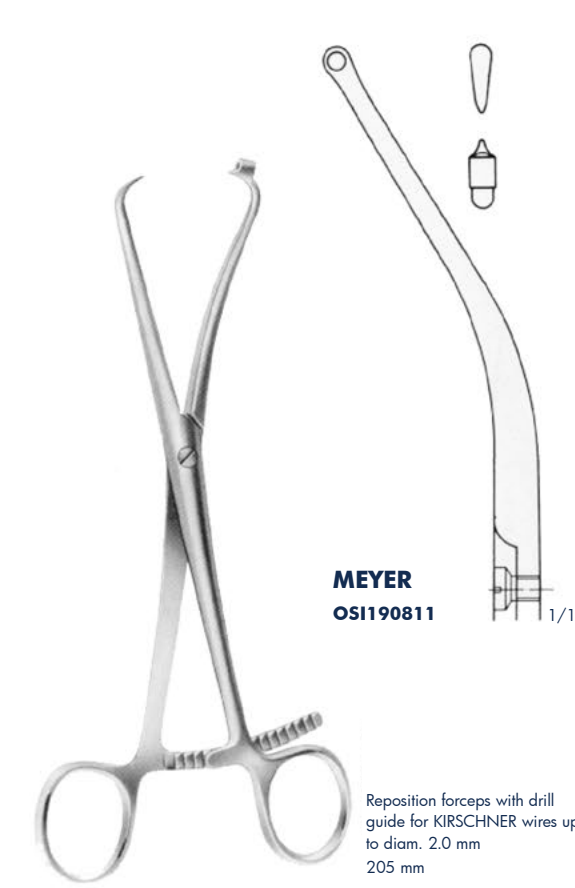

MEYER
OSI190811

Reposition forceps with drill
 guide for KIRSCHNER wires up
 to diam. 2.0 mm
 205 mm

Reposition Forceps, Bone Holding Forceps

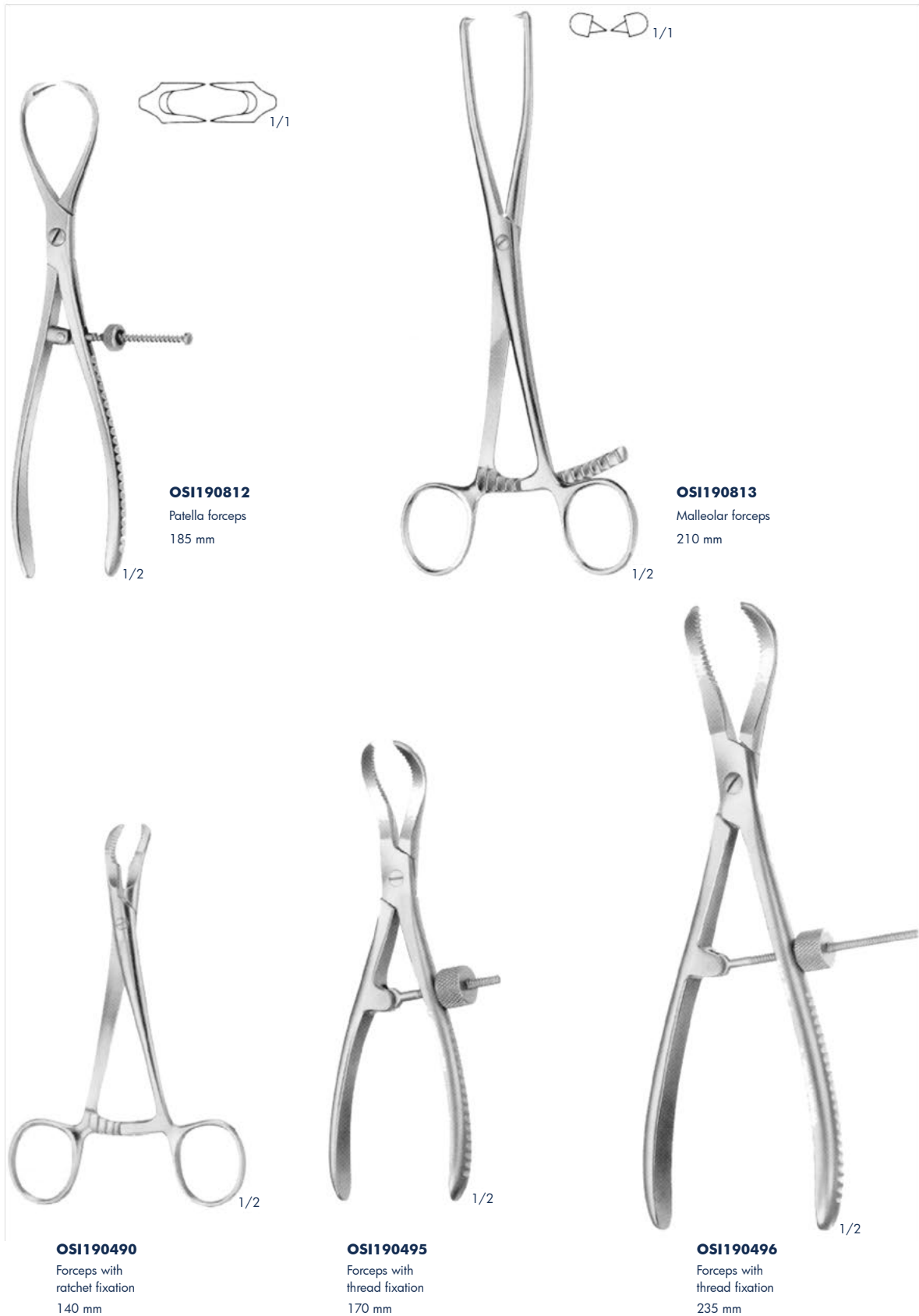

Bone Holding Forceps

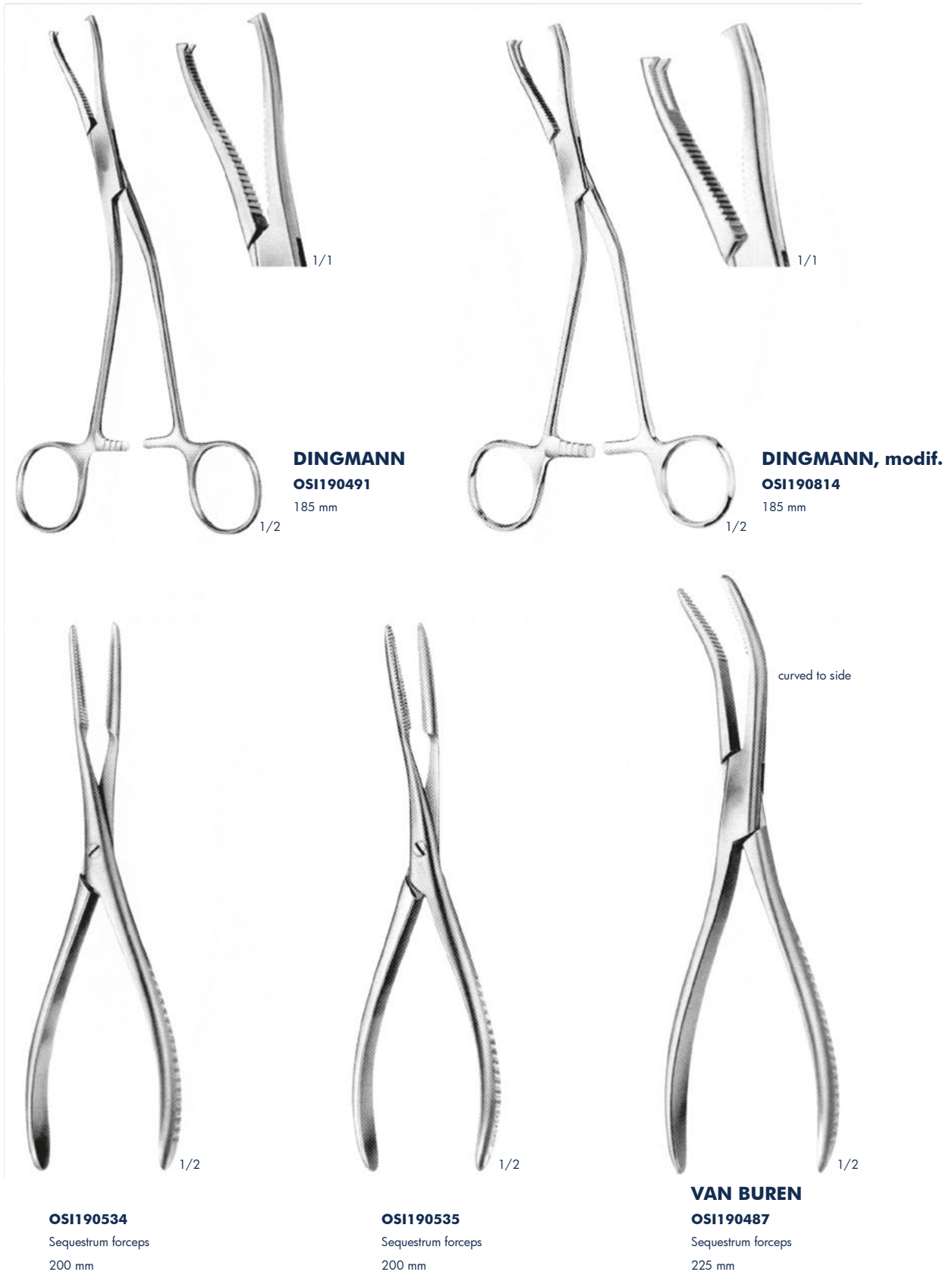

Bone Holding Forceps



OSI190502
200 mm



LANGENBECK
OSI190499
205 mm



FERGUSSON
OSI190500
205 mm



SEMB
OSI190507
190 mm



SEMB
OSI190815
190 mm

Bone Holding Forceps

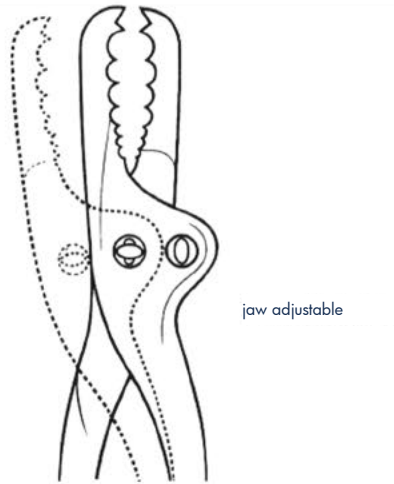

FARABEUF
OSI190508
230 mm



FARABEUF
OSI190509
255 mm



FARABEUF-LAMBOTTE
OSI190510
255 mm

Bone Holding Forceps



Bone Holding Forceps



KERN-MINI
OSI190505
155 mm



KERN-LANE
OSI190817
240 mm



LANE
OSI190818
320 mm

Bone Holding Forceps

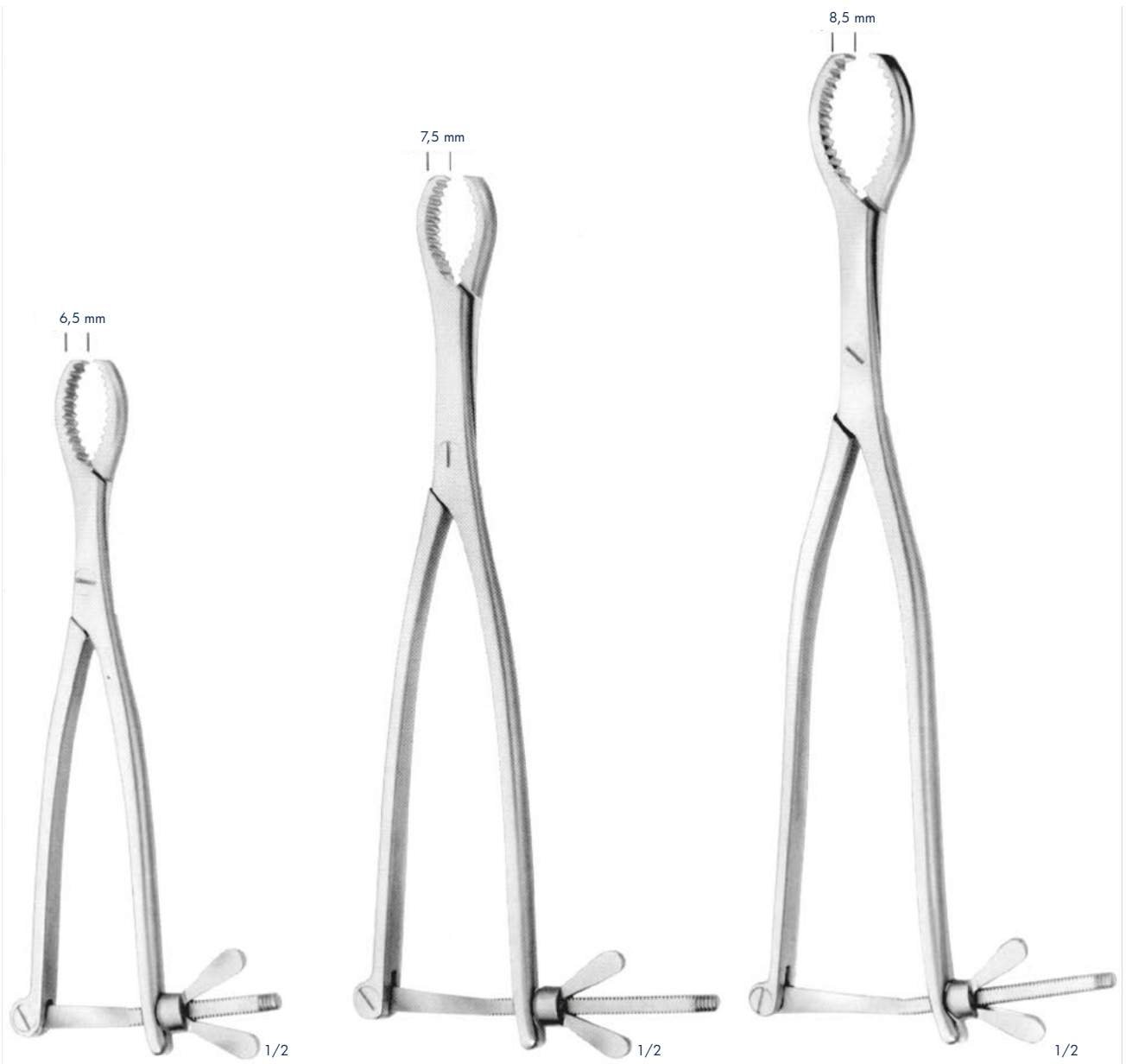

HEY GROVES
OSI190819
210 mm

HEY GROVES
OSI190820
270 mm

HEY GROVES
OSI190821
305 mm

Bone Holding Forceps

3 mm 2,5 mm 7 mm 10,5 mm 3,5 mm

OSI190525 OSI190526 OSI190527

Fig. 0 Fig. 1

for small fragments

11 mm 11,5 mm 3,5 mm 4,5 mm

OSI190528 OSI190529

Fig. 2 Fig. 3

Self-centering forceps with thread fixation

- OSI190525 145 mm
- OSI190526 190 mm
- OSI190527 240 mm
- OSI190528 260 mm
- OSI190529 280 mm

5 mm 10 mm 4 mm 11 mm 4,5 mm

OSI190536 OSI190537

Fig. 1 Fig. 2

small

with lip joint

12 mm 4,5 mm

VERBRUGGE OSI190539 175 mm

VERBRUGGE OSI190536 255 mm
OSI190537 265 mm
OSI190538 270 mm

Fig. 3

Bone Holding Forceps

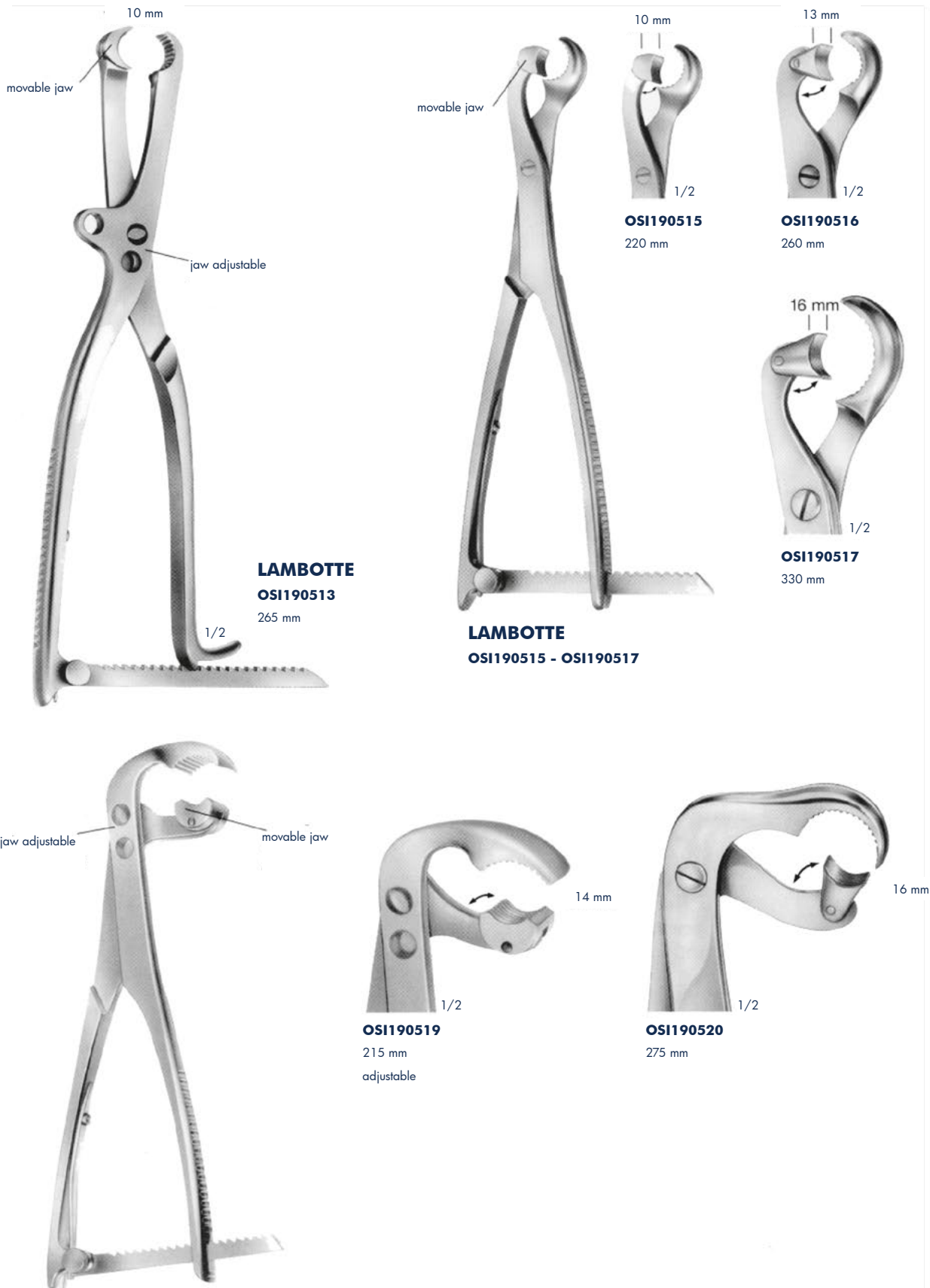

Bone Clamps



LOWMAN
OSI180152 170 mm
OSI180153 205 mm



LOWMAN-GERSTER
OSI180154
210 mm



LOWMAN-HOGLUNG
OSI190822
175 mm

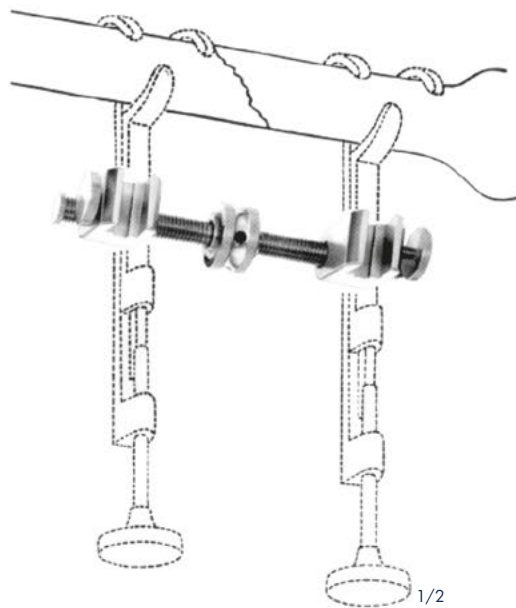

GERSTER
OSI180151
Traction bar for OSI180151 - OSI190822

Synovectomy - Rongeurs, Bone Rongeurs



OSI190823

OSI190824

OSI190823 - OSI190824

Synovectomy rongeur
Width of jaws 1.2 mm
130 mm



OSI190825

OSI190826

OSI190825 - OSI190826

Synovectomy rongeur
Width of jaws 2.0 mm
130 mm



STELLBRINK

OSI190541

Synovectomy rongeur
175 mm



STELLBRINK

OSI190542

Synovectomy rongeur
170 mm



OSI190827

145 mm



LUER-FRIEDMANN

OSI190828

145 mm



OSI190829

140 mm



LUER

OSI190560

150 mm

Bone Rongeurs



LUER
OSI190562
155 mm



BLUMENTHAL
OSI190555
155 mm



BLUMENTHAL
OSI190556
150 mm

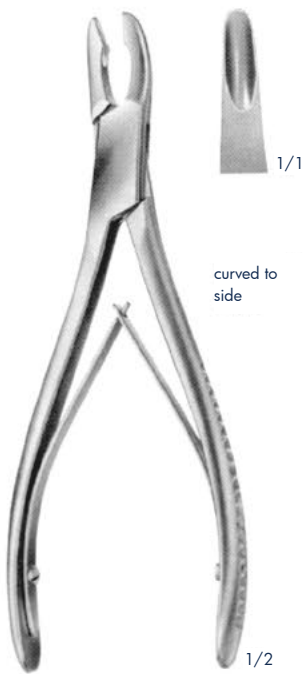

HAKANSSON
OSI190830
170 mm



JANSEN
OSI190551 - OSI190552
175 mm

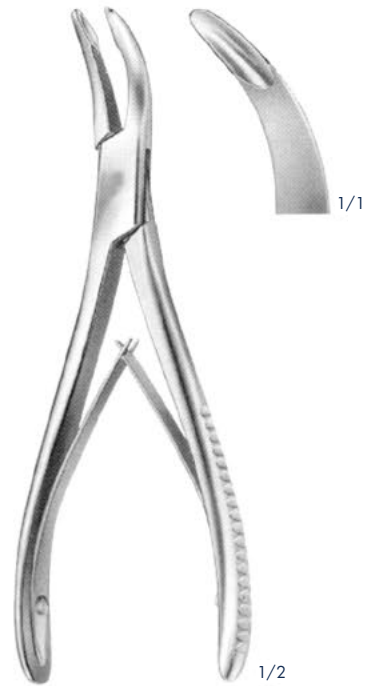

BANE-HARTMANN
OSI190550
175 mm

Bone Rongeurs



ALEXANDER
OSI190832
140 mm

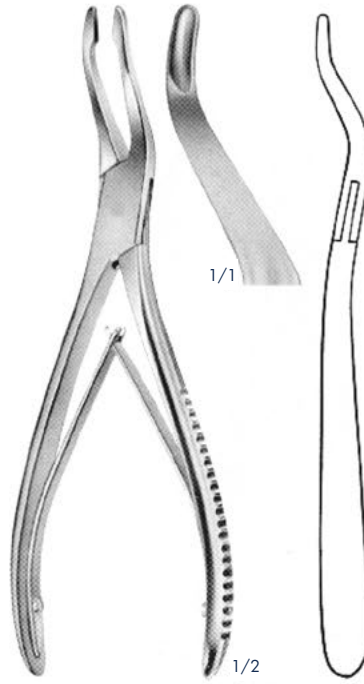

JANSEN
OSI190833
190 mm

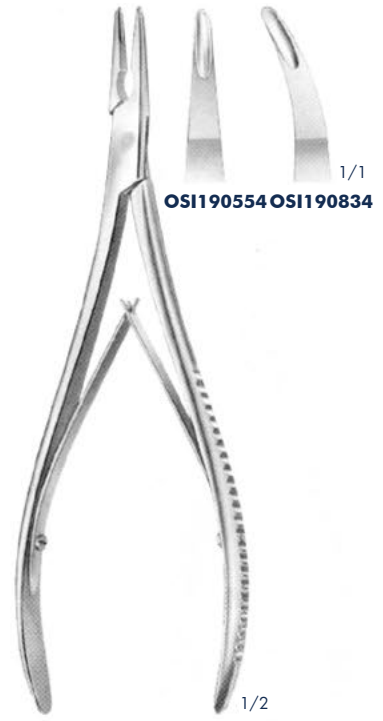

LEMPERT
OSI190554 - OSI190834
200 mm



BEYER
OSI190835
180 mm



MEAD
OSI190548
165 mm



MEAD
OSI190549
165 mm

Bone Rongeurs



LUER
OS1190558 - OS1190559
 175 mm



LUER
OS1190836
 180 mm



LUER
OS1190837
 180 mm

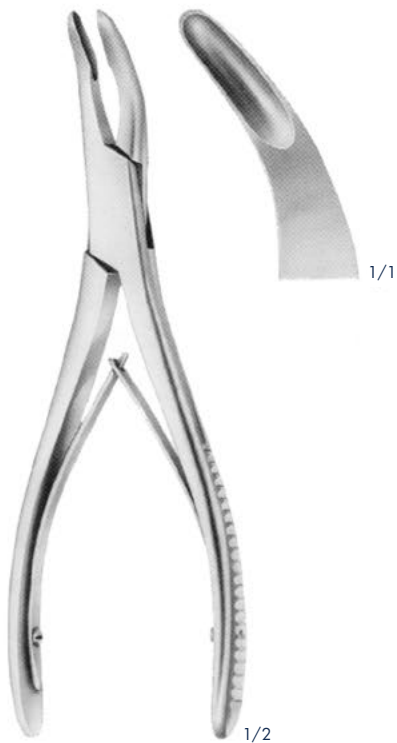

OLIVECRONA
OS1190838
 205 mm



GULEKE
OS1190839
 205 mm



TROTTER
OS1190840
 205 mm

Bone Rongeurs

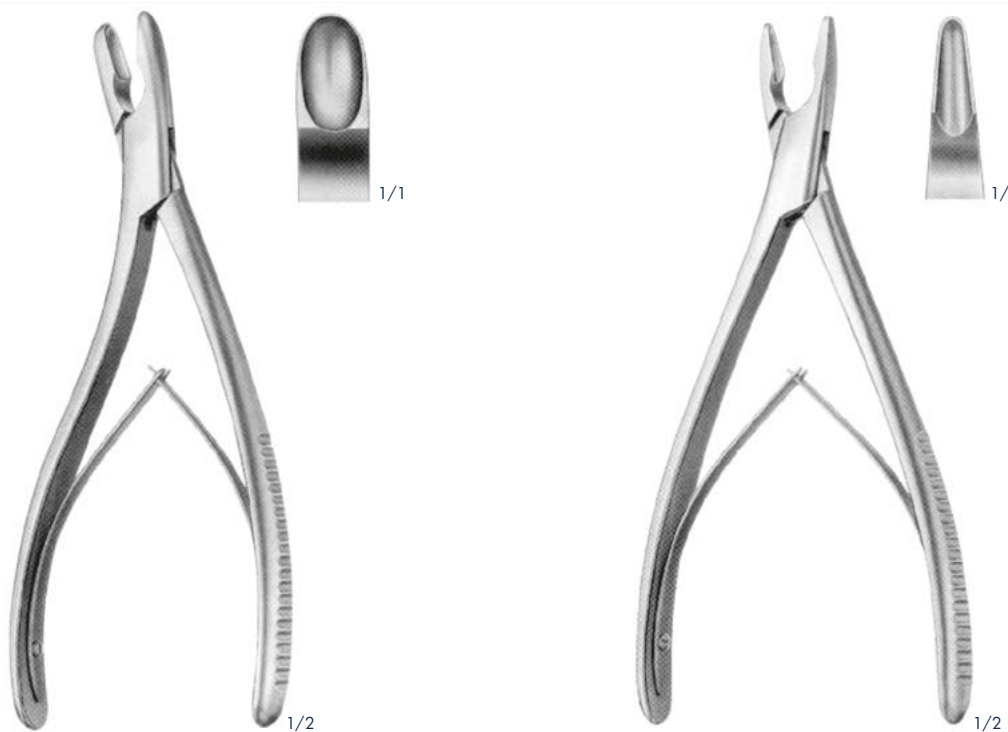

NORTHFIELD
OSI190841
210 mm

PENNYBACKER
OSI190842
205 mm



WILMS
OSI190843
210 mm

Bone Rongeurs



BÖHLER
OSI190563 - OSI190564
155 mm



MAYFIELD
OSI190567
175 mm



MARQUARDT
OSI190568
200 mm



OSI190565 - OSI190566
180 mm



BEYER
OSI190565

ZAUFAL JANSEN
OSI190566



RUSKIN
OSI190569
190 mm



RÖTTGEN-RUSKIN
OSI190570
240 mm

Bone Rongeurs

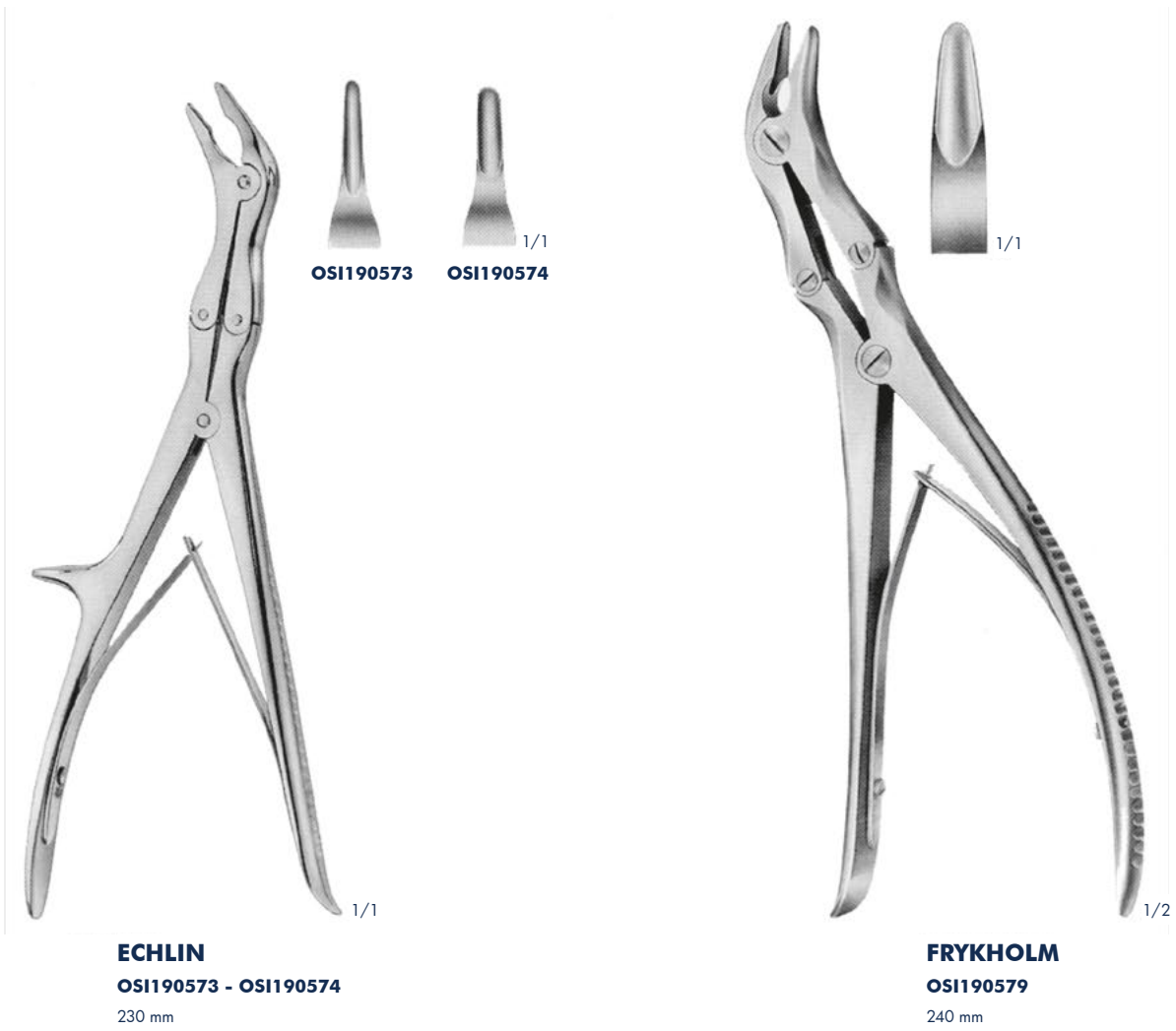

Bone Rongeurs



STILLE
OSI190572
235 mm



LEKSELL-STILLE
OSI190578
240 mm



STILLE-RUSKIN
OSI190576
240 mm

Bone Rongeurs

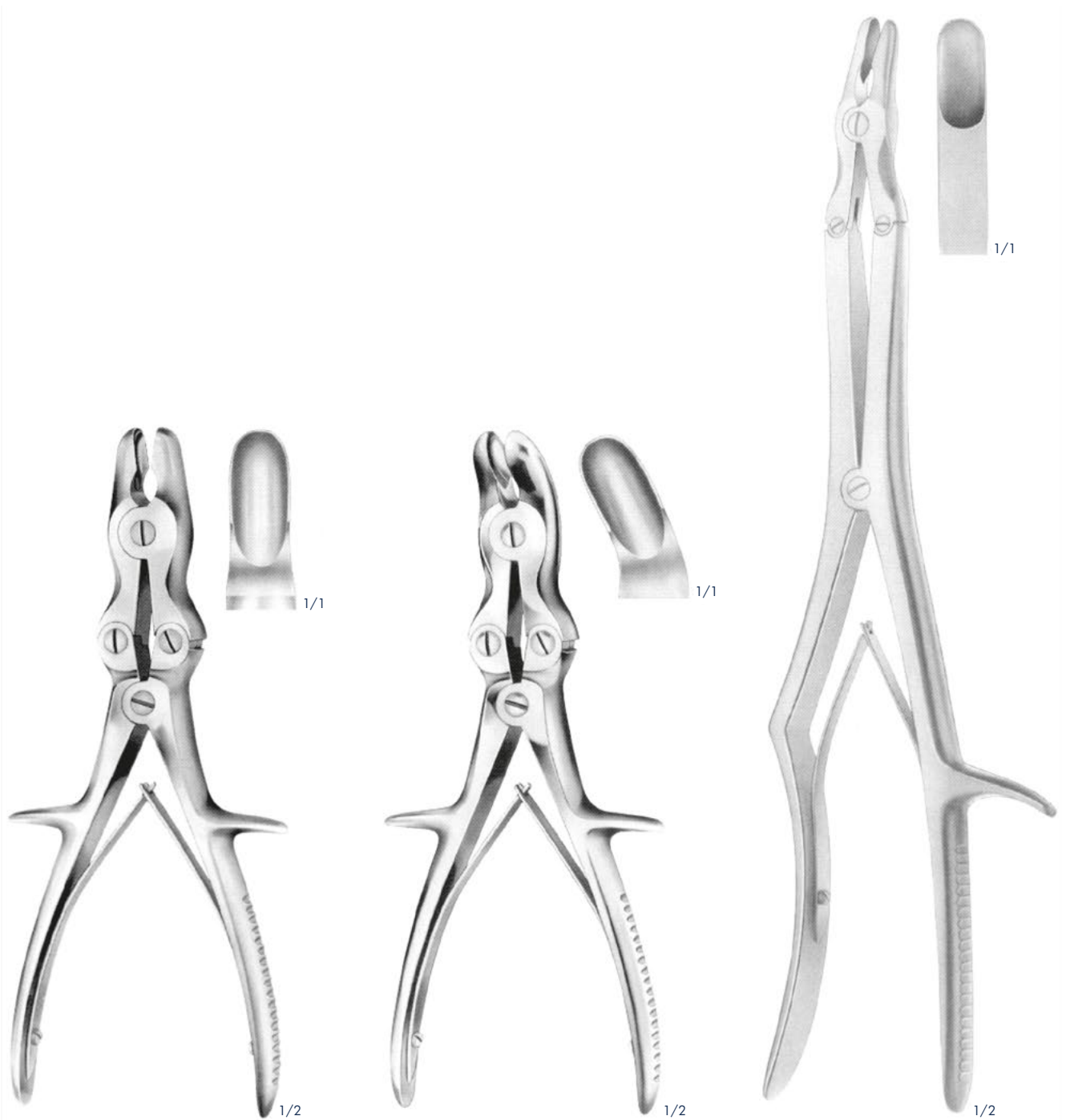

LUER-STILLE

OSI190580

225 mm

LUER-STILLE

OSI190581

225 mm

SYPERT

OSI190844

360 mm

Bone Rongeurs



LUER-STILLE
OSI190585
270 mm

1/2

1/1



SEMB
OSI190571
240 mm

1/2

1/1

Bone Rongeurs



MARKWALDER
OSI190598
190 mm

SAUERBRUCH-CORYLLOS
OSI190587 - OSI190586
310 mm

Bone Cutting Forceps

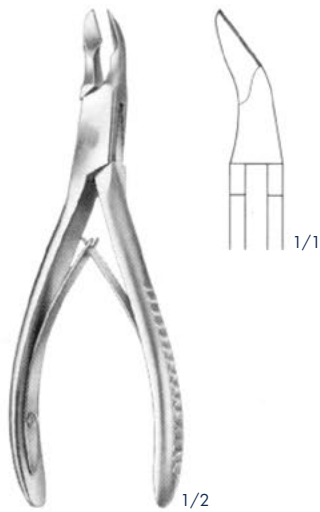

OS1190845
130 mm

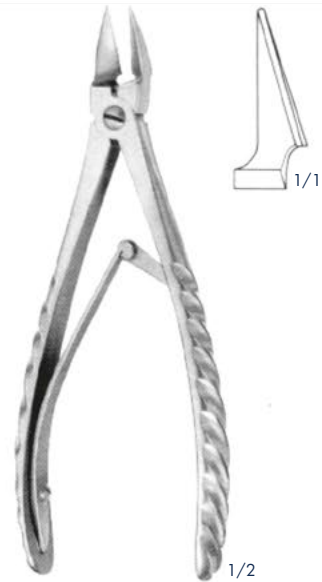

STAMM
OS1190846
150 mm

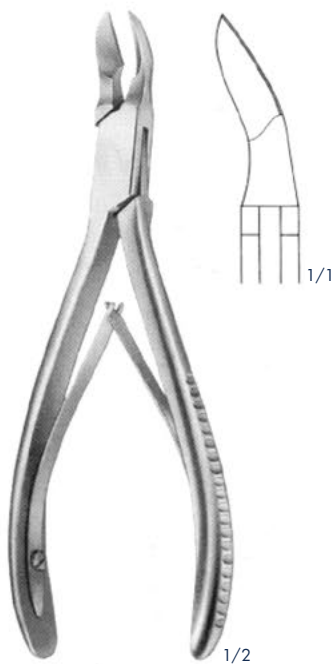

OS1190847
170 mm

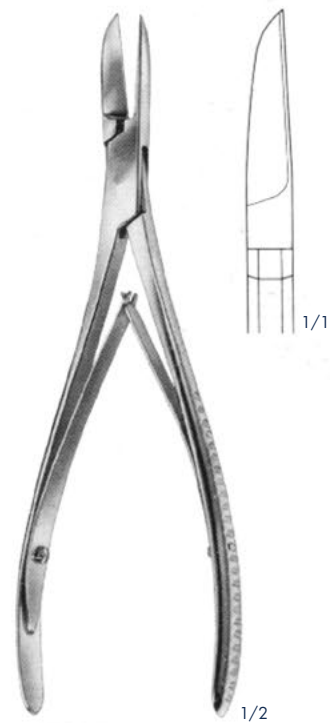

KAZANJIAN
OS1190589
185 mm

Bone Cutting Forceps



OSI190590
140 mm



OSI190591
170 mm



OSI190592
200 mm



OSI190593
220 mm



LISTON
OSI190590 - OSI190593



OSI190595
170 mm

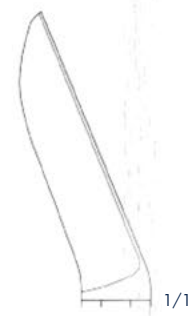

OSI190596
200 mm



OSI190597
220 mm



LISTON
OSI190595 - OSI190597

Bone Cutting Forceps

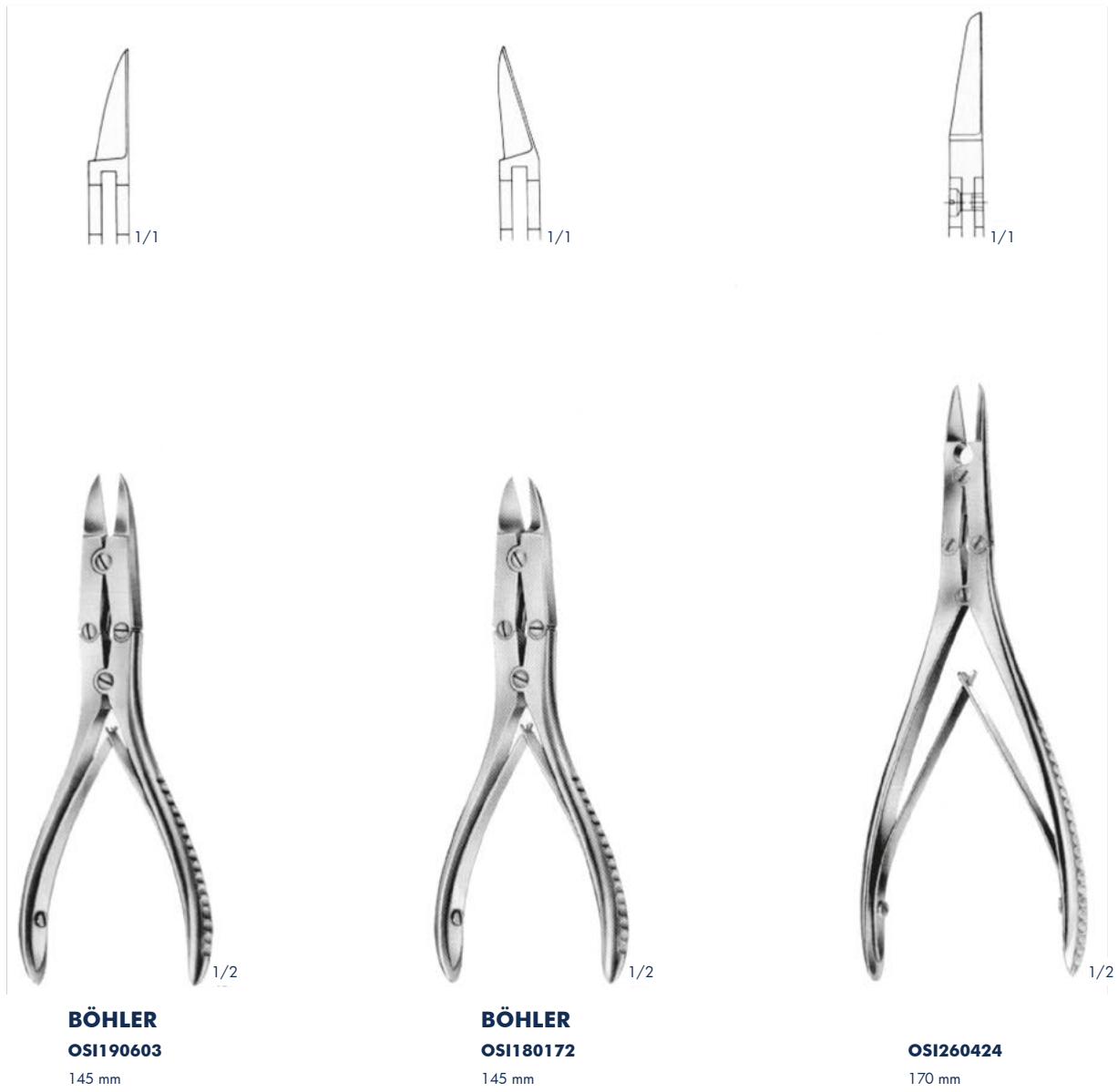

Bone Cutting Forceps

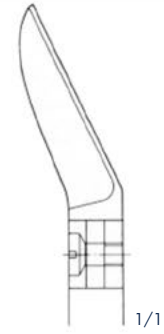
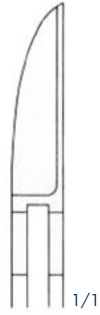
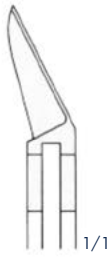

MC INDOE
OSI190848
175 mm



RUSKIN-LISTON
OSI190606
190 mm



RUSKIN-LISTON
OSI190607
190 mm

Bone Cutting Forceps

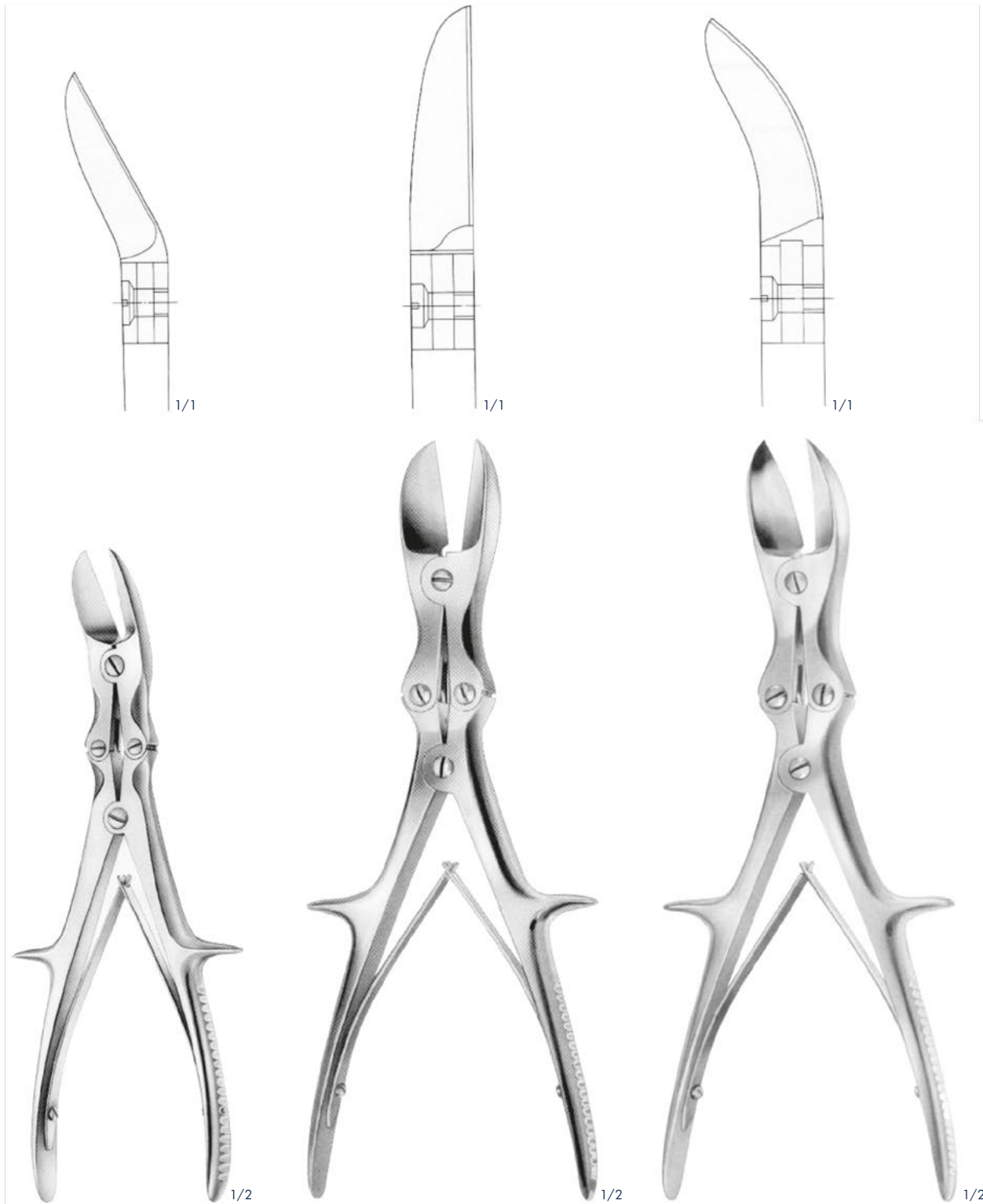

LISTON
OSI190610
240 mm
curved on flat

LISTON
OSI190609
280 mm
straight

LISTON
OSI190611
280 mm
curved on flat

Bone Cutting Forceps

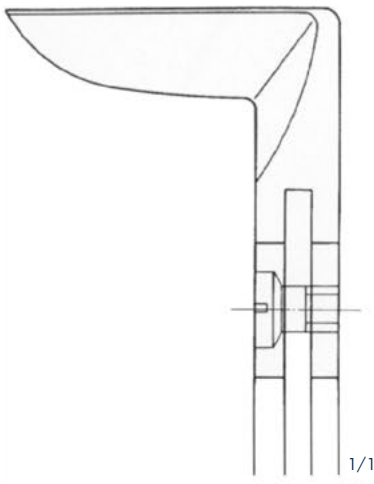

LISTON - STILLE
OS1190608
265 mm

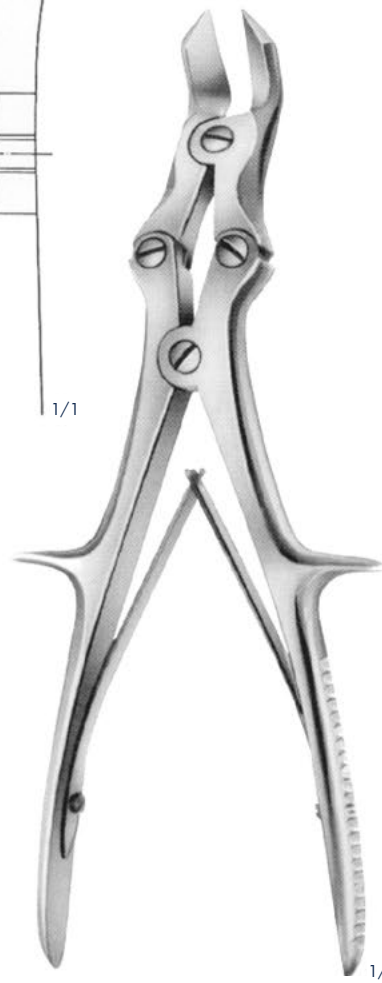
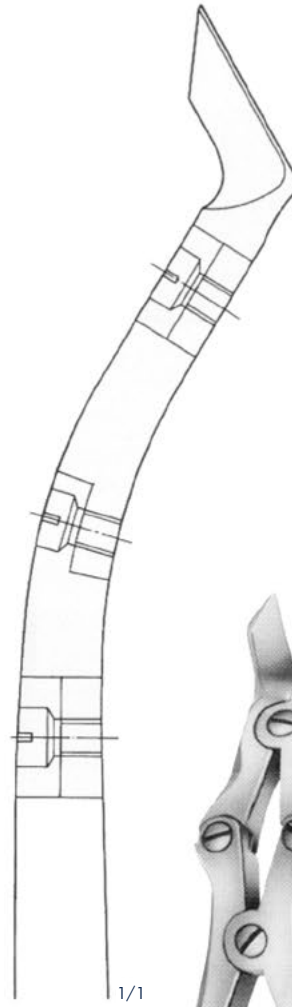

**LISTON - KEY - HORSLEY
(TUDOR EDWARDS)**
OS1190612
255 mm

Meniscus- and Cartilage Forceps

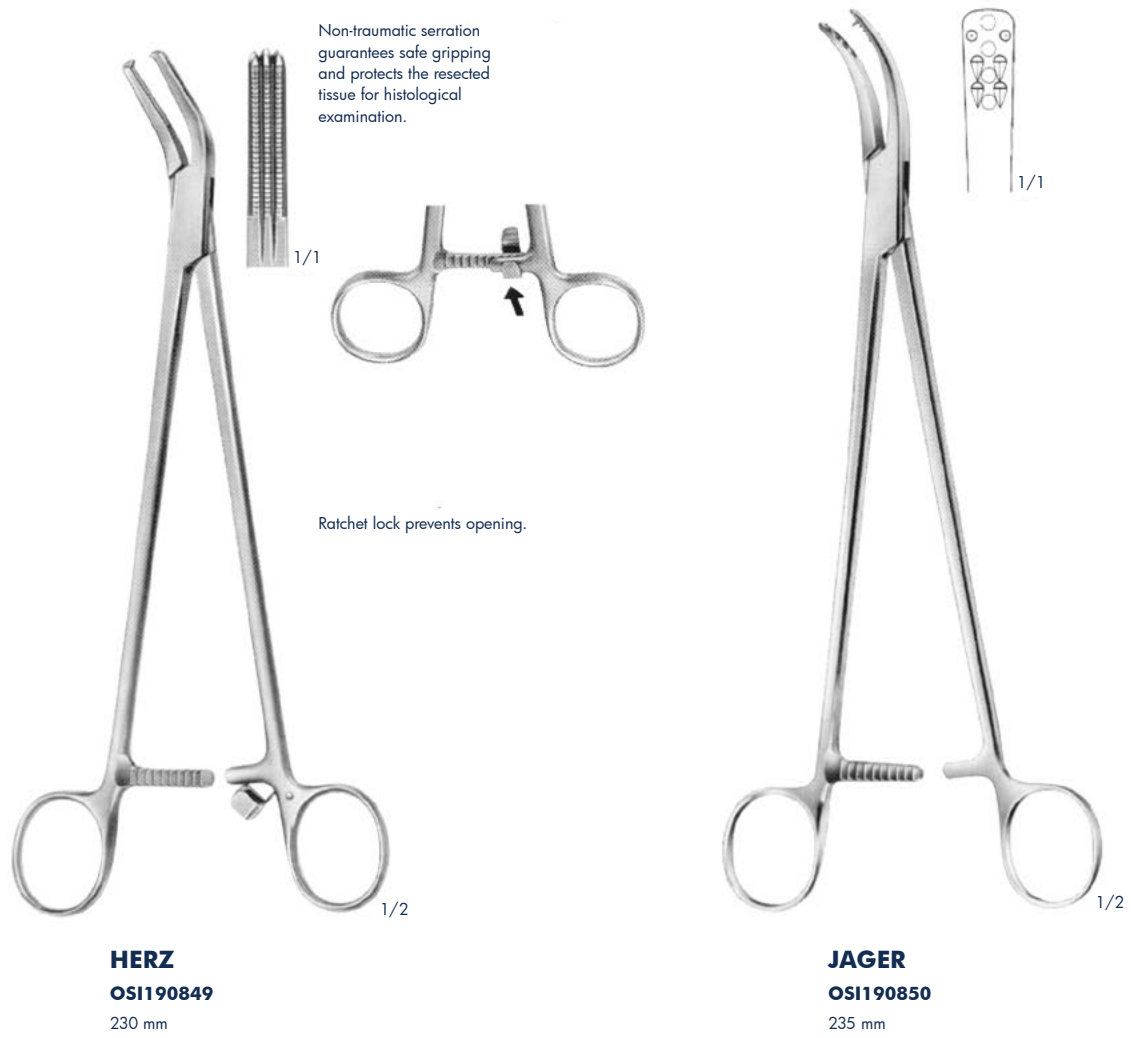

Meniscus- and Cartilage Forceps

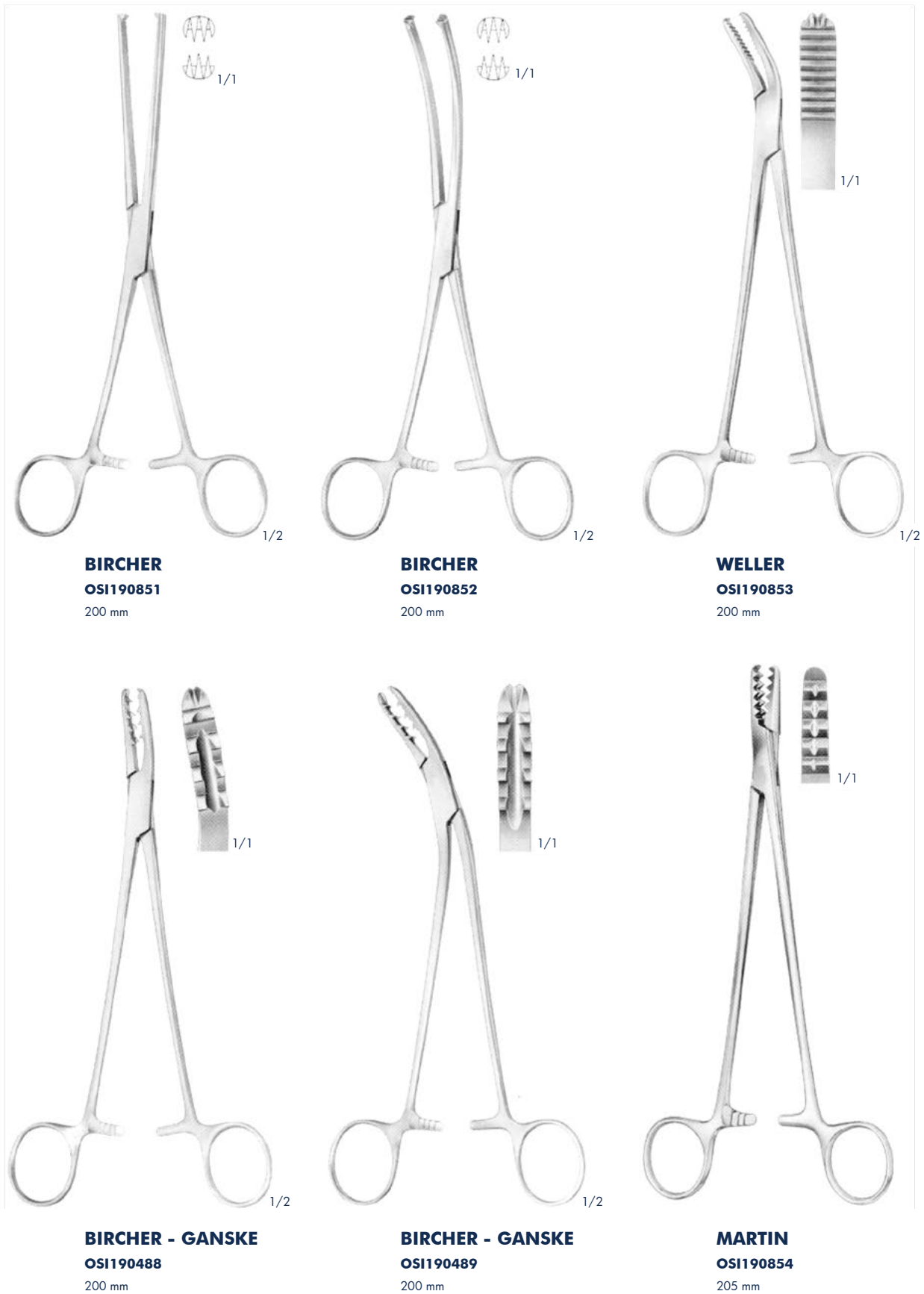

Meniscus Knives

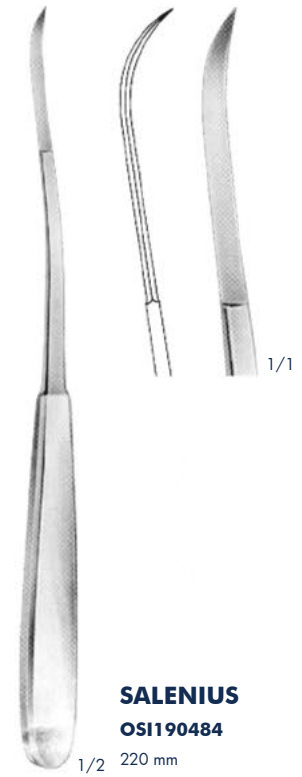
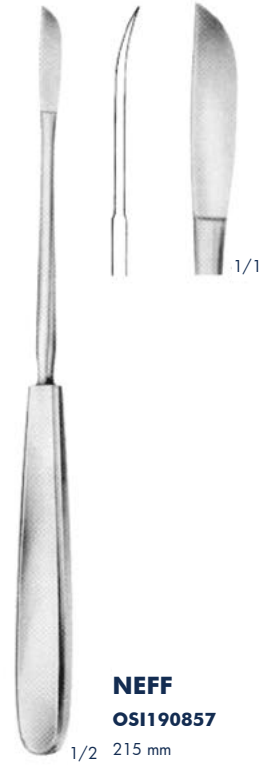
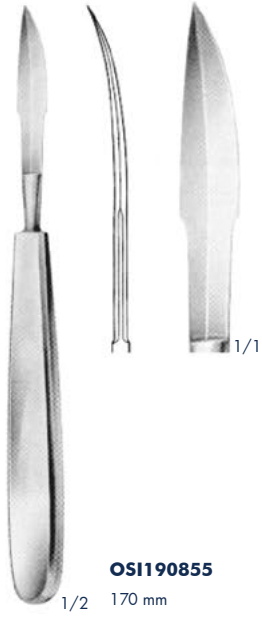

Meniscus Knives



Retractors and Knee Retractors

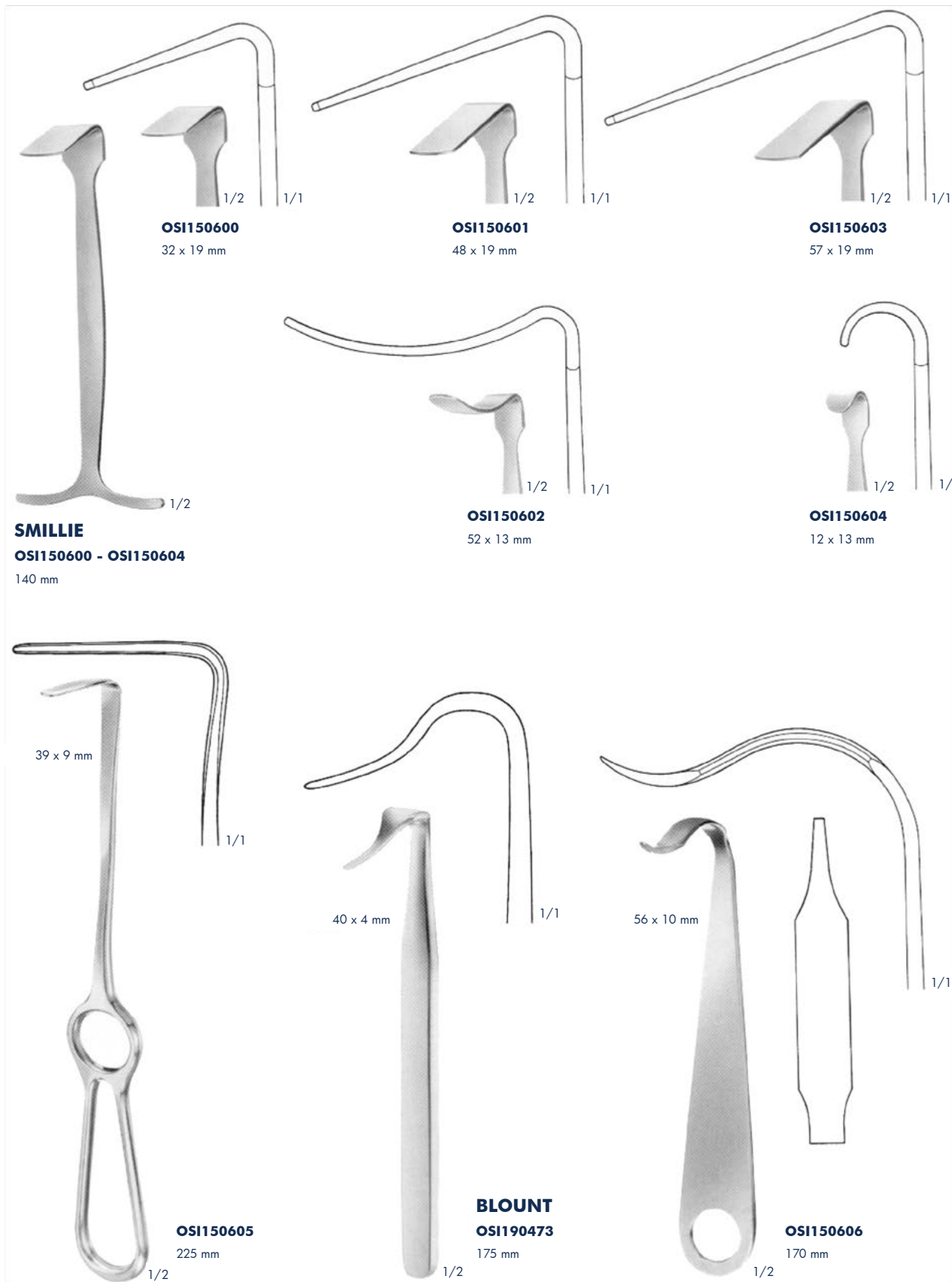

Hand Drills, Twist Drills



BUNNELL

OS1180316

Small hand drill, cannulated for KIRSCHNER wires, with 3-jaw chuck, to fit any size of shanks up to 4.0 mm diameter
160 mm



OS1180317 hand drill, stainless, with 3-jaw chuck, to fit any size of shanks up to 6.35 mm diameter, no key needed. Cannulated spindle to fit KIRSCHNER wire drills. With stop device, for locking the spindle and crank when fitting and changing drills.
260 mm

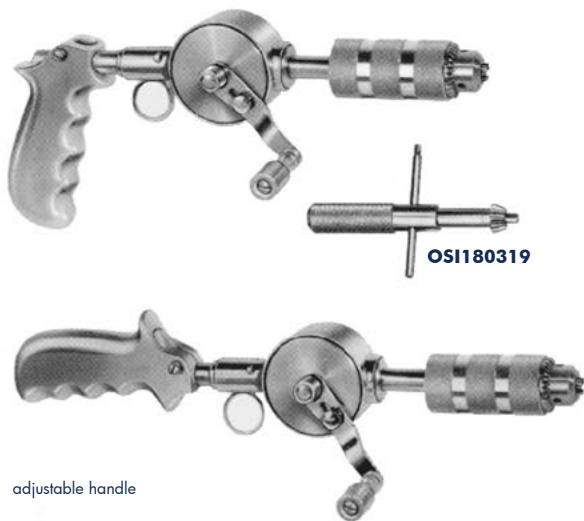

adjustable handle

OS1180318 hand drill, stainless, as above, but equipped with an original "Jacobs Cuck" and key

OS1180319 Can be used with or without the key.
280 mm



Ø	Schaft	mm	Schaft	mm
1,0 mm				
1,5 mm				
2,0 mm				
2,5 mm	OS1180320	175/135	OS1180325	100/50
2,8 mm			OS1180326	100/50
3,0 mm			OS1180327	100/60
3,2 mm			OS1180328	100/60
3,5 mm	OS1180321	210/170	OS1180329	100/60
4,0 mm			OS1180330	110/70
4,5 mm	OS1180322	210/170	OS1180331	150/80
5,0 mm			OS1180332	160/90
6,0 mm			OS1180333	160/90
			Total Length	Usable length

Bone Drills



ESMARCH

OSI180334

Bone drill with 2 drill points

OSI180335 and **OSI180336**

200 mm



CHAMPIONNIERE

OSI180337

170 mm

Bone drill

Awis, Reamers



OSI180338
Reamer (Awl)
150 mm

1/2



OSI180339
Reamer (Awl)
180 mm

1/2

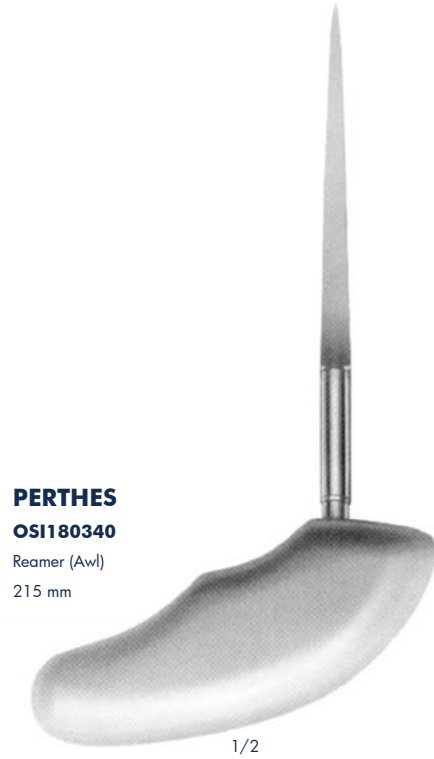

PERTHES
OSI180340
Reamer (Awl)
215 mm

1/2



OBWEGESER
OSI180341
230 mm

1/2



1/1

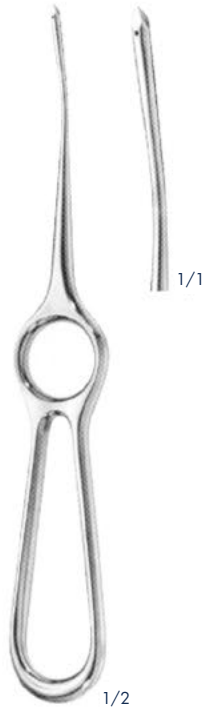

OBWEGESER
OSI180342
195 mm

1/2



1/1



BRUNNER
OSI170250
300 mm

1/2



1/1



OSI170421
230 mm

1/2

biegsam
malleable

1/1

Biopsy Instruments

Can also be used for removal of broken bone screws.



OSI180343
inside-diam. 3.9 mm
outside-diam. 5 mm



OSI180344
inside-diam. 6.4 mm
outside-diam. 8 mm



OSI180343 - OSI180344
Hollow mills
(bone biopsy trephine)
170 mm

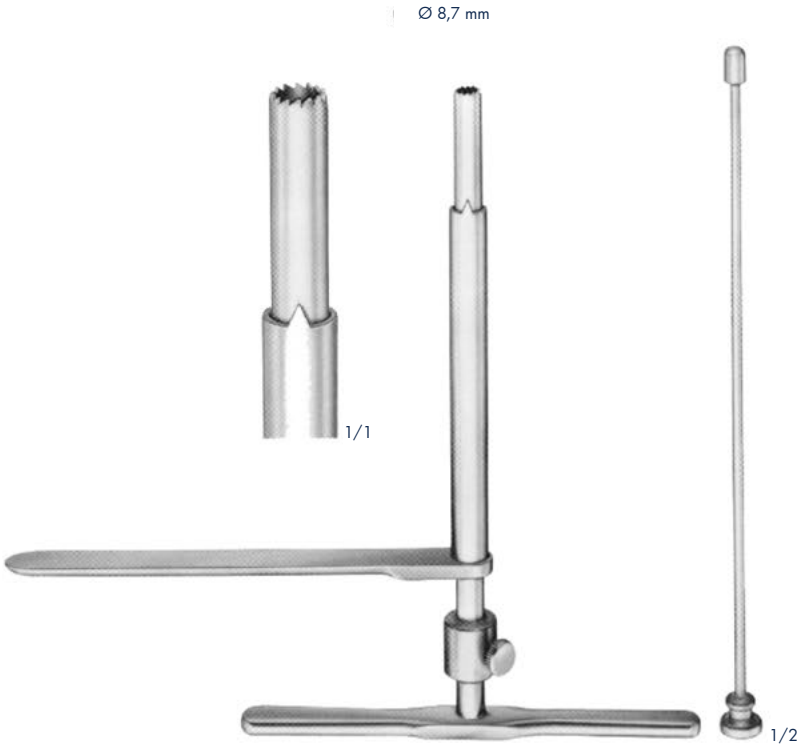

OSI180345
Bone biopsy trephine
195 mm

PUHL Instruments for Bone Biopsy



1/2

OSI180346 6 mm Ø/diam.
OSI180347 9 mm Ø/diam.
OSI180348 12 mm Ø/diam.
 Hollow mills for bone biopsy
 110 mm



1/2

OSI180349 6 mm Ø/diam.
OSI180350 9 mm Ø/diam.
OSI180351 12 mm Ø/diam.
 Hollow mills for bone biopsy
 150 mm



1/2

OSI180352
 Handle
 For **OSI180346 - OSI180351**



1/2

OSI180353
 Adapter
 Adapter for **OSI180346 - OSI180351**
 with triangular shaft, to be used with
 three-jaw chuck



1/2

OSI180354
 Tamper

Wire Extension

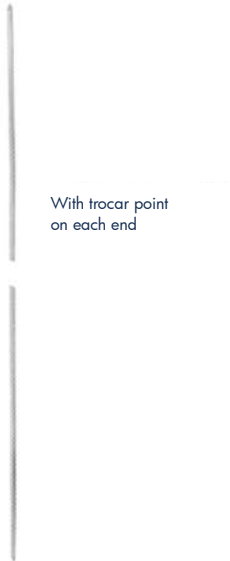

KIRSCHNER
OSI180355 - OSI180371



KIRSCHNER
OSI180372 - OSI180382
with trocar point
310 mm



OSI180383 - OSI180392
with trocar point
310 mm

	102 mm	127 mm	152 mm	229 mm	305 mm
Ø/diam.	4"	5"	6"	9"	12"
0,8 mm	OSI180355	OSI180356			
0,9 mm	OSI180357	OSI180358	OSI180359	OSI180360	OSI180361
1,0 mm					
1,1 mm	OSI180362	OSI180363	OSI180364	OSI180365	OSI180366
1,2 mm					
1,4 mm					
1,5 mm					
1,6 mm	OSI180367	OSI180368	OSI180369	OSI180370	OSI180371
1,7 mm					
1,8 mm					
2,0 mm					
2,2 mm					
2,5 mm					
3,0 mm					

OSI180372

OSI180373

OSI180374

OSI180375

OSI180376

OSI180377

OSI180378

OSI180379

OSI180380

OSI180381

OSI180382

OSI180384

OSI180384

OSI180385

OSI180386

OSI180387

OSI180388

OSI180389

OSI180390

OSI180391

OSI180392

available in packages of 10 pieces
Sales unit : PZ

Wire Extension



with round shaft
OSI180393
OSI180394
 with trocar point
 70 mm



with round shaft
OSI180395
OSI180405
 with trocar point
 150 mm



with round shaft
OSI180406
OSI180417
 with trocar point
 150 mm

Ø / diam.

- 0,8 mm **OSI180393**
- 1,0 mm **OSI180394**
- 1,2 mm
- 1,4 mm
- 1,5 mm
- 1,6 mm
- 1,7 mm
- 1,8 mm
- 2,0 mm
- 2,2 mm
- 2,5 mm
- 3,0 mm

- OSI180395**
- OSI180396**
- OSI180397**
- OSI180398**
- OSI180399**
- OSI180400**
- OSI180401**
- OSI180402**
- OSI180403**
- OSI180404**
- OSI180405**

- OSI180406**
- OSI180407**
- OSI180408**
- OSI180409**
- OSI180410**
- OSI180411**
- OSI180412**
- OSI180413**
- OSI180414**
- OSI180415**
- OSI180416**
- OSI180417**

available in packages of 10 pieces
 Sales unit : PZ

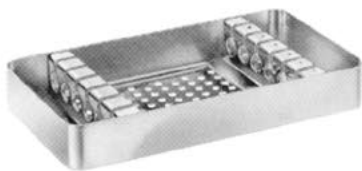

OSI180418
 170 x 92 x 25 mm

Bending iron for boring wires

can be sterilized in a steam sterilizer up to 143°C (3 bar)

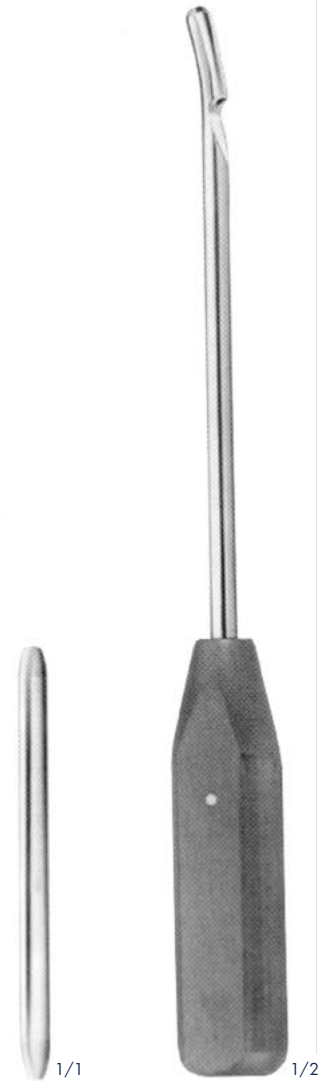

OSI180419
 120 mm
 bis Ø 2.7 mm
 up to
 2.7 mm diam.

WAGNER
OSI180420
 300 mm
 bis Ø 3.0 mm
 up to
 3.0 mm diam.

Wire Extension

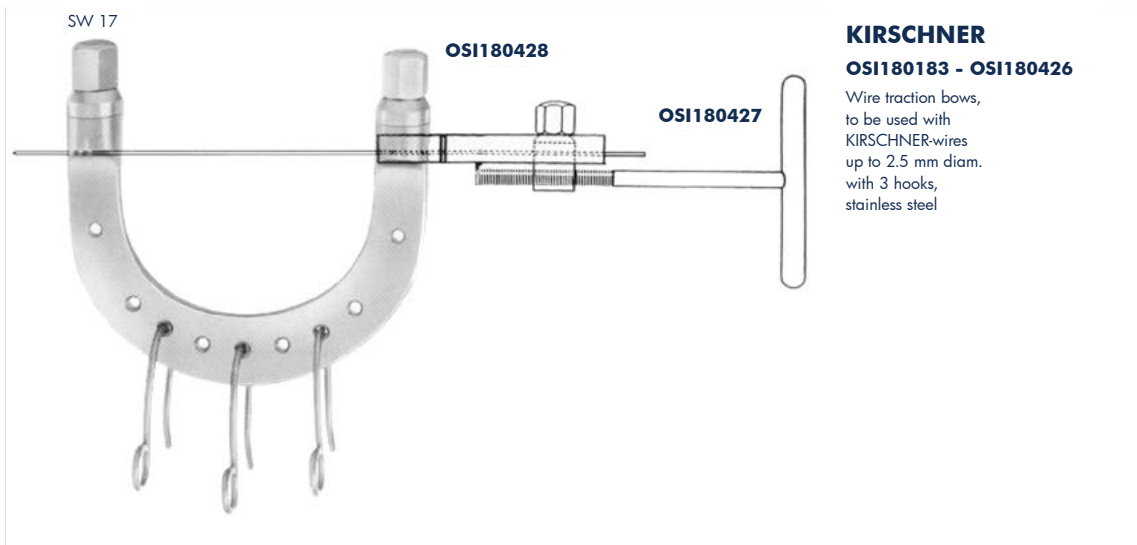

KIRSCHNER

OSI180183 - OSI180426

Wire traction bows, to be used with KIRSCHNER-wires up to 2.5 mm diam. with 3 hooks, stainless steel

inside dimensions

	width	depth
OSI180183	200 mm	155 mm
OSI180421	155 mm	155 mm
OSI180422	135 mm	130 mm
OSI180423	120 mm	120 mm
OSI180424	105 mm	100 mm
OSI180425	95 mm	110 mm
OSI180426	95 mm	70 mm

for the hip
for the femur
for the knee
for the knee
for the knee
for the calcaneus
for the arm and elbow



OSI180429



OSI180427
Wire tightener, with clamping jaws



OSI180186
Traction hook only, large size



OSI180187
Traction hook only, small size



OSI180428
Fixation clamp, to secure clamping jaw of **OSI180427** stainless steel

Wire Extension

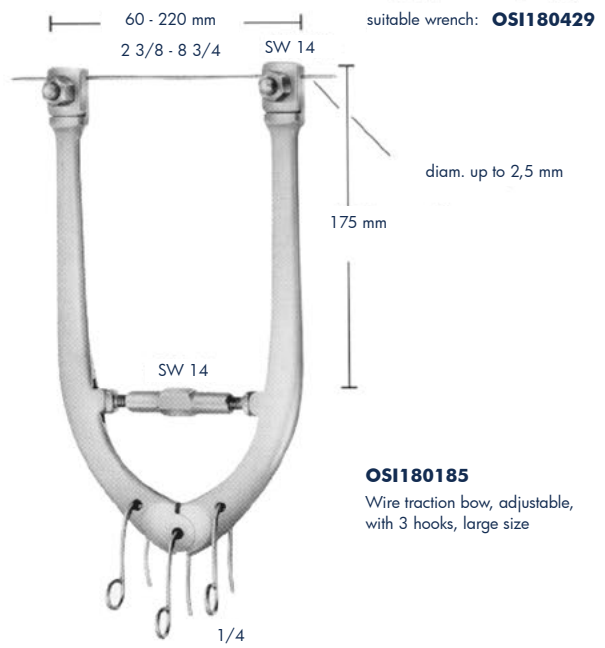
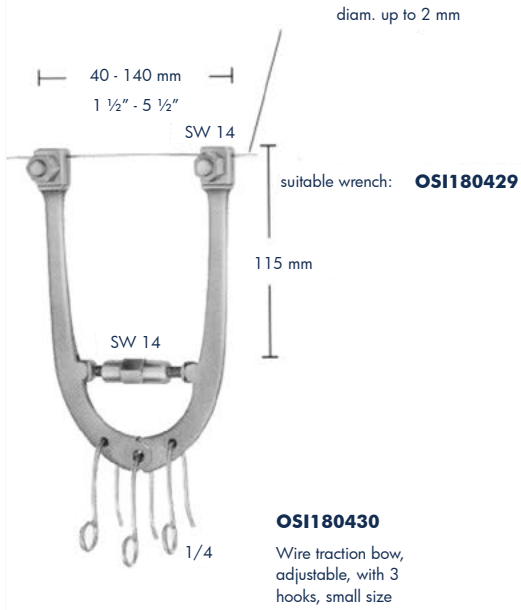

OS1180431
Fixation disc, slotted



OS1180433
Fixation disc, slotted



OS1180432
idem, aluminium, transparent to X-rays



OS1180434
Screw driver, for above fixations discs



Traction Bows, Distractor



BÖHLER traction bows,
to be used with
STEINMANN pins,
4 mm diam.

BÖHLER traction bows,
to be used with
STEINMANN pins,
5 mm diam.

inside width for

OSI180435

with pin **OSI180448**

16 x 9 cm

OSI180436

without pin

OSI180441

without pin

6 1/4" x 3 1/2" arm

OSI180437

with pin **OSI180450**

21 x 11 cm

OSI180438

without pin

OSI180442

without pin

8 1/4" x 4 3/8" femur and knee

OSI180439

with pin **OSI180452**

21 x 15 cm

OSI180440

without pin

8 1/4" x 6" femur and knee



10 - 40 mm

OSI190802

Small distractor
as a repositioning device for
distraction and compression of small bones,
for wires with 3.0 mm diam.

STEINMANN Pins



STEINMANN

OSI180444 - OSI180459

triangular shaft ended and trocar point

Ø diam.	4.0 mm	5.0 mm
length		
80 mm	OSI180444	
100 mm	OSI180445	
120 mm	OSI180446	
140 mm	OSI180447	
150 mm	OSI180448	OSI180455
160 mm	OSI180449	
180 mm	OSI180450	OSI180456
200 mm	OSI180451	OSI180457
210 mm	OSI180452	
250 mm	OSI180453	OSI180458
300 mm		OSI180459



1/1

OSI180460

Protection cap

for 4.0 mm **STEINMANN** Pins



1/1

OSI180461

Protection cap

for 5.0 mm **STEINMANN** Pins

Drilling Chucks



OS1180462

Drilling chuck, cannulated for shanks from 0.8 mm - 2.0 mm diam.
150 mm



OS1180463

Drilling chuck, cannulated, for shanks up to 4.5 mm diam., with key **OS1180578**
140 mm

Chuck jaws made of material used for implants



OS1180464

Drilling chuck, cannulated, for shanks up to 6.35 mm diam. , to be tightened by hand
100 mm



OS1180465

Drilling chuck, cannulated, for shanks up to 4.5 mm diam. and for triangular shaft width across flats 4.7 mm (SCHANZ screws, STEINMANN pins,) with key **OS1180578**



OS1180466

Drilling chuck, cannulated, for shanks up to 6.35 mm diam. , with key **OS1180319**
160 mm

Cerclage Instruments



OSI180579 - OSI180589

Wire, soft, tissue compatible, in coils of 10 m
Material used for implants: stainless steel acc.

Ø / diam. mm	0,2	0,3	0,4	0,5	0,6	0,7	0,8	0,9	1,0	1,2	1,5
	OSI180579	OSI180580	OSI180581	OSI180582	OSI180583	OSI180584	OSI180585	OSI180586	OSI180587	OSI180588	OSI180589
Gauge	35	30	27	25	23	22	21	20	19	18	17



ORMROD-SCHMITT

OSI180590 Material used for implants: stainless steel Acc.

Ligature disc



1/2



Movable tip made of material used for implants.
While twisting the movable head remains stable, therefore the wire will not slip off.

LOUTE

OSI180467

Wire tightener, improved pattern, with movable tip, for wires up to 1.0 mm diam.
220 mm

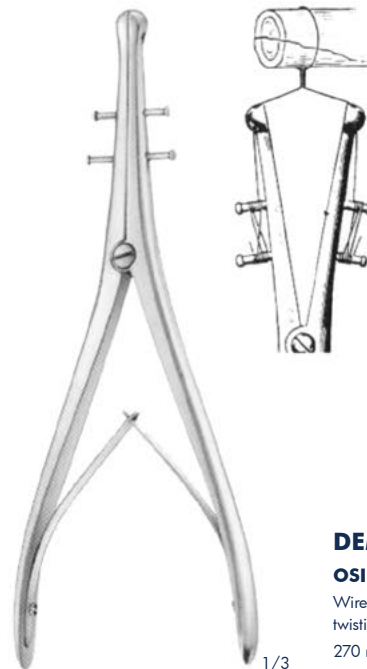

1/3

DEMEL

OSI180468

Wire tightening- and twisting forceps
270 mm

Cerclage Instruments

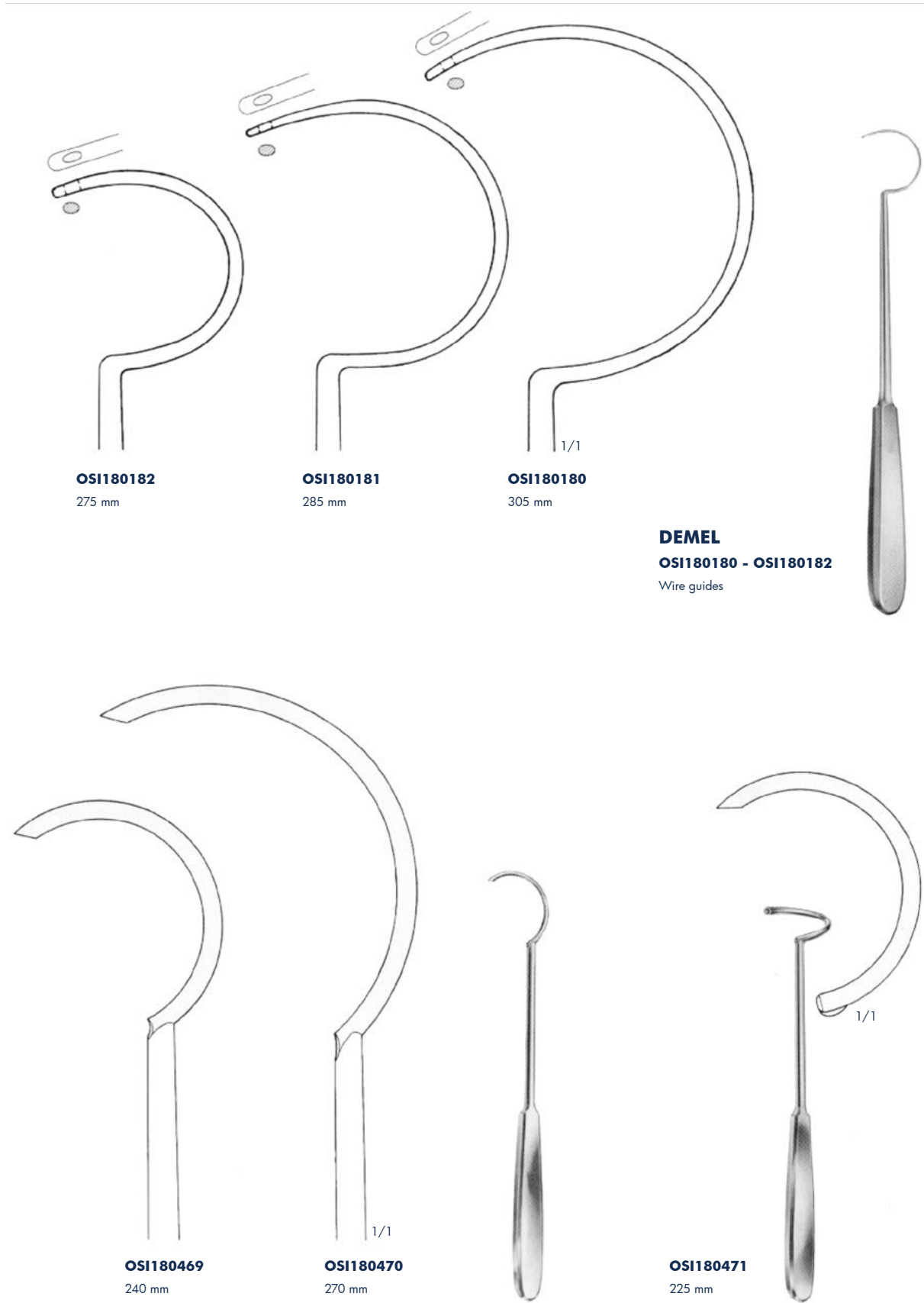

Wire Holding Forceps, Wire Tightening Pliers, Flat-nosed Pliers

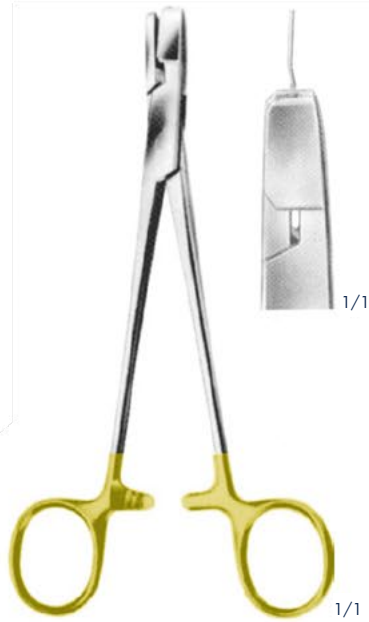

OSI180472
Holding forceps for cerclage wire, with lateral jaws to avoid wire slipping off
170 mm

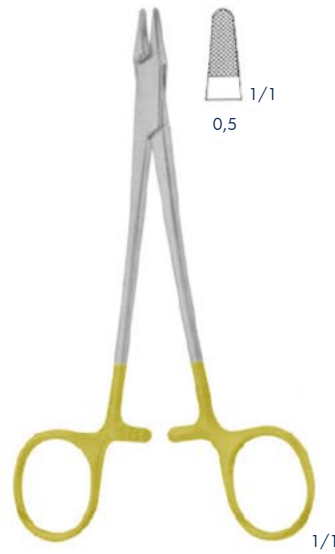

OSI170340
Wire tightening pliers, Ligature pliers
150 mm



OSI170341
Wire tightening pliers, Ligature pliers
150 mm



BAUMGARTNER
OSI170342
Wire twister, Ligature forceps
200 mm

Wire Tightening Pliers, Wire Cutting Scissors

with hard metal inserts



Wire Holding Forceps, Wire Tightening Pliers, Flat-nosed Pliers



OSI180474
with serrated jaws
140 mm

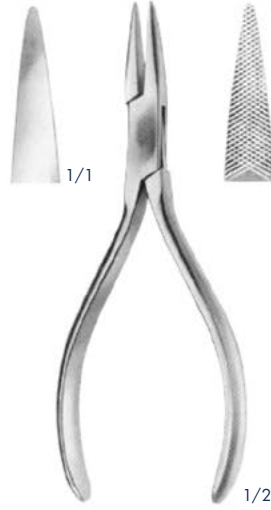

OSI180475
eine Seite glatt
one jaw serrated
140 mm



OSI180169

OSI180170

OSI180169
with serrated jaws
OSI180170
with longitudinal and
transversal grooves
170 mm



OSI180155
190 mm

Wire Holding Forceps, Flat-nosed Pliers Pliers for bending and cutting wires

Exposure of grown-in wire ends is possible due to milling ends of the jaws. Profiles of the jaws guarantee absolutely safe gripping of the wire ends.



OSI180476
130 mm

OSI180477
180 mm

OSI180476 - OSI180477
Extraction pliers for boring wires

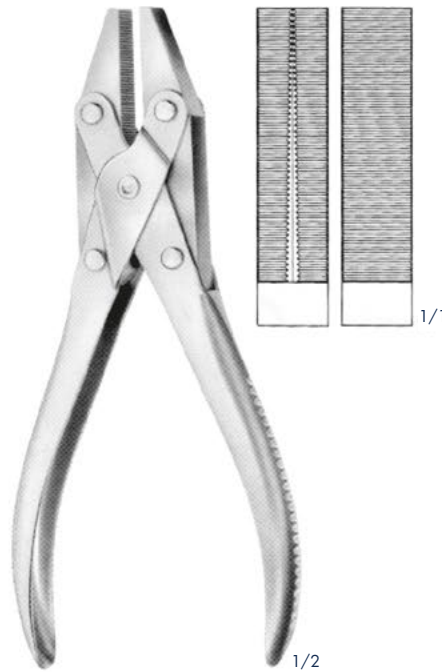

OSI180157
Flat-nosed pliers, parallel
185 mm

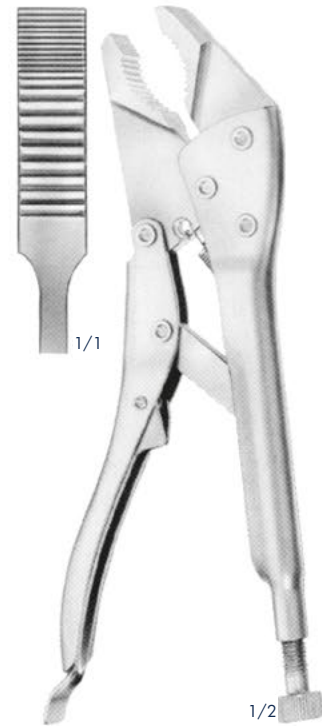

OSI180158
Vise grip
200 mm



Round pliers
180 mm

OSI180478 145 mm
OSI180163 180 mm
OSI180164 180 mm

Extraction pliers for wires



OSI180479
Bending pliers for wires
up to 1.8 mm diam.

Wire Cutters and Wire Cutting Scissors



1/1

1/2 specially hardened cutting edges

ANGLE

OSI180480

130 mm

for soft wire up to diam. 0,5 mm
for hard wire up to diam. 0,3 mm

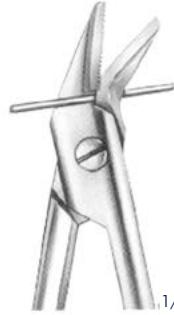

1/1

1/2

OSI110412

120 mm

1,2 mm
0,8 mm

OSI110449

120 mm

1,2 mm
0,8 mm



1/1

HARVEY

OSI110710

125 mm

0,4 mm
0,3 mm



1/1

1/2

OSI180482

150 mm

for soft wire up to diam. 1,5 mm
for hard wire up to diam. 1,0 mm



1/1

1/2

OSI180483

160 mm

1,5 mm
1,2 mm



1/1

specially hardened cutting edges

1/2

OSI180484

140 mm

1,5 mm
1,0 mm

Wire Cutting Pliers, Lateral Cutting Aciton



Wire Cutting Pliers, Lateral Cutting Aciton

OSI180473

Angled slender pattern for wire removal after sternum suture

170 mm

for soft wire up to diam.

for hard wire up to diam.

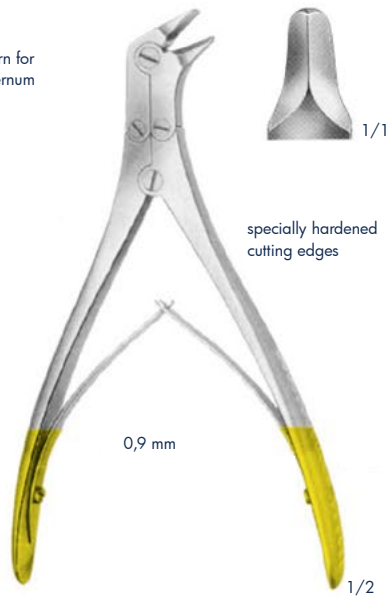

OSI180175

240 mm

with carbide cutting edges

2,0 mm

1,6 mm

1/2



OSI180487

Front and lateral cutting action

180 mm

for soft wire up to diam.

for hard wire up to diam.



REILL

OSI180488

175 mm

specially hardened cutting edges

2,0 mm

1,6 mm

1/2

for cutting off wires close to the bone

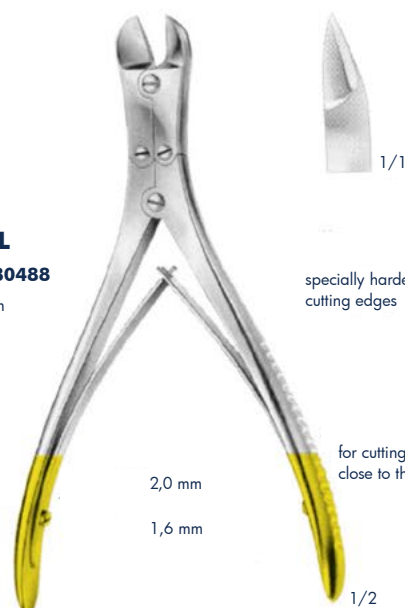

Wire Cutting Pliers, Front Cutting Aciton



specially hardened cutting edges

OSI180489
145 mm

for soft wire up to diam.
for hard wire up to diam.

1,5 mm
1,0 mm



specially hardened cutting edges

OSI180174
145 mm

2,0 mm
1,5 mm



specially hardened cutting edges

OSI180490
220 mm

for soft wire up to diam.
for hard wire up to diam.

3,5 mm
2,5 mm

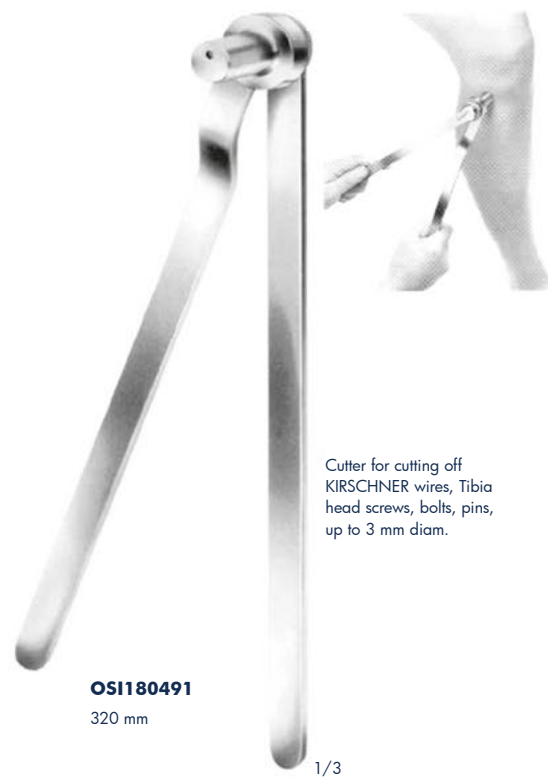

Cutter for cutting off KIRSCHNER wires, Tibia head screws, bolts, pins, up to 3 mm diam.

OSI180491
320 mm

3,0 mm
3,0 mm

Wire Cutting Pliers



OSI180492

Cutter for cutting off KIRSCHNER wires, Tibia head screws, bolts, pins, up to 6 mm diam.
470 mm

Finger Nail Instruments



OSI180493
Nail extracting forceps
135 mm



OSI180494
Nail extracting forceps
145 mm



OSI180495
Finger nail drill with 3 drill points

Drill points only



OSI180499
Nail splitting forceps
135 mm



SYSTRUNK
OSI110552
Scissors, for splitting finger nails
130 mm



OSI180503
Finger ring saw
150 mm

OSI180504

Spare blade

Plaster Instruments

Plaster Knives



with ebony handle

HOPKINS
OSI180500
1/2 200 mm



ESMARCH
OSI180501
1/2 180 mm

Plaster Saw



ENGEL
OSI180502
1/2 150 mm

Bandage- and First Aid Scissors



OSI110717 black
OSI110718 red
OSI110719 blue
OSI110720 yellow
OSI110721 orange
OSI110722 bright pink
145 mm



OSI110725 black
OSI110726 red
OSI110727 blue
OSI110728 yellow
OSI110729 orange
OSI110730 bright pink
180 mm

Plaster scissors

for small plaster dressings



Plaster Shears

Special features:
The construction of the open jaws avoids tiresome clogging by plaster remnants and allows furthermore an easy cleaning.
The shears do not glide off the plaster owing to the deep teething on the jaws.
The knives with hollow grinding have a better cutting ability and therefore less force is required.
The knives are guided by ball bearings.

open jaws



STILLE
OSI180509
260 mm



STILLE
OSI180510
360 mm

STILLE Plaster Shears

Blade with reinforced back



STILLE
OSI180108
230 mm



STILLE
OSI180110
370 mm



STILLE
OSI180511
240 mm

Plaster Spreader, Plaster Breakers



HENNIG
OSI180122
270 mm
1/3



MOD. USA
OSI180111
230 mm
1/3



with removable jaws

OSI180512
290 mm
1/3



WOLFF
OSI180112 180 mm
OSI180113 240 mm

Plaster breakers

Vacuum Curettes for Aspiration Lipectomy



BIEMER

- OSI160301** Ø 4 mm
- OSI160302** Ø 6 mm
- OSI160303** Ø 8 mm
- OSI160304** Ø 10 mm
- OSI160305** Ø 12 mm
- OSI160306** Ø 14 mm

Curettes for aspiration lipectomy, graduated, slightly curved

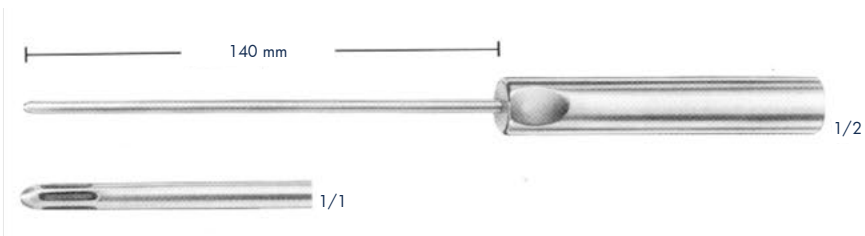

BIEMER

- OSI160307** Ø 4 mm
- OSI160308** Ø 6 mm

Curettes for aspiration lipectomy, with three apertures, slightly curved, malleable

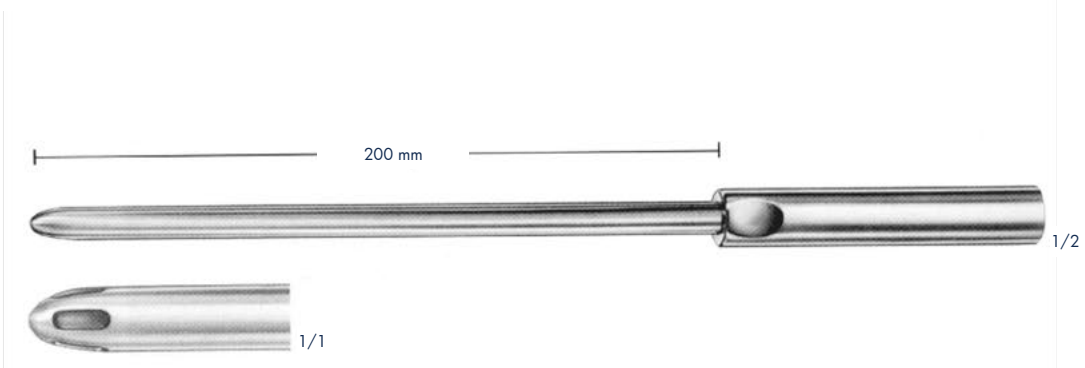

BIEMER

- OSI160309** Ø 8 mm
- OSI160310** Ø 10 mm
- OSI160311** Ø 12 mm

Curettes for aspiration lipectomy, with three apertures, slightly curved, malleable

Vacuum Currettes



- OSI160312** Ø 4 mm
- OSI160313** Ø 6 mm
- OSI160314** Ø 8 mm
- OSI160315** Ø 10 mm
- OSI160316** Ø 12 mm
- OSI160317** Ø 14 mm

Currettes, with graduation and suction interrupter, for vacuum curettage



OSI160318
Hose connection (inside diam. 11 mm), straight



OSI160319
Hose connection (inside diam. 11 mm), curved

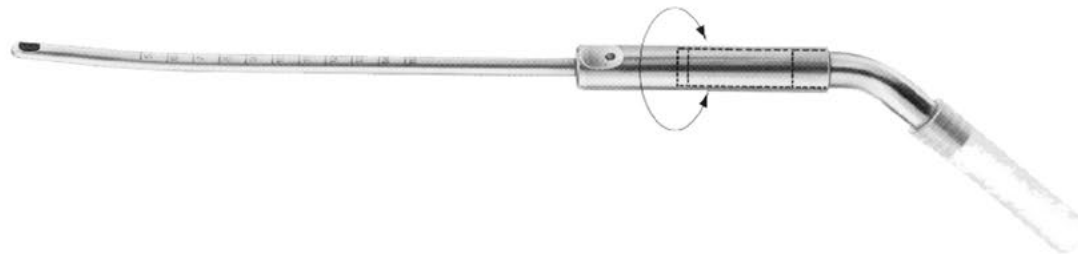

The new connection between suction curette and hose connection OSI160318 or OSI160319 guarantees quick changing and free turning of the suction currettes on the hose connection.

OSI160320
Transparent suction hose, 1.8 mm long, inside diam. 11 mm, outside diam. 16.5 mm, can be sterilized in an autoclave at 143 °C (3 bar)



OSI160321
Strainer for tissue, plastic, for single use only, to be used for histopathological examination

Suction Instruments

OSI160322

170 mm

For aspirating fluid from the excretory ducts of large glands and for keeping the operating area clear



OSI1690323

150 mm

For puncturing
Trocar



OSI160324

190 mm

For clearing large quantities of fluid



OSI160325

170 mm

For puncturing
Trocar



OSI160326

150 mm

Hollow needle, sharp



OSI160327

230 mm

For general surgery
double curved



OSI160328

190 mm

For tonsillectomy, oral
and laryngeal operations



OSI160329

220 mm

For tonsillectomy, oral
and laryngeal operations

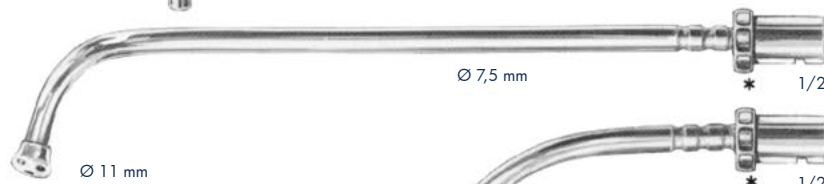

OSI160330

180 mm

For tonsillectomy, oral
and laryngeal operations



*With bayonet fitting to be used with suction handles
OSI160331 - OSI160332

Suction Instruments

OSI160331

Suction handle, with vacuum regulator and finger cut-off, brass, mirror-finish chromium-plated
150 mm



OSI160332

Suction handle, with vacuum regulator valve and quick-shutter, brass, mirror-finish chromium-plated
170 mm



With the suction handle the vacuum can be regulated in very fine dosages. The quick-shutter enables spontaneous interruption or immediate release of vacuum. At interruption the vacuum remains right up to the suction handle and it is not necessary to wait until the vacuum in the suction jar is formed again.

* Both suction handles have bayonet fitting and can be used for the suction cannulae.

Suction Instruments

OSI160333

Universal cannula, double curved
230 mm



OSI160334

S-shaped blunt cannula for aspirating fluid from the excretory ducts of large glands and keeping the operating area clear
170 mm



POOL

OSI160207

Suction cannula, with outer tube to be screwed of
225 mm

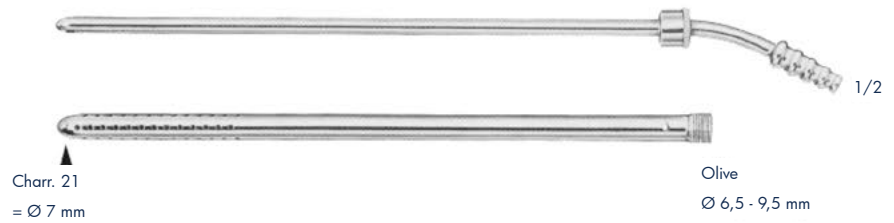

POOL

OSI160206

Suction cannula, with outer tube to be screwed of
225 mm

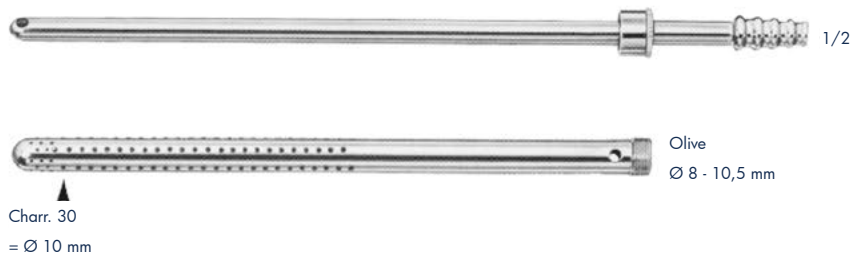

YANKUER

OSI160335

with central bore, 2.0 mm diam.
285 mm



Suction Instruments

DE BAKEY

OSI160336

with central bore,
3.0 mm diam. with lateral slots
275 mm

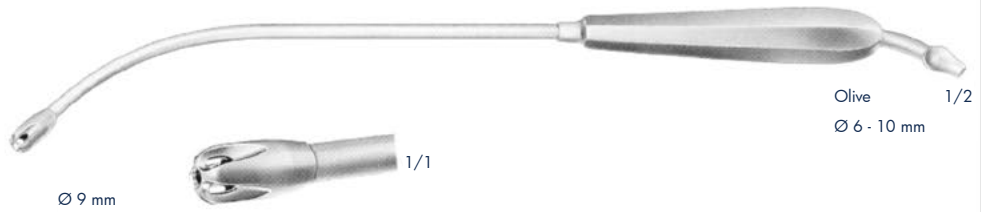

Olive 1/2
Ø 6 - 10 mm

YANKAUER

OSI160205

with especially large central bore,
4.8 mm diam.
285 mm



Olive 1/2
Ø 7 - 9 mm

DE BAKEY

OSI160337

with finger cut-off
and stylet
270 mm



Olive 1/2
Ø 9 mm

DE BAKEY

OSI160338

with finger cut-off
and stylet
160 mm

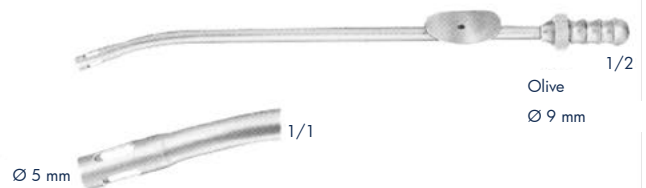

Olive 1/2
Ø 9 mm

OSI160339

with finger cut-off
190 mm



Olive 1/2
Ø 9 mm

Suction Instruments

ADSON

OSI160340

with finger cut-off and stylet
165 mm



PLESTER

OSI160341 Ø 1,5 mm

OSI160342 Ø 2,0 mm

OSI160343 Ø 2,5 mm

OSI160344 Ø 3,0 mm

with finger cut-off and stylet,
thumb piece parallel to curve, with LUER hub
195 mm



FERGUSSON

OSI160211 Ø 2,0 mm

OSI160212 Ø 2,5 mm

OSI160213 Ø 3,0 mm

OSI160214 Ø 4,0 mm

OSI160215 Ø 5,0 mm

with finger cut-off and stylet,
thumb piece 90° to curve, with LUER hub
180 mm



FERGUSSON

OSI160216 Ø 4,0 mm

insulated, with finger cut-off and stylet,
thumb piece 90° to curve, with LUER hub
180 mm



FRAZIER

OSI160217 Ø 3,0 mm

OSI160218 Ø 5,0 mm

with finger cut-off and stylet,
thumb piece 90° to curve, with LUER hub
180 mm



Suction Instruments

CONE

OSI160345

Handle, only, with finger cut-off

OSI160346 Ø 4 mm

OSI160347 Ø 5 mm

Cannula, only

180 mm



Olive
Ø 11 mm

LEMPERT

OSI160348 2 mm

OSI160349 3 mm

with finger cut-off and stylet

200 mm



Olive
Ø 7 - 9 mm

FORMBY

OSI160350 Ø 3,3 mm

210 mm

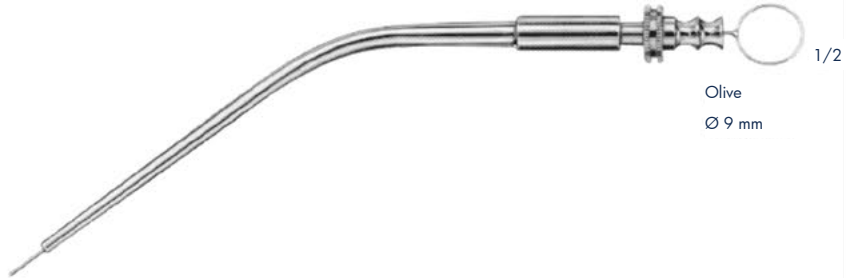

Olive
Ø 9 mm

BARRON

OSI160351 Ø 1,3 mm

OSI160352 Ø 2 mm

with finger cut-off and stylet

160 mm



Olive
Ø 8 mm

SCHUNKNECHT

OSI160353 Ø 20 swg, Ø 1 mm

OSI160354 Ø 24 swg, Ø 0,5 mm

130 mm



Olive
Ø 8 mm

Suction Instruments

WULLSTEIN

OSI160355

Mikro suction tube, complete, consisting of:

- OSI160356** Suction tube with LUER hub
- OSI160357** Micro suction cannula, 0.4 mm diam.
- OSI160358** Micro suction cannula, 0.6 mm diam.
- OSI160359** Micro suction cannula, 0.8 mm diam.



OSI160360

Suction set, complete, consisting of:

- OSI160361** Suction handle, with finger cut-off, with LUER cone
- OSI160362** 2 Suction cannulae, 0.5 mm diam., with LUER cone
- OSI160363** 2 Suction cannulae, 0.7 mm diam., with LUER cone
- OSI160364** 2 Suction cannulae, 1.0 mm diam., with LUER cone
- OSI160365** 2 Suction cannulae, 1.3 mm diam., with LUER cone

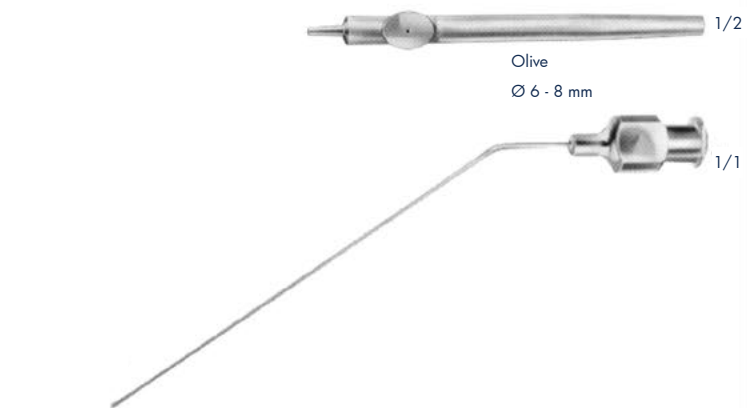

BELLUCCI

OSI160366

Suction set, complete, consisting of:

- OSI160367** Suction tube with finger cut-off and stylet, 155 mm
- OSI160368** Detachable end, 20 swg, Ø 1 mm
- OSI160369** Detachable end, 22 swg, Ø 0,7 mm
- OSI160370** Detachable end, 24 swg, Ø 0,5 mm

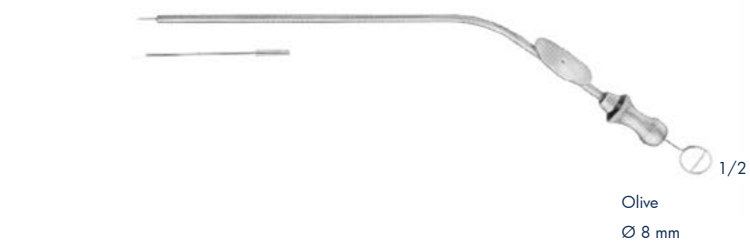

ZOELLNER

OSI160371

Suction cannula only, with stylet, fitting to the detachable ends **OSI160372** and **OSI160373**

180 mm

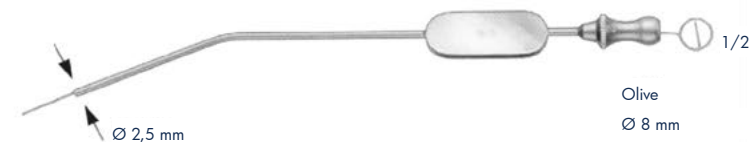

Suction Instruments

ZOELLNER

Detachable ends, fitting **OSI160371** and **OSI160367**

OSI160372 Ø 18 swg, Ø 1,2 mm

OSI160368 Ø 20 swg, Ø 1 mm

OSI160369 Ø 22 swg, Ø 0,7 mm

OSI160370 Ø 24 swg, Ø 0,5 mm

OSI160373 Ø 26 swg, Ø 0,4 mm

Sales unit: PZ = Package of 10 pieces

OSI160374

Suction tube, complete, consisting of:

OSI160375 Suction tub with light carrier

OSI160376 Suction tip 1.0 mm

OSI160377 Suction tip 1.5 mm

OSI160378 Suction tip 2.0 mm

OSI160379 Suction tip 2.5 mm

OSI160380 180 cm lang/long

OSI160381 250 cm lang/long

Light-guide, diam. 4.8 mm

steam-sterilizable up to 143° (3 bar)



VERHOEVEN

OSI160382 Ø 16 swg, Ø 1,5 mm

OSI160383 Ø 18 swg, Ø 1,2 mm

OSI160384 Ø 20 swg, Ø 1 mm

OSI160385 Ø 22 swg, Ø 0,7 mm

OSI160386 Ø 24 swg, Ø 0,5 mm

100 mm



HOUSE

OSI160387

Suction adapter with finger cut-off

55 mm

Luer



Olive
Ø 7 mm

WULLSTEIN

OSI160388

Suction tube, conical, silver, olive with LUER hub

160 mm

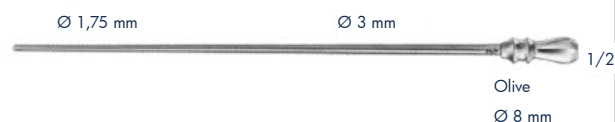

Olive
Ø 8 mm

Suction Instruments

WULLSTEIN

OSI160389 Ø 1,5 mm

OSI160390 Ø 2,0 mm

Suction tube, cylindrical, silver, with stylet, olive with LUER hub
160 mm



OSI160391 Ø 1,5 mm

OSI160392 Ø 2,0 mm

OSI160393 Ø 3,0 mm

Self clearing
230 mm



MAGILL

OSI160394 Ø 3,0 mm

OSI160395 Ø 3,5 mm

OSI160396 Ø 4,0 mm

245 mm



OSI160397

Stilette for MAGILL suction tubes

OSI160398

5.0 mm diam., tip 6.5 mm wide,
Nasal suction tube, with LUER hub
180 mm



OSI160399 Ø 4,5 mm

OSI160400 Ø 5,5 mm

Nasal suction tubes

175 mm



Suction Instruments

KILNER

OSI160401 Ø 4 mm
Nasal suction tube
190 mm



GILLIES

OSI160402 Ø 3 mm
with finger cut-off and stylet
170 mm



Olive
Ø 6 - 9 mm

OSI160403

Suction cannula for tonsillectomy,
oral- and laryngeal operations
220 mm



Olive
Ø 9 mm

OSI160404

Suction cannula for tonsillectomy,
oral- and laryngeal operations
180 mm



Olive
Ø 9 mm

ROWBOTHAM

OSI160405
with stylet
295 mm



Suction Instruments

usable length

YASARGIL

	usable length	diam.
OSI160406	130 mm	1,5 mm
OSI160201	150 mm	1,5 mm
OSI160407	180 mm	1,5 mm
OSI160408	220 mm	1,5 mm

OSI160409	130 mm	2,0 mm
OSI160410	150 mm	2,0 mm
OSI160202	180 mm	2,0 mm
OSI160411	220 mm	2,0 mm

YASARGIL

	usable length	diam.
OSI160412	130 mm	2,5 mm
OSI160203	150 mm	2,5 mm
OSI160413	180 mm	2,5 mm
OSI160414	220 mm	2,5 mm

OSI160415	130 mm	3,5 mm
OSI160204	150 mm	3,5 mm
OSI160416	180 mm	3,5 mm
OSI160417	220 mm	3,5 mm

OSI160459	180 mm	4,5 mm
------------------	--------	--------

Olive
 Ø 6,5 - 9 mm
 with LUER hub

Ø 3,5 mm

Ø 2,0 mm

OSI160418 500 mm
OSI160419 350 mm
 with rubber tip, with LUER hub

Olive
 Ø 9 mm

OSI160420 2,0 mm Ø/diam.
OSI160421 2,5 mm Ø/diam.
OSI160422 3,0 mm Ø/diam.
 with finger cut-off,
 thumb piece 90° to curve,
 with LUER hub
 250 mm

Olive
 Ø 6 - 9 mm 1/2

Suction Instruments

NEGUS

OSI160423

Suction dissector
210 mm



GORNEY

OSI160424

Suction dissector
180 mm



WEIR

OSI160425

Suction dissector, semi sharp
190 mm



OSI160426 4 mm wide

OSI160427 5 mm wide

Suction raspatories, sharp,
bayonet-shaped, with stylet
200 mm



LANDOLT

OSI160428 3,2 mm wide

Dissecting suction tube for hypo-
physectomie and ENT, sharp angled point
200 mm



LOPEZ-REINKE

OSI160429

Tonsil dissector with
suction device
235 mm



Combined Suction- and Irrigation Cannulae

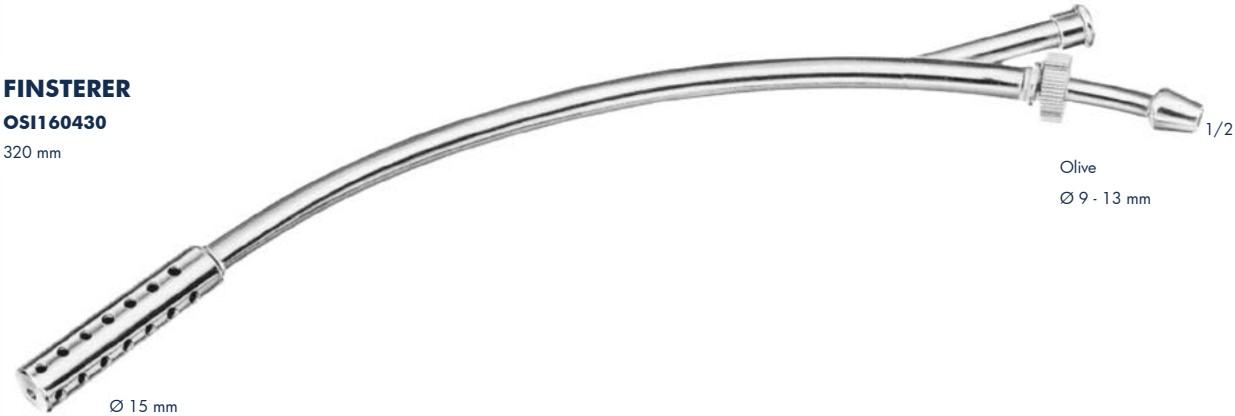

FINSTERER
OSI160430
320 mm

Olive
Ø 9 - 13 mm

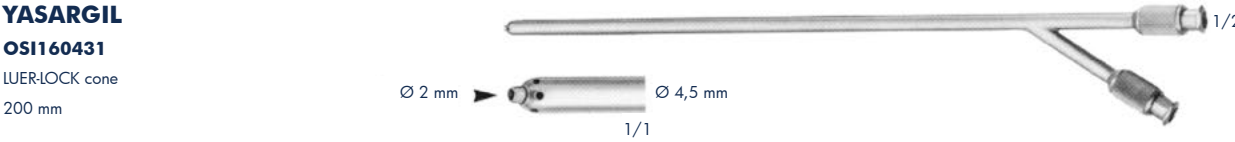

YASARGIL
OSI160431
LUER-LOCK cone
200 mm

Ø 2 mm Ø 4,5 mm
1/1

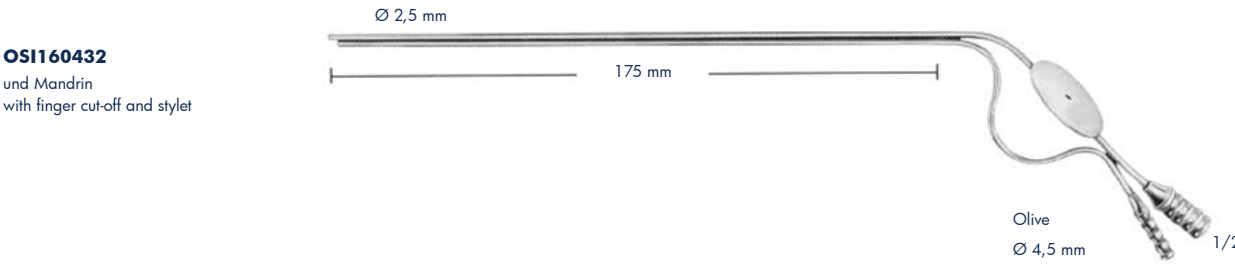

OSI160432
und Mandrin
with finger cut-off and stylet

Ø 2,5 mm
175 mm

Olive
Ø 4,5 mm
1/2

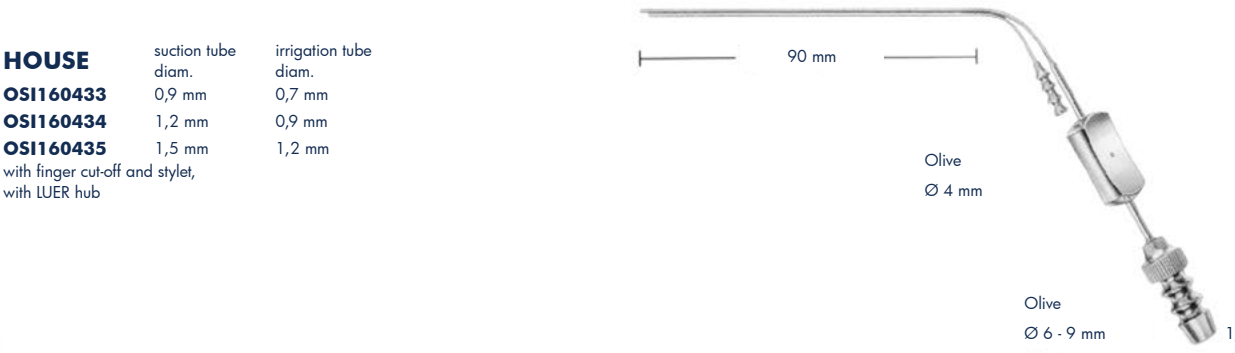

Coagulation Suction Cannulae

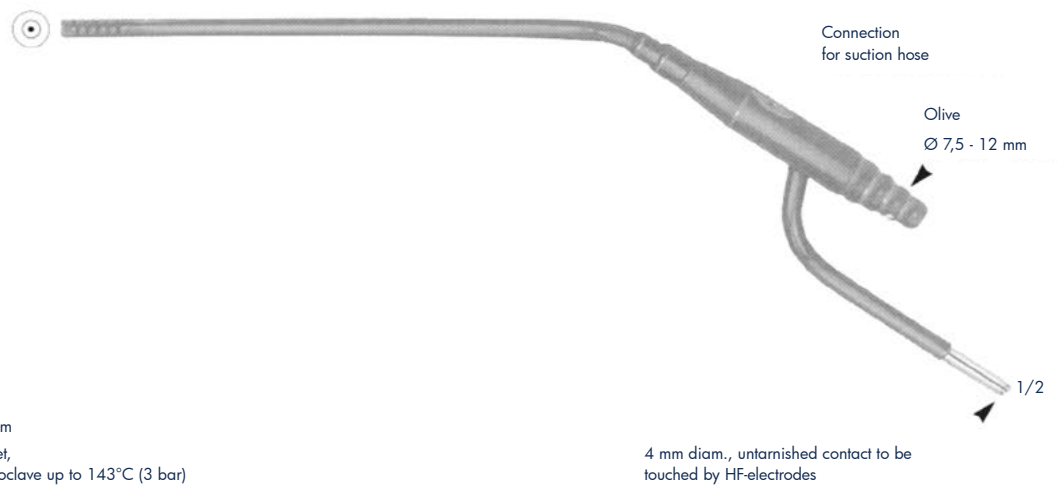
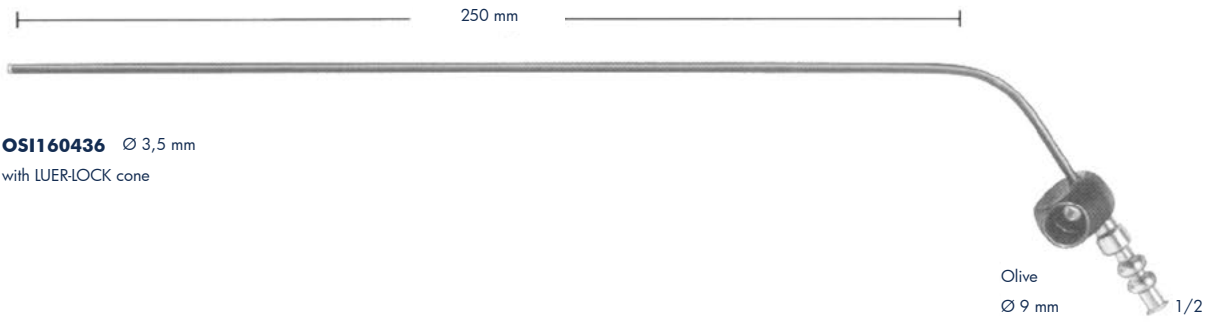

Medical Measures, Round Bowls, Kidney Tray



OSI280125
Medical measure, graduated,
0.25 litre



	Liter/litre	Dimensions in cm		
		upper	lower	height
OSI280120	0,4	11,1	7,2	5,6
OSI280121	1,0	15,1	10,0	7,3
OSI280122	2,5	21,1	14,5	9,6

Round bowls



OSI280123 250 mm
OSI280124 275 mm
Kidney tray

Sterilizing Forceps



CHEATTLE
OSI140188
1/3 280 mm



OSI140192
300 mm

OSI140189 200 mm straight
OSI140190 300 mm straight
OSI140192 300 mm curved



OSI140193
200 mm



ROGGE
OSI140194
235 mm

Anatomy - Post mortem

Cartilage knives



OSI100245 1/1



OSI100246 1/1



OSI100245 - OSI 100247
Dissecting scalpels,
metal handel
160 mm



OSI100247 1/1



OSI100279
55 mm
Length of blade
with rapsatory,
wooden handle



OSI100280
55 mm
Length of blade
Metal handle

Anatomy - Post mortem

Cartilage knives



OSI100277



LANGENBECK
OSI100277 - OSI100278

55 mm
Length of blade
Metal handle



OSI100278



OSI100276
65 mm
Length of blade
Metal handle



OSI100281
70 mm
Length of blade
Wooden handle

Autopsy knives

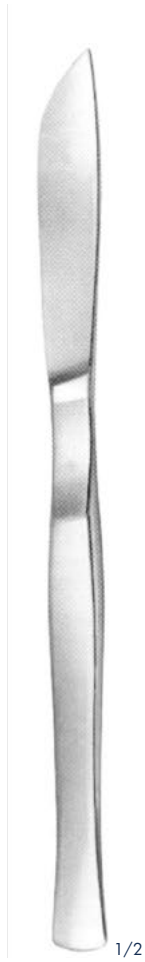

VIRCHOW
OSI100282
85 mm
Length of blade
Metal handle



VIRCHOW
OSI100283
95 mm
Length of blade
Wooden handle



OSI100284
115 mm
Length of blade
Wooden handle

Anatomy - Post mortem

Autopsy knives



OSI100285
80 mm
Length of blade
Metal handle



OSI100286
130 mm
Length of blade
Metal handle



OSI100287
195 mm
Length of blade
Metal handle

Anatomy - Post mortem

Throat knife



1/2

OSI100288
100 mm
Length of blade
Metal handle

Autopsy knives



1/2

OSI100289
110 mm
Length of blade
Wooden handle



1/2

OSI100111
170 mm
Length of blade
Wooden handle

Anatomy - Post mortem

Brain knives



VIRCHOW
OSI100290
160 mm
Length of blade
Metal handle



VIRCHOW
OSI100291
100 mm
Length of blade
Metal handle



VIRCHOW
OSI100292
240 mm
Length of blade
Metal handle

Blood scoops



OSI150718
50 ccm
3 cu. inches



OSI150719
150 cc
9 cu. inches

Anatomy - Post mortem

Dissecting- and tissue forceps



OSI120111 130 mm
OSI120112 145 mm
OSI120113 160 mm
 medium



STANDARD
OSI120104 145 mm
OSI120105 160 mm
OSI120106 180 mm
OSI120107 200 mm
OSI120108 250 mm



OSI120379 130 mm
OSI120380 145 mm
OSI120382 160 mm
 medium



STANDARD
OSI120171 145 mm
OSI120172 160 mm
OSI120173 180 mm
OSI120174 200 mm
OSI120175 250 mm

Muscle scissors

Surgical scissors



OSI110111 130 mm
OSI110112 145 mm
OSI110113 150 mm
OSI110114 165 mm



OSI110136 130 mm
OSI110137 145 mm
OSI110138 150 mm
OSI110139 165 mm



MAYO-NOBLE
OSI110173
 170 mm

Anatomy - Post mortem

Dissecting scissors



OSI110298
120 mm



OSI110589
145 mm

Incision scissors



OSI110148 130 mm
OSI110149 145 mm
OSI110551 165 mm

Bone shears



OSI190614
225 mm
1/2

Bowel scissors



OSI110814
210 mm



OSI110815
210 mm

Rip shears



OSI190615
230 mm



GLUCK
OSI200524
190 mm

Anatomy - Post mortem



OSI100874
Skull breaker
140 mm



OSI190875
Spine wrench
220 mm



OSI190876
Osteotome
130 mm

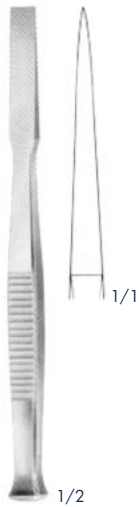

OSI190107 8 mm
OSI190108 10 mm
OSI190109 12 mm
Osteotome
140 mm

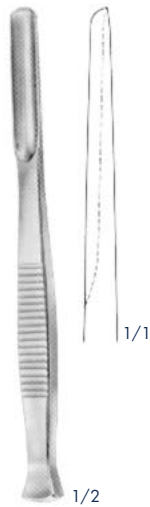

OSI190117 8 mm
OSI190118 10 mm
OSI190119 12 mm
Gouges
140 mm



STILLE
OSI180257 8 mm
OSI190162 10 mm
OSI180258 12 mm
OSI190163 15 mm
OSI190164 20 mm
OSI190165 25 mm
Osteotome
205 mm



OSI180302
Chisel
245 mm



BRUNETTI BRUNETTI
OSI180591 **OSI180592**
Chisels, for opening the spinal column
285 mm

Anatomy - Post mortem

Mallets

HARTPRESS

can be sterilized in a steam sterilizer up to 143° C (3 bar)

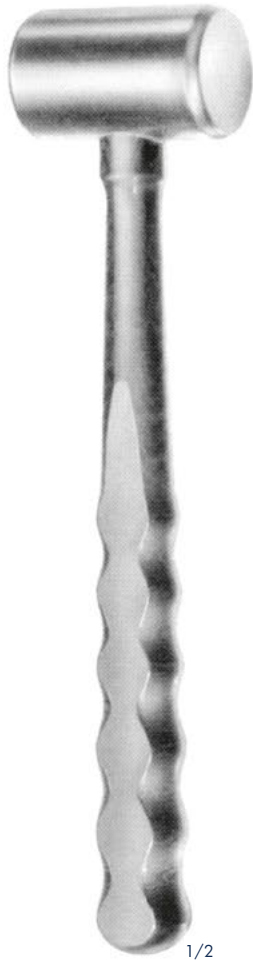

OSI180200 Ø 35 mm
OSI180201 Ø 42 mm
OSI180202 Ø 50 mm
250 mm



OMBREDANNE

OSI180210 520 g
240 mm



BERGMANN

OSI180208 245 g
235 mm

Anatomy - Post mortem

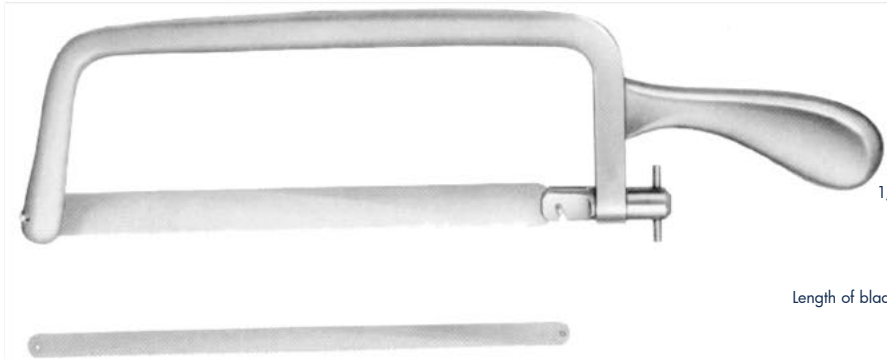

CHARRIERE

OSI180116

Bow saw,
complete with one saw blade
each **OSI180114** 12 mm and
OSI180115 18 mm
350 mm

Length of blade } 215 mm

Spare saw blades, carbon steel

OSI180114 12 mm

OSI180115 18 mm

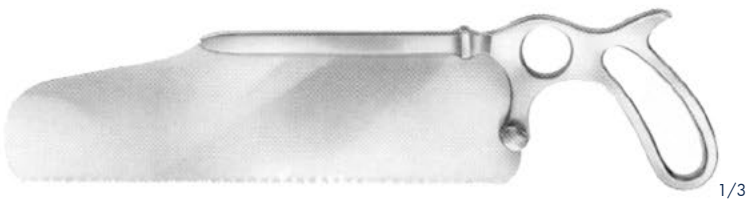

SATTERLEE

OSI180120

290 mm

Length of blade } 215 mm

Spare saw blade

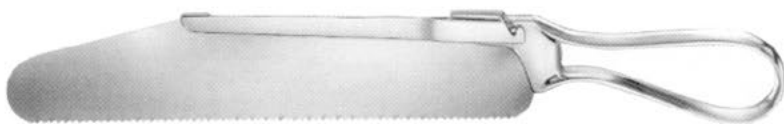

CHARRIERE

OSI210518

270 mm

CHARRIERE

OSI210520

340 mm

Length of blade } 184 mm

Spare saw blades

OSI210519

253 mm

carbon steel

OSI210521

Anatomy - Post mortem



LANGENBECK
OSI180593
215 mm



FERGUSSON
OSI190500
205 mm



SEMB
OSI190507
190 mm



OSI180594
Skull holder, prongs are turnable to fit Exactly the shape of the skull

Retractors, double



OSI180595
65 mm

Otology

POLITZER

OSI250834 Set of 3 sizes

OSI250835 Ø 2 mm

OSI250836 Ø 3 mm

OSI250837 Ø 4 mm

Aural speculae for children, inside non-reflective, outside mirror finish chromium plated



Ø 2 mm

Ø 3 mm

Ø 4 mm



OSI250835

OSI250836

OSI250837

HARTMANN

OSI250838 Ø 1,8 mm

OSI250839 Ø 3,2 mm

OSI250840 Ø 4,6 mm

Ear specula for children, inside non-reflective, outside mirror finish chromium plated

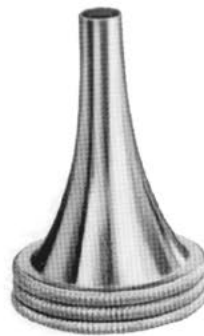

Ø 1,8 mm

Ø 3,2 mm

Ø 4,6 mm



OSI250838

OSI250839

OSI250840

HARTMANN

OSI250841 Set of 3 sizes

OSI250842 Ø 3,5 mm

OSI250843 Ø 5,0 mm

OSI250844 Ø 6,5 mm

OSI250845 Ø 8,0 mm

Ear speculae for adults, inside non-reflective, outside mirror finish chromium plated



Ø 3,5 mm

Ø 5,0 mm

Ø 6,5 mm

Ø 8,0 mm



OSI250842

OSI250843

OSI250844

OSI250845

BOUCHERON

OSI250846 Set of 4 sizes

OSI250847 Ø 4,2 mm

OSI250848 Ø 5,2 mm

OSI250849 Ø 6,2 mm

OSI250850 Ø 7,2 mm

Ear speculae for adults, inside non-reflective, outside mirror finish chromium plated



Ø 4,2 mm

Ø 5,2 mm

Ø 6,2 mm

Ø 7,2 mm



OSI250847

OSI250848

OSI250849

OSI250850

All measurements refer to the inner diameter

Otology

GRUBER

- OSI250851** Ø 3 x 3,9 mm
- OSI250852** Ø 4 x 4,6 mm
- OSI250853** Ø 6 x 5,2 mm
- OSI250854** Ø 7 x 5,3 mm

Aural specula, oval lumen



3 x 3,9 mm 4 x 4,6 mm 6 x 5,2 mm 7 x 6,3 mm



OSI250851 **OSI250852** **OSI250853** **OSI250854**

GRUBER

OSI250855

Aural specula, oval lumen, Set of 4 sizes



4 x 2,7 mm 5 x 4,3 mm 7 x 5,4 mm 8 x 6,4 mm



TOYNBEE

- OSI250856** Set of 3 sizes
 - OSI250857** Ø 4,0 mm
 - OSI250858** Ø 5,5 mm
 - OSI250859** Ø 7,0 mm
- Ear Specula for adults, inside non-reflective, outside mirror finish chromium plated

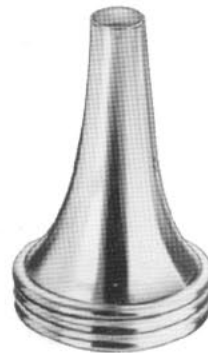

Ø 4 mm Ø 5,5 mm Ø 7 mm



OSI250857 **OSI250858** **OSI250859**

HARTMANN

- OSI250860** Ø 8 mm
- OSI250861** Ø 9 mm

Ear specula for post-treatment, for adults, aluminium, black anodized

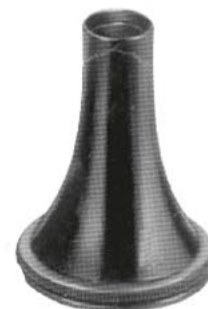

Ø 8 mm Ø 9 mm



OSI250860 **OSI250861**

All measurements refer to the inner diameter

Otology

HARTMANN

OSI250862 Ø 3 mm

OSI250863 Ø 4 mm

OSI250864 Ø 5 mm

OSI250865 Ø 7 mm

Ear specula for adults, aluminium, black, anodized



Ø 3 mm Ø 4 mm Ø 5 mm Ø 7 mm



OSI250862 **OSI250863** **OSI250864** **OSI250865**

TUMARKIN

OSI250866 Set of 8 sizes

OSI250867 Ø 3,2 mm

OSI250868 Ø 5,0 mm

OSI250869 Ø 5,5 mm

OSI250870 Ø 6,2 mm

OSI250871 Ø 6,6 mm

OSI250872 Ø 7,0 mm

OSI250873 Ø 7,2 mm

OSI250874 Ø 9,2 mm

Ear specula tapered slot



Ø 3,2 mm Ø 5,0 mm Ø 5,5 mm Ø 6,2 mm



OSI250867 **OSI250868** **OSI250869** **OSI250870**

Ø 6,6 mm Ø 7,0 mm Ø 7,2 mm Ø 9,2 mm



OSI250871 **OSI250872** **OSI250873** **OSI250874**

ROSEN

OSI250875 Ø 3 mm

OSI250876 Ø 4 mm

OSI250877 Ø 5 mm

OSI250878 Ø 6 mm

OSI250879 Ø 7 mm

Aural specula, round lumen



Ø 3 mm Ø 4 mm Ø 5 mm



OSI250875 **OSI250876** **OSI250877**

Ø 6 mm Ø 7 mm



OSI250878 **OSI250879**

ROSEN

OSI250880 Ø 3,0 x 4,0 mm

OSI250881 Ø 4,0 x 5,5 mm

OSI250882 Ø 5,0 x 7,5 mm

OSI250883 Ø 6,0 x 8,5 mm

OSI250884 Ø 7,0 x 9,5 mm

Aural specula, oval lumen



Ø 3,0 x 4,0 mm Ø 4,0 x 5,5 mm Ø 5,0 x 7,5 mm



OSI250880 **OSI250881** **OSI250882**

Ø 6,0 x 8,5 mm Ø 7,0 x 9,5 mm



OSI250883 **OSI250884**

All measurements refer to the inner diameter

Otology

SHEA

- OSI250885** Set of 5 sizes
- OSI250886** 3,3 x 4,0 mm
- OSI250887** 4,0 x 5,4 mm
- OSI250888** 5,0 x 7,3 mm
- OSI250889** 6,0 x 8,3 mm
- OSI250890** 7,3 x 9,7 mm

Ear specula, oblique ended



ZÖLLNER

- OSI250891** 5,5 x 6,5 mm
- OSI250892** 6,5 x 7,5 mm
- OSI250893** 7,5 x 8,5 mm
- OSI250894** 8,5 x 9,5 mm
- OSI250895** 9,5 x 10,5 mm
- OSI250896** 10,5 x 11,5 mm

Ear specula for adults, oval made of aluminium, in and outside black anodised to eliminate reflection



OSI250897

Rack for 12 ear specula, base plate made of plastic, Measurement : 111 x 83 x 37 mm

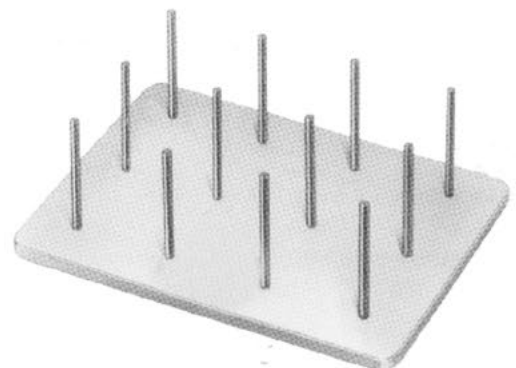

STIERLEN

OSI250898

Magnifying loupe, magnification 2 ½ times, adaptable for all ear specula in use, with shoulder cord



Magnifying loupe during magnification with aural forceps and ear speculum

LEYLA

OSI250899

Ear specula holder, flexible, for attaching to head bow or the railing of operating table. The flexible arm can be put in any fixed position by means of wing-screw attached to an eccentric



YASARGIL

OSI250900

Flexible arm only, mobile in all directions



OSI250901

Clamp for fixing flexible arm
to the operating table

to the bow or the railing of



OSI250902

Ear specula holder only, for specula:



HARTMANN

OSI250260 = c 128
OSI250261 = c1 256
OSI250262 = c2 512

OSI250263 = c3 1024
OSI250825 = c4 2048
OSI250826 = c5 4096

Tuning forks



OSI250827 = a1 440

Tuning forks



LUCAE

OSI250904 = c 128
OSI250905 = c1 256
OSI250906 = c2 512
OSI250907 = c3 1024
OSI250908 = c4 2048

Tuning forks



OSI250247 = c 128

OSI250248 = c1 256

Tuning forks



LUCAE

OSI250909 = c 128

Tuning fork (for neurologists)



RYDEL-SEIFFER

OSI250828 = c 64 or/order c 128

Tuning fork with clamp c 64,
without clamp c 128

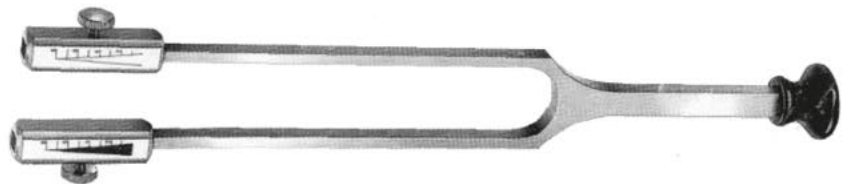

OSI250911 = c 128

Tuning for, aluminium-alloy

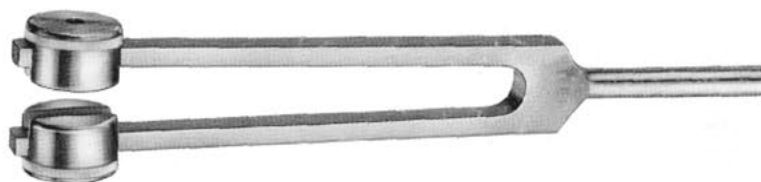

BARANY

OSI260778

Noise apparatus fitted with a cone

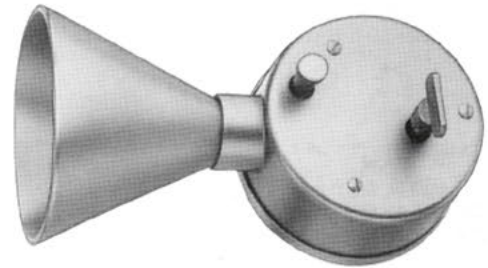

SYRINGE

OSI250912 85ml/3fl oz

OSI250913 114ml/4fl oz

Ear syringe, all metal, complete with conical and bulbous pipes

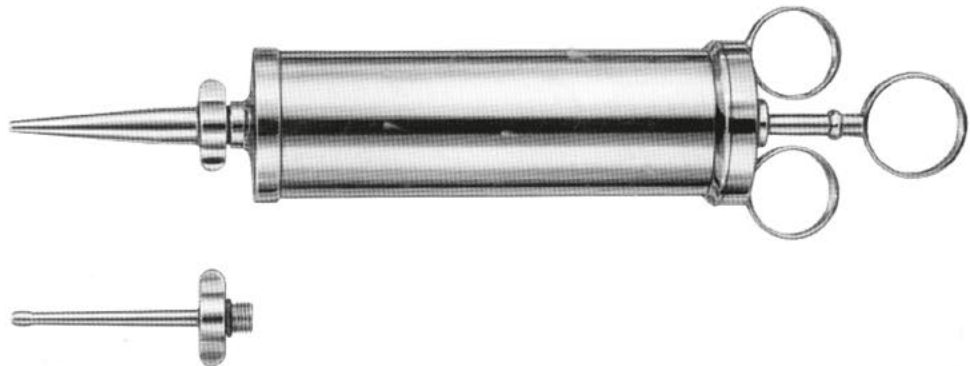

OSI250914

Conical metal pipe, for use with **OSI250912** and **OSI250913**



NOOTS

OSI250920

Aluminium ear trough seamless
203 mm

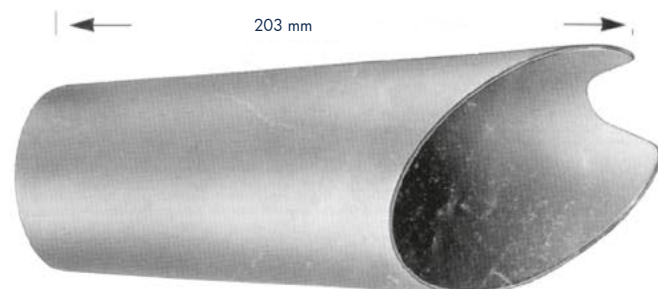

POLITZER

OSI250915

Air douche, with metal mount

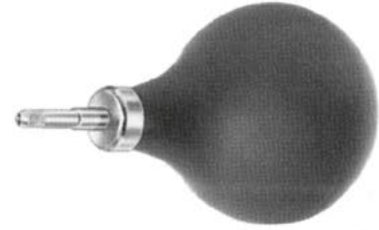

OSI250916 Ø 18 mm

OSI250917 Ø 21 mm

OSI250918 Ø 23 mm

Metal nasal tips



OSI250919

Metal connector (Eustachian catheter to Politzer air douche) to connect Eustachian catheter to Politzer bulb



HARTMANN

OSI250255 Ø 2,0 mm

OSI250256 Ø 2,5 mm

OSI250257 Ø 3,0 mm

OSI250258 Ø 4,0 mm

OSI250259 Ø 5,0 mm

Eustachian catheters

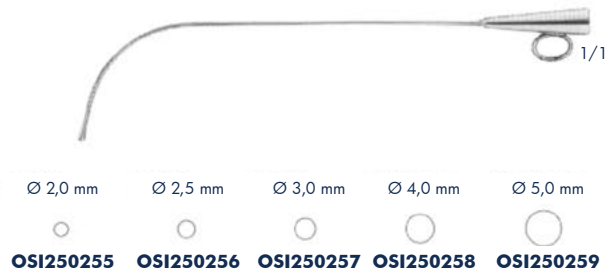

KABIERSKE

OSI260750

Powder blower, complete with 3 metal tips

OSI260751

Rubber bulb only

OSI260754

Larynx tip

OSI260752

Nasal tip

OSI260755

Metal mounting only

OSI260753

Aural tip

OSI260756

Spare glasses only

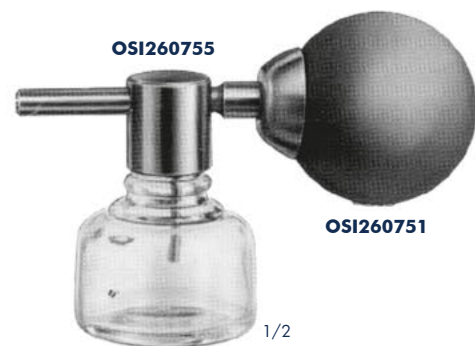

BUCK

OSI250922 Ø 0,9 mm

Applicator, rough spiral serrated end
120 mm



OSI250923 Ø 1,0 mm

OSI250924 Ø 1,2 mm

Applicator, spiral
serrated end
140 mm



FARRELL

OSI160246 Ø 1,2 mm

Applicator, round serrated end
110 mm



FARRELL

OSI160168 Ø 1,2 mm

Applicator, round serrated end
140 mm

LATHBURY-FARRELL

OSI160247 Ø 1,4 mm

Applicator, triangular serrated end
110 mm



LATHBURY-FARRELL

OSI160169 Ø 1,4 mm

Applicator, round serrated end dreikant gerieft
140 mm



OSI160173 Ø 0,9 mm

Applicator, triangular serrated end
140 mm

MODELL PICCOLO

OSI250933 Ø 0,7 mm

Applicator, slender, round serrated end
110 mm



MODELL PICCOLO

OSI250934 Ø 0,7 mm

Applicator, slender, round serrated end
110 mm



JOBSON HORNE

OSI250935

Ear probe
140 mm



OSI250936

Ear probe
180 mm



TUMARKIN

OSI250937

Ear probe
Sales unit: PA =Package of 50 pieces
152 mm

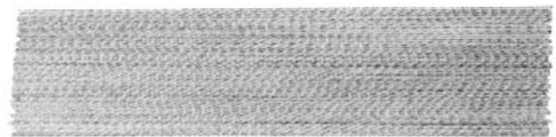

FORMBY

OSI250938

Cerumen scoop and hook
180 mm



CAWTHORNE

OSI250939

Silver probe, ring handled and
flattened end
140 mm



Otology

BILLEAU

OSI250344

OSI250345

Ear loop, straight

160 mm



SNELLEN

OSI250940

Ear loop, curved, serrated

160 mm



LANGENBECK

OSI250302

Ear loop, blunt, slightly curved

130 mm



ZAUFAL

OSI250347

Ear elevator, blunt

160 mm



MUSGROVE

OSI250941

Cerumen pick and wool carrier

180 mm



LUCAE

OSI250349
OSI250350
OSI250351

Ear hooks, probe ended
140 mm

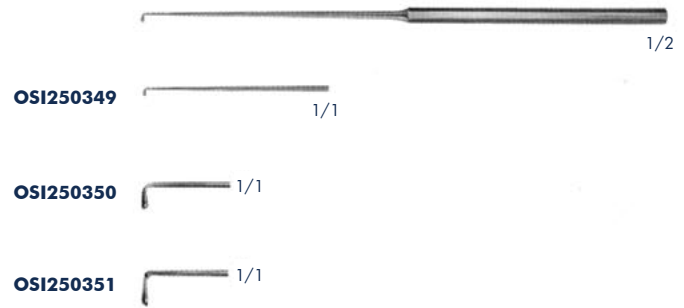

ZAUFAL-JANSEN

OSI250954

Ear hooks, probe ended
150 mm



WAGENER

OSI250353
OSI250354
OSI250355
OSI250356

Ear hooks, probe ended
150 mm

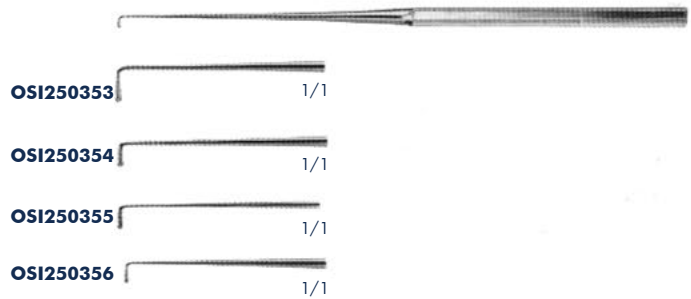

STACKE

OSI160126 Ø 0,8 mm

Ear probe, silver
100 mm



CAWTHORNE

OSI250955

Cerumen hook
143 mm

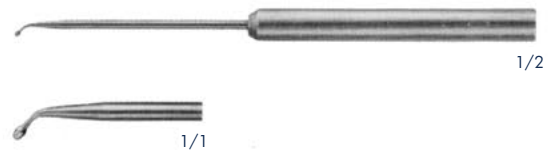

ST. BARTS

OSI250944

Blunt hook
180 mm

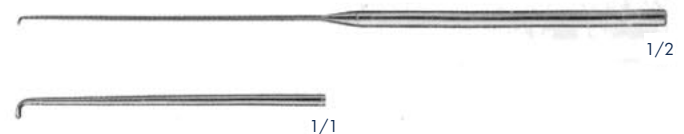

HARTMANN-WULLSTEIN

OSI250280 - OSI250946

Ear forceps for examination. Extra fine pattern, opening and closing of the jaws by means of finger ring-handle

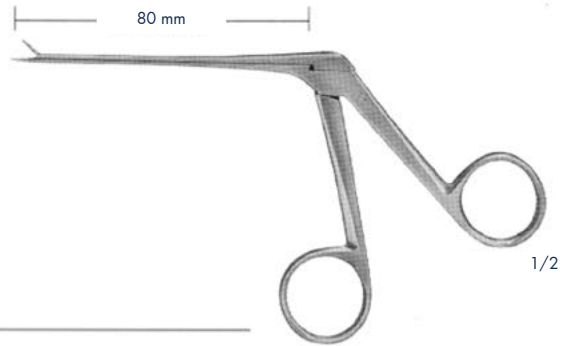

HARTMANN-WULLSTEIN

OSI250280 0.8 x 6 mm

Ear forceps, straight



OSI250945 1.8 x 8 mm

Ear forceps, serrated jaws, straight



HARTMANN-WULLSTEIN

OSI250281 1 mm

Ear forceps, cup-shaped, straight



OSI250946 2 mm

Ear forceps, cup-shaped



HENCKEL

OSI250947 2,5 mm x 5,0 mm

Ear forceps, flat oval spoon, fenestrated

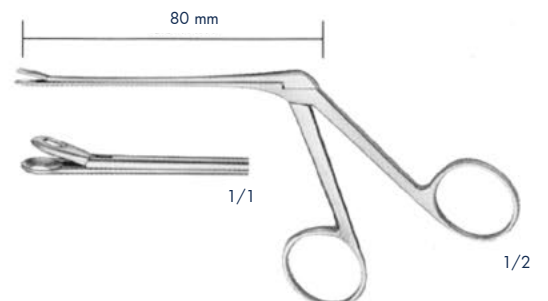

ORMEROD

OSI250948 4 mm

Aural forceps, round cup, straight

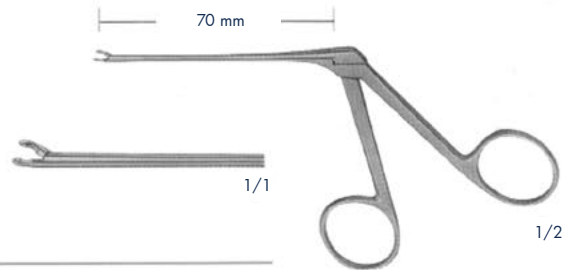

ORMEROD

OSI250949 5 mm x 1 mm

Aural forceps, straight



CAWTHORNE

OSI260265 1,25 mm x 7,0 mm

Aural forceps, smooth jaws, straight



HARTMANN

OSI250276

Ear tampon forceps, delicate pattern

135 mm



HARTMANN

OSI250277

Ear tampon forceps, strong pattern

135 mm



TILLEY

OSI250951

Ear tampon forceps, extra fine pattern

140 mm

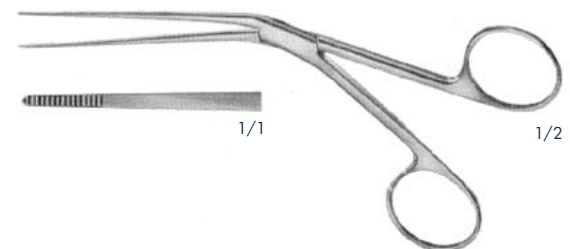

Otology

POLITZER

OSI250362

Sickle knife
160 mm



LUCAE

OSI250370

Tympanum perforator, bayonet-shaped, for children
160 mm

OSI250371

Tympanum perforator, bayonet-shaped, for adults
190 mm

OSI250952

Myringotome, bayonet shaped, for children,
handle 90° angled to the lancet
180 mm

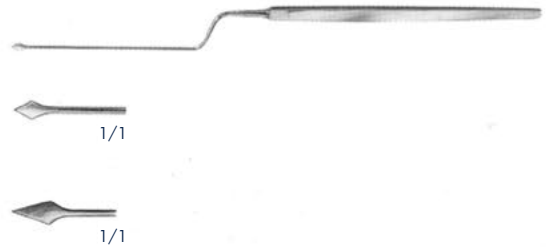

POLITZER

OSI250368

Tympanum perforator, angled myringotome
160 mm



AGNEW (POLITZER)

OSI250369

Myringotome angled
175 mm



OSI250953

Universal-Myringotome, adjustable blade, reversing into handle
170 mm

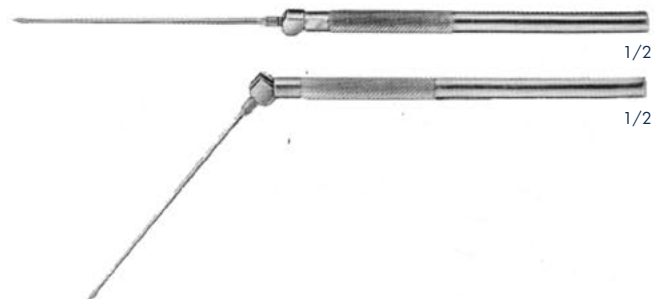

Otology

KRAUSE

OSI250264

Aural snare
165 mm

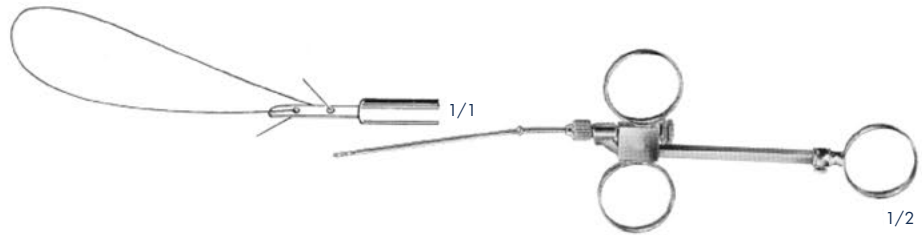

OSI250956 Ø 0,2 mm

Aural snare wire
Sales unit: PH=Package of 100 pieces



OSI110412

Wire cutting scissors, one blade serrated
120 mm

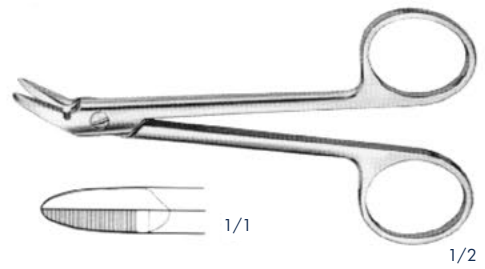

OSI110449

Wire cutting scissors, with tungsten carbide inserts
120 mm

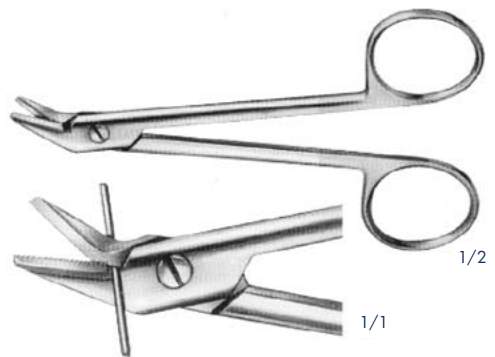

HARVEY

OSI110710

Wire cutting scissors
125 mm

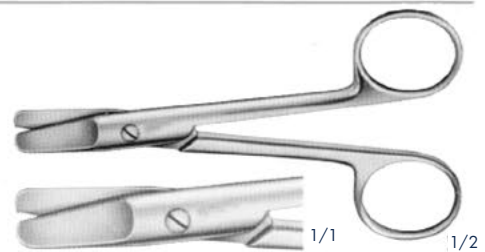

OSI180483

Wire cutting and bending pliers
160 mm



Otology

MUCK

OSI250957

Periosteal knife
150 mm

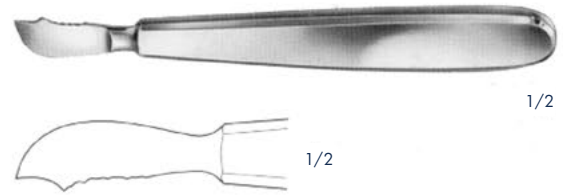

KÖNIG

OSI250958 4,5 mm

Elevator
150 mm

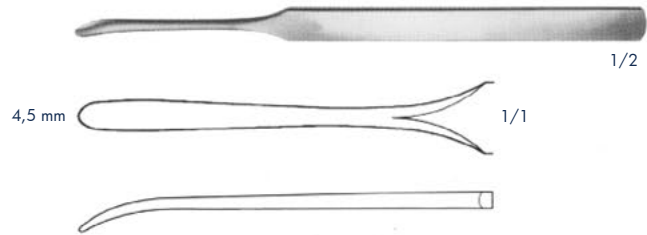

SEBILEAU

OSI250959 5 mm

Elevator
175 mm

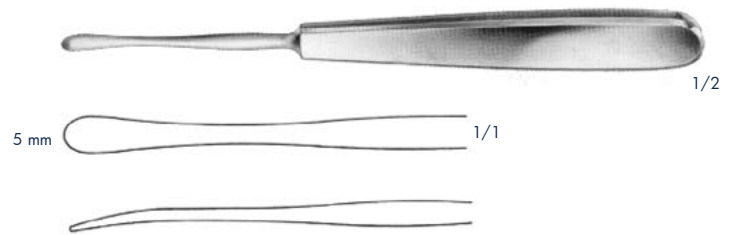

LANGENBECK-QUERVIAN

OSI250960 6 mm

Elevator
195 mm

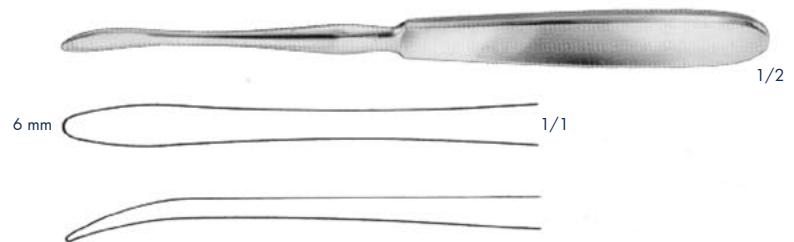

OSI190712 6 mm

Raspatory, straight, tip straight
190 mm

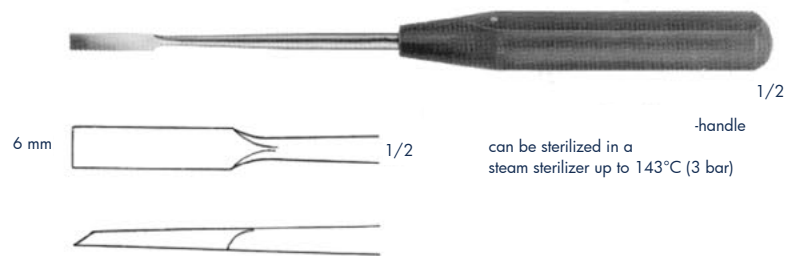

OSI190425 6 mm

Raspatory, straight, tip straight
190 mm

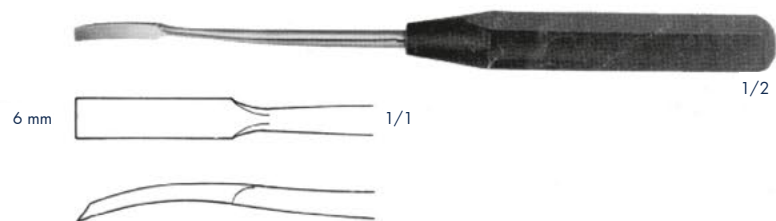

Otology

**LEMPERT
OSI250961**

Raspatory, semi sharp
185 mm



6,3 mm

**LEMPERT
OSI190671**

Evelator, blunt, narrow
165 mm



1/2



1/1

OSI190426 6 mm
Raspatory, curved, tip round
190 mm



1/2

6 mm 1/1



HARTPRESS -handle
can be sterilized in a
steam sterilizer up to 143°C (3 bar)

OSI250963 - OSI 190701
Raspatory, slightly curved
165 mm



1/2

OSI250963 1/1

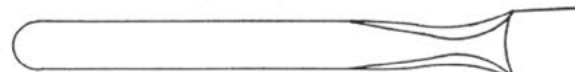

OSI190701 1/1



Otology

MARTINI

OSI250964

Ear curette, double ended
140 mm

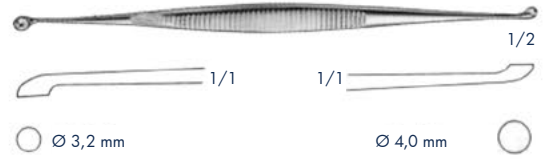

JANSEN

OSI250338

Ear curette, double ended
160 mm



JACOBSON

OSI250965

Ear curette, double ended
140 mm

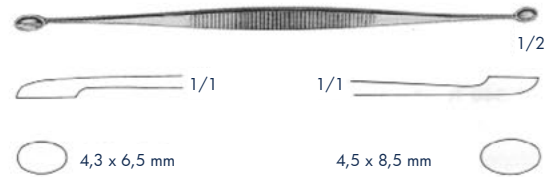

WILLIGER

OSI250966

Ear curette, double ended
145 mm

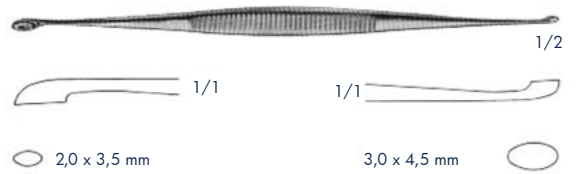

BARTH-PREYSING

OSI250339

Ear curette, double ended
180 mm



MILLER

OSI250967

Ear curette, double ended
180 mm



LAKE

OSI250968

Aural probe, double ended
185 mm



Otology

LEMPERT

- OSI250383
- OSI250382
- OSI250381
- OSI250380
- OSI250379

Endaural curettes
215 mm



1,8 mm 2,0 mm 2,4 mm 2,6 mm 2,8 mm



OSI250383 OSI250382 OSI250381 OSI250380 OSI250379

VOLKMANN

- OSI190316
- OSI190317
- OSI190318
- OSI190319
- OSI190320
- OSI190324
- OSI190325

Endaural curettes
170 mm

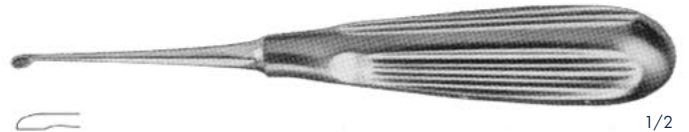

2,8 mm 3,6 mm 4,4 mm 5,2 mm 6,8 mm



OSI190316 OSI190317 OSI190318 OSI190319 OSI190320

13,0 mm

14,5 mm



OSI190324

OSI190325

WILLIGER

- OSI190349
- OSI190351

Endaural curettes
170 mm



3,4 mm 5,2 mm



OSI190349 OSI190351

Otology

OSI180216 Ø 3 mm
OSI180217 Ø 5 mm
 Haemostatic tamper
 160 mm



1/2

OSI180216 ○

OSI180217 ○

PASSOW

OSI180214 2,5 mm
OSI180215 3,5 mm
 Haemostatic chisel
 120 mm



1/2

OSI180214 □

OSI180215 □

THIES

OSI250969 2 mm
OSI250970 3 mm
OSI250971 4 mm
 Gouges
 160 mm



1/2



1/1

LUCAS

OSI180238 4 mm
OSI180239 6 mm
 Chisels
 160 mm



1/2

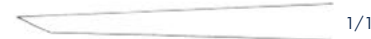

1/1

LUCAS

OSI180240 3 mm
OSI180241 5 mm
 Gouges
 160 mm



1/2

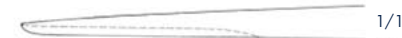

1/1

OSI180288 10 mm
OSI180289 15 mm
OSI180290 20 mm
 Osteotomes, straight
 200 mm



1/2



1/1

HARDPRESS handle
 can be sterilized in a
 steam sterilizer up to
 143°C (3 bar)

OSI180291 10 mm
OSI180292 15 mm
OSI180293 20 mm
 Osteotomes, curved
 200 mm



1/2



1/1

Otology

JANSEN

- OSI250972 4 mm
- OSI250973 6 mm
- OSI190107 8 mm
- OSI190108 10 mm
- OSI190109 12 mm

Osteotomes
140 mm

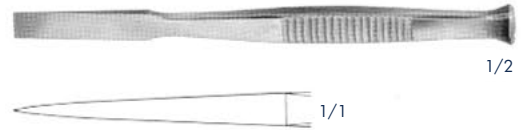

JANSEN

- OSI250974 4 mm
- OSI250975 6 mm
- OSI190112 8 mm
- OSI190113 10 mm
- OSI190114 12 mm

Chisels
140 mm

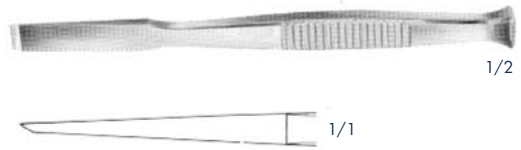

JANSEN

- OSI250976 4 mm
- OSI250977 6 mm
- OSI190117 8 mm
- OSI190118 10 mm
- OSI190119 12 mm

Gouges
140 mm

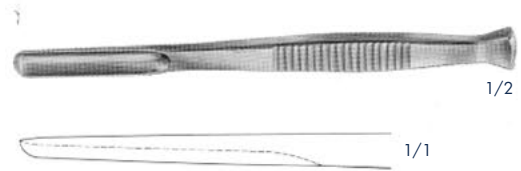

PARTSCH

- OSI190127 3 mm
- OSI190128 4 mm
- OSI190129 5 mm
- OSI190130 6 mm

Chisels
140 mm

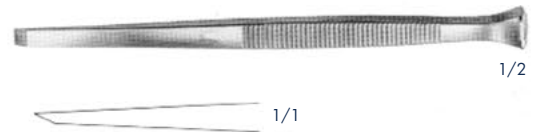

PARTSCH

- OSI190137 3 mm
- OSI190138 4 mm
- OSI190139 5 mm
- OSI190140 6 mm

Gouges
140 mm

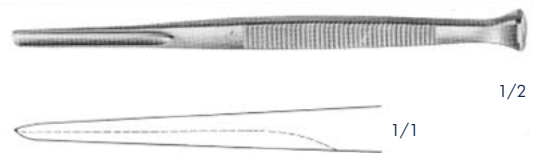

LEXER-MINI

- OSI190176 4 mm
- OSI190177 6 mm
- OSI190178 8 mm
- OSI190179 10 mm
- OSI190180 12 mm

Osteotome
180 mm

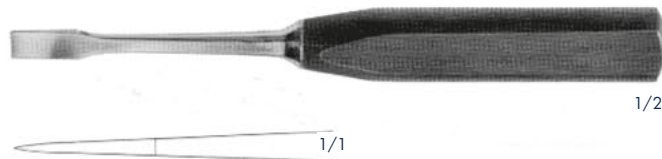

1/2

HARDPRESS -handle
can be sterilized in a
steam sterilizer up to
143°C (3 bar)

LEXER-MINI

- OSI190181 4 mm
- OSI190182 6 mm
- OSI190183 8 mm
- OSI190184 10 mm
- OSI190185 12 mm

Gouges
180 mm

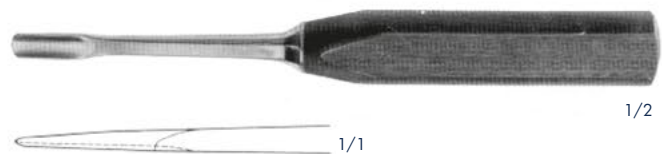

1/2

Otology

BEYER

OSI190565

ZAUFGAL-JANSEN

OSI190566

Rongeur, curved, double Action
180 mm

OSI190565

OSI190566

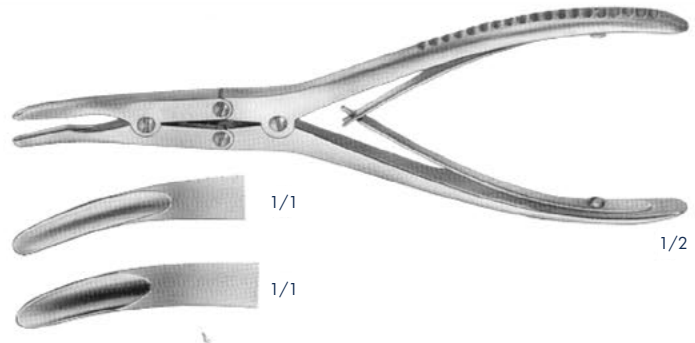

STAMM

OSI190846

Bone cutting forceps
150 mm

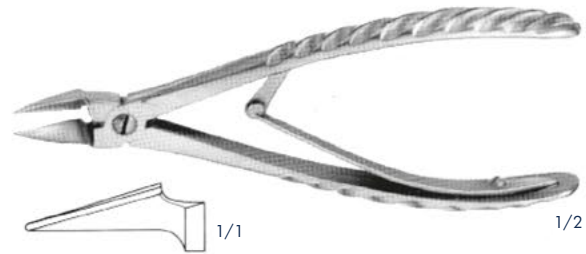

OSI190847

Bone cutting forceps, curved on flat
170 mm

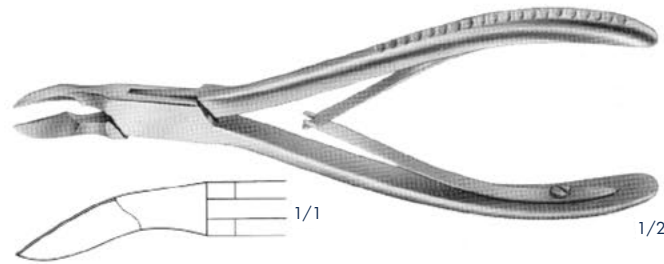

BÖHLER

OSI180172

Bone cutting forceps, curved on flat
145 mm

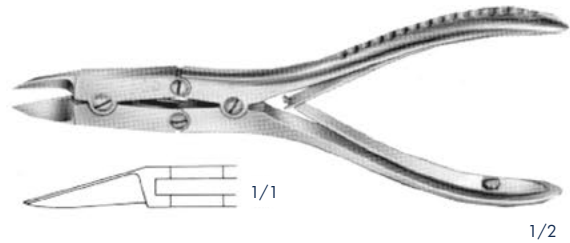

MCINDOE

OSI190848

Bone cutting forceps
175 mm

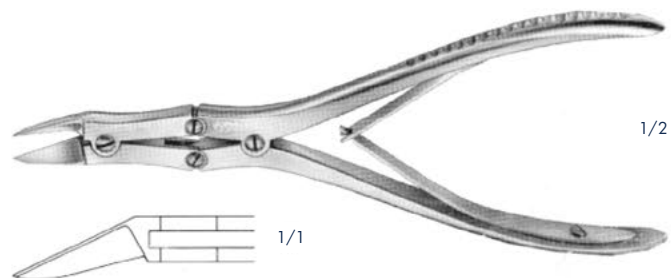

Ear Microsurgery

OSI250979 1/1
 Needle (perforator), straight, sharp point
 160 mm



OSI250980 1/1
 Needle, slightly curved, sharp point
 160 mm



OSI250981 1/1
 Needle, strongly curved, sharp point
 160 mm



ROSEN
OSI250156 1/1
 Hook, blackened finish
 160 mm



SHAMBAUGH
OSI250982 0,4 mm **OSI250984** 0,8 mm
OSI250983 0,6 mm **OSI250985** 1,0 mm
 Fenestre hook, 45° angled
 160 mm



SHAMBAUGH
OSI250986 0,4 mm **OSI250988** 0,8 mm
OSI250987 0,6 mm **OSI250989** 1,0 mm
 Fenestre hook, 90° angled
 160 mm



OSI250175 1,0 mm
 Footplate hook, retrograde curved, for adhesions,
 mesos, stapes and window
 160 mm



PLESTER
OSI250990 2,0 mm 1/1
 Scraper, 60° angled, for roughening of tympanum
 surface
 160 mm



Ear Microsurgery

OSI250991 0,4 mm 1/1
 Hook, reverse cutting
 160 mm



PLESTER
OSI250992 0,4 mm 1/1
 Footplate hook, 90° angled, oval-blunt
 160 mm



OSI250993 1/1
 Hook, straight shaft, slightly angled at tip
 160 mm



HOUGH
OSI250994 1/1
 Footplate hook 90° angled
 165 mm



BEALE
OSI250995 1/1
 Hook straight, angled upward for removal of footplate
 160 mm



PLESTER
OSI250996 1/1
 Antrum hook, 90° angled, cylindric
 160 mm



PLESTER
OSI250997 1/1
 Antrum hook, 45° angled, cylindric
 160 mm











PLESTER
OSI250998 1/1
 Wire guide and applicator for prosthesis, flat end with V-notch
 160 mm

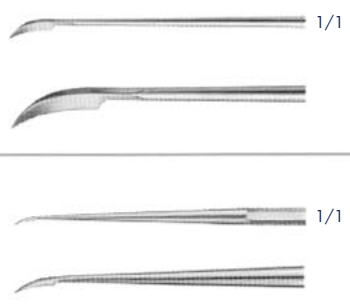

HUGHES
OSI250999 1/1
 Staples mobiliser
 165 mm

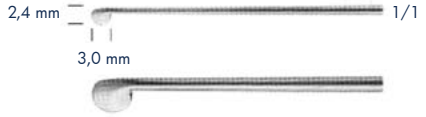

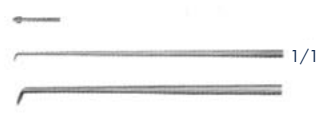
Ear Microsurgery

<p>OSI260212 Footplate knife, straight 160 mm</p>		1/1
<p>PLESTER OSI260213 Stickie knife, slightly curved 160 mm</p>		1/1
<p>THORBURN OSI260214 Stickie knife, curved tip 165 mm</p>		1/1
<p>BEALES OSI260215 Tendon knife 170 mm</p>		1/1
<p>OSI260216 2,4 mm x 3 mm Flap knife, round cutting, blade in line with shaft 160 mm</p>		1/1
<p>PLESTER OSI260145 2,4 mm x 3,5 mm Flap knife, round cutting, blade in line with shaft 160 mm</p>		1/1
<p>ROSEN OSI260217 Knife and elevator, spear pointed blade 160 mm</p>		1/1
<p>OSI260218 Ø 1,5 mm Round cutting knife, for incision of soft tissue, 45° angled, slender 160 mm</p>		1/1
<p>OSI260219 Ø 2,0 mm Round cutting knife, 45° angled 160 mm</p>		1/1

Ear Microsurgery



OSI260220 Ø 2,6 mm
Round cutting knife, 45° angled
160 mm



1/1

OSI260221 Ø 1,5 mm
Round cutting knife, 90° angled
160 mm

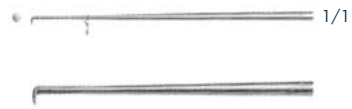

OSI260222 3 mm
Round cutting knife for incising skin of external
auditory meatus, 90° angled
160 mm



SCHUKNECHT

OSI250141
Roller knife, for incising skin of the bony external
auditory meatus, blade at right angle to shaft
160 mm



SCHUKNECHT

OSI250140
Roller knife, same as above,
but blade in line with shaft
160 mm

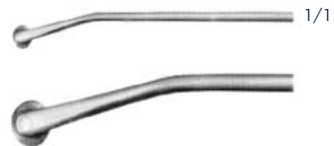

Ear Microsurgery

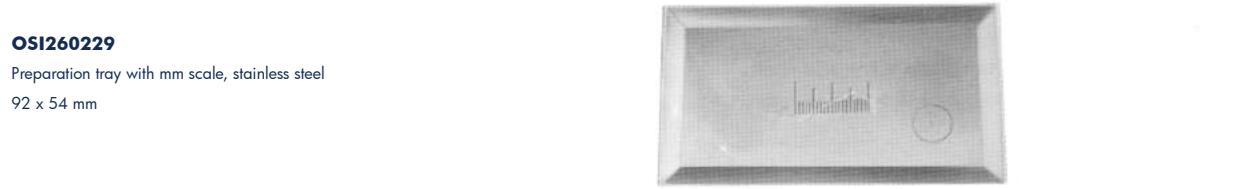
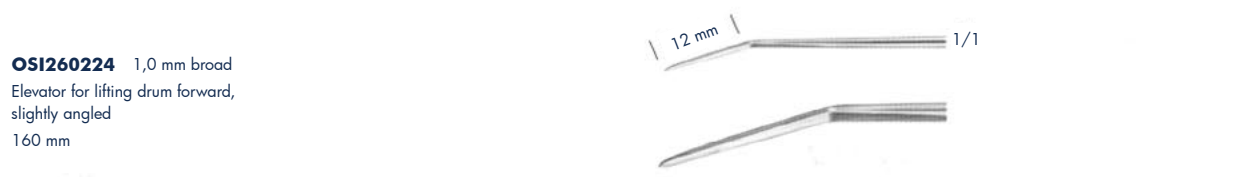
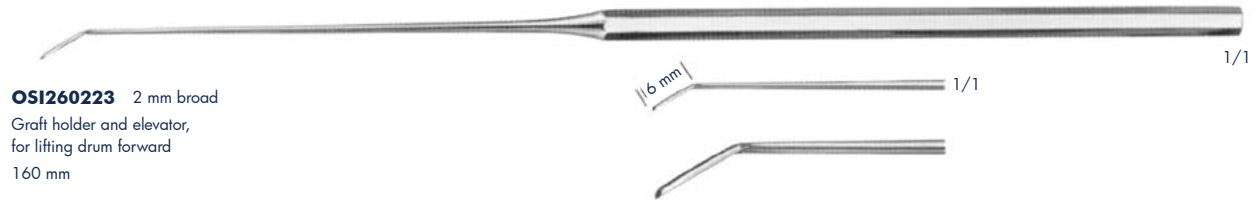

Ear Microsurgery

KING

OSI260230 Ø 20 mm

Vein graft, press forceps smooth round jaws
140 mm

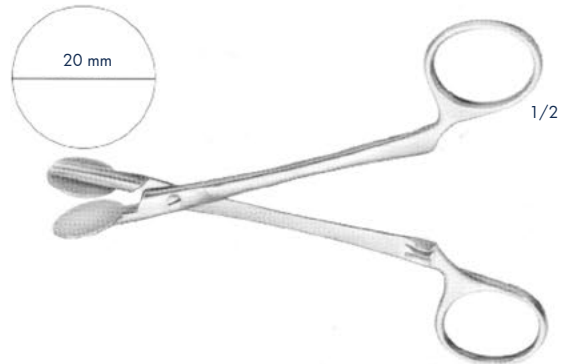

BEALES

OSI260231

Raspatory
165 mm



WULLSTEIN

OSI260232

Raspatory, rounded blade, curved
160 mm

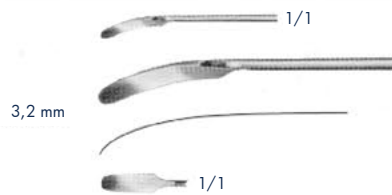

BEALES

OSI260233

OSI260234

Raspatory, spatula end, small
165 mm

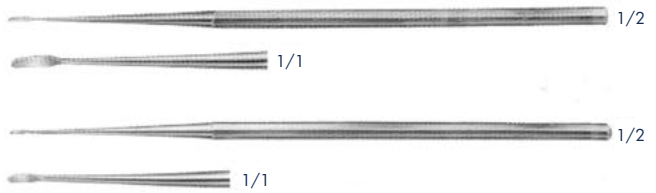

LEMPERT

OSI260235

Raspatory, narrow, straight
160 mm



OSI250963

OSI190701

curved
165 mm

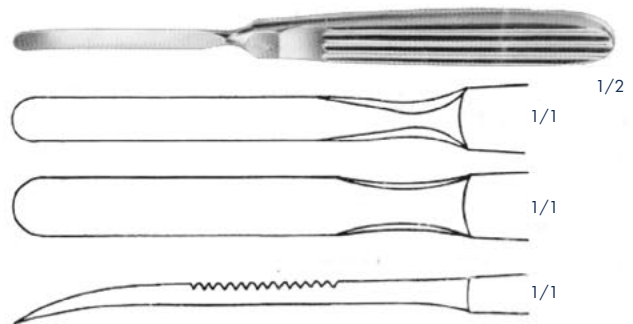

Ear Microsurgery



SHEA

OSI260236 1,5 x 2,5 mm

Curette, for tympanoplasty, oval cup, upward cutting with angled shaft

160 mm



SHEA

OSI260237 1,5 x 2,5 mm

Curette for tympanoplasty and myringoplasty, oval cups

160 mm



HOUSE

OSI250220 Ø 1,0 + 1,2 mm

OSI250221 Ø 1,5 + 1,8 mm

Curette, double ended, for stapedectomy, oval cups

150 mm



HOUSE

OSI250222 Ø 1,0 + 1,2 mm

OSI250223 Ø 1,5 + 1,8 mm

Curette, double ended, for stapedectomy, oval cups strongly angled

150 mm

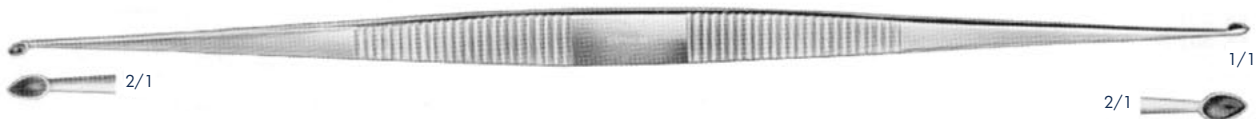

OSI260238

Curette, double ended, for stapedectomy, angled cups, pointed, large

170 mm

Ear Microsurgery

OSI260239 - OSI260245

Micro ear forceps with tubular shaft

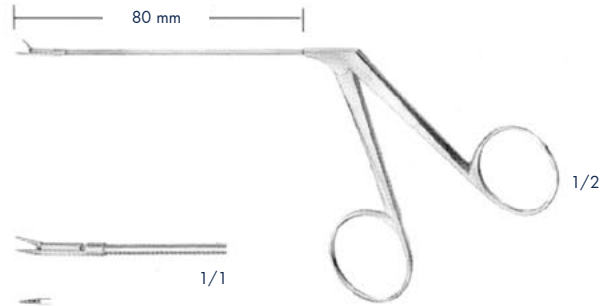

OSI260239 0,8 x 3,5 mm

Alligator forceps, straight

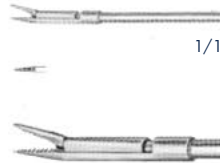

OSI260240 1 x 5 mm

Alligator forceps, straight

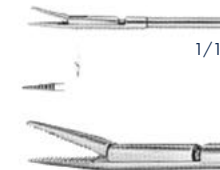

OSI260241 1,5 x 6,0 mm

Alligator forceps, straight

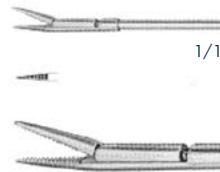

OSI260242 0,8 x 3,5 mm

Alligator forceps, curved up 65°

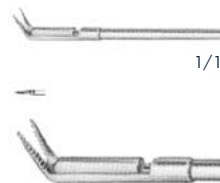

OSI260243 0,8 x 3,5 mm

Alligator forceps, curved down 45°

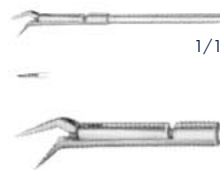

OSI260244 1 x 5 mm

Alligator forceps, curved to the left

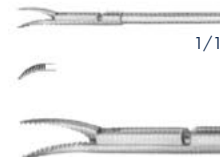

OSI260245 1 x 5 mm

Alligator forceps, curved to the right

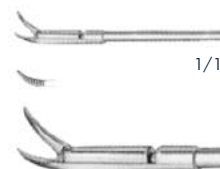

Ear Microsurgery

WULLSTEIN

OSI260246 - OSI260252

Micro cupped forceps with tubular shaft

OSI260246 0,9 x 1,0 mm

Micro cupped forceps, straight, oval jaw

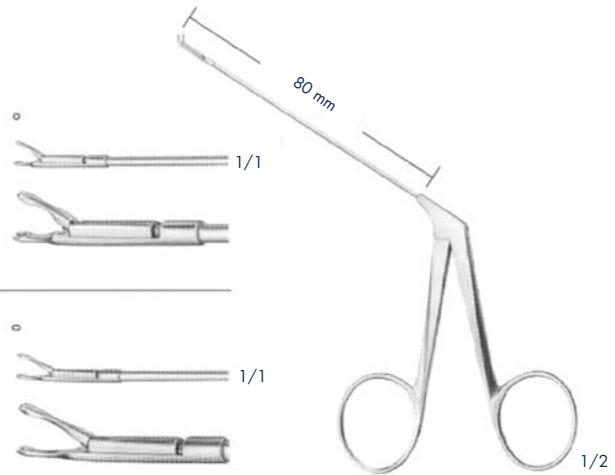

WULLSTEIN

OSI260247 0,8 x 1,3 mm

Micro cupped forceps, straight, oval jaw

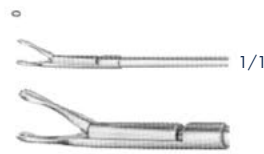

WULLSTEIN

OSI260248 Ø 1,0 mm

Micro cupped forceps, round jaw

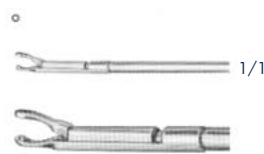

WULLSTEIN

OSI260249 1,7 x 2,5 mm

Micro cupped forceps, straight, oval jaw

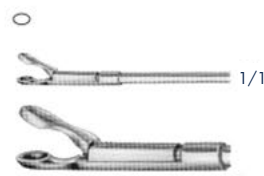

OSI260250 0,9 x 1,0 mm

Micro cupped forceps, curved up, oval jaw

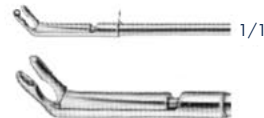

WULLSTEIN

OSI260251 0,8 x 1,3 mm

Micro cupped forceps, curved to the left, oval jaw

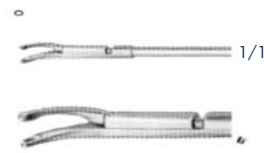

WULLSTEIN

OSI260252 0,8 x 1,3 mm

Micro cupped forceps, curved to the right, oval jaw

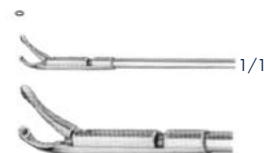

Ear Microsurgery

OSI260253 - OSI260257

Micro scissors with tubular shaft, micro punches with tubular shaft, micro wire bending forceps with tubular shaft

BELLUCCI

OSI260253

Micro Scissors, straight, sharp/sharp

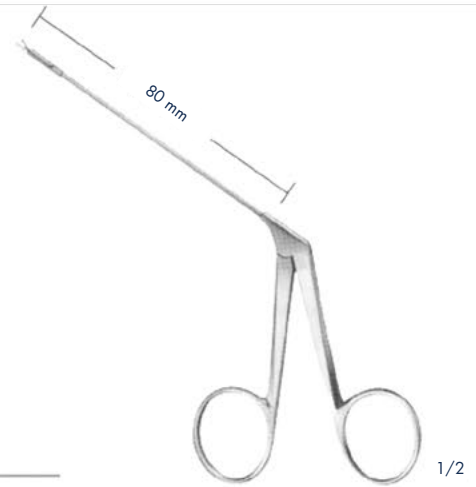

BELLUCCI

OSI260254

Micro Scissors, curved up, blunt/blunt

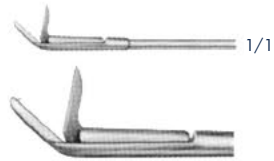

BELLUCCI

OSI260255

Micro scissors, curved to the left, sharp/sharp

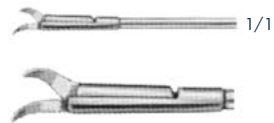

BELLUCCI

OSI260256

Micro scissors, curved to the right, sharp/sharp



BELLUCCI

OSI260257

Micro scissors, horizontal cutting



Ear Microsurgery

DIETER

OSI260258

Malleus nipper, upward cutting

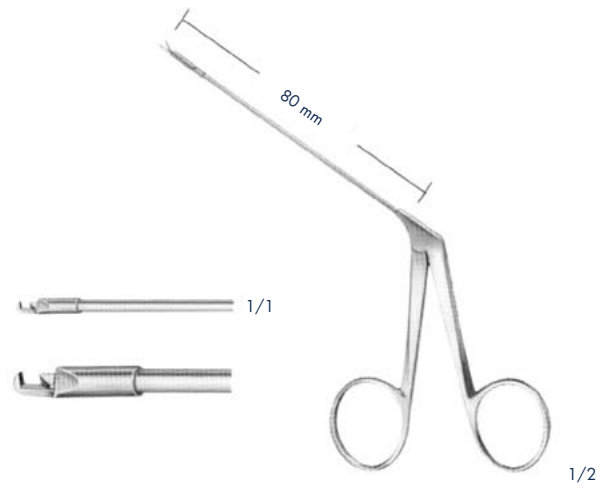

DIETER

OSI260259

Malleus nipper, downwards cutting

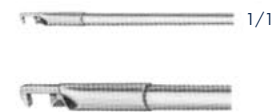

MCGEE

OSI260260

Wire bending forceps, curved down, jaw length 3,5 mm



MCGEE

OSI260261

Wire bending forceps, curved down, jaw length 5 mm

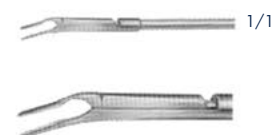

Ear Microsurgery

CAWTHORNE

OSI260262 4,0 mm x 1,5 mm
Micro scissors, straight, sharp/sharp

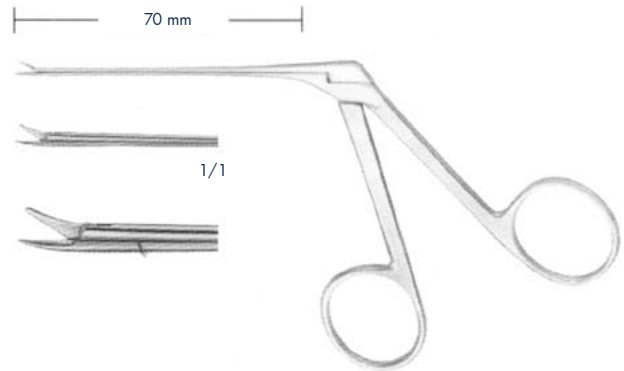

ORMEROD

OSI250948 4 mm
Aural forceps, round cup, straight

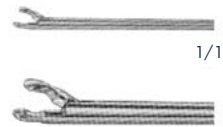

ORMEROD

OSI250949 5 mm x 1 mm
Aural forceps, oval cup, straight

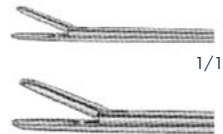

SHEA

OSI260263 4,0 mm x 0,8 mm
Aural forceps, oval cup, straight

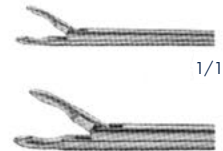

HOUGH

OSI260264 1 mm x 5 mm
Aural forceps, serrated jaws, straight

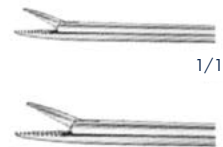

CAWTHORNE

OSI260265 1,25 mm x 7,0 mm
Aural forceps, straight, smooth jaws

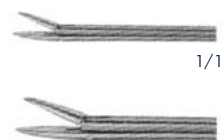

Ear Microsurgery

OSI270258 254 x 245 x 50 mm
Wire basket, can be stacked



OSI270101 285 x 280 x 100 mm
Half container with double lid



OSI260266
Rack for 6 each micro ear instruments with hexagonal or octagonal handle



OSI260267
Rack for approximately 8 micro ear forceps with ring handle



OSI260268 Ø 6 mm
Holding pin
Lange/Length 28 mm



OSI260269
Angle sheet irons (limiting bar) with securing screws, particularly useful on wire baskets and on wire bases



INSTRUMENT TRAY

OSI260270
Racked tray will hold 12 stapedectomy instruments



Ear Microsurgery

SCHUKNECHT

OSI260271

Wire bending die. This die is used to pre-form stainless steel wire prosthesis to produce the appropriate button hook shape for easy attachment to the incus. For accurate measuring the length of the prosthesis, millimeter scale is centered on the bending die



BECKMANN

OSI260272

Ear and nasal speculum curved sideways
150 mm

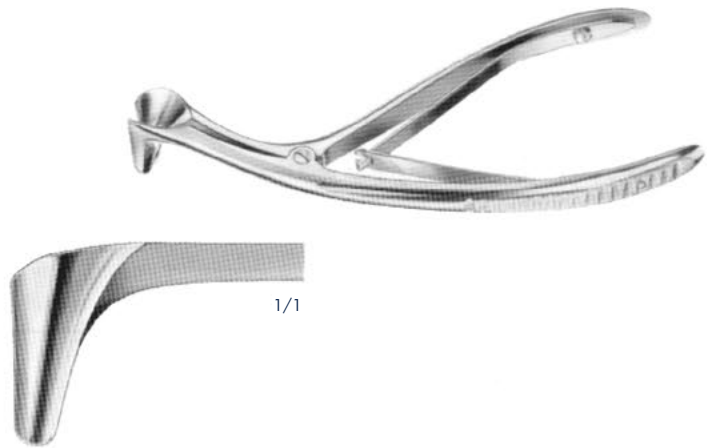

WILLIGER

OSI150549 straight

OSI150550 left curved

OSI150551 right curved

Wound retractor, sharp
120 mm

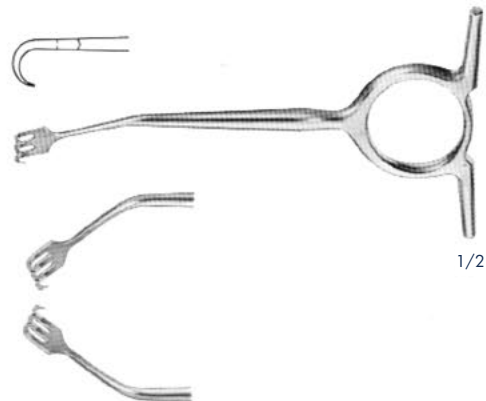

SEIFFERT

OSI160239 Ø 1 mm

Eustachian probe, silver
180 mm



Ear Microsurgery

HEERMANN

OSI260273 - OSI260277

Instruments for the removal of the stapedial footplate

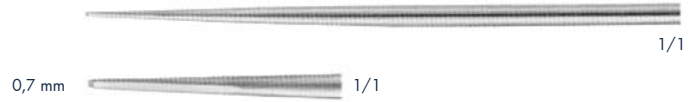

0,7 mm 1/1

OSI260273 0,7 mm

Chisel, very delicate

OSI260274 0,7 mm

Gouge very delicate



OSI260275 1,0 mm

Gouge for fenestration



OSI260276 1,5 mm

Gouge for fenestration



OSI260277 3,0 mm

Gouge for fenestration



OSI260278

Handle to hold instruments
The knurled screw allows fixation in any desired position



1/1

HEERMANN

OSI250232

Mallet, metal, with hollow handle, with narrow head
195 mm



1/2

OSI180194

Mallet, metal, lead filled head
165 mm



Ø 22 mm

1/2

Ear Microsurgery

VERHOEVEN

- OSI160382** Ø 16 swg, Ø 1,6 mm
- OSI160383** Ø 18 swg, Ø 1,2 mm
- OSI160384** Ø 20 swg, Ø 0,9 mm
- OSI160385** Ø 22 swg, Ø 0,7 mm
- OSI160386** Ø 24 swg, Ø 0,6 mm

Suction tubes
100 mm



1/2

HOUSE

OSI160387

Suction adapter with finger cut-off
55 mm

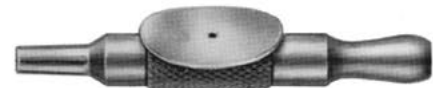

Olive 1/1
Ø 7 mm

OSI160360

Suction set complete, consisting of:

- OSI160361** suction handle, with finger cut-off, with LUER cone
- OSI160362** 2 suction cannulae, Ø 0,5 mm diameter, with LUER cone
- OSI160363** 2 suction cannulae, Ø 0,7 mm diameter, with LUER cone
- OSI160364** 2 suction cannulae, Ø 1,0 mm diameter, with LUER cone
- OSI160365** 2 suction cannulae, Ø 1,3 mm diameter, with LUER cone

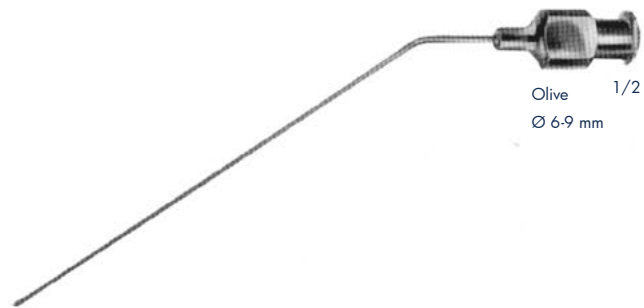

Olive 1/2
Ø 6-9 mm

ZOELLNER

OSI160371

Suction cannula only, with stylet, fitting to the detachable ends **OSI160368** and **OSI160373**
180 mm



Olive 1/2
Ø 8 mm

ZOELLNER

- OSI160372** Ø 18 swg, Ø 1,2 mm
- OSI160368** Ø 20 swg, Ø 0,9 mm
- OSI160369** Ø 22 swg, Ø 0,7 mm
- OSI160370** Ø 24 swg, Ø 0,6 mm
- OSI160373** Ø 26 swg, Ø 0,4 mm

Detachable ends, fitting to
100 mm

Sales unit: PZ = Package of 10 pieces



1/1

SCHUHKNECHT

OSI160353 Ø 20 swg, Ø 0,9 mm

OSI160354 Ø 24 swg, Ø 0,6 mm

Suction cannula

130 mm



BELLUCCI

OSI160366

Suction set complete, consisting of:

OSI160367 Suction tube with finger cut-off and stylet, 155 mm

OSI160368 Detachable end, Ø 20 swg, Ø 0,9 mm

OSI260279 Detachable end, Ø 22 swg, Ø 0,7 mm

OSI160370 Detachable end, Ø 24 swg, Ø 0,6 mm

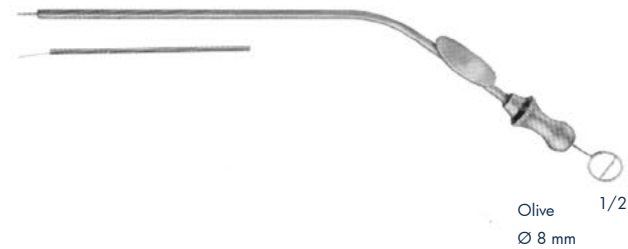

WULLSTEIN

OSI160355 6-10 mm

Micro-suction tube, complete, consisting of:

OSI160356 Suction tube with LUER huc

OSI160357 Micro suction cannula, Ø 0,4 mm

OSI160358 Micro suction cannula, Ø 0,6 mm

OSI160359 Micro suction cannula, Ø 0,8 mm

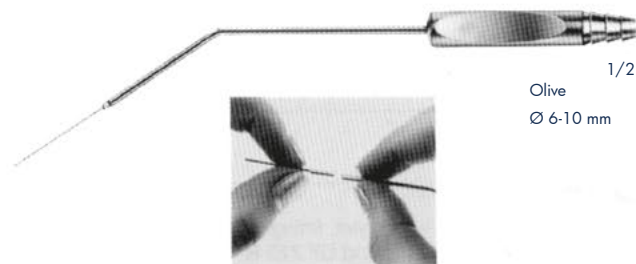

FERGUSON

Ø	110 mm	130 mm	160 mm	200 mm
1,5 mm	OSI260280	OSI260286	OSI260292	OSI260298
2 mm	OSI260281	OSI260287	OSI260293	OSI260299
2,5 mm	OSI260282	OSI260288	OSI260294	OSI260300
3 mm	OSI260283	OSI260289	OSI260295	OSI260301
4 mm	OSI260284	OSI260290	OSI260296	OSI260302
5 mm	OSI260285	OSI260291	OSI260297	OSI260303

Suction cannula with finger cut-off and stylet, thumb piece 90° to curve, with LUER hub

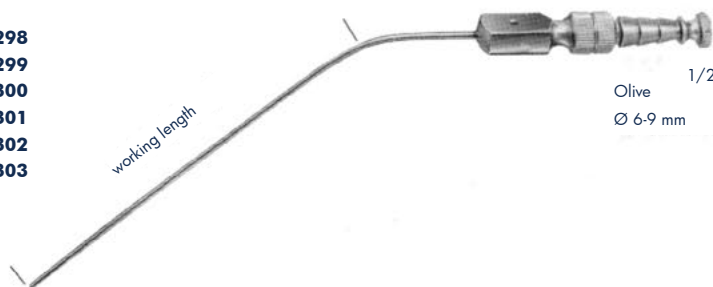

Rhinology

SHAH

OSI220304 30 mm x 50 mm
Nasal speculum, insulated,
right blade 30 mm/left blade
50 mm

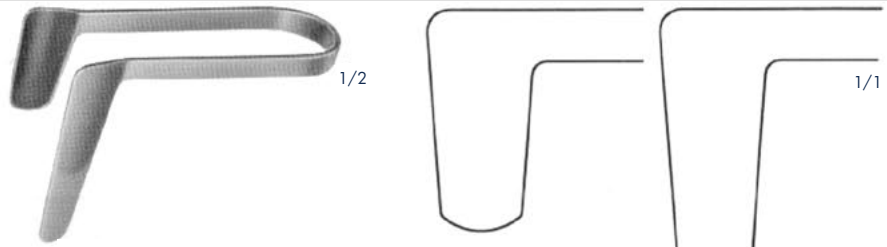

OSI220304

75 mm

SHAH

OSI220305 50 mm x 30 mm
Nasal speculum, insulated,
right blade 50 mm/left blade
30 mm

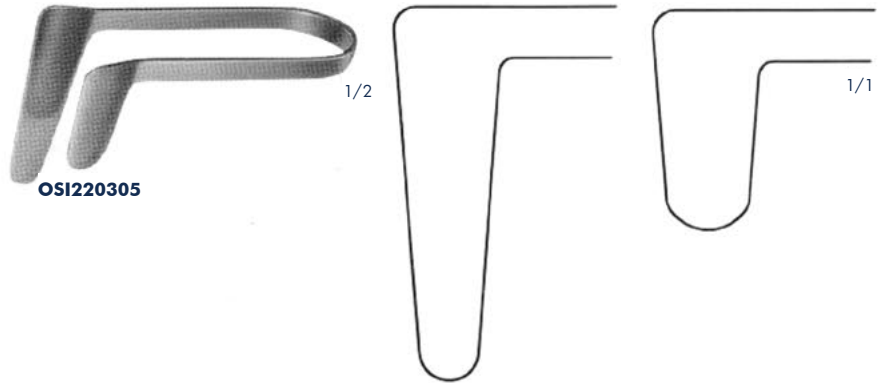

OSI220305

75 mm

THUDICHUM (MARK HOVELL)

OSI260306 8,5 x 6,0, 70 mm
OSI260307 9,0 x 7,0, 71 mm
OSI260308 12,5 x 8,0, 72 mm
OSI260309 15,0 x 8,5, 73 mm
OSI260310 16,5 x 9,0, 74 mm
OSI260311 18,0 x 10,0, 74 mm
OSI260312 19,5 x 10,5, 75 mm

Nasal Specula

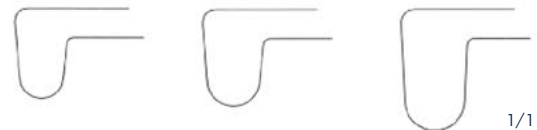
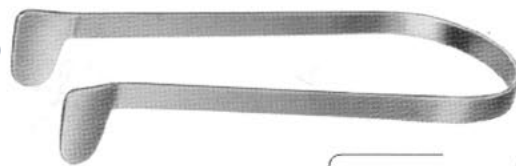

OSI260306 **OSI260307** **OSI260308**
OSI260313 **OSI260314** **OSI260315**

OSI260313 8,5 x 6,0, 70 mm
OSI260314 9,0 x 7,0, 71 mm
OSI260315 12,5 x 8,0, 72 mm
OSI260316 15,0 x 8,5, 73 mm
OSI260317 16,5 x 9,0, 74 mm
OSI260318 18,0 x 10,0, 74 mm
OSI260319 19,5 x 10,5, 75 mm

Nasal Specula, insulated

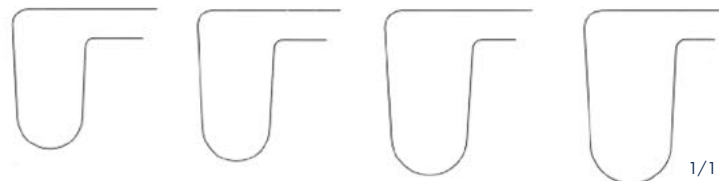

OSI260309 **OSI260310** **OSI260311** **OSI260312**
OSI260316 **OSI260317** **OSI260318** **OSI260319**

TIECK-HALLE

Nasal specula, aseptic joint, for use
in infants
135 mm



OSI260320

OSI250399

Rhinology

HARTMANN-HALLE

OSI250393
OSI250394
OSI250395

Nasal specula, aseptic joint
155 mm

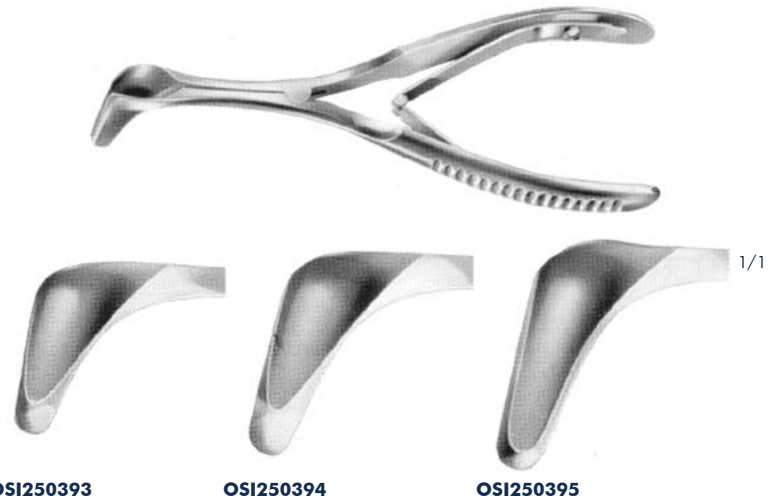

HARTMANN-HALLE

OSI260321
OSI260322
OSI260323

Nasal specula, screw joint
155 mm

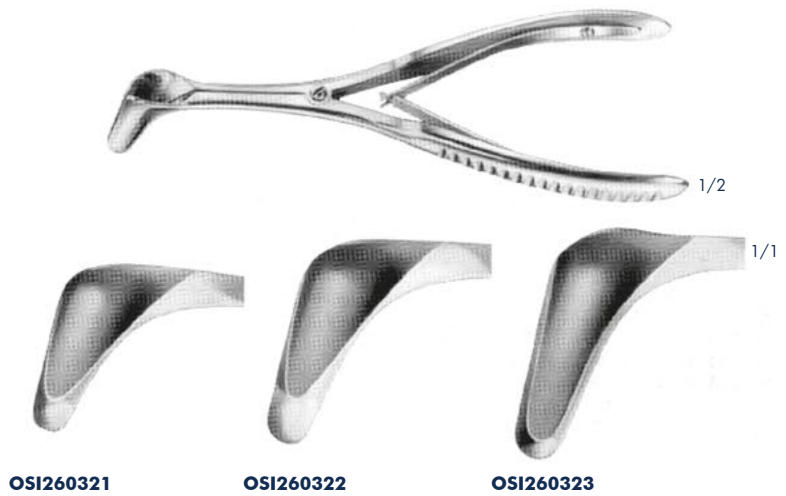

TECK-HALLE

OSI260324
OSI250398

Nasal specula, screw joint, for use in infants, curved sideways
135 mm

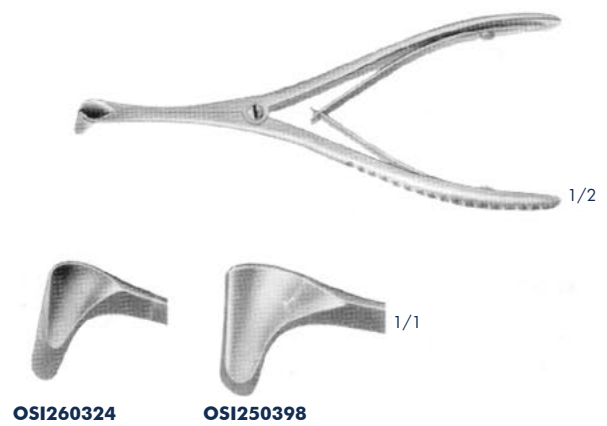

Rhinology

BECKMANN

OSI260325

Nasal specula, screw joint, for use in infants, curved sidwards
140 mm

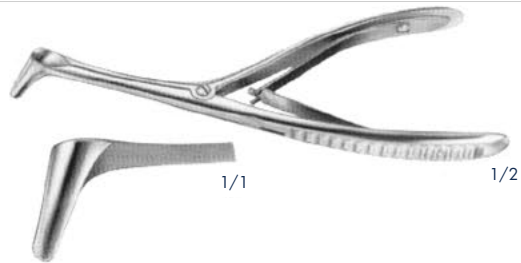

BECKMANN

OSI260272

Nasal specula, screw joint, curved sidwards
150 mm

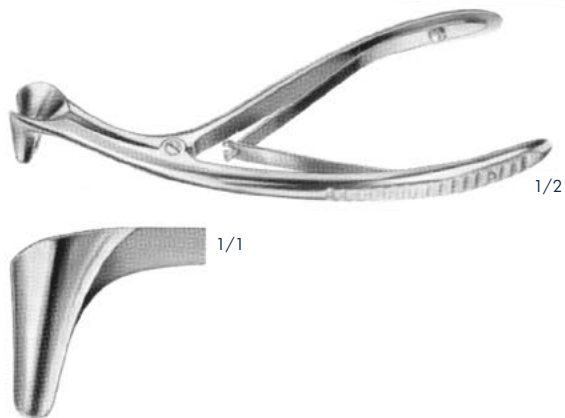

HARTMANN

OSI260327

OSI260328

OSI260329

Nasal specula, screw joint
160 mm

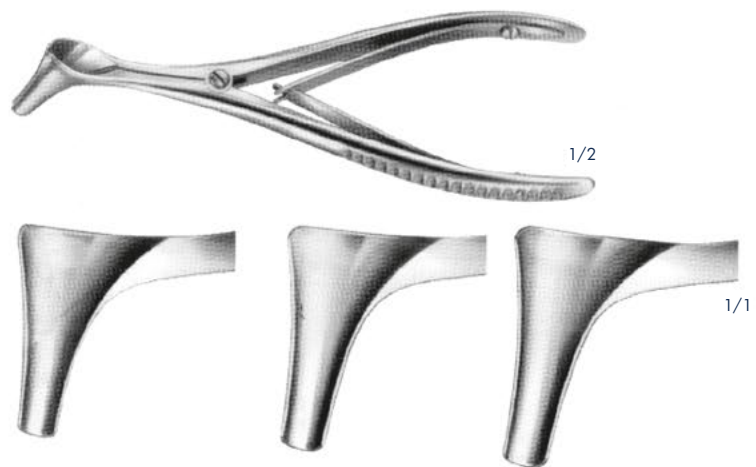

WIENER MODELL

OSI260330

Nasal specula, screw joint, small, light pattern
140 mm

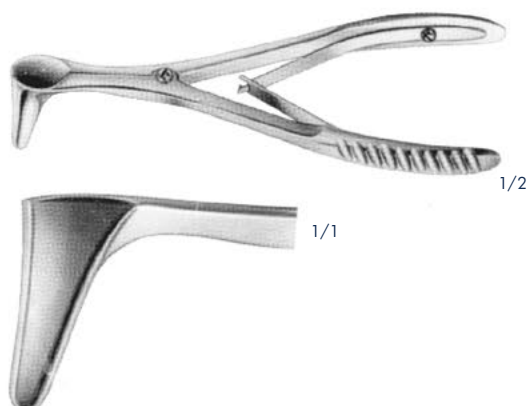

WIENER MODELL

OSI260331

Nasal specula, screw joint, medium pattern
140 mm

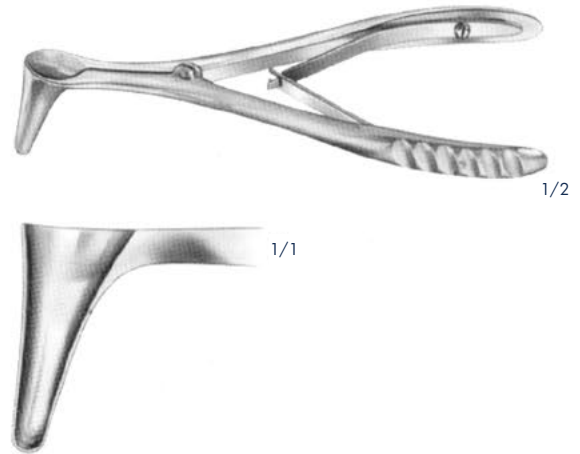

WIENER MODELL

OSI250404

Nasal specula, screw joint, heavy pattern
140 mm

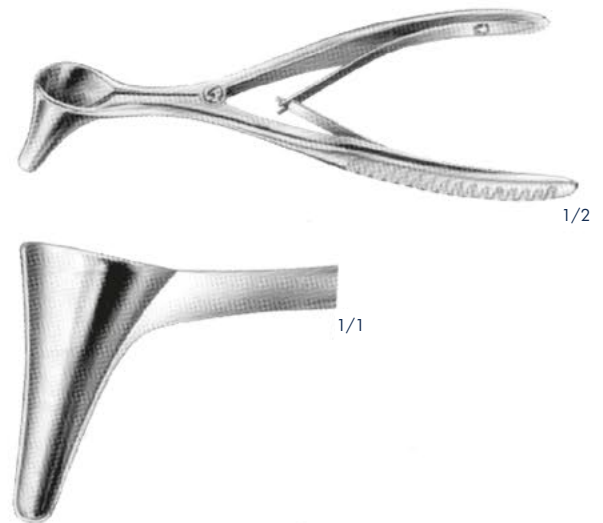

HARTMANN

OSI260332

Nasal specula, light pattern
145 mm

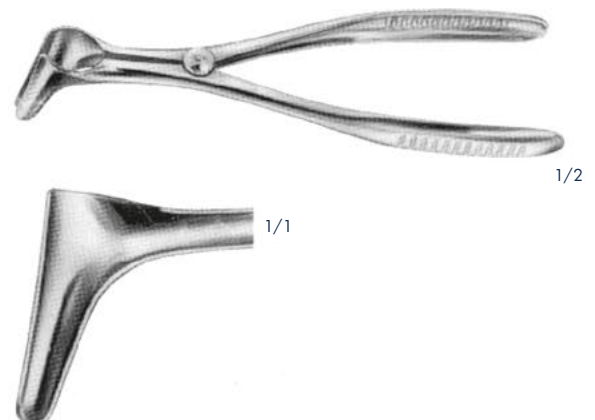

Rhinology

KILLIAN

OSI260333 Fig. 1 36 x 7 mm

OSI260334 Fig. 2 56 x 7 mm

OSI260335 Fig. 3 75 x 7 mm

OSI260336 Fig. 4 90 x 7 mm

Septum specula, aseptic joint

145 mm

OSI250400 Fig. 1 36 x 7 mm

OSI250401 Fig. 2 56 x 7 mm

OSI250402 Fig. 3 75 x 7 mm

OSI250403 Fig. 4 90 x 7 mm

Septum specula, aseptic joint

140 mm

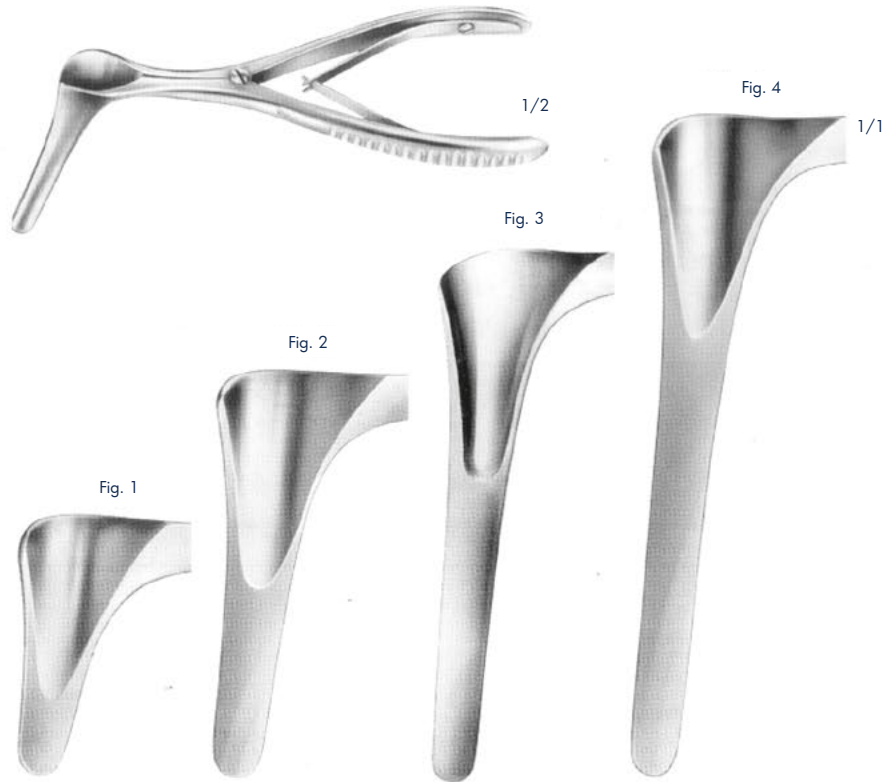

COTTLE

OSI260337 Fig. 1 20 mm

OSI260338 Fig. 2 38 mm

OSI260339 Fig. 3 41 mm

OSI260340 Fig. 4 60 mm

OSI260472 Fig. 5 76 mm

OSI260473 Fig. 6 90 mm

Septum specula, aseptic joint,
set-screw, with extra thin blades

135 mm

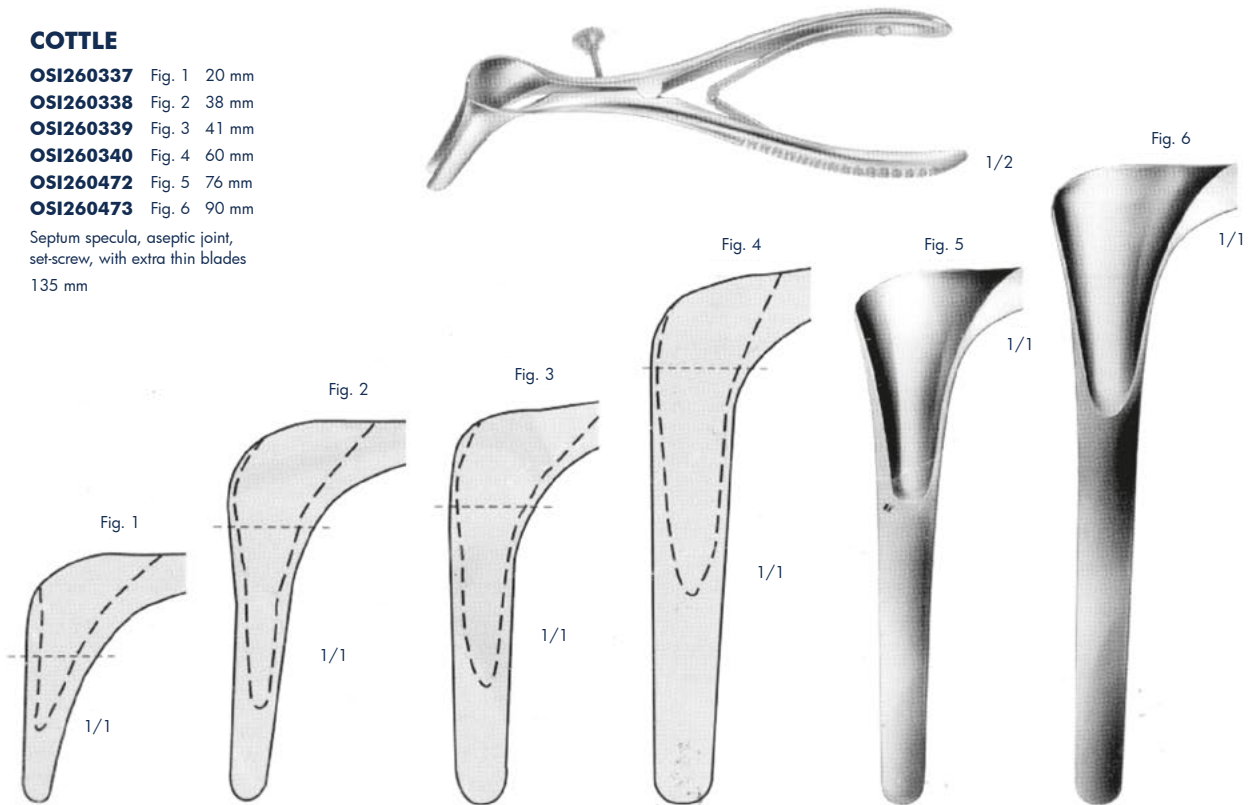

Rhinology

COTTLE

OSI260341 50 x 6 mm
Septum specula, slightly tapered blades
135 mm



ST CLAIR THOMPSON

OSI260342 38 mm
OSI260343 50 mm
OSI260344 65 mm
OSI260345 75 mm
Nasal specula
73 mm



OSI260342



OSI260344



OSI260343

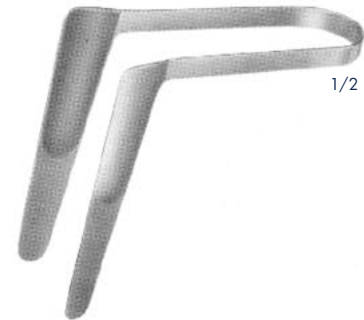

OSI260345

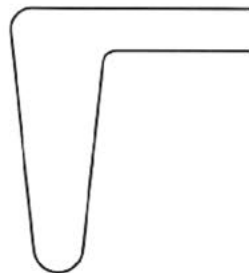

OSI260342

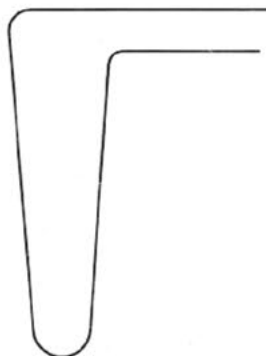

OSI260343

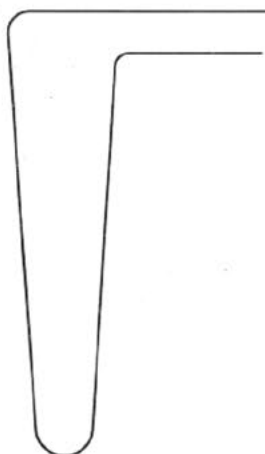

OSI260344

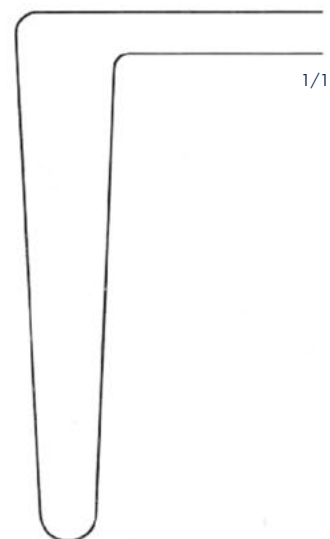

OSI260345

Rhinology

KILLIAN

OSI260346 51 mm

OSI260347 62 mm

OSI260348 76 mm

OSI260349 89 mm

Nasal specula, fibre optic, Universal fitting
135 mm

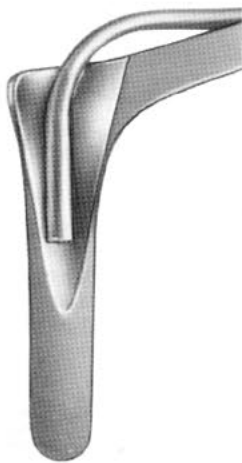

OSI260346

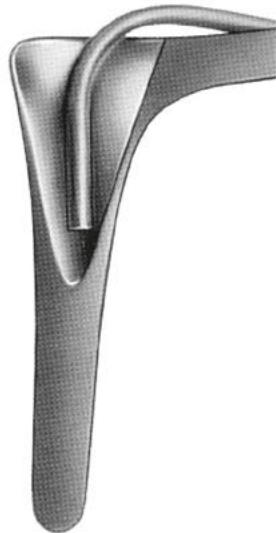

OSI260347



OSI260348



OSI260349

1/1

ST CLAIR THOMPSON

OSI260350 6 mm

OSI260351 8 mm

OSI260352 10 mm

OSI260353 12 mm

OSI260354 14 mm

OSI260355 16 mm

Rhinoscopic mirrors, round angled, bayonet shaft
245 mm

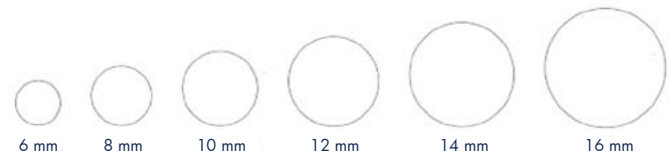

LISTER

OSI140134

Dressing forceps

155 mm

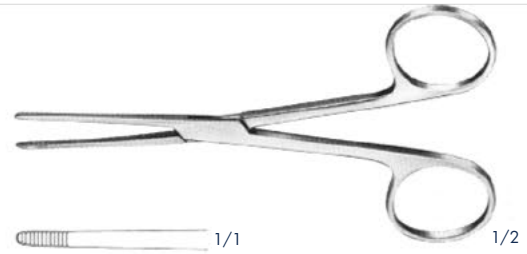

TILLEY

OSI260356 2,2 mm

Nasal dressing forceps

132 mm

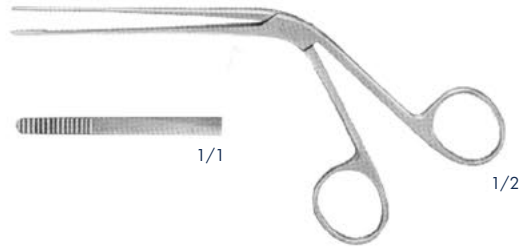

LUBET-BARBON

OSI250421

Nasal dressing forceps

200 mm

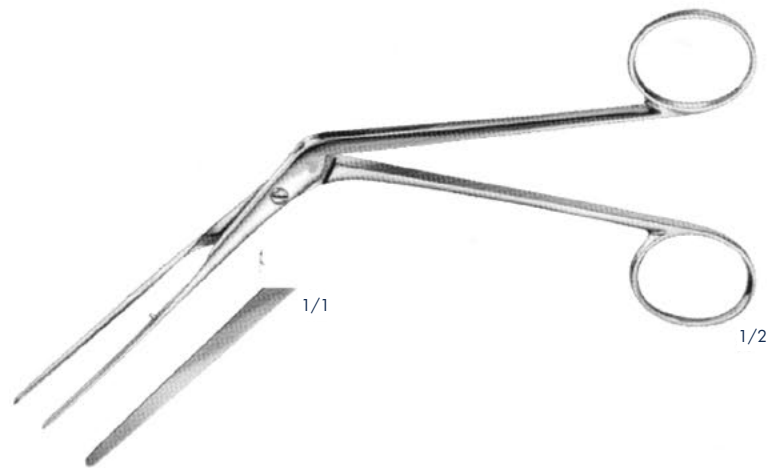

WEST

AS250420

Nasal dressing forceps

200 mm

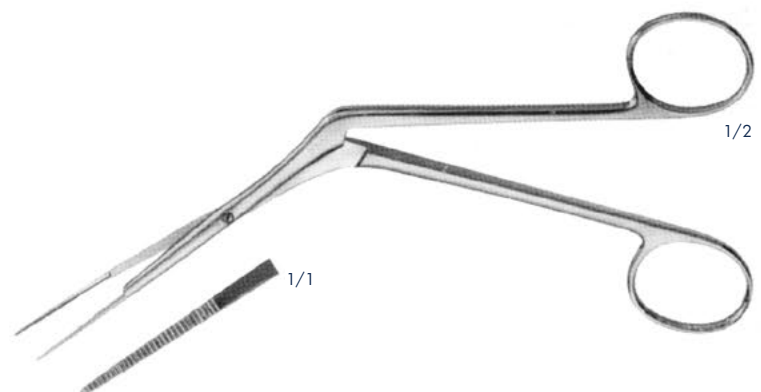

Rhinology

HARTMANN

OSI250422

Nasal dressing forceps

175 mm

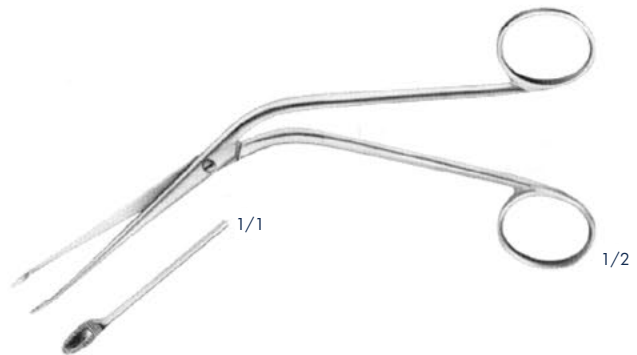

HARTMANN

OSI250424

Nasal dressing forceps

215 mm

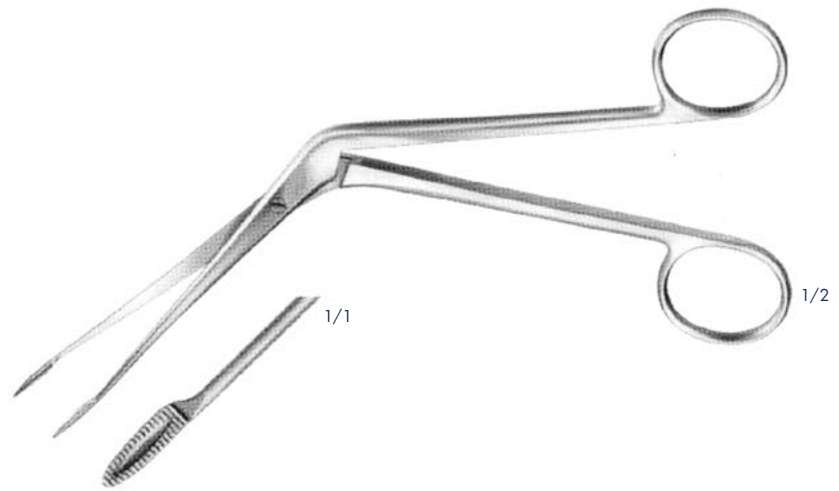

HARTMANN

OSI260357

Nasal dressing forceps

190 mm

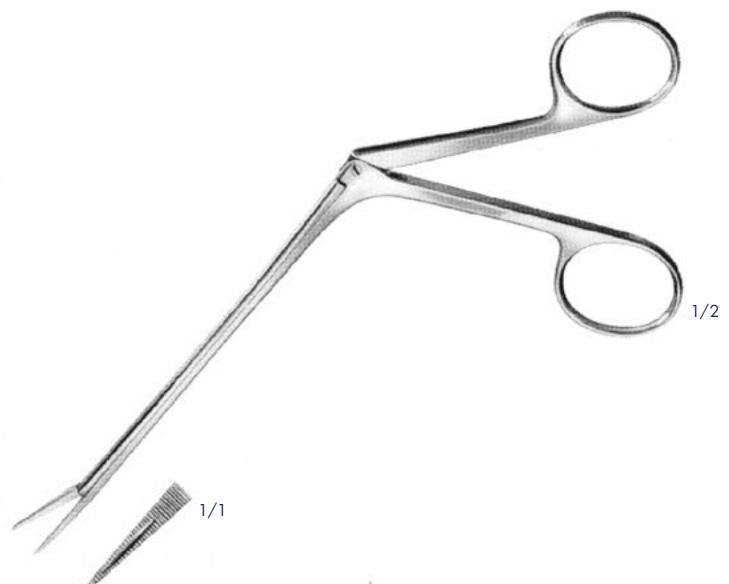

Rhinology

TROELTSCH (WILDE)

OSI250417

Nasal dressing forceps, angled
140 mm

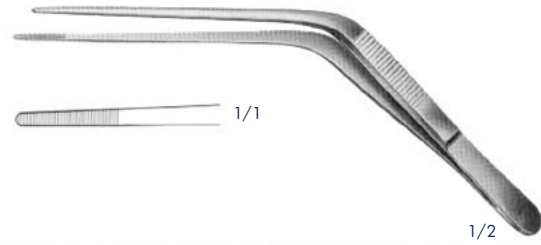

TROELTSCH (WILDE)

OSI250418

Nasal dressing forceps, angled
170 mm

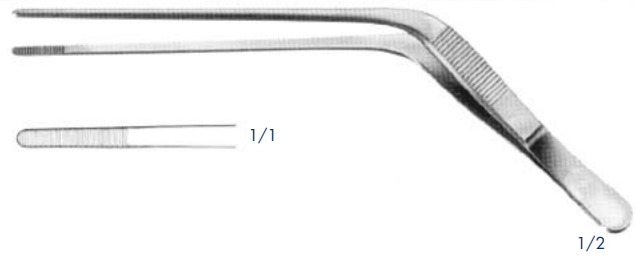

JANSEN

OSI250273

Nasal dressing forceps, bayonet shaped
160 mm

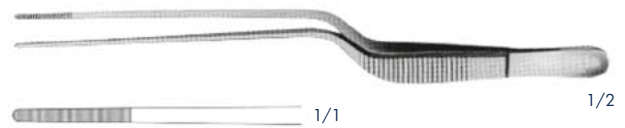

GRUENWALD

OSI250419

Nasal dressing forceps, bayonet shaped
200 mm

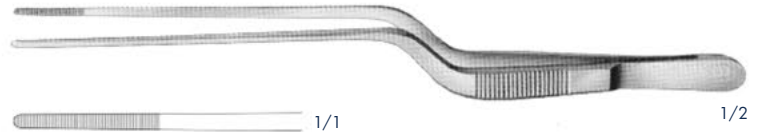

OSI260358

Nasal dressing forceps, bayonet shaped, 1x 2 teeth
200 mm



OSI160238

Nasal probe, angled
160 mm



KILLIAN

OSI160237

Nasal probe, slightly curved
165 mm



Rhinology

OSI160254 Ø 1,5 mm
OSI160255 Ø 1,8 mm
 Nasal applicator, rough spiral end
 180 mm

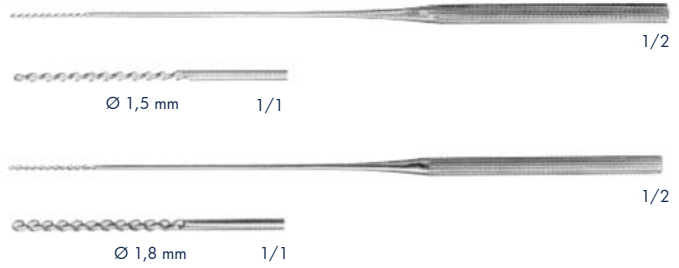

LOGAN TURNER

OSI160248 Ø 1 mm
 Nasal probe
 133 mm

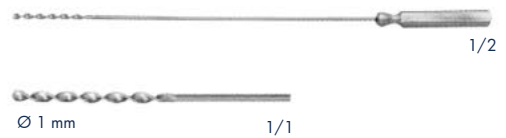

FARREL

OSI260359 Ø 1,2 mm
 Nasal applicator, rough spiral end
 160 mm

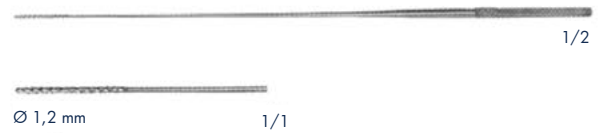

OSI160253 1,4 mm
 Nasal applicator, triangular serrated end
 160 mm

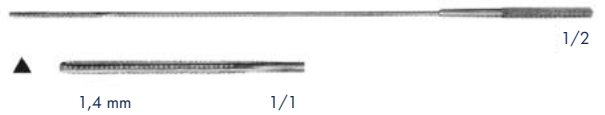

LATHBURY-FARREL

OSI160252 1,2 mm
 Nasal applicator, triangular serrated end
 160 mm

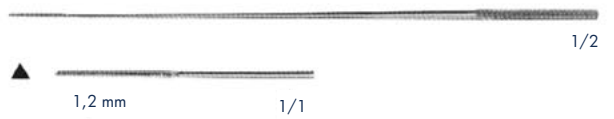

LANGE

OSI250616
 Choana hook
 230 mm



KINGS COLLEGE HOSPITAL

OSI160249
 Cocainising wire
 89 mm

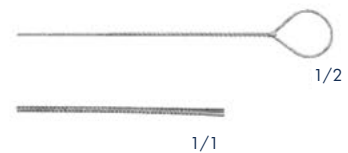

KINGS COLLEGE HOSPITAL

OSI160250
 Cocainising wire
 133 mm

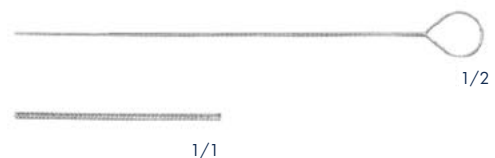

Rhinology

KRAUSE

OSI250412

Nasal polypus snare, angled
250 mm

OSI260360

Tube only



1/2

OSI260361

Wire guide only

KRAUSE-VOSS

OSI250413

Nasal polypus snare, angled, complete with tube vertical tube horizontal
250 mm

OSI260362

Tube with wire guide only, vertical

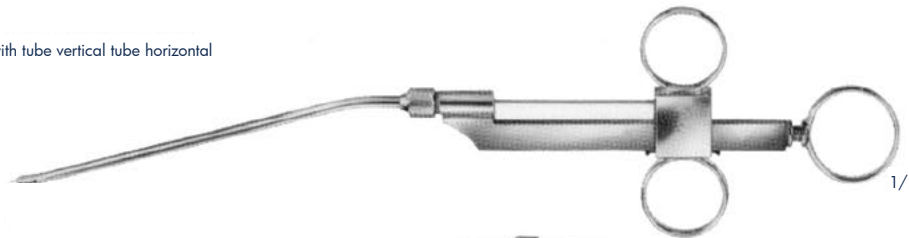

1/2

OSI260363

Tube with wire guide only, horizontal



WILDE

OSI260364

Nasal polypus snare, bayonet shaped
250 mm

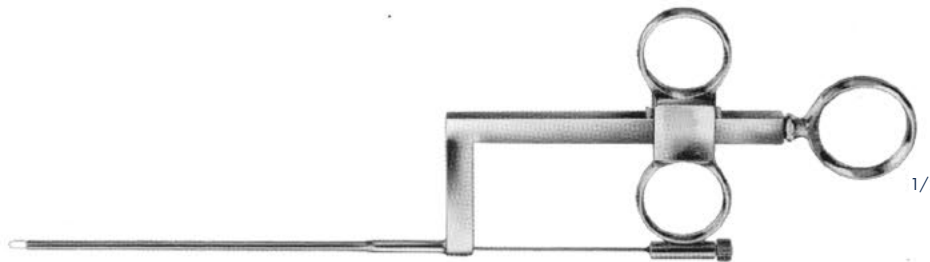

1/2

OSI260365

 Ø 0,3 mm

Wire loops for nasal snares,
sales unit : PH = Package of 100 pieces

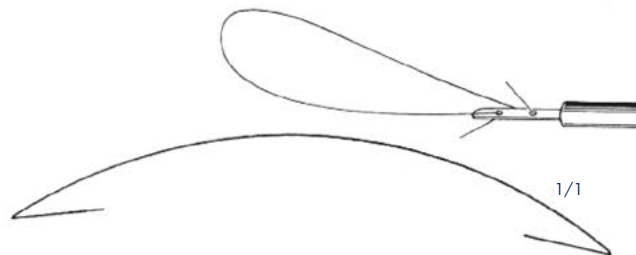

1/1

OSI250414

 Ø 0,3 mm

Snare wire in coils of 10 metres



Rhinology

FREER

OSI250513

Mucous knife

155 mm



BRÜNING

OSI250524

Septatome

160 mm



OSI260366

Spare blade for

HALLE

OSI250527 3,3 mm

Elevator, blunt

180 mm

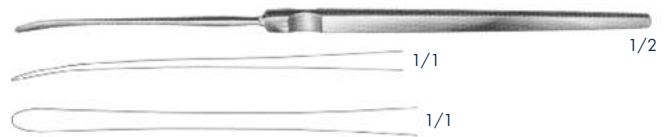

FREER

OSI250529 4 mm

Raspatory, sharp

190 mm

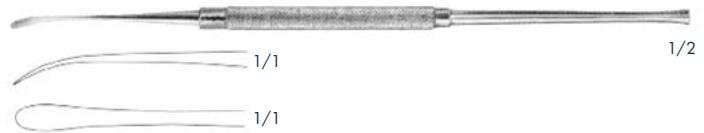

FREER

OSI250530 4 mm

Elevator, blunt

190 mm



FREER

OSI260367

Elevator, curved to the side

190 mm



FREER

OSI260368

Raspatory, sharp

175 mm



Rhinology

FREER

OSI260369

Elevator, sharp/blunt

185 mm

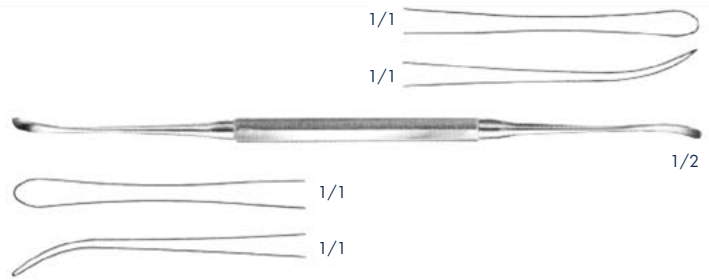

FREER-YASARGIL

OSI260370

Dissector, sharp

185 mm

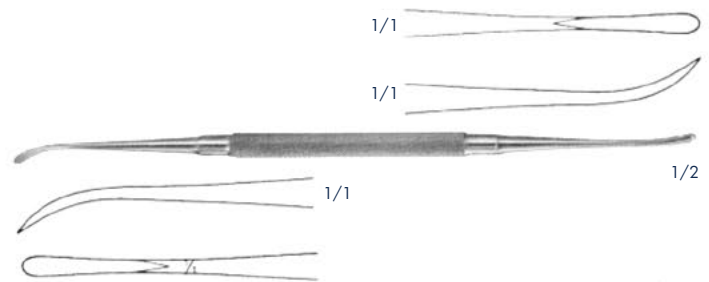

KILLIAN

OSI260371

Elevator, sharp/blunt

180 mm

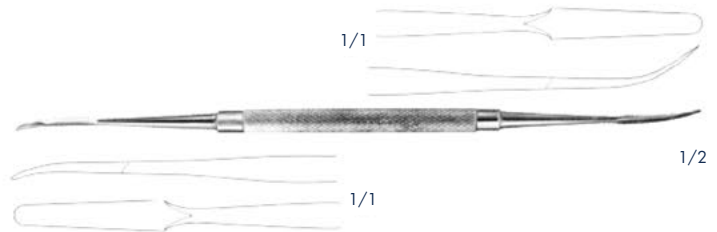

HILL

OSI190680

Elevator, semi-sharp/blunt

220 mm



MAC DONALD

OSI190676

Dissector, blunt/blunt

190 mm

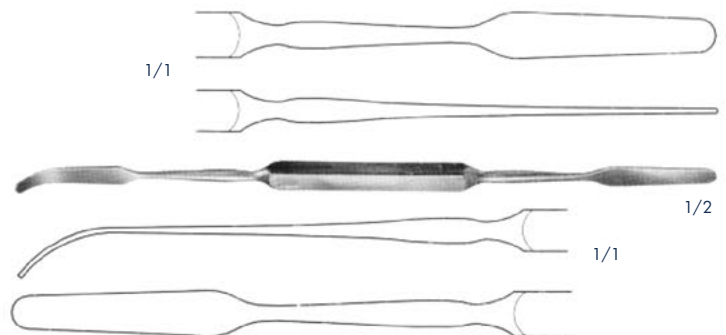

Rhinology

WATSON-CHEYNE

OSI190677

Raspatory
130 mm

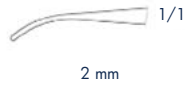

OSI190677



OSI190678

Raspatory
190 mm

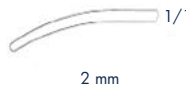

OSI190678



KILLIAN

OSI260373

Elevator, sharp/blunt
185 mm

1/1



1/2



1/1

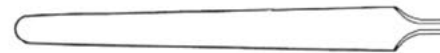

NEGUS

OSI160423 6 mm

Suction dissector
210 mm



Olive
Ø 6 mm

1/2

NEGUS

OSI260374

Suction dissector, insulated
210 mm
HF Cables see leaflet



Olive
Ø 6 mm

1/2

Ø 4 mm

HOWARTH

OSI190675

Elevator
215 mm

1/1



1/2



1/1



FREER

OSI190679

Separator and elevator
180 mm



1/2



4 mm 1/1



Rhinology

FREER

OSI250548 6 mm

Septum gouge, straight, round cutting edge
150 mm



BALLENGER

OSI260375 6 mm

Septum gouge, with notch and cutting edge
155 mm



KILLIAN-CLAUS

OSI250550 6 mm

Septum gouge with notch, bayonet shaped
170 mm



KILLIAN

OSI250549 6 mm

Septum gouge, round cutting edge, bayonet shaped
170 mm

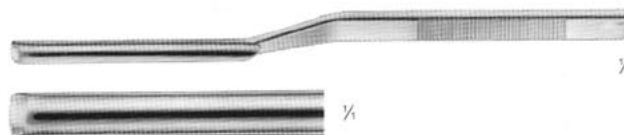

OSI180190 135 g

Mallet head with interchangeable plastic disks
185 mm

OSI180191

Pair of spare disks for mallet

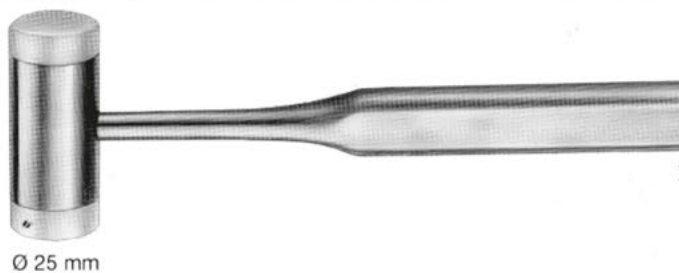

COTTLE

OSI180192 235 g

Mallet 1 plain flat, 1 convex
185 mm

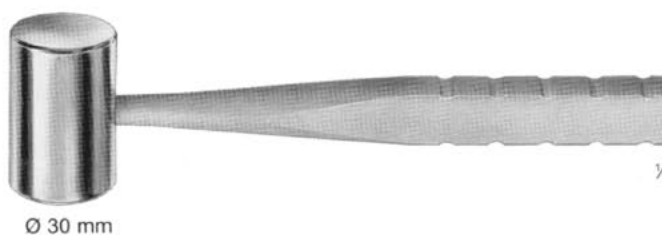

Rhinology

FRANCIS ALAE-NOSI

- OSI260376** 11 mm x 15 mm
 - OSI260377** 12 mm x 16 mm
 - OSI260378** 13 mm x 17 mm
 - OSI260379** 14 mm x 18 mm
 - OSI260380** 15 mm x 19 mm
- Nasal dilators, silver



BALLENGER

- OSI250518** 4 x 3 mm
- Swivel knife, straight
203 mm



BALLENGER

- OSI250521** 4 x 3 mm
 - OSI250522** 5 x 4 mm
 - OSI250523** 6 x 5 mm
- Swivel knife, bayonet shaped
210 mm

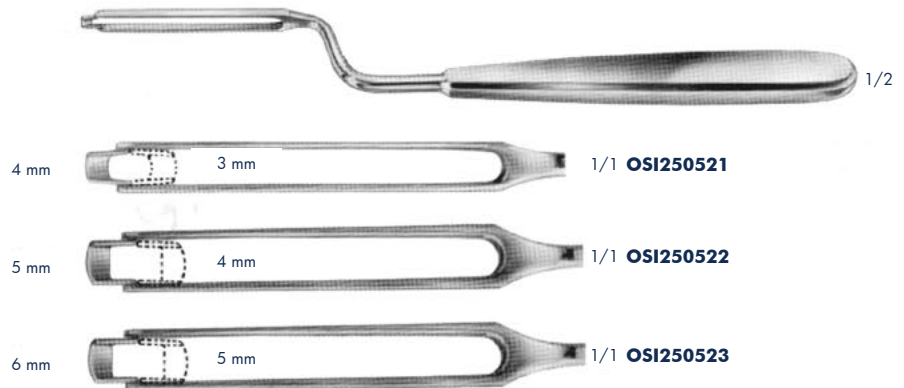

JANSEN-MIDDLETON

- OSI250475**
- Nasal forceps, spoon-shaped, biting
200 mm



JANSEN-MIDDLETON

- OSI250474**
- Nasal forceps, through cutting
210 mm

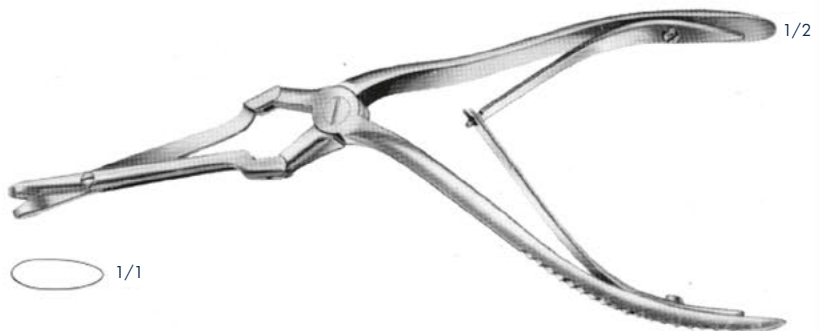

Rhinology

KRESSNER

OSI250645 3 mm

OSI260381 4 mm

Crushing forceps

220 mm

3 mm

4 mm

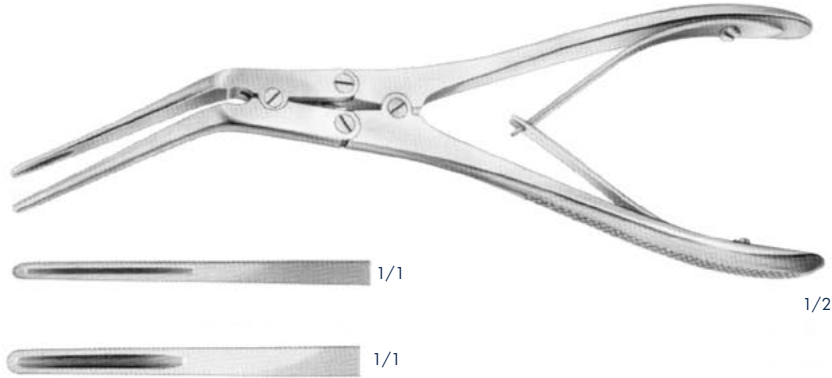

1/2

CRAIG

OSI250432

Septum bone cutting and breaking forceps curved to the left, sharp spoons

165 mm

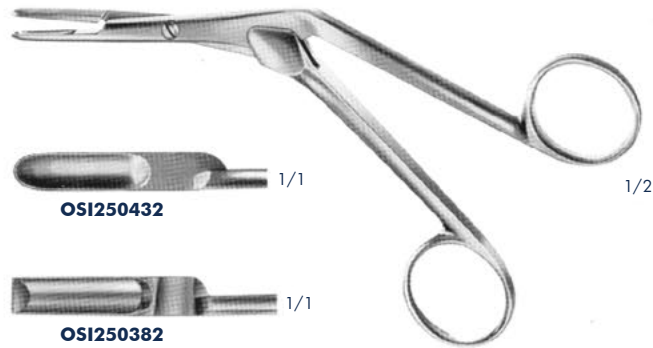

1/2

CRAIG

OSI260382

Septum bone cutting and breaking forceps curved to the left, sharp spoons

165 mm

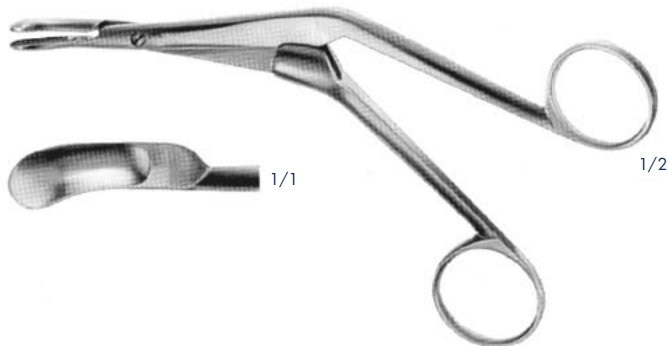

1/2

CRAIG-DOMNICK

OSI250433

Septum bone cutting and breaking forceps curved to the left, sharp spoons

165 mm

HEYMANN-KNIGHT

OSI250431

Septum forceps, with sharp oval spoons

190 mm

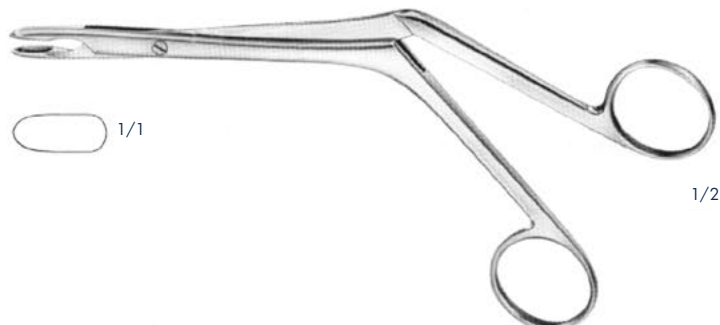

1/2

Rhinology

MYLES

OSI250466

Nasal cutting forceps, through cutting

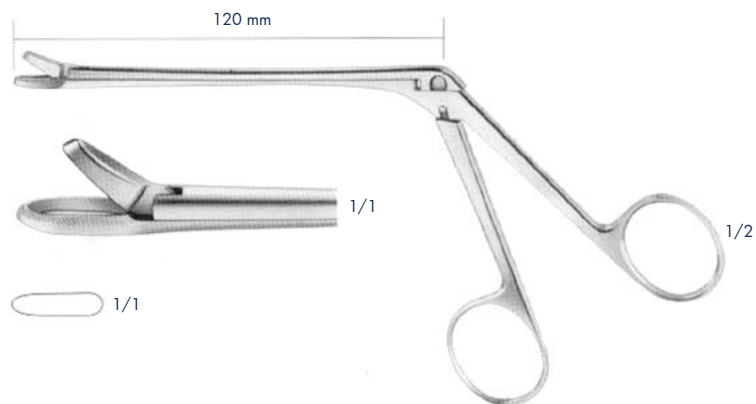

GRUENWALD-HENKE

OSI260383

OSI260384

Nasal cutting forceps, through cutting

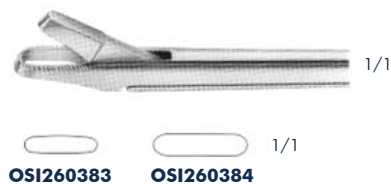

HARTMANN

OSI250468

OSI250469

OSI250470

OSI250471

Nasal cutting forceps, through cutting

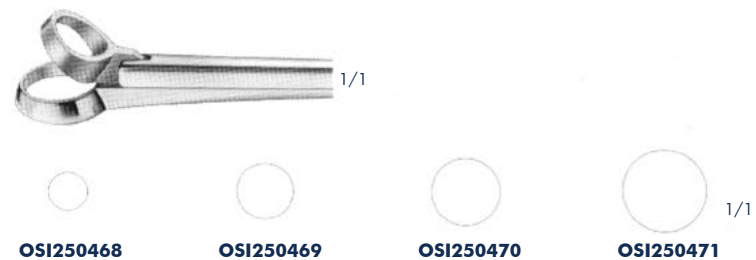

SCHMEDEN

OSI250472

OSI260385

Nasal cutting forceps, through cutting

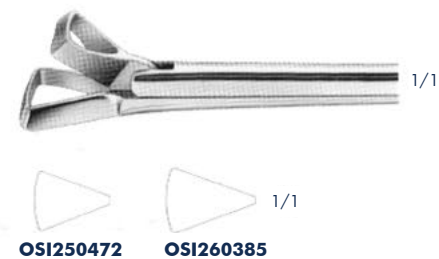

STRUYCKEN

OSI250458

Nasal cutting forceps, through cutting



Rhinology

OSI260386

Cup-shaped forceps, diameter of jaw 3 mm

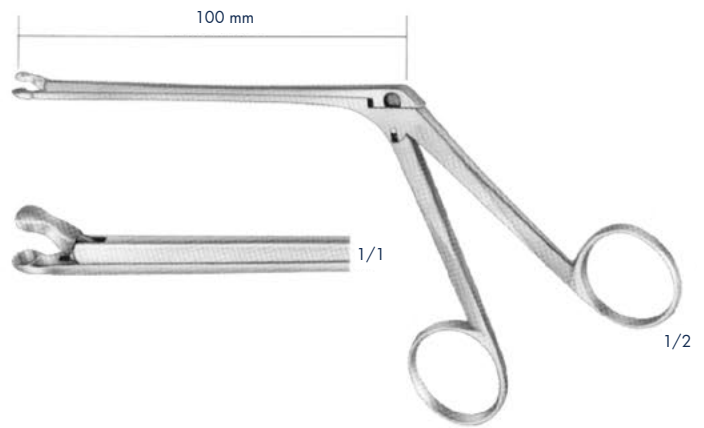

LUC

OSI250437
OSI250438

Septum forceps, with fenestrated jaws
200 mm

OSI250437

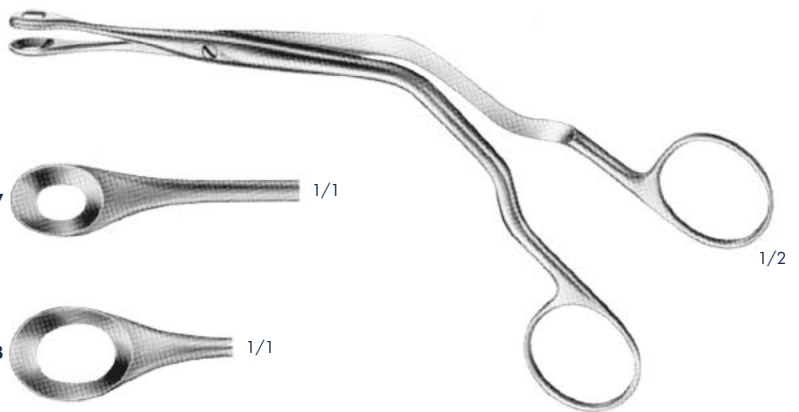

OSI250438

LUC

OSI260387 6,0 mm
OSI260388 7,5 mm
OSI260389 9,0 mm

Septum forceps, with fenestrated jaws
193 mm

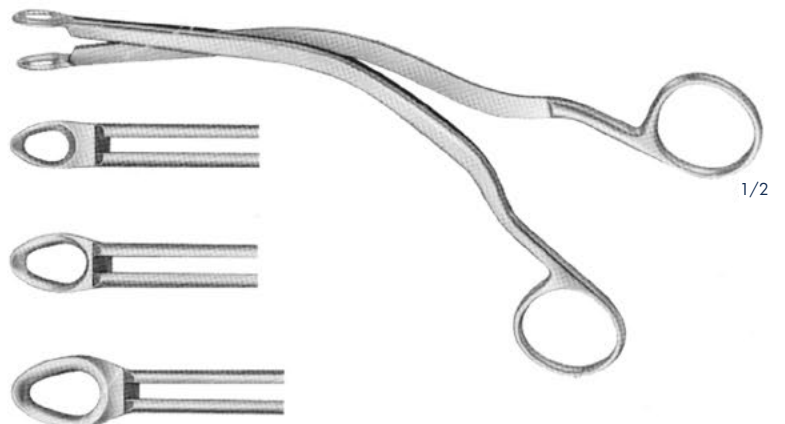

Rhinology

IRWIN MOORE

OSI260390

Septum forceps
190 mm



BRÜNINGS

OSI250439

OSI250440

OSI250441

OSI250442

Septum forceps
190 mm



Rhinology

OSI260391 4,2 mm
Ethmoidal forceps, straight

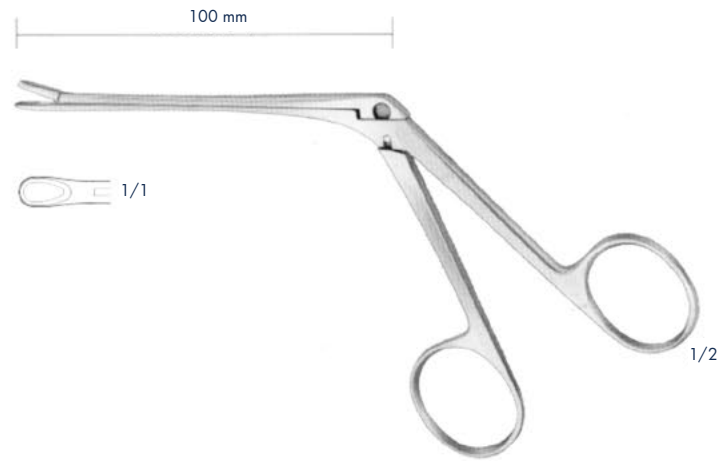

OSI260392 3 mm
Ethmoidal forceps, curved upward

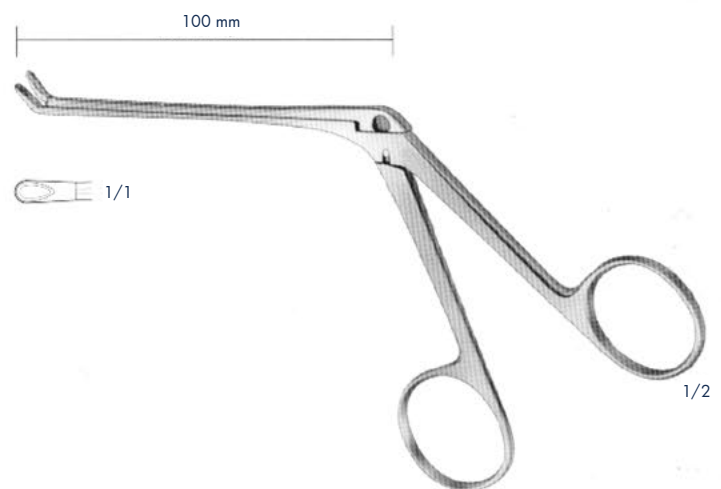

ST BARTS
OSI250830 3 mm
Rongeur, straight

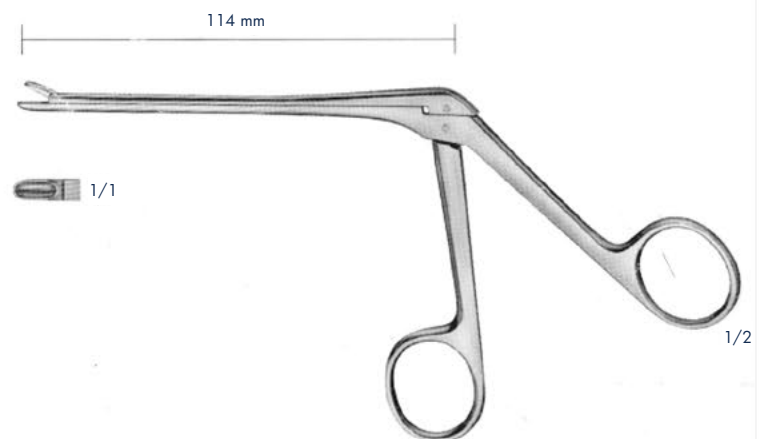

Rhinology



TAKAHASHI

OSI250444 3 mm
Ethmoidal forceps, upward curved, oval, cup-shaped

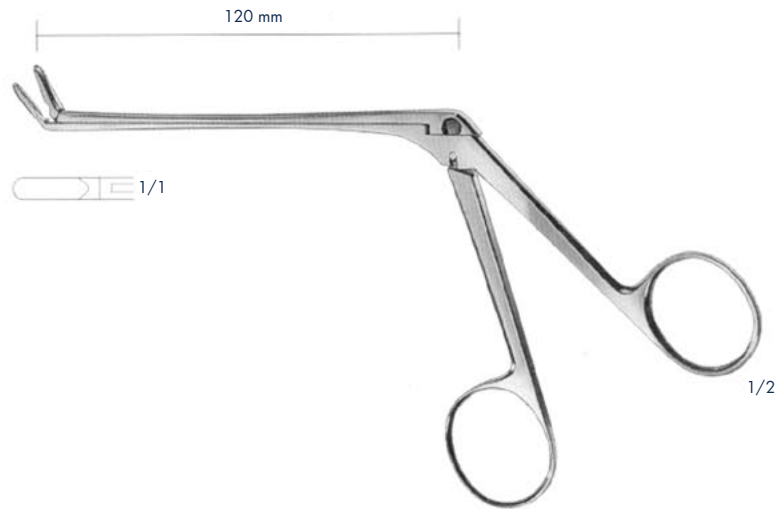

WATSON-WILLIAMS

OSI260393
OSI260394
OSI260395
Ethmoidal forceps



WATSON-WILLIAMS

OSI260396
Ethmoidal forceps for mucosa, serrated jaws



Rhinology

OSI260397

Septum speculum, right blade shortened,
for infundibulotomy
60 mm, 75 mm

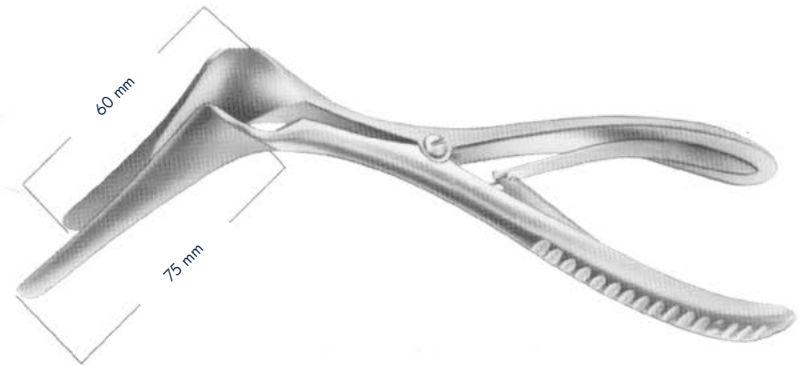

OSI260398

Septum speculum, left blade shortened,
for infundibulotomy
75 mm, 60 mm

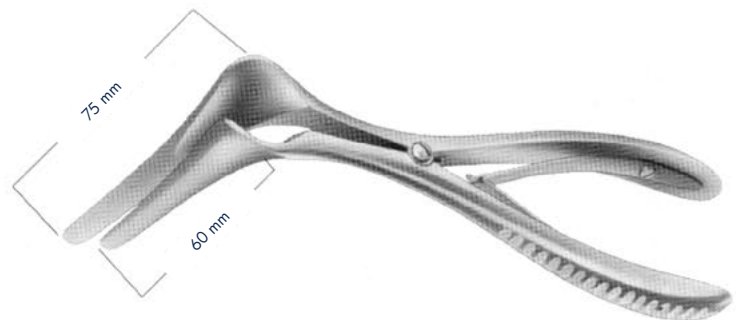

OSI100113

Razor blade breakers and holders,
straight
120 mm

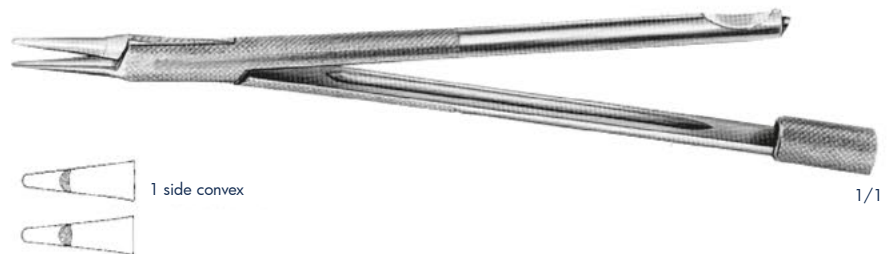

* To open push back the jacket

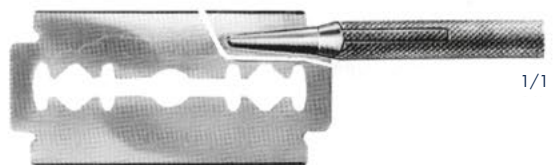

OSI100371

Razor blades
Sales unit : PZ = Package of 10 pieces

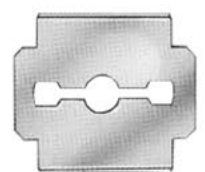

Rhinology

JOSEPH

OSI250505 straight
OSI250504 curved

Double-edged nasal knives, pointed
 145 mm

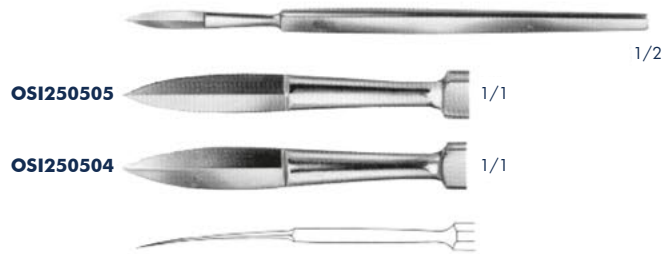

JOSEPH

OSI260399

Button-end knife, angled for, removal of cartilage
 175 mm



CONVERSE

OSI250509

Button-end knife, curved
 150 mm



JOSEPH

OSI250510

Button-end knife, straight
 140 mm



COTTLE

OSI250512

Septum knife
 150 mm



COTTLE

OSI250511

Septum knife, stiff blade with rounded edge
 140 mm

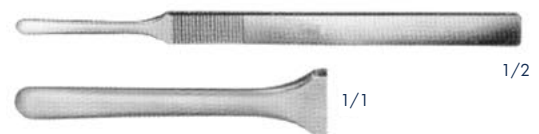

MOSING

OSI260400

Cartilage slitting knife, curved blade, pointed
 130 mm

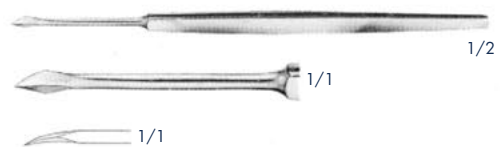

Rhinology

PENNINGTON

OSI250538

Raspatory

210 mm



COTTLE

OSI260401

Elevator, double-ended, graduated

200 mm



MOSING

OSI260402

Elevator, double-ended, graduated

200 mm



COTTLE

OSI250534

Elevator, double-ended, for tunneling

200 mm

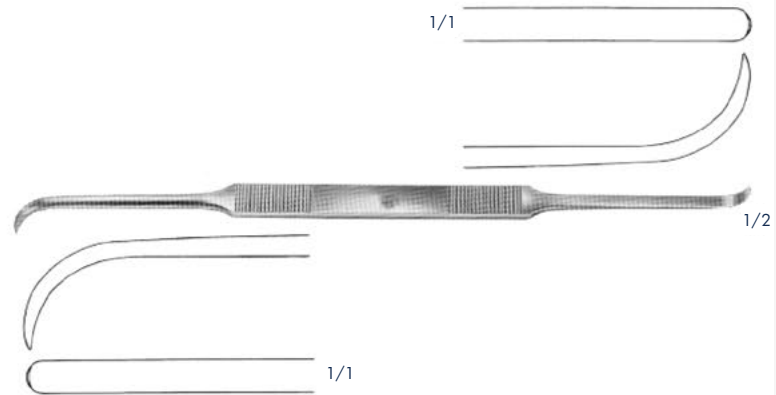

COTTLE

OSI260403 8 mm

Periosteal elevator, curved, sharp

195 mm

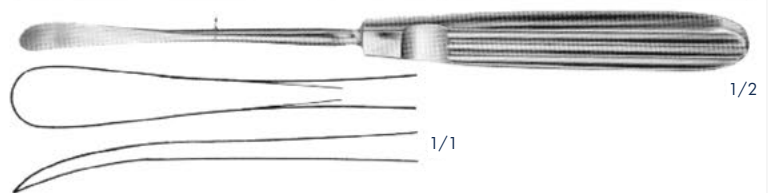

HALLE

OSI250527 3,3 mm

Elevator, blunt

180 mm

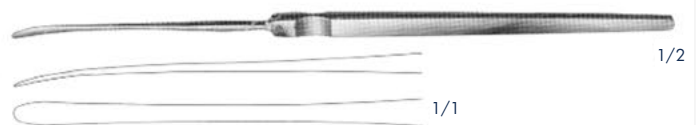

FREER

OSI250529 4 mm

Raspatory, sharp

190 mm



FREER

OSI250530 4 mm

Elevator, blunt

190 mm



Rhinoplasty

OSI160426 4 mm
OSI160427 5 mm
Suction raspatory, bayonet shaped, sharp
200 mm



LANDOLT
OSI160428 3,2 mm
Suction raspatory, bayonet shaped, sharp
200 mm



GORNEY
OSI160424 4 mm
Suction raspatory
180 mm

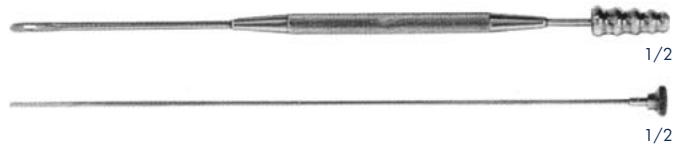

WEIR
OSI160425
Suction dissector, semi-sharp
190 mm



AUFRICHT
OSI250618
Retractor speculum - nasal retractor
160 mm

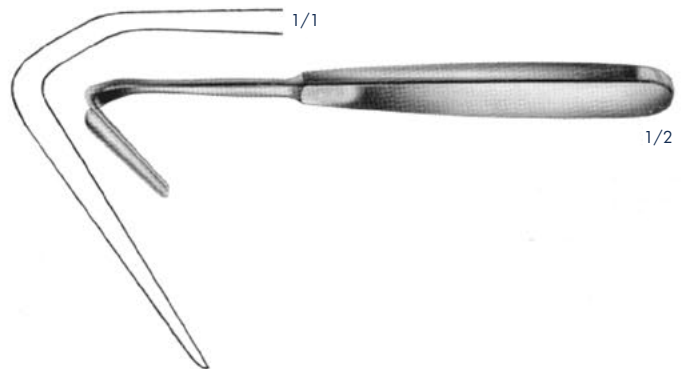

CRAIG AUFRICHT
OSI260757
Nasal retractor, fibre optic, universal fitting \varnothing 3 mm
175 mm

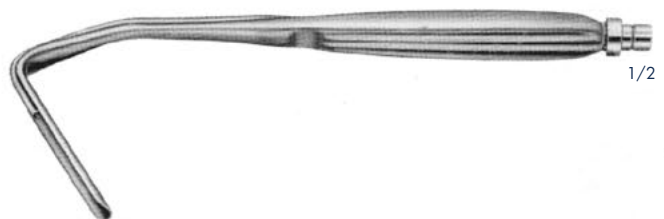

Rhinoplasty

WALTER

OSI260404

Double-ended retractor, one end 2 blunt prongs and one with blade



MOSING

OSI260405

Alar retractor

140 mm



COTTLE

OSI260406

Alar retractor

140 mm



OSI220113

Double ended retractor

130 mm

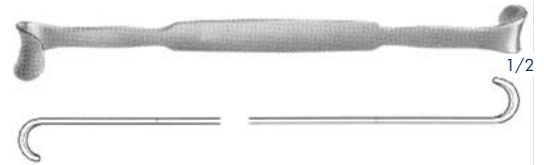

COTTLE

OSI250612

Tenaculum, 120° retrograde curved

160 mm



COTTLE

OSI260407

Tenaculum, 180° retrograde curved

160 mm



CUSHING

OSI210163

Buttoned hook

190 mm



GRAEFE

OSI260408

Skin hook, sharp

125 mm



Rhinoplasty

FOMON

OSI260409

Alar retractor, 2 prongs, blunt/blunt
145 mm

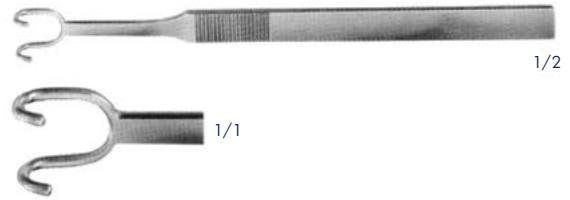

COTTLE

OSI250629

Alar retractor, sharp prong on right when
instrument lies with prongs up
145 mm

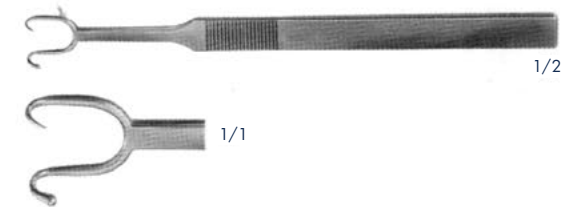

COTTLE

OSI250630

Alar retractor, sharp prong on left when
instrument lies with prongs up
145 mm

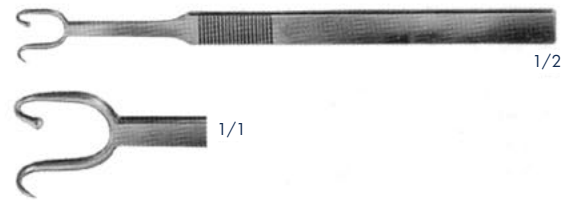

KILNER

OSI250619

Alar retractor, 2 sharp prongs
80 mm

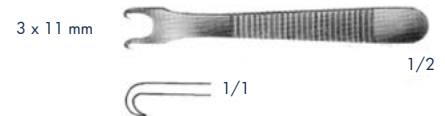

CONVERSE

OSI250620

Alar retractor, double-ended 2 blunt prongs
120 mm

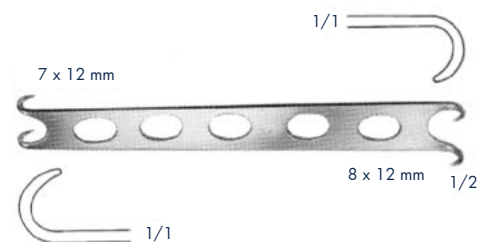

COTTLE

OSI250627

Alar retractor, with saw and knife guide, blunt
200 mm

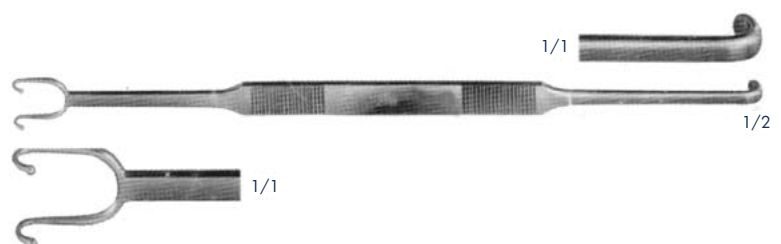

Rhinoplasty

COTTLE

OSI260410 8 mm
Fishtail osteotomes with protected ends,
double guarded
180 mm

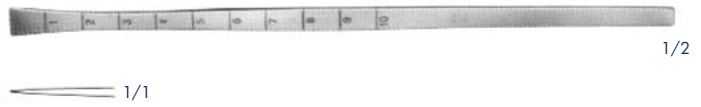

COTTLE

OSI180242 4 mm
OSI180243 6 mm
OSI180244 8 mm
OSI180245 10 mm
OSI180246 12 mm
Osteotomes with depth markings
180 mm



COTTLE

OSI250551 4 mm
OSI250552 7 mm
OSI250553 9 mm
OSI250554 12 mm
Chisel with depth markings
180 mm

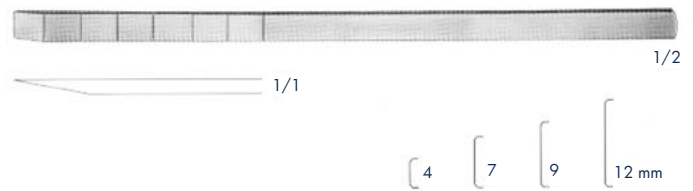

COTTLE

OSI250555 6 mm
Osteotome, curved, for transverse
osteotomies
180 mm



WALTER

OSI250566 3,0 mm
OSI250567 4,5 mm
Chisel with notch, double guarded
180 mm

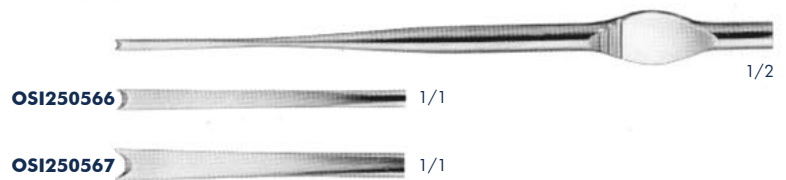

MOSING

OSI260411 curved left
OSI260412 curved right
OSI260413 straight
Osteotome, single guarded
175 mm

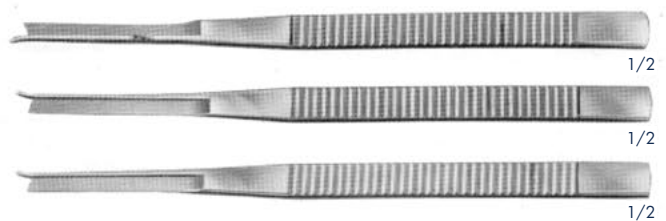

Rhinoplasty

OSI260414 4 mm
OSI260415 6 mm
OSI260416 8 mm
 Osteotomes for septum
 185 mm

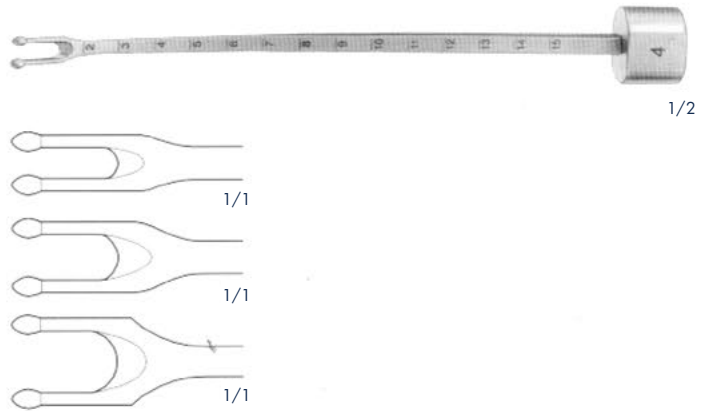

CINELLI
OSI250577 10 mm
OSI250578 12 mm
OSI250579 14 mm
OSI250580 16 mm
 Osteotome, double guarded, straight
 160 mm

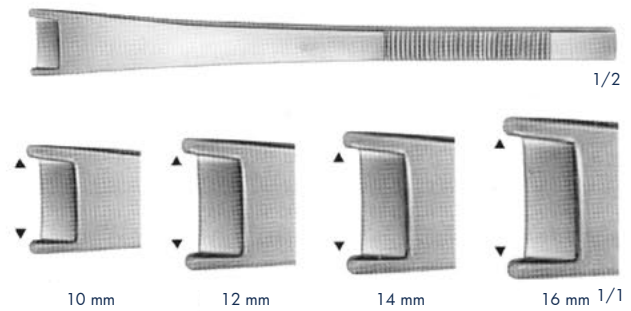

LAMBOTTE
OSI190199 4 mm
OSI190200 6 mm
OSI190201 8 mm
OSI190202 10 mm
OSI190203 12 mm
OSI190204 15 mm
 Osteotome
 125 mm

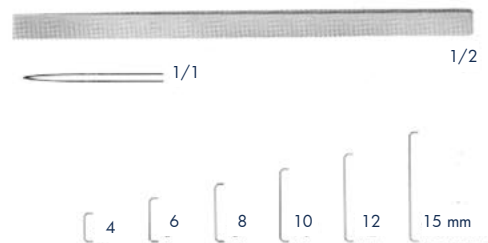

FOMON
OSI250574 5 mm
OSI250576 8 mm
 Osteotome, single guarded
 170 mm



GILLIES
OSI180235 5 mm
OSI180236 7 mm
OSI180237 9 mm
 Osteotome
 140 mm



Rhinoplasty

COTTLE

OSI180192

Mallet, 235 g 1 plain side,
1 convex side
185 mm

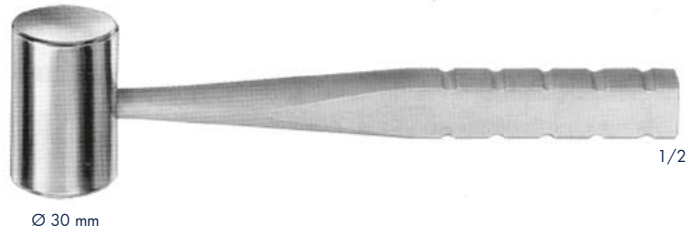

FOMON

OSI260417

File, fine/coarse
215 mm

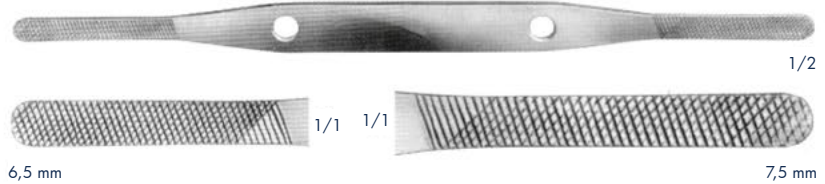

FOMON

OSI190744

Rasp, fine coarse teeth
215 mm

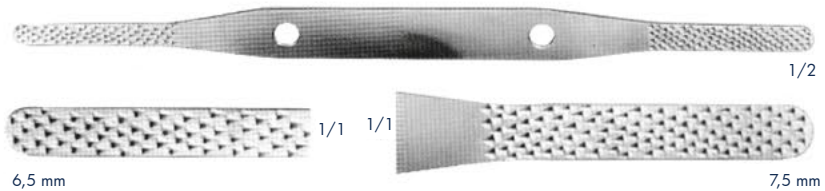

JOSEPH

OSI250594 fine chequered

OSI190741 coarse chequered

Rasps, for filing nasal bones
165 mm

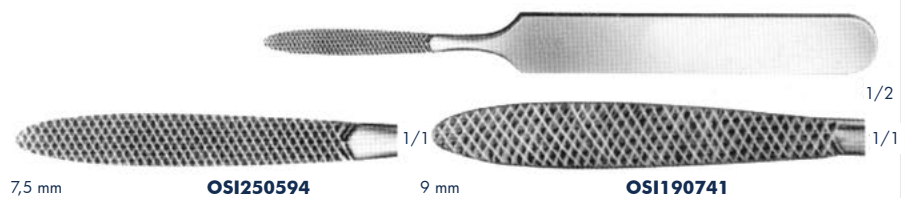

MALTZ

OSI250593

Rasp, teeth set to cut on down stroke
180 mm

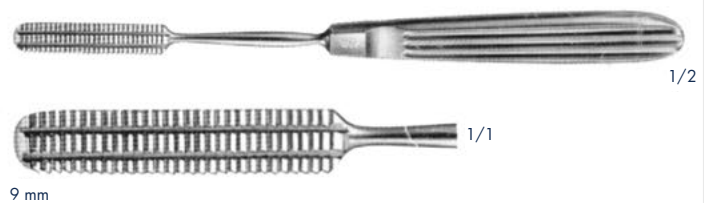

MALTZ

OSI190742 straight

OSI190743 curved

Rasp
180 mm



Rhinoplasty

GALLAHER

OSI250595 6,5 mm

Rasp, coarse

190 mm

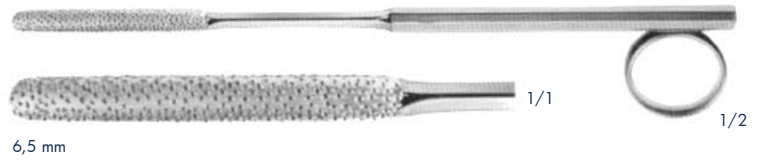

JOSEPH

OSI250590

Nasal saw, straight



OSI250591

Nasal saw, bayonet shaped, curved to the right



OSI250592

Nasal saw, bayonet shaped, curved to the left

170 mm



BULL

OSI260418 right

OSI260419 left

Nasal saw, bayonet shaped, with button end

190 mm



OSI260420

Bone crusher, for preparation of cartilage implant material, complete with clamp

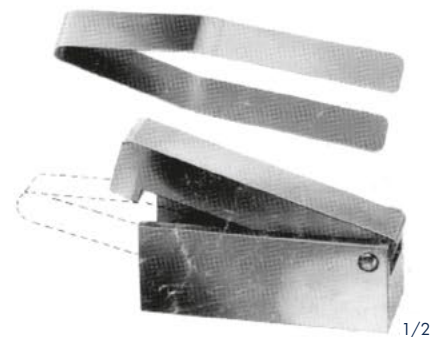

Rhinoplasty

ASH

OSI250649

Septum straightening forceps
220 mm



WALSHAM

OSI250647

Septum straightening forceps, right

OSI250648

Septum straightening forceps, left
210 mm

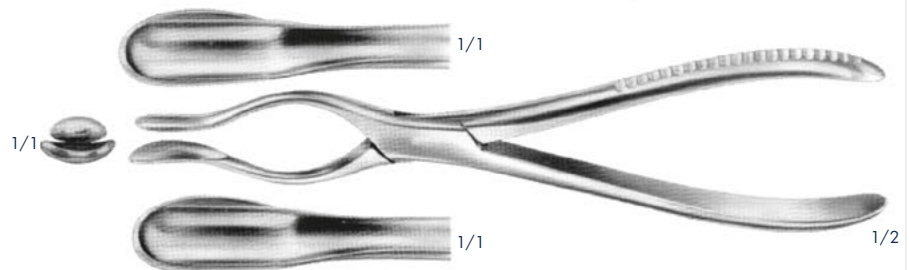

COTTLE-WALSHAM

OSI250646

Septum straightening forceps, with aseptic lock
220 mm

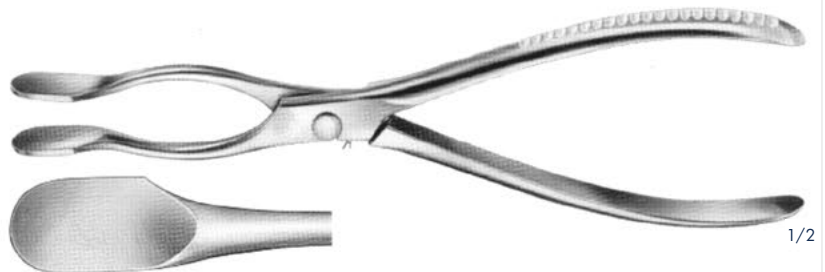

OSI260421

Cartilage morselizer forceps with removeable guard, converts cartilage into a membranous-like structure, which permits repositioning of the septum to midline
200 mm

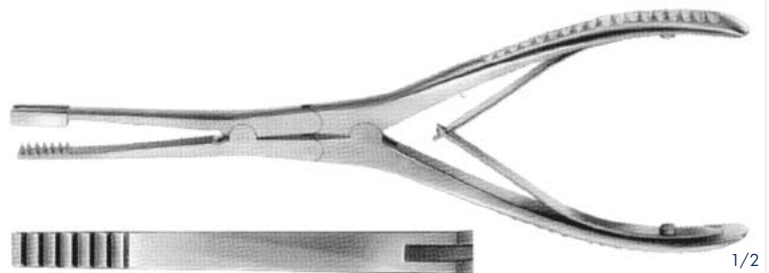

BOIES

OSI260422

Nasal fracture elevator, a strong instrument with blunt edges for elevating nasal fractures oval
180 mm



GOLDMANN

OSI260423

Septum elevator, round (displacer)
200 mm



Rhinoplasty

KAZANJIAN

OSI190589

Bone cutting forceps, for removal of nasal hump

185 mm

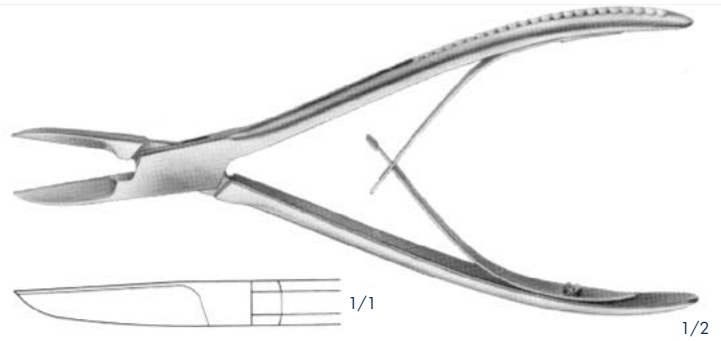

OSI260424

Bone cutting forceps, with double Action

170 mm

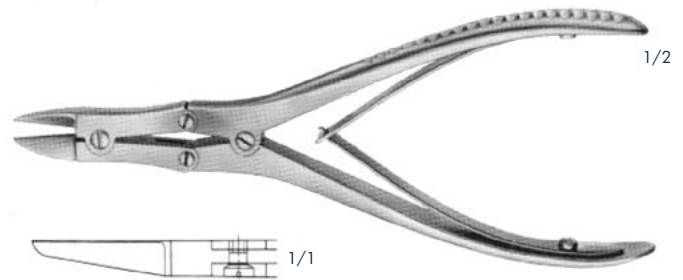

JANSEN-MIDDLETON

OSI250474

Septum forceps, through cutting

210 mm

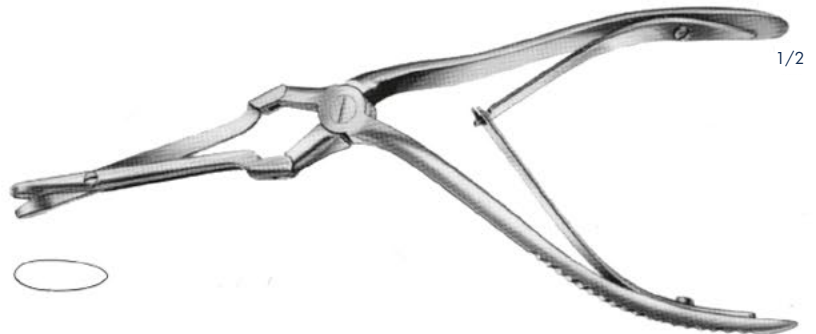

OSI260425

Plugger, double ended, for insertion of dressings

170 mm

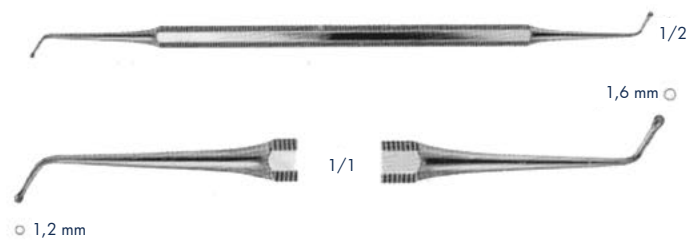

OSI180216 Ø 3 mm

OSI180217 Ø 5 mm

Haemostatic tamper

160 mm



Rhinoplasty

KILNER

OSI110275 125 mm

OSI110276 150 mm

Dissecting scissors, with flat tips, curved, blunt/blunt

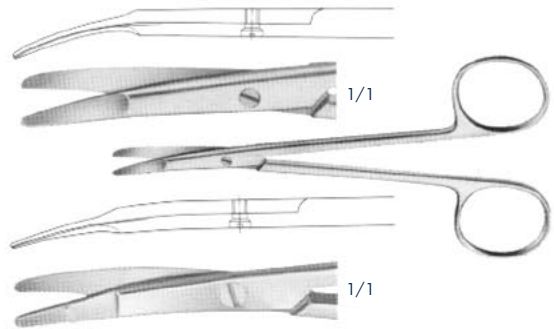

KILNER

OSI110562

Scissors, straight, sharp/sharp

115 mm

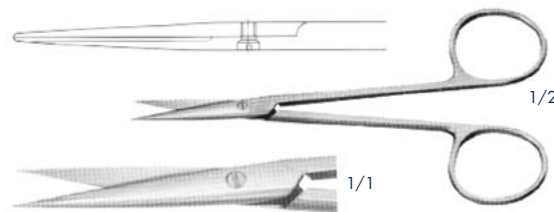

JEMASON-WERBER

OSI260426

Dissecting scissors, very delicate, curved, blunt/blunt

130 mm

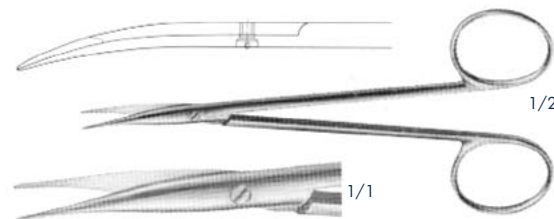

JEMASON

OSI110599

Dissecting scissors, delicate, curved, blunt/blunt

150 mm

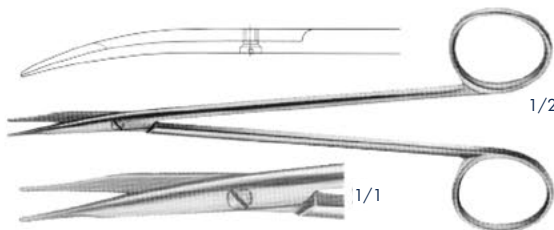

REYNOLDS

OSI110600 145 mm

OSI110601 175 mm

Dissecting scissors, with flat tips, curved, blunt/blunt

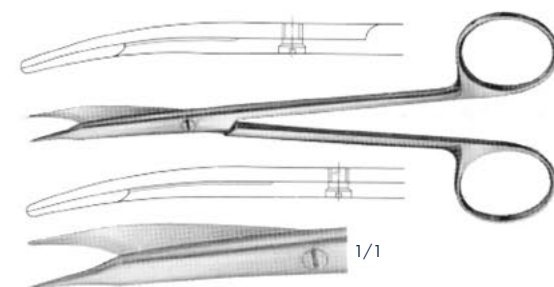

Sinus and Hypophysectomy

TILLEY LICHTWITZ

OSI260427 Ø 1,7 mm

OSI260428 Ø 2,0 mm

Antrum trocar

200 mm



TILLEY LICHTWITZ

OSI260429 Ø 2,3 mm

OSI260430 Ø 2,7 mm

Antrum trocar

185 mm



PIERCE

OSI160452 Ø 4 mm

Antrum trocar

160 mm

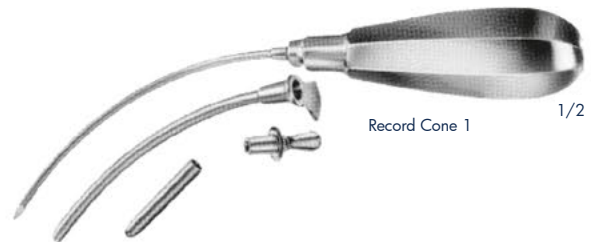

PIERCE

OSI160455 Ø 4 mm

Harpoon trocar

170 mm

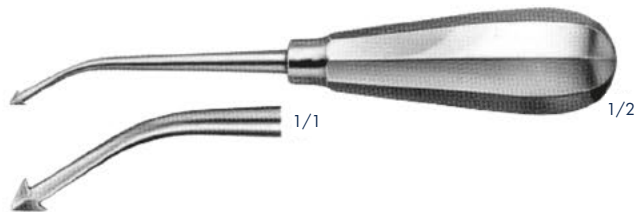

KRAUSE

OSI160453 Ø 4 mm

Antrum trocar with irrigation

160 mm

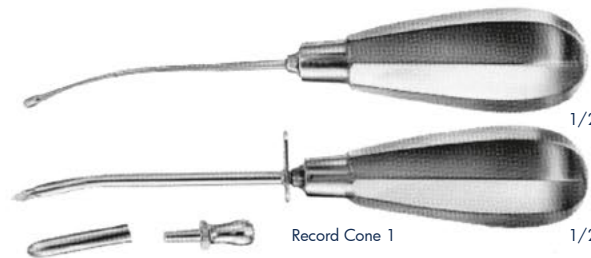

COAKLEY

OSI160454 Ø 3 mm

Antrum trocar with irrigation

140 mm

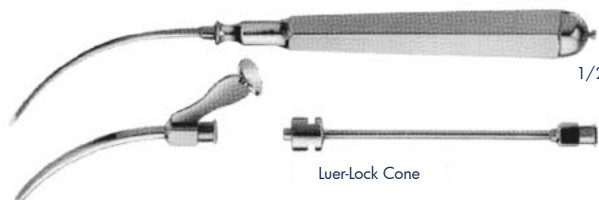

EICKEN

OSI260431 Ø 2,5 mm

OSI260432 Ø 3,0 mm

Irrigating antrum cannula with central opening, blunt, Luer attachment

130 mm



Sinus and Hypophysectomy

SIEBENMANN

OSI250696 Ø 2,5 mm
Irrigating antrum cannula with outside opening, blunt
130 mm



SIEBENMANN

OSI250701 Ø 2,5 mm
Irrigating antrum cannula with inside opening, blunt
130 mm



ROSE

OSI260433
Antrum irrigating cannula, malleable, luer attachment
102 mm



OSI260434

Cone, only



LICHTWITZ-BIER

OSI260435 Ø 1,5 mm
OSI260436 Ø 1,8 mm
OSI260437 Ø 2,0 mm
Antrum trocar needles, Luer attachment
100 mm

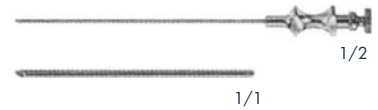

EICKEN

OSI260438 Ø 1,5 mm
OSI260439 Ø 1,8 mm
OSI260440 Ø 2,0 mm
OSI260441 Ø 2,5 mm
Antrum trocar needles, Luer attachment
100 mm

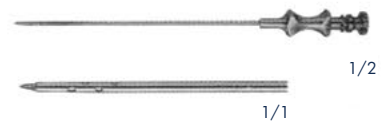

OSI260442

Antrum applicator
75 mm



OSI250603 sharp
OSI250604 blunt
Antrum rasp, American pattern
180 mm

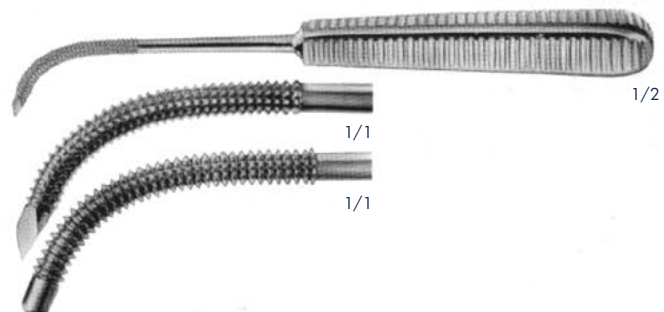

Sinus and Hypophysectomy

FAULKNER

OSI260443

Antrum trocar chisel, cutting on the push as well as on the pull
150 mm

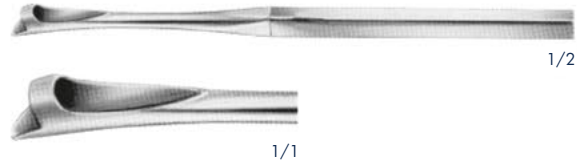

WAGENER

OSI260444 3 mm forward cutting

OSI260445 3 mm backward cutting

Punches for enlarging intranasal opening into the maxillary antrum, For use with handles

OSI260444 



OSI260445 



OSTROM

OSI260446 2 mm

OSI260447 4 mm

Punches for enlarging intranasal opening into the maxillary antrum. For use with handles **OSI260177**
OSI230499 and **OSI260176** backward cutting

OSI260446 



OSI260447 



Sinus and Hypophysectomy

BRÜNNINGS

OSI260177

Universal handle
150 mm

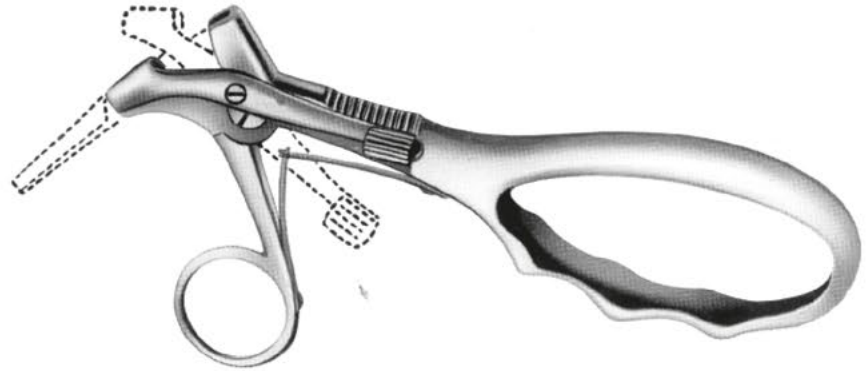

OSI230499

Universal handle
140 mm



HUBER

OSI260176

Universal handle
140 mm



Sinus and Hypophysectomy

SEWALL

OSI190674

Antrum elevator (curette) blunt
200 mm

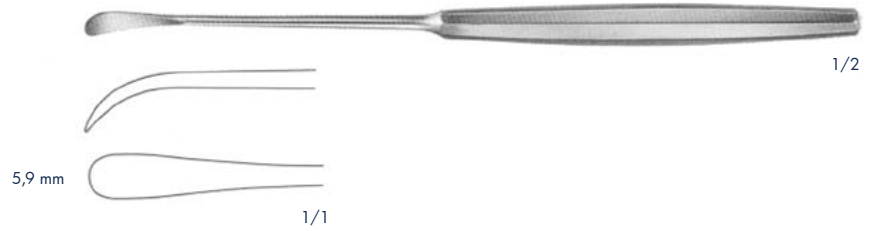

COAKLEY

OSI250655

OSI250656

OSI250657

OSI250658

OSI250659

OSI250660

Antrum curettes, rigid shank
170 mm

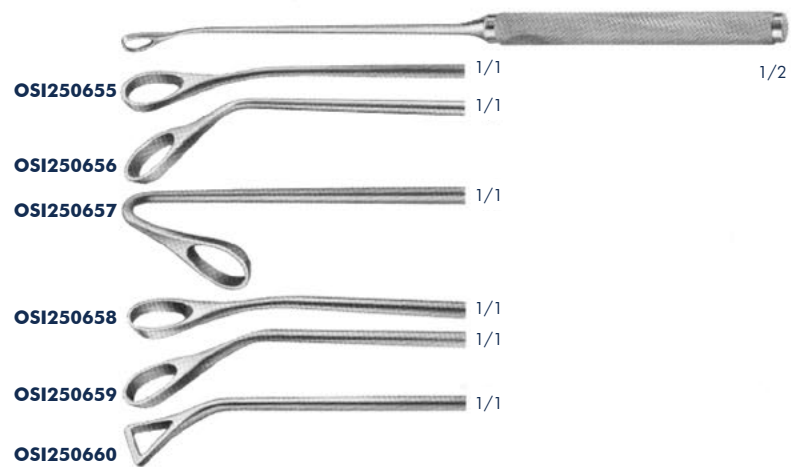

MACKIE

OSI260450 6 mm

Antrum curette
197 mm



UFFENORDE

OSI190772

Antrum curette, right handed
170 mm

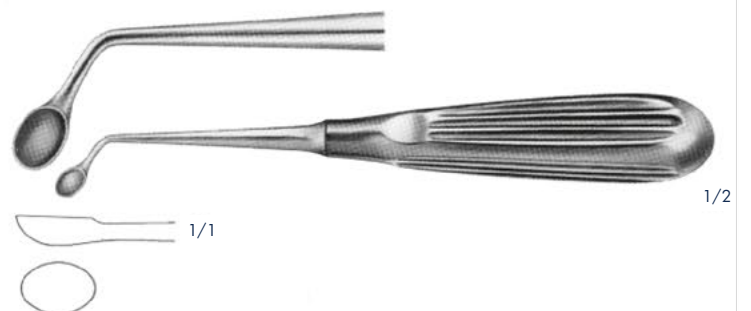

Sinus and Hypophysectomy

HAJEK-CLAUS

OSI260451 5 mm
Antrum punch through cutting
200 mm

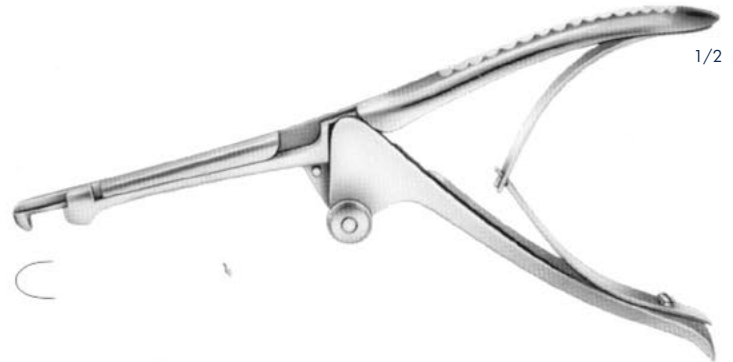

KERRISON

OSI250501 4 mm
Punch

OSI250501

1/1

KERRISON

OSI250502 5 mm
Punch

OSI250502

1/1

80 mm



1/2

OSTROM

OSI260452
Antrum punch reverse Action jaw

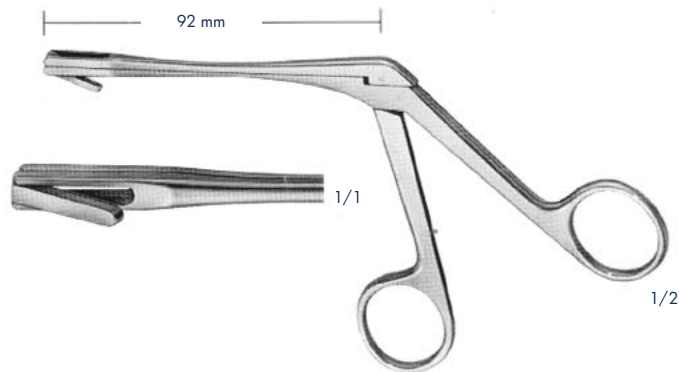

Sinus and Hypophysectomy

TALBOT

OSI150741

Orbita-retractor, right
165 mm

OSI150741

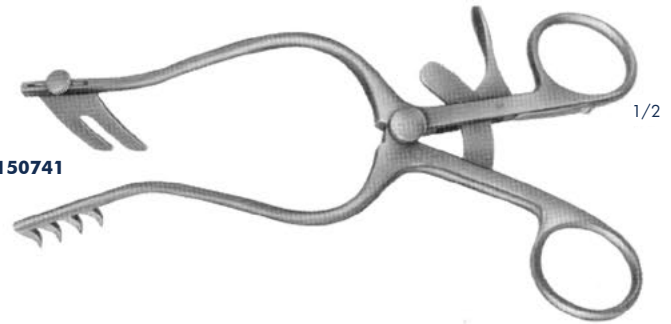

TALBOT

OSI150742

Orbita-retractor, left
165 mm

OSI150742

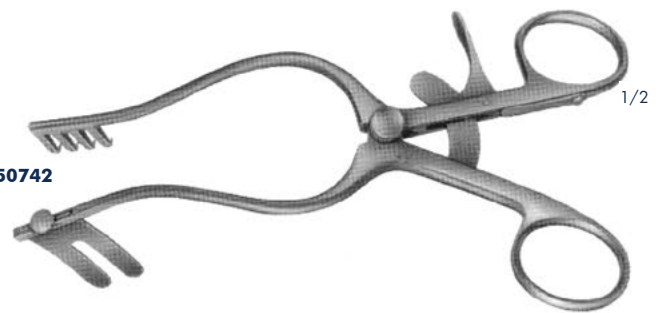

HALLE

OSI190389 4,2 x 6,2 mm

OSI190390 5,2 x 7,3 mm

OSI190391 6,8 x 9,6 mm

Antrum currettes, malleable, sharp
215 mm



4,2 x 6,2 mm

5,2 x 7,3 mm

6,8 x 9,6 mm



Fig. 00
OSI190389



Fig. 0
OSI190390



Fig. 1
OSI190391

HAJEK

OSI260453 3,5 mm

Irrigating cannula (frontal sinus)
made of silver, LUER

165 mm



RITTER

OSI260454 Ø 2,5 mm

OSI260455 Ø 3,0 mm

OSI260456 Ø 4,0 mm

OSI260457 Ø 5,0 mm

Frontal sinus bougies

160 mm



Sinus and Hypophysectomy

SEIFFERT

OSI160239 Ø 1 mm

Salival probe, silver

180 mm



MACKAY

OSI260458

Antrum curette

290 mm



5 mm x 2,5 mm

MACKAY

OSI260459

Antrum curette, straight

210 mm



5 mm x 2,5 mm



MACKAY

OSI260460

Antrum sickle knife, straight

210 mm



Sinus and Hypophysectomy

MACKAY

OSI260461

Modified Stamberger punch
backward cutting

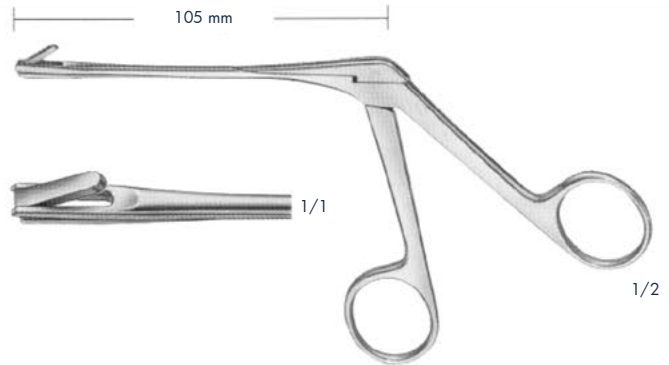

MACKAY "CHOMPER"

OSI250833 5,5 mm

Rongeur

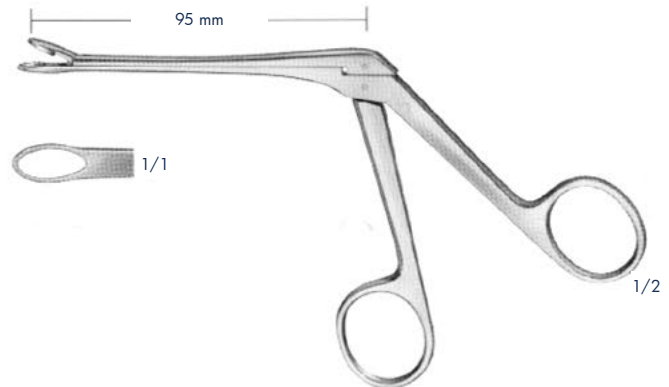

MACKAY MODIFIED WEIL-BLACKESLEY

OSI260784 3,5 mm

Rongeur with suction tube
120 mm



MACKAY MODIFIED WEIL-BLACKESLEY

OSI250829 3,5 mm

Rongeur with suction tube
110 mm

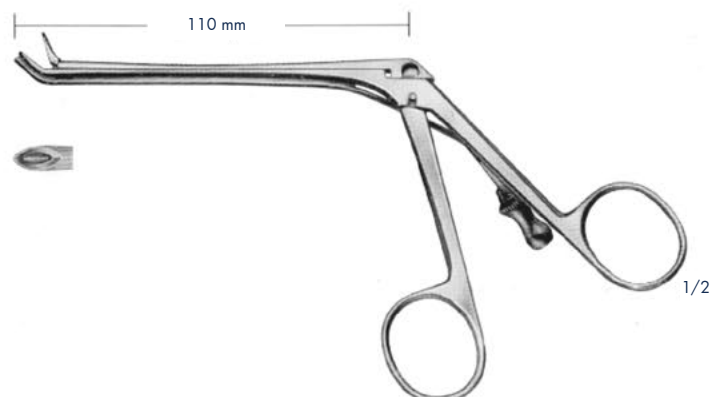

Sinus and Hypophysectomy

MACKAY

OSI260462 10 mm
Scissors, straight

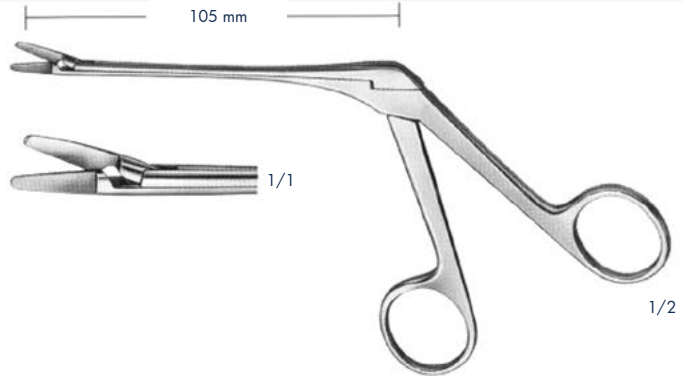

MACKAY

OSI260463 10 mm
Scissors, angled right

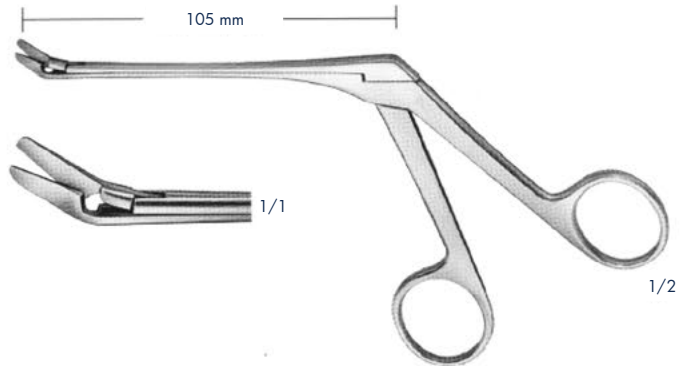

WEIL-BLAKESLEY

OSI250448 3,0 mm
OSI250449 3,6 mm
OSI250450 4,2 mm
OSI250451 4,8 mm
OSI250452 5,8 mm
Ethmoidal forceps, straight, oval, pointed, cup-shaped fenestrated jaws

OSI250448 1/1

OSI250449 1/1

OSI250450 1/1

OSI250451 1/1

OSI250452 1/1

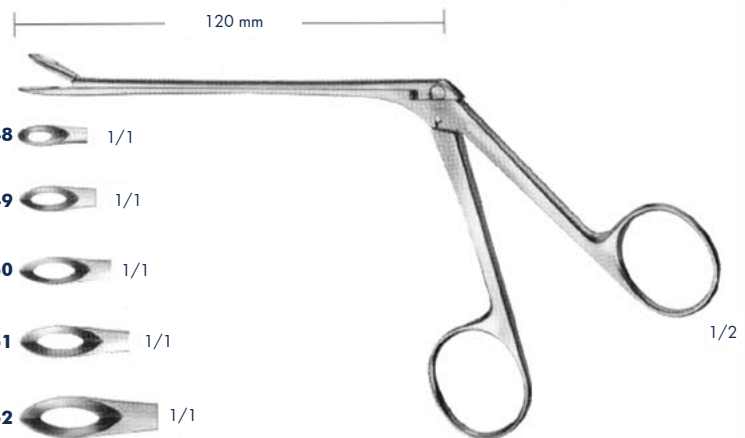

WEIL-BLAKESLEY

OSI250454 3,6 mm
OSI250455 4,2 mm
OSI250456 4,8 mm
Ethmoidal forceps, upwards curved, oval, pointed, cup-shaped, fenestrated jaws

OSI250454 1/1

OSI250455 1/1

OSI250456 1/1

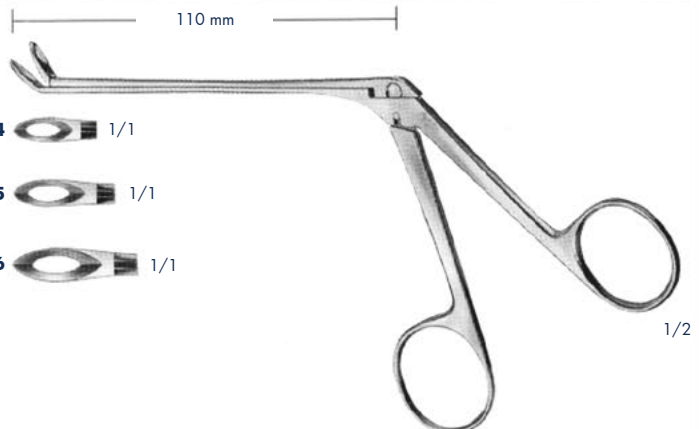

Sinus and Hypophysectomy

CUSHING-LANDOLT

OSI260464 70 x 15 mm

OSI260465 90 x 15 mm

OSI260466 110 x 15 mm

Specula for transsphenoidale hypophysectomy



1/2



LANDOLT

OSI260467

Spreader, for spreading of specula



1/2

LANDOLT

OSI260468 Ø 6 mm

OSI260469 Ø 10 mm

Hypophysectomy mirror 45° angled, for use with
170 mm



1/2

LANDOLT

OSI260470 Ø 10 mm

Hypophysectomy mirror 75° angled
170 mm



1/2

OSI260471

220 mm



1/2

Sinus and Hypophysectomy

COTTLE

OSI260472 76 x 7 mm

Selfretaining septum speculum suitable as introducer for

OSI260473 90 x 7 mm

Selfretaining septum speculum suitable as introducer for

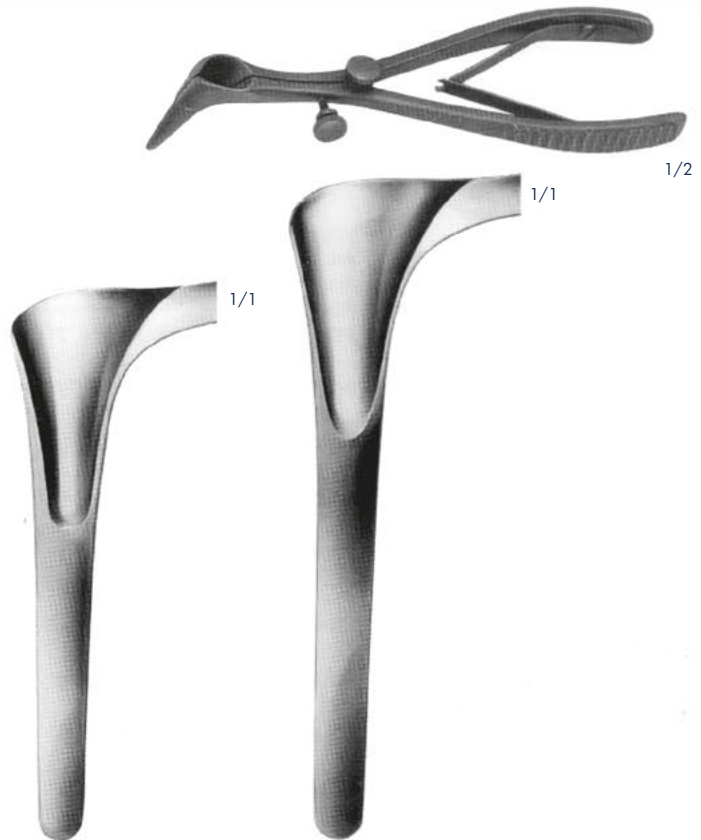

PAPAVERO-CASPAR

OSI260474 80 x 11 mm

OSI260475 90 x 13 mm

OSI260476 100 x 15 mm

Slim profile and lightweight specula for transsphenoidal surgery with key



PAPAVERO-HARTMANN

OSI260477

Spreader for specula



PAPAVERO

OSI260478 4 mm

Bayonet chisel for the perpendicular plate of ethmoid bone

220 mm



Sinus and Hypophysectomy

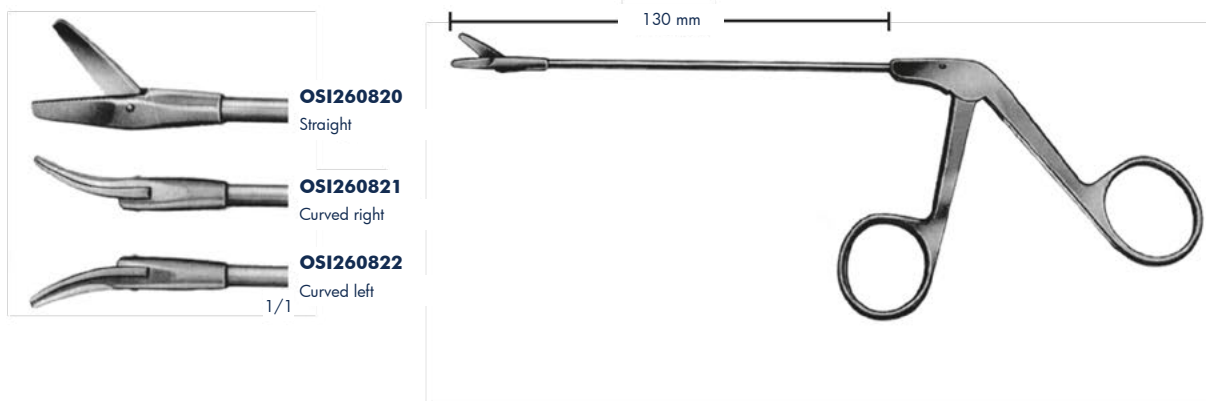
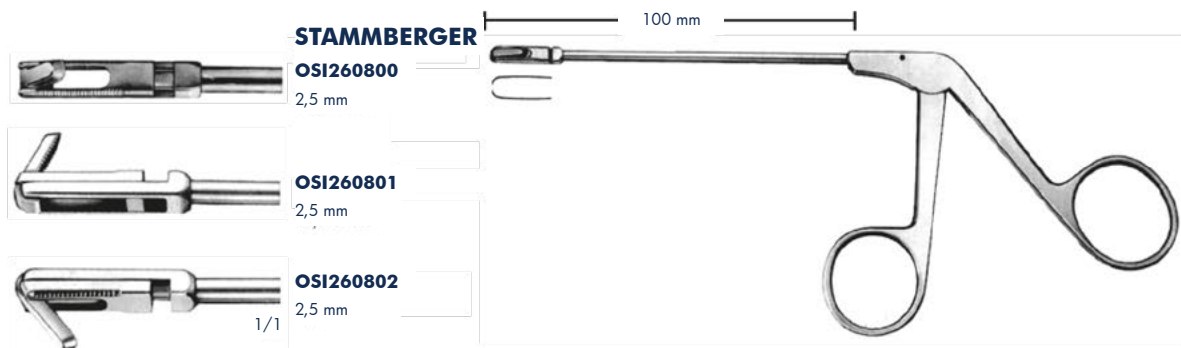

LANDOLT

OSI260479

90° angled/90°

OSI260480

120° angled/90°

Bipolar coagulation forceps for hypophysectomy

LANDOLT

OSI260481 90°

OSI260482 120°

Spare inner part, silicone insulated, for above coagulation forceps

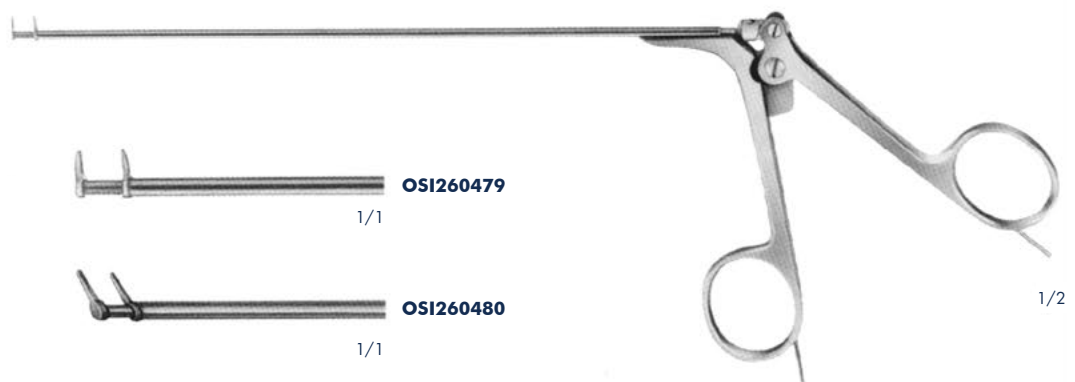

Sinus and Hypophysectomy

FAHLBUSCH

OSI260483

Micro scissors with tubular shaft, extra delicate pattern, horizontal cutting, curved on flat

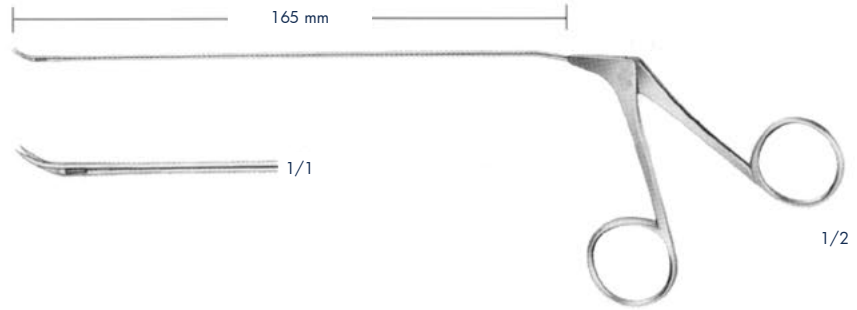

NICOLA

OSI260484 Ø 2,5 mm

Forceps, scoop-shaped



YASARGIL-NICOLA

OSI260485

Forceps, with delicate jaws



NICOLA

OSI260486

Scissors, straight



LANDOLT

OSI120438

Forceps, angular

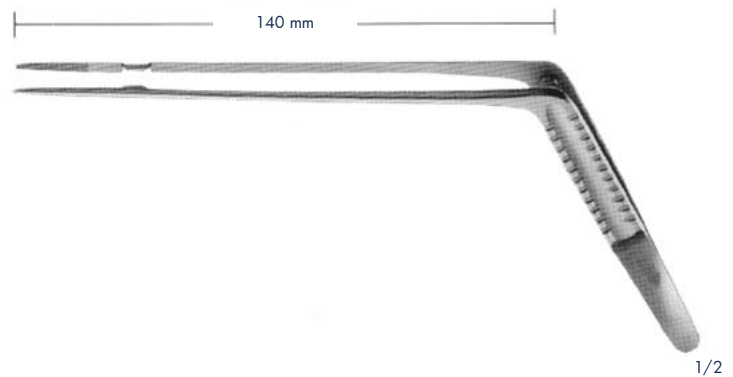

Sinus and Hypophysectomy

RAY

OSI260487 Ø 4 mm
Pituitary curette, horizontal 45°
190 mm



RAY

OSI260488 Ø 4 mm
Pituitary curette, vertical 45°
190 mm



NICOLA

OSI260489 Ø 6,5 mm
Pituitary curettes, malleable, curved to right

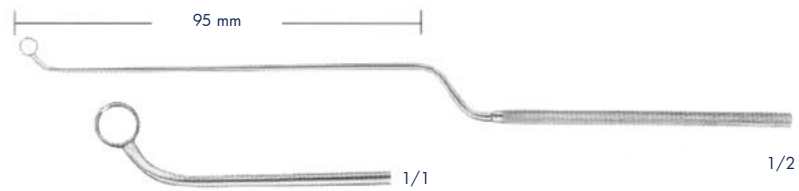

OSI260450 Ø 6,5 mm
Pituitary curettes, malleable, curved to left
215 mm

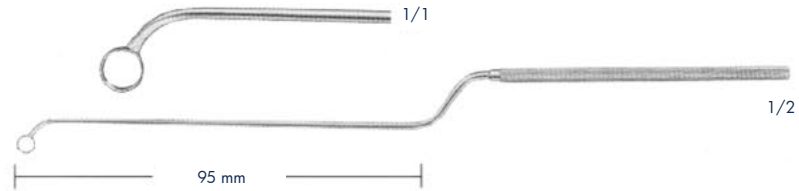

NICOLA

OSI260491 Ø 6,5 mm
Pituitary curette, malleable
215 mm

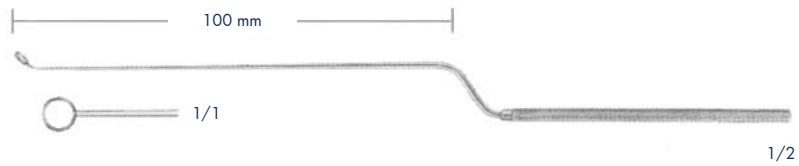

NICOLA

OSI260492
Pituitary raspatory
215 mm



NICOLA

OSI260493 Ø 4 mm
OSI260494 Ø 6 mm
Pituitary curette, malleable
260 mm

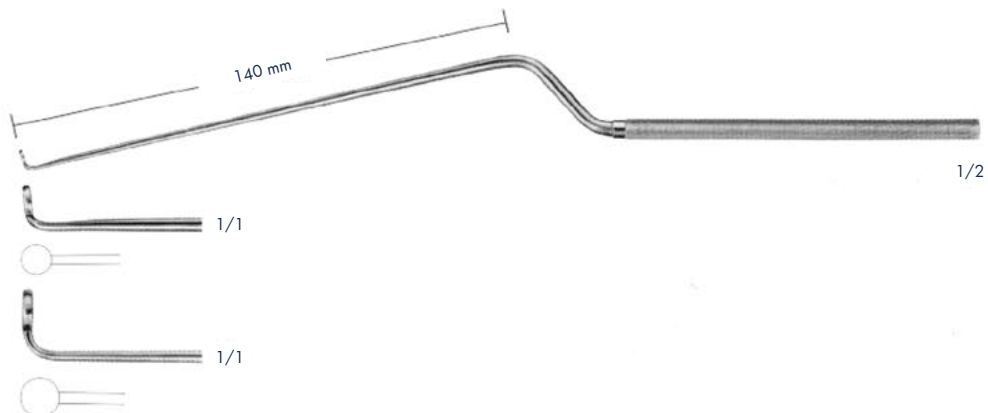

Sinus and Hypophysectomy

HARDY

OSI260495 curved to left

OSI260496 curved to right

Pituitary enucleator, bayonet-shaped,
blunt curved to right
215 mm

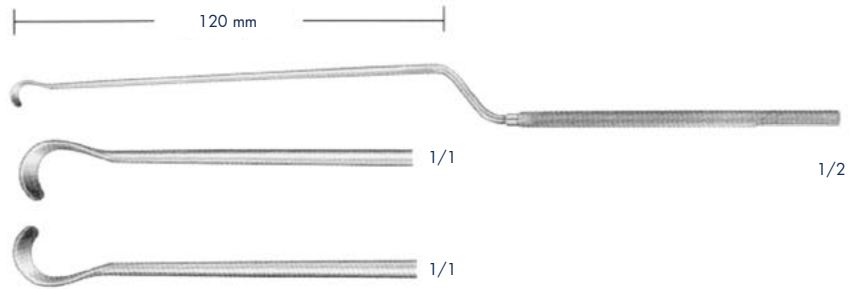

HARDY

OSI260497 curved to left

OSI260498 curved to right

Dissector, sharpened inner
edge, bayonet-shaped
215 mm

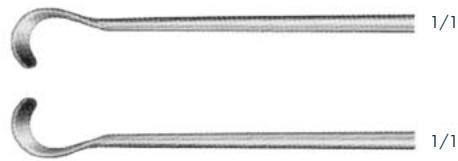

HARDY

OSI260499

Pituitary implant fork,
bayonet-shaped
215 mm



HARDY-FAHLBUSCH

OSI260500 curved to left

OSI260501 curved to right

Dissector, sharpened inner edge
245 mm

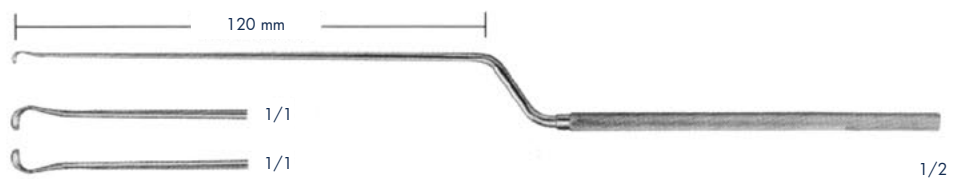

Sinus and Hypophysectomy

LANDOLT

OSI260502 curved to left

OSI260503 curved to right

Pituitary enucleator,
bayonet-shaped, blunt
malleable
260 mm

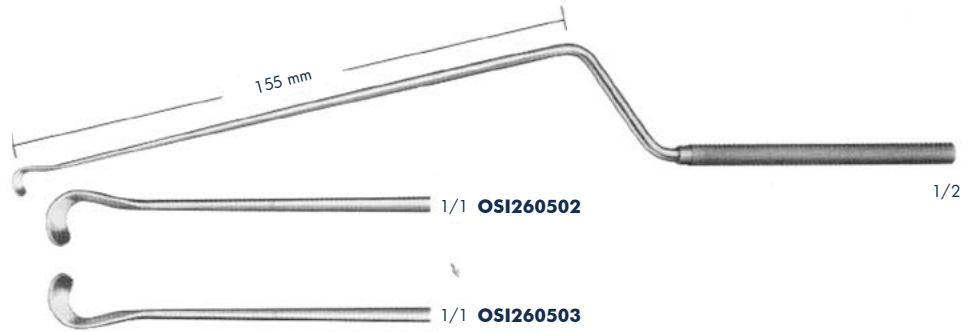

LANDOLT

OSI260504

Pituitary curette,
bayonet-shaped, malleable
260 mm



LANDOLT

OSI260505

Blunt hook, bayonet-
shaped, malleable
260 mm



HARDY

OSI260506

OSI260507

OSI260508

OSI260509

OSI260510

OSI260511

Hypophysectomy enucleators,
for the left side of the
hypophysis, as **OSI260503**
245 mm

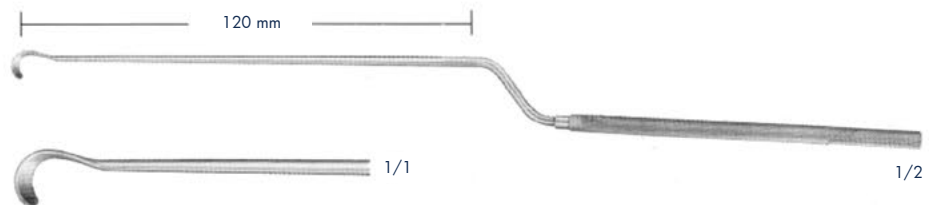

Sinus and Hypophysectomy

FAHLBUSCH

OSI260512

Scoop, malleable
260 mm

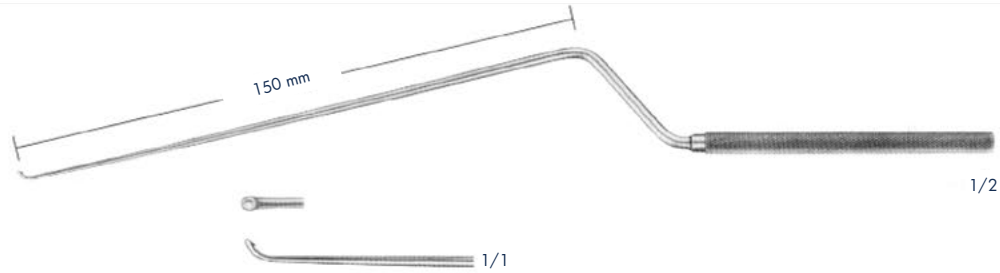

FAHLBUSCH

OSI260513 Ø 2,5 mm

Curette, malleable
260 mm



LANDOLT-REULEN

OSI260514 Ø 2,2 mm

OSI260515 Ø 3,2 mm

Raspatories, rigid
260 mm

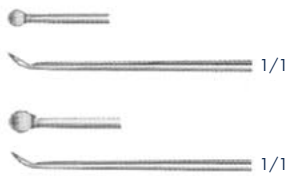

LANDOLT-REULEN

OSI260516 Ø 2,5 mm

Curette, rigid
260 mm



LANDOLT-REULEN

OSI260517 Ø 1,7 mm

Blunt hook, rigid
260 mm



LANDOLT-REULEN

OSI260518 Ø 2 mm

Dissector, rigid
260 mm



Sinus and Hypophysectomy

OSI260519

Micro dissector, upward curved
230 mm



OSI260520

Micro raspatory, upward curved
230 mm



LANDOLT

OSI100340

Scalpel handle, bayonet-shaped,
square shank
210 mm

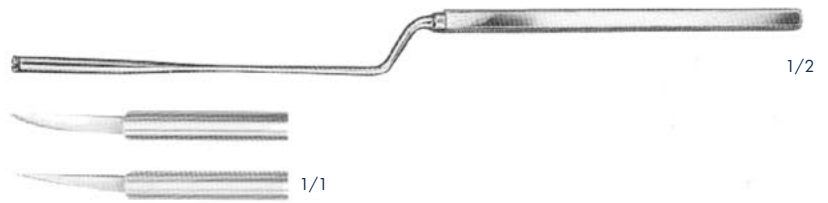

LANDOLT

OSI100338

Scalpel handle, bayonet-shaped,
round
250 mm



OSI100331

Scalpel handle, blade can be inserted
from both sides, bayonet-shaped
210 mm



SIMON

OSI100248

Scalpel, straight
200 mm



Sinus and Hypophysectomy

HUNT

OSI120316 Ø 5 mm

Forceps, angled, jaw serrated
200 mm



HUNT

OSI260521 Ø 5 mm

Forceps, bayonet-shaped, jaw serrated
200 mm

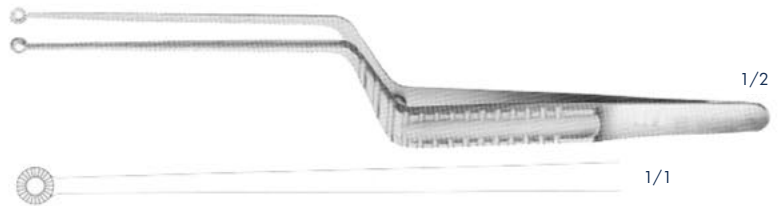

Sinus and Hypophysectomy

YASARGIL

OSI260522 Ø 3 mm
 Forceps, bayonet-shaped, jaw serrated
 200 mm

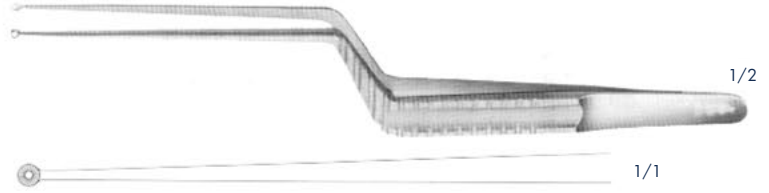

YASARGIL

OSI120215 Ø 3 mm
OSI120216 Ø 5 mm
 Tumour grasping forceps, jaw spoon-shaped
 220 mm

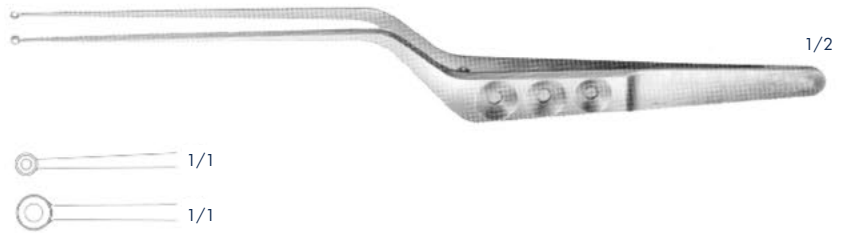

YASARGIL

OSI120217 Ø 3 mm
OSI120218 Ø 5 mm
 Tumour grasping forceps, jaw flat, serrated
 220 mm



HEIFETZ

OSI120219 Ø 3 mm
OSI120220 Ø 5 mm
 Tumour grasping forceps, curette jaw, toothed
 220 mm

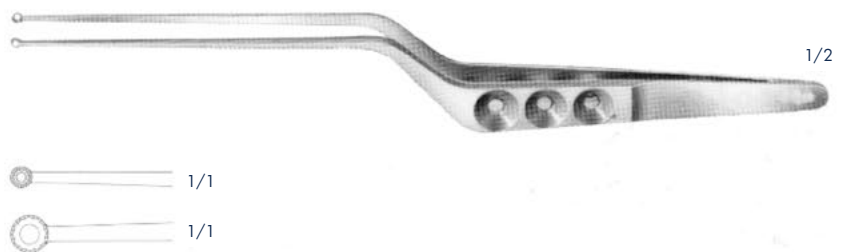

Adenoidectomy - Tonsillectomy

HARTMANN

OSI250752

Tongue depressor with fenestrated handle

150 mm



TOBOLD

OSI250754

Tongue depressor

160 mm

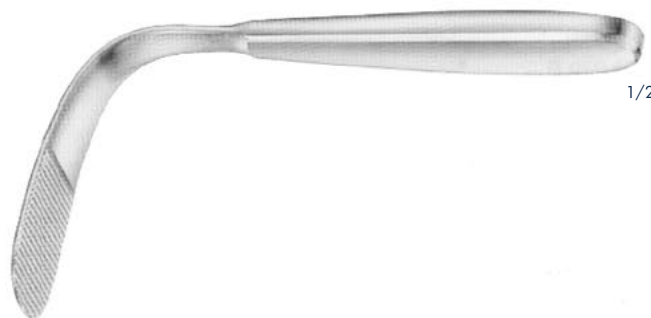

LACK

OSI260523 13 mm

OSI260524 19 mm

OSI260525 22 mm

Tongue depressor, curved

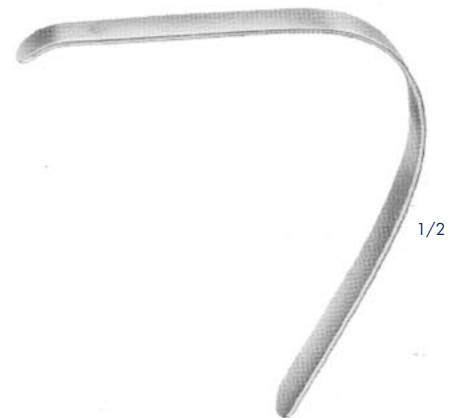

WEDER

OSI250756

OSI250757

Tongue depressor, fenestrated

150 mm



Adenoidectomy - Tonsillectomy

WHITEHEAD

- OSI260526** 90 mm
- OSI250724** 110 mm
- OSI250725** 130 mm
- OSI250726** 150 mm

Mouth gags

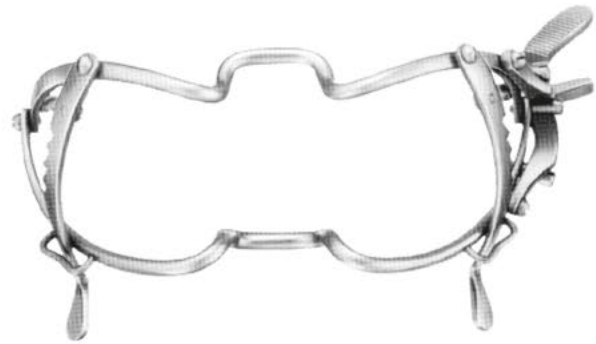

WHITEHEAD

- OSI260527** 110 mm
- OSI250727** 130 mm

Mouth gags with tongue depressor



WHITEHEAD-JENNINGS

- OSI250728** 90 mm
- OSI250729** 110 mm
- OSI250730** 130 mm
- OSI250731** 150 mm

Mouth gags

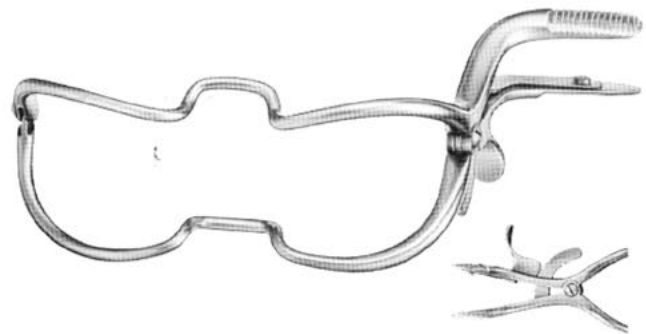

DINGMANN

- OSI260528**

Mouth gag

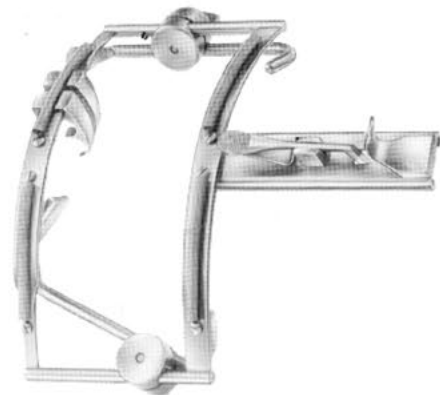

Adenoidectomy - Tonsillectomy

DAVIS-MEYER
OSI260529

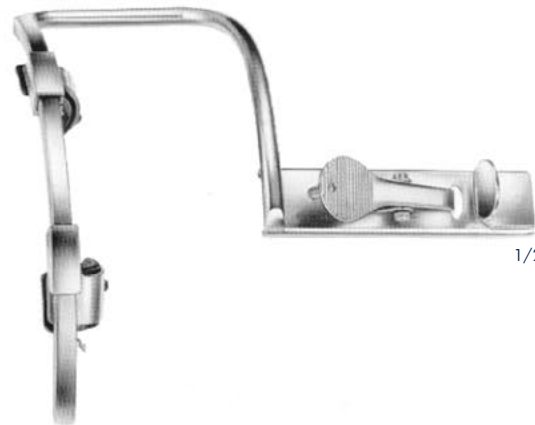

1/2

OSI260530
Silicone insert only

OSI260531
Plate blade to use with **OSI260529** for toothless patients



DAVIS-BOYLE
OSI260532

Frame only for adults



1/2

DAVIS-BOYLE
OSI250712

Frame only, for children

OSI260533
Frame only, for adolescents



1/2

MCIVOR
OSI250719

Frame only, suitable for all tongue depressors



1/2

Adenoidectomy - Tonsillectomy

RUSSEL-DAVIS

- OSI260534** 29 x 67 mm
- OSI260535** 33 x 75 mm
- OSI260536** 38 x 85 mm
- OSI260537** 40 x 92 mm
- OSI260538** 46 x 100 mm

Tongue blades, a groove holds the endotracheal tube, protects it from moving, kinking or closure by teeth, suitable for all frames on back page

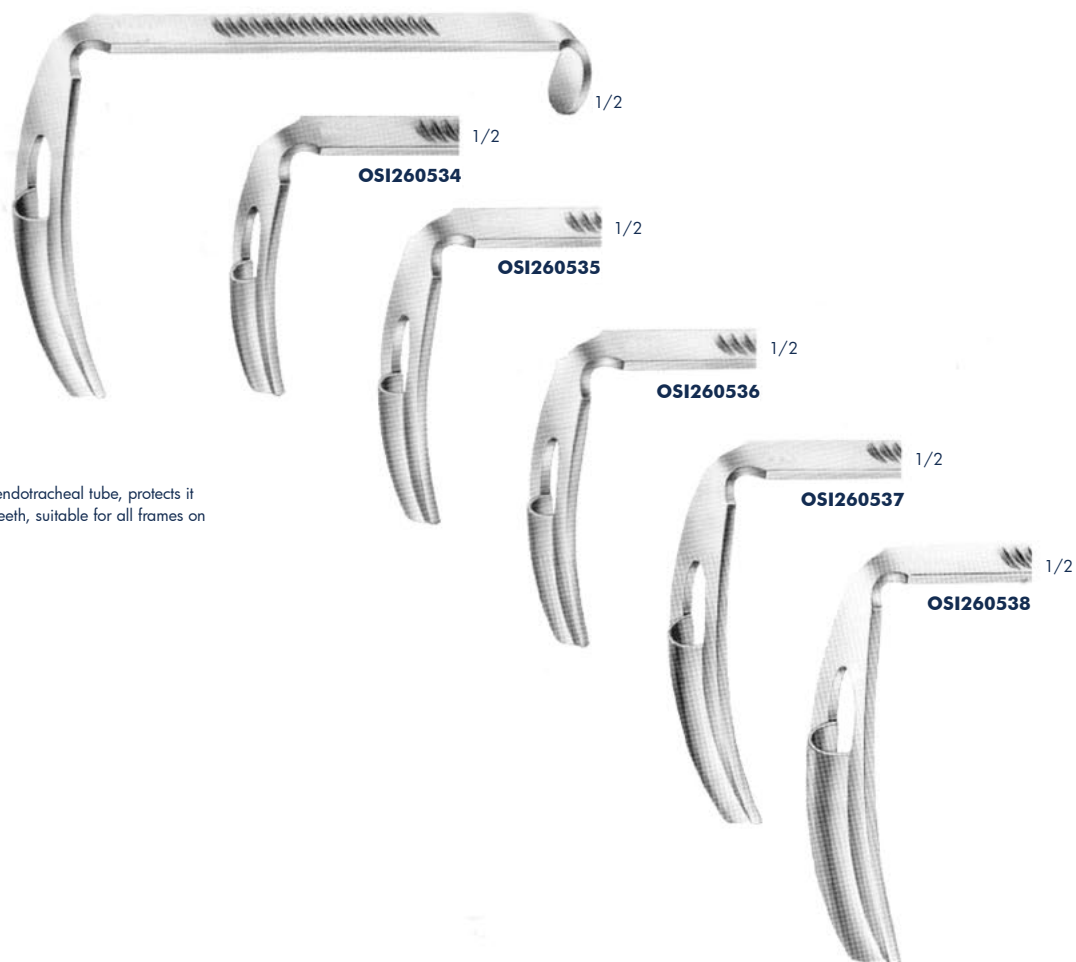

RUSSEL-DAVIS

- OSI260539** 18 x 57 mm
- OSI260540** 22 x 67 mm
- OSI260541** 25 x 75 mm

Tongue blades only, narrow pattern, with groove for endotracheal tubes, suitable for all frames on back page



Adenoidectomy - Tonsillectomy

GAST

OSI260542 28 x 64 mm

OSI260543 34 x 74 mm

OSI260544 38 x 87 mm

Tongue blades only, with groove for endotracheal tubes and lateral slot, suitable for all frames on two back page

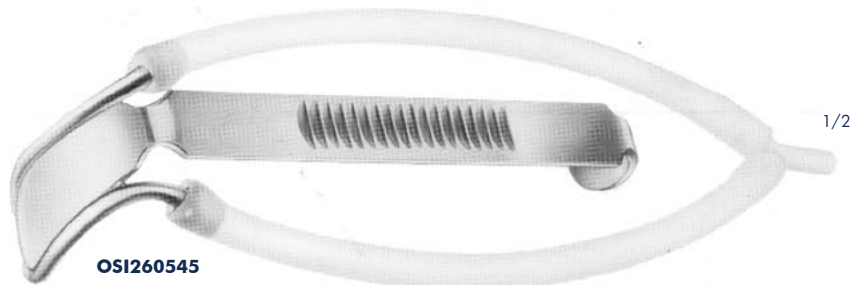
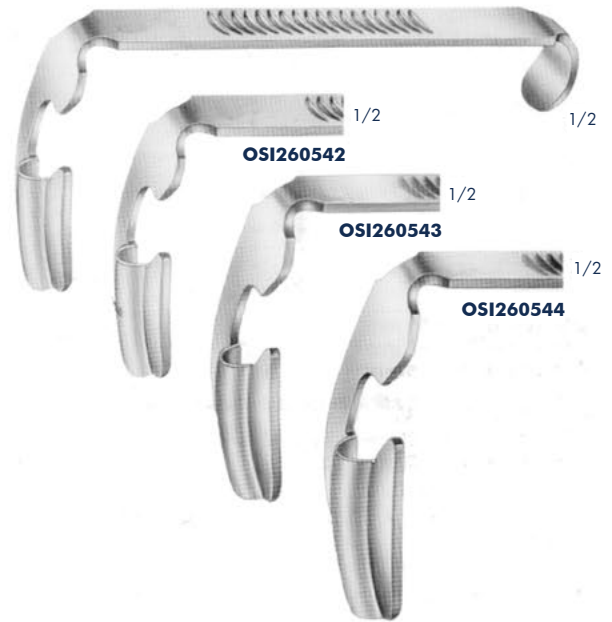

DAVIS-MEYER

OSI260545 29 x 70 mm

OSI260546 30 x 75 mm

OSI260547 31 x 80 mm

OSI260548 32 x 85 mm

OSI260549 33 x 95 mm

OSI260550 33 x 100 mm

OSI260551 34 x 105 mm

Tongue blades only, with tubing set for anesthesia channel, suitable for all frames on two back page



Adenoidectomy - Tonsillectomy

DOUGHTY

OSI260552	65 mm
OSI260553	75 mm
OSI260554	90 mm
OSI260555	102 mm
OSI260556	115 mm

Tongue blades, with slot for endotracheal tubes for use with Davis-Boyle frames **OSI260532, OSI250712, OSI260533**



OSI260557	65 mm
OSI260558	75 mm
OSI260559	90 mm
OSI260560	102 mm

Tongue blades, plain for use with Davis-Boyle frames
OSI260532, OSI250712, OSI260533

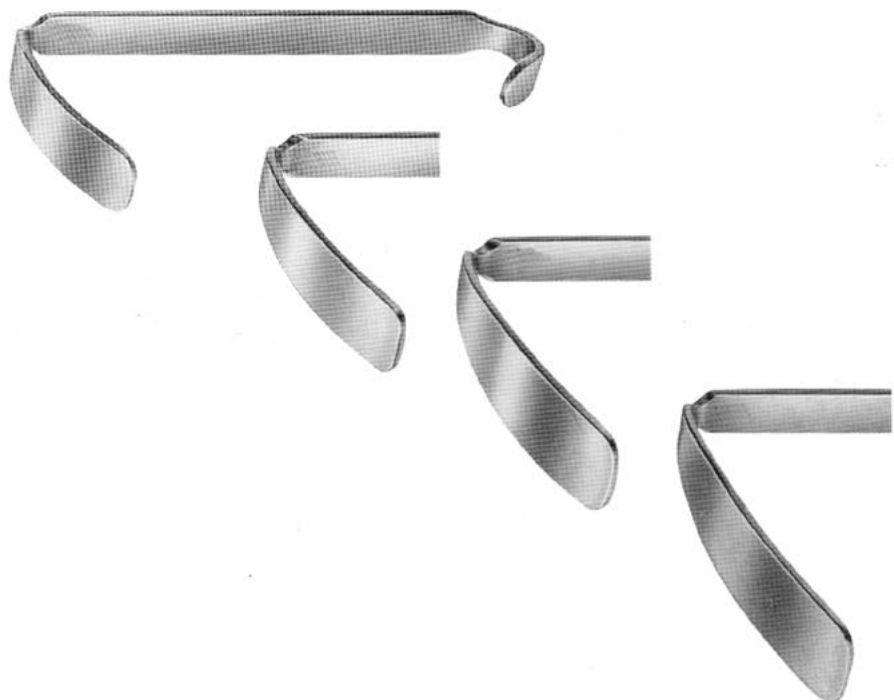

Adenoidectomy - Tonsillectomy

NEGUS

OSI260561

Chest Support, for use with tongue blades and mouth gag



DRAFFIN

OSI260562

Bipod fitted with 4 rings for varying heights



MAGAURAN

OSI260563

Plate for holding Draffin bipod

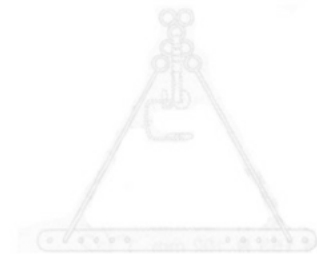

HAYFORK

OSI260564

Suspension apparatus for use with Davis-Boyle frame and blades

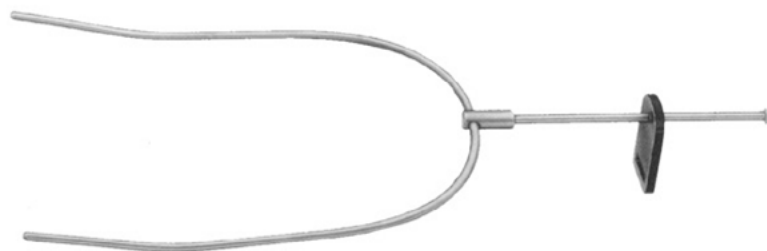

Adenoidectomy - Tonsillectomy

MARSCHIK-KRONE

OSI260565

Tonsil holding forceps
205 mm

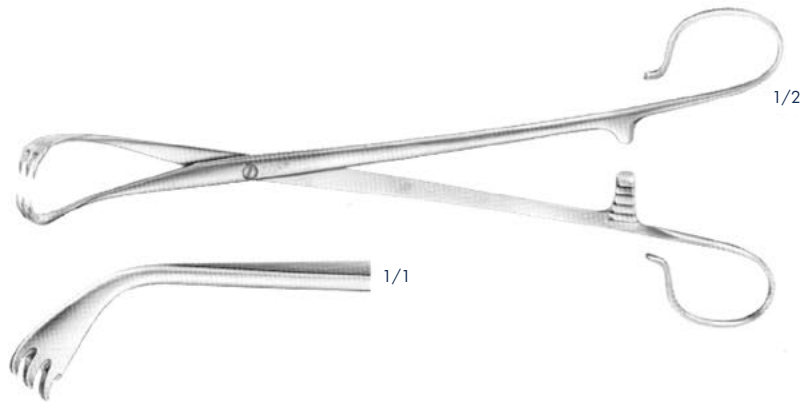

ABRAHAM

OSI260566

Tonsil holding forceps
205 mm

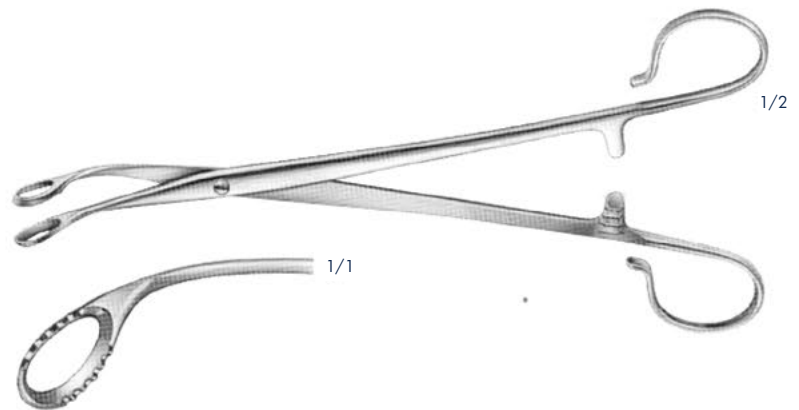

BLOHMKE

OSI260129

Tonsil holding forceps
205 mm

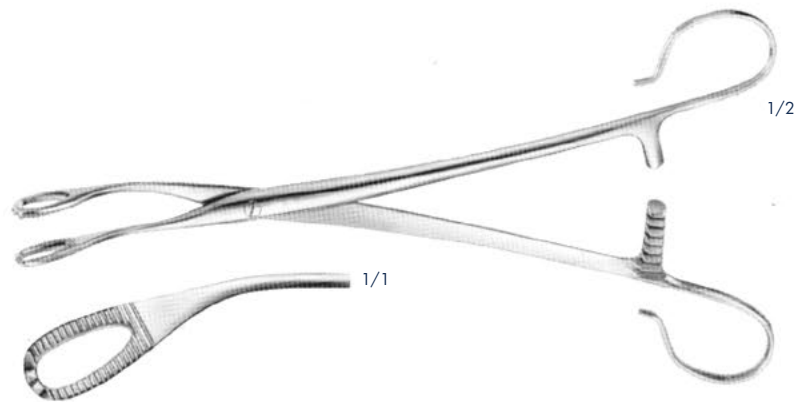

DENIS BROWNE

OSI260567

Tonsil holding forceps
200 mm

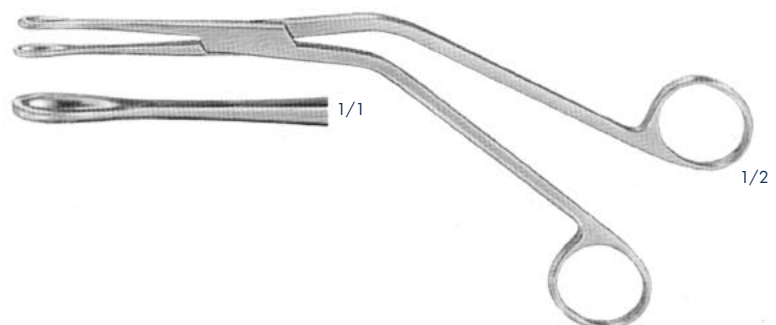

Adenoidectomy - Tonsillectomy

MARSCHIK

OS1260568

Tonsil forceps
220 mm

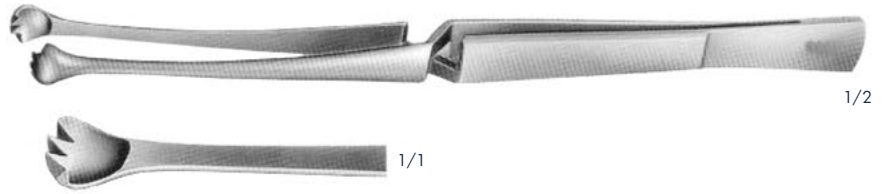

YANKAUER

OS1160205

Tonsil suction tube,
with central boring
295 mm

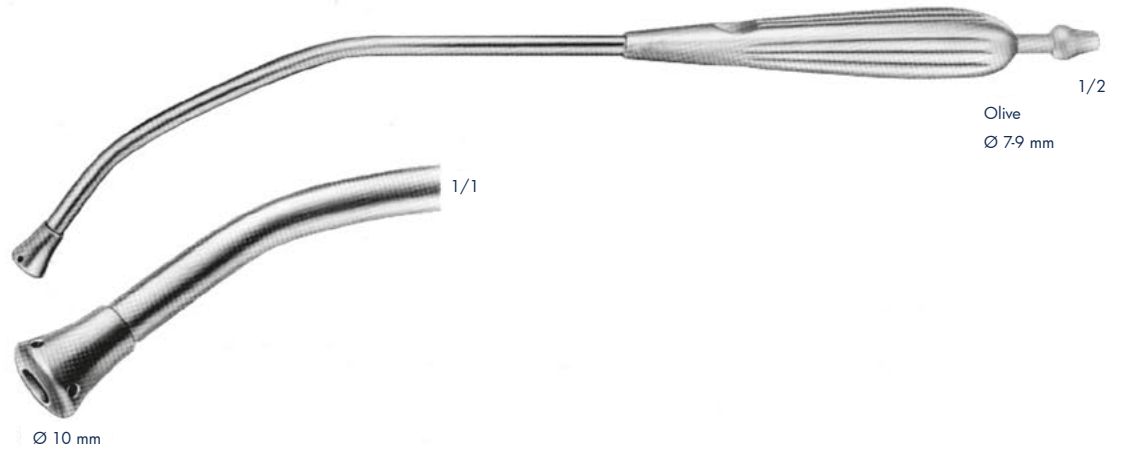

ROWBOTHAM

OS1160405

Suction cannula with stylet
295 mm



Adenoidectomy - Tonsillectomy

LOPEZ-REINKE

OSI160429

Tonsil suction dissector
235 mm



HURD

OSI260116

Tonsil dissector and pillar retractor
215 mm

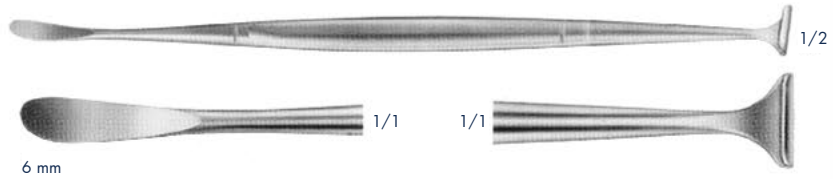

HURD

OSI260569

Tonsil dissector and pillar retractor
215 mm

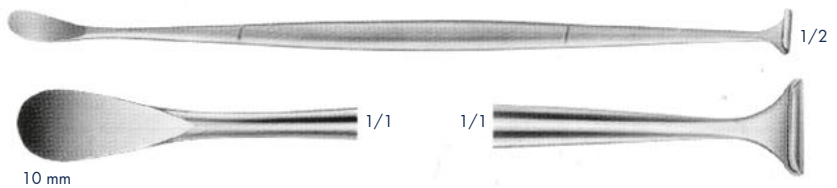

HENKE

OSI260117

Tonsil dissector and pillar retractor
235 mm



HENKE

OSI260118

Tonsil dissector and pillar retractor
235 mm

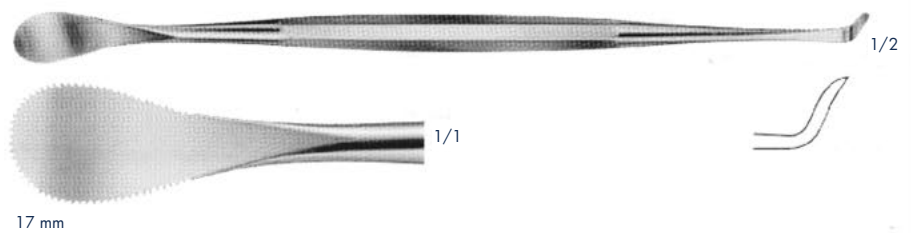

GWYNNE EVANS

OSI260570 6 mm

OSI260571 8 mm

Tonsil dissector and pillar retractor
200 mm



SYME

OSI260572

Tonsil dissector, double ended
185 mm

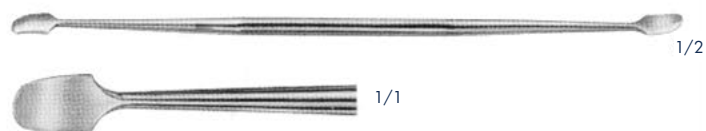

MOLLINSON

OSI260573

Tonsil dissector and pillar retractor, semi-sharp
210 mm



Adenoidectomy - Tonsillectomy

WAUGH

OSI120337

Delicate dissecting forceps

200 mm

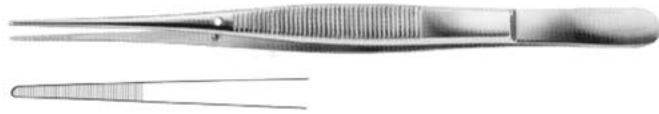

WAUGH

OSI260574

Delicate tissue forceps

200 mm

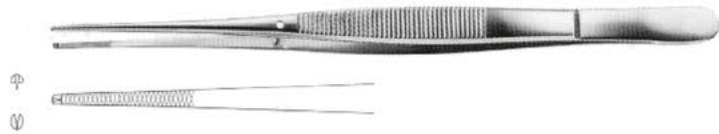

REMMINGTON-HOBBS

OSI260575

Monopolar diathermy forceps, serrated jaws

250 mm



REMMINGTON-HOBBS

OSI260576

Monopolar diathermy forceps, 1 x 2 teeth

270 mm

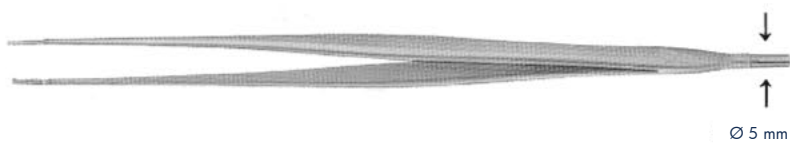

REMMINGTON-HOBBS

OSI260577

Monopolar diathermy forceps, angled, serrated jaws

250 mm



FOWLER

OSI100261

Tonsil knife

200 mm



ABRAHAM

OSI260106

Tonsil knife

215 mm



BRÜNING'S

OSI260107

Tonsil knife

215 mm



FISHER

OSI260105

Tonsil knife

205 mm

HF cables see leaflet



Adenoidectomy - Tonsillectomy

THILENIUS

OSI260578

Tonsil abcess forceps
190 mm

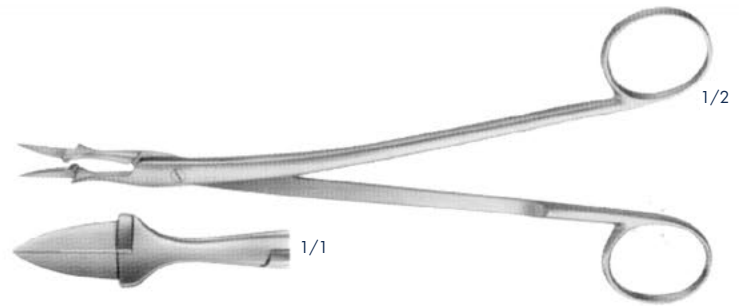

DUPLAY

OSI140145

Dressing forceps
210 mm

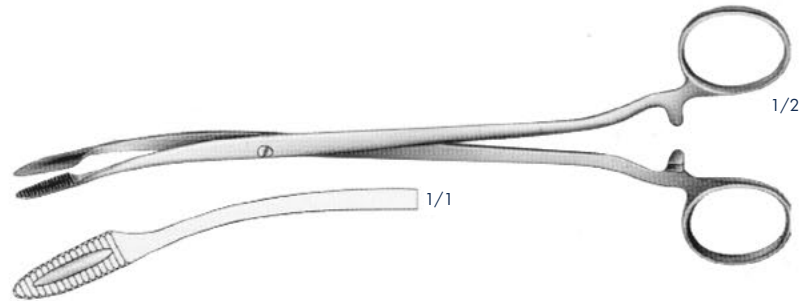

METZENBAUM

OSI110254

Dissecting scissors
180 mm

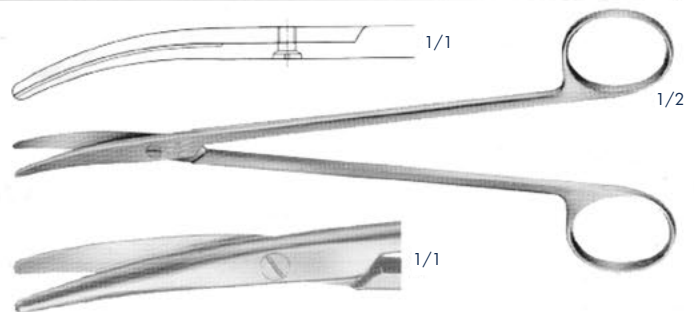

METZENBAUM

OSI110437

Dissecting scissors, curved
180 mm

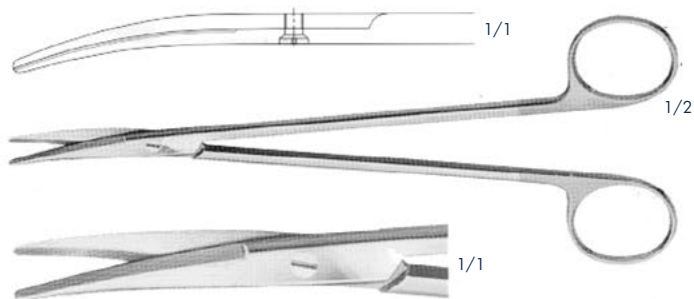

THOREK

OSI110678

Tonsil scissors
180 mm

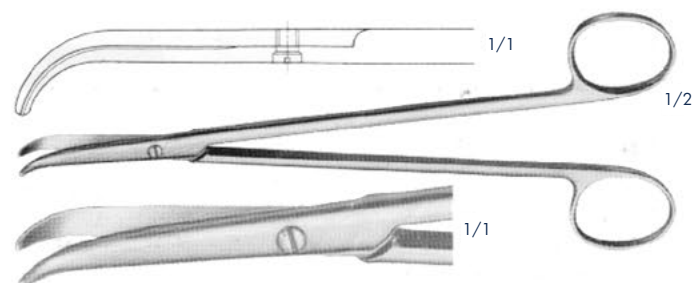

Adenoidectomy - Tonsillectomy

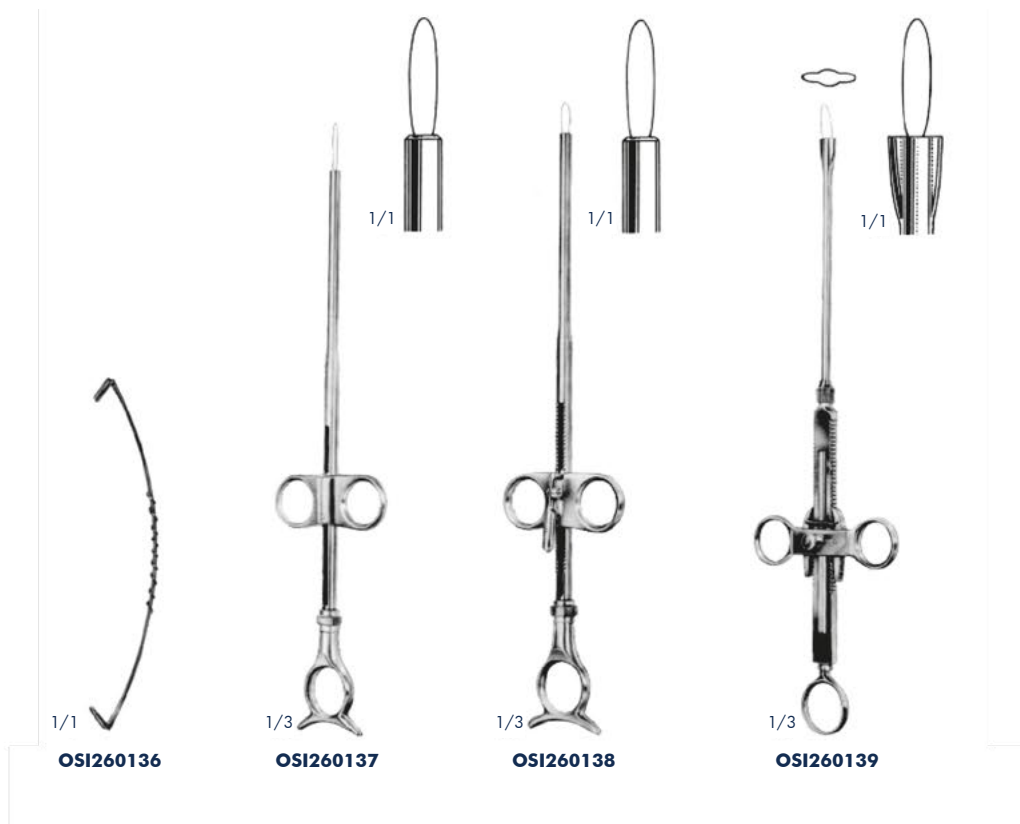

OSI250942 Ø 0,4 mm
Wire loops, sales unit: PH=Package of 100 pieces

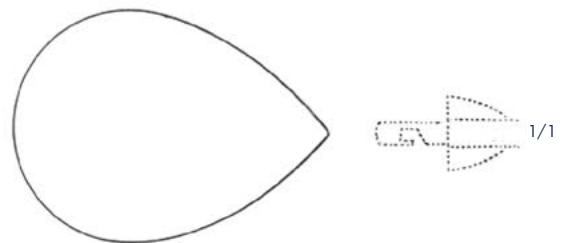

OSI250943 Ø 0,4 mm
Wire loops, sales unit: PH=Package of 100 pieces

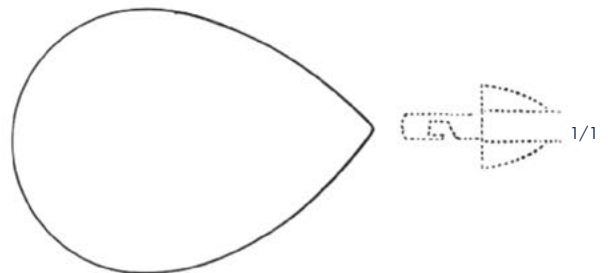

OSI250414 Ø 0,3 mm
Snare wire in coils of 10 m



Adenoidectomy - Tonsillectomy

TYDING

OSI260140

Tonsil snare with detachable straight tip



OSI260580

Tip only, straight



OSI260581

Veeder tip only, to be used with



OSI180483

Wire cutting and bending pliers

160 mm

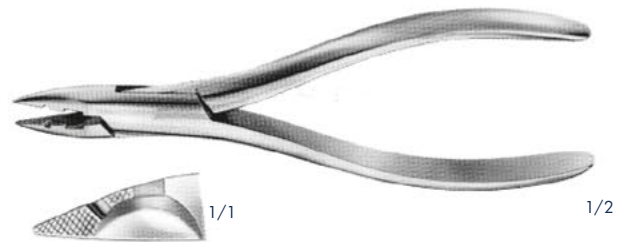

OSI110412

Wire cutting scissors, on blade serrated

120 mm

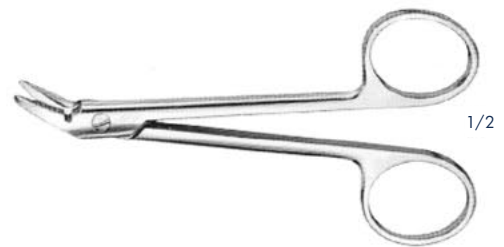

OSI110449

Wire cutting scissors

120 mm

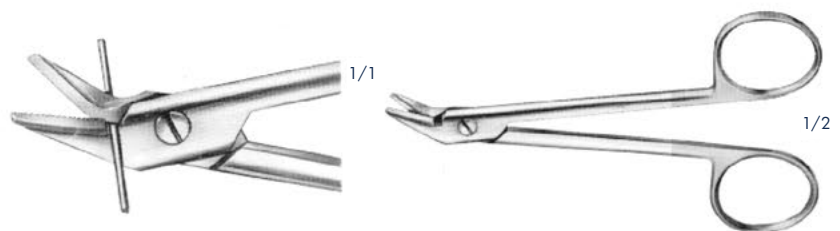

Adenoidectomy - Tonsillectomy

SLUDER-BALLENGER

OSI260582

OSI260583

OSI260584

Blades for tonsillotome handle

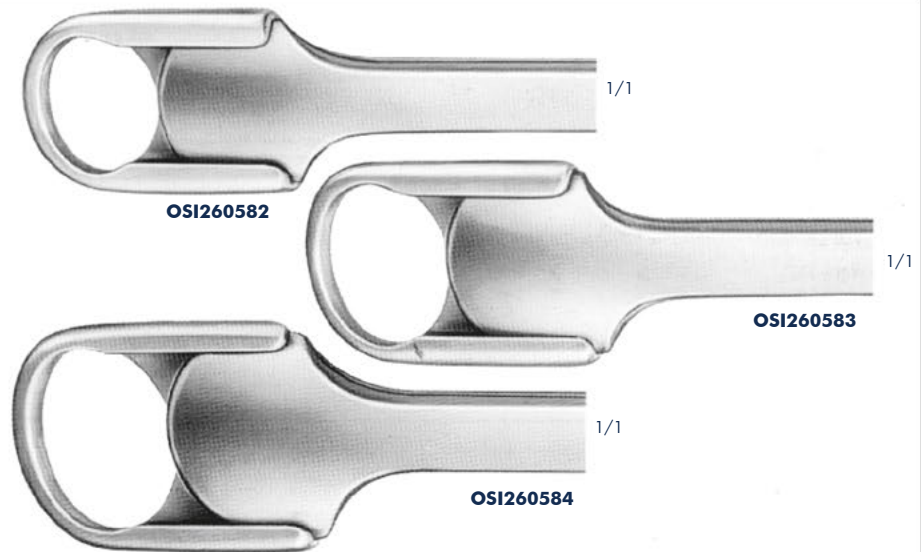

SLUDER-BALLENGER

OSI260585

Tonsillotome handle for blades



HARTMANN

OSI260145 Ø 13 mm

OSI260146 Ø 15 mm

Tonsil punches

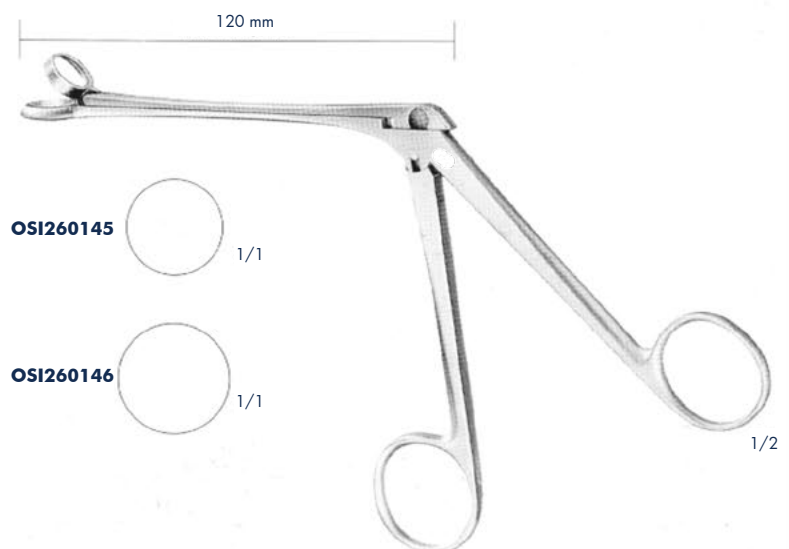

Adenoidectomy - Tonsillectomy

MIKULICZ

OSI130498

Tonsil artery forceps
185 mm

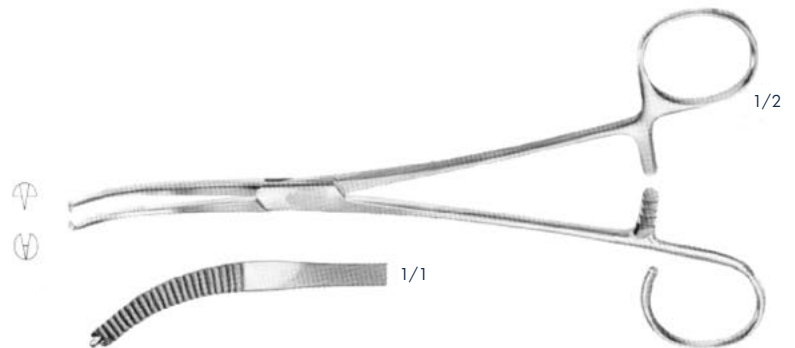

NEGUS

OSI130330

OSI130331

Tonsil artery forceps
190 mm

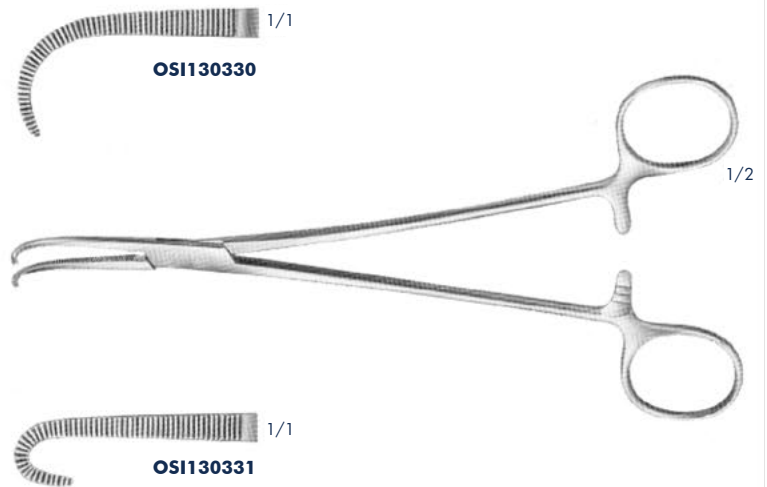

LUNIATSCHEK

OSI260586

Tonsil tampon plugger
180 mm

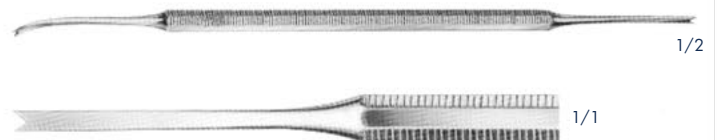

CORWIN

OSI260587

Tonsil haemostat with spring clamp and sliding collar
to hold the gauze pad in position

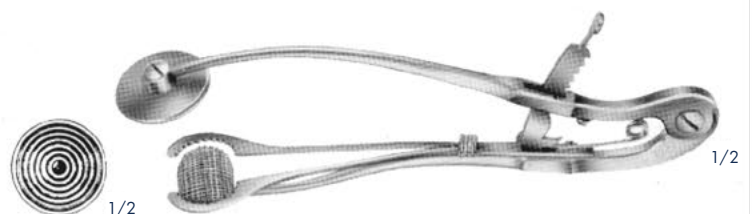

Adenoidectomy - Tonsillectomy

DESCHAMPS

OSI170414

Ligature needles, sharp, right, for the left hand



OSI170413

Ligature needles, sharp, left, for the right hand

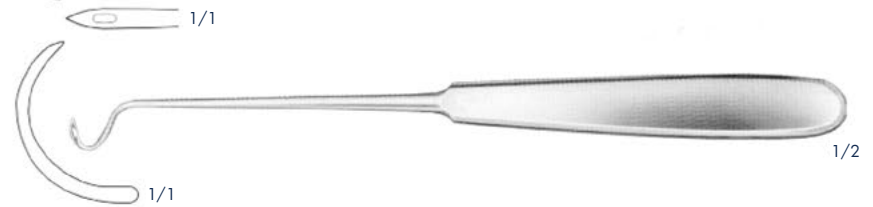

210 mm

HURD

OSI170410

Ligature needles, sharp, right, for the left hand



OSI170409

Ligature needles, sharp, left for the right hand



210 mm

CLAUS VAN EICKEN

OSI260113

Tonsil suture needle
250 mm



ROEDER

OSI260588

Ligature instrument, form E
260 mm

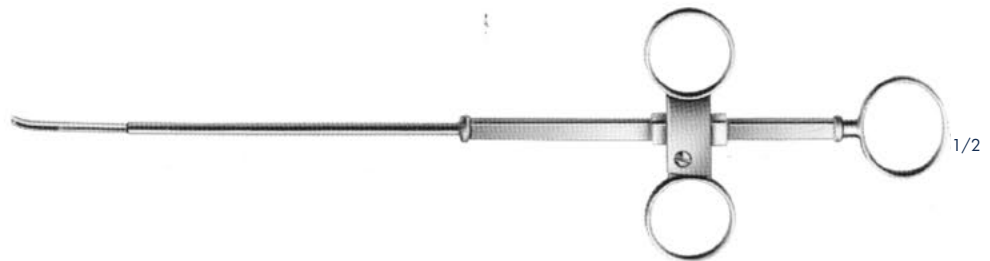

NEGUS

OSI260589

Knot tyer
205 mm



CLAUS VAN EICKEN

OSI260590

Suture hook (catcher)
210 mm

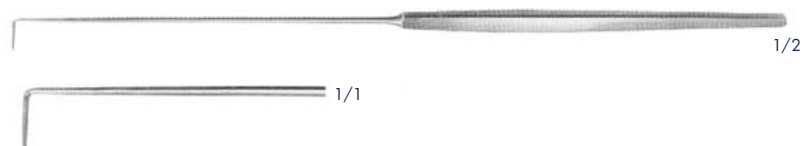

Adenoidectomy - Tonsillectomy

HASLINGER

OSI260591

Uvula retractor (palate retractor) self-retaining



SCHÖNBORN

OSI220127 13 x 6 mm

Uvula hook

200 mm

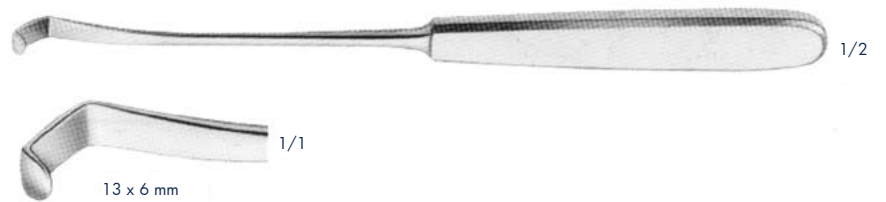

Adenoidectomy - Tonsillectomy



1/2

LA FORCE

- OSI250675
- OSI250676
- OSI250677
- OSI250678

Adenoid curettes
200 mm

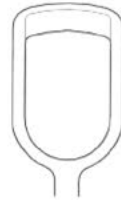

OSI250675



OSI250676

1/1

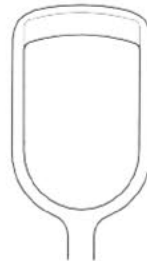

OSI250677

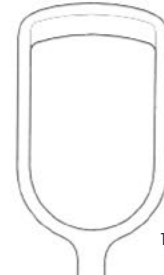

OSI250678

1/1

BARNHILL

- OSI260593
- OSI260594
- OSI260595

Adenoid curette with cage
212 mm



1/2

- OSI260596
- OSI260597

Adenoid curette with cage
214 mm



OSI260593

8,5 mm



OSI260594

10 mm



OSI260595

13 mm

1/1



OSI260596

15 mm



OSI260597

16,5 mm

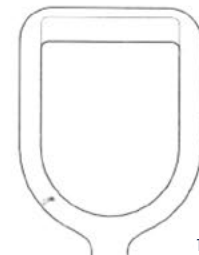

OSI260598

18 mm

1/1

OSI260598

Adenoid curette with cage
216 mm

Adenoidectomy - Tonsillectomy

LA FORCE

OSI250679

OSI250680

OSI250681

Adenotomes

230 mm



OSI250679



OSI250680

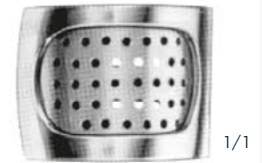

OSI250681

LA FORCE

OSI260599

OSI260600

OSI260601

Spare blades only, perforated, suitable for

OSI250679 - OSI250681

JATHO

OSI260602

Biopsy, forceps, for nasopharynx and hypopharynx, malleable shaft, right side opening

OSI260603

Biopsy, forceps, for nasopharynx and hypopharynx, malleable shaft, left side opening

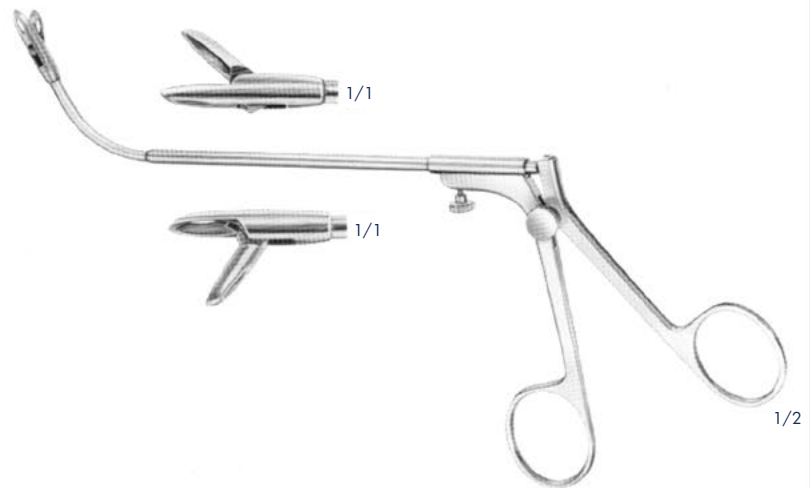

JATHO

OSI260604

Nasopharynx forceps

240 mm

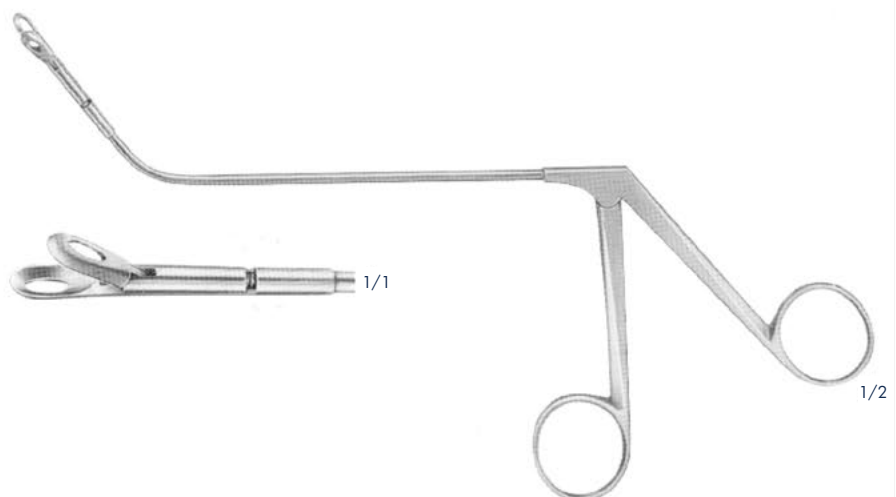

Adenoidectomy - Tonsillectomy

JURASZ

OSI260605

Adenoid cutting forceps for children
190 mm

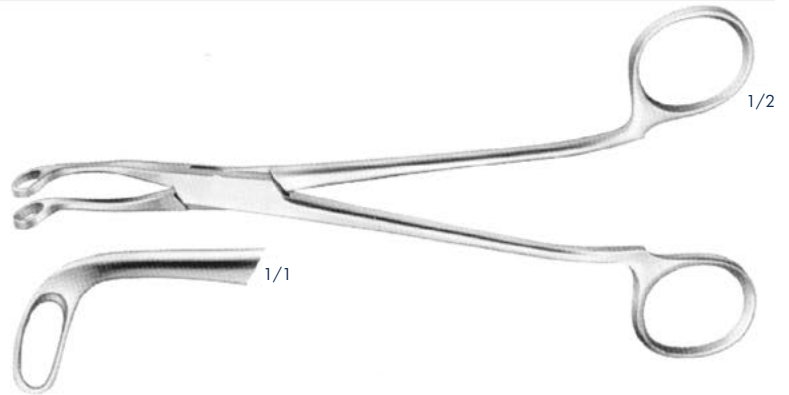

JURASZ

OSI260606

OSI260607

Adenoid cutting forceps
240 mm

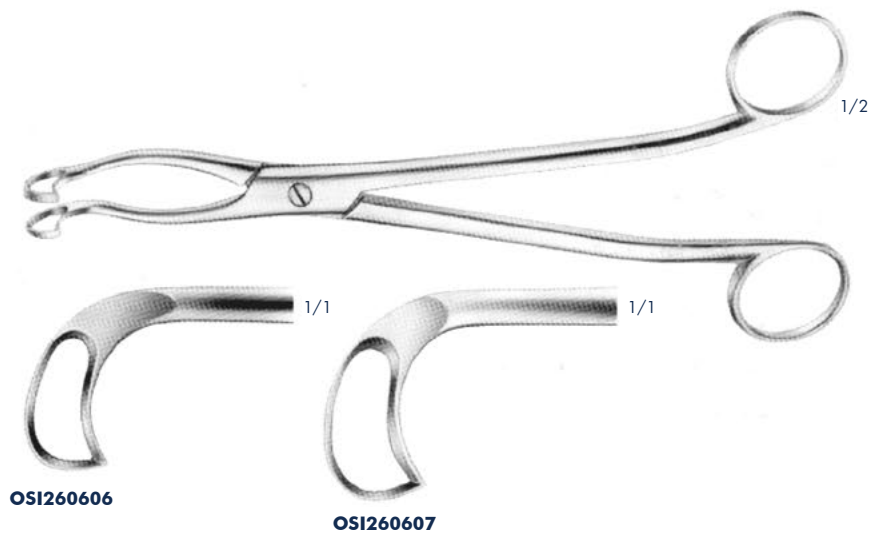

SCHMEDEN

OSI260385

Adenoid punch

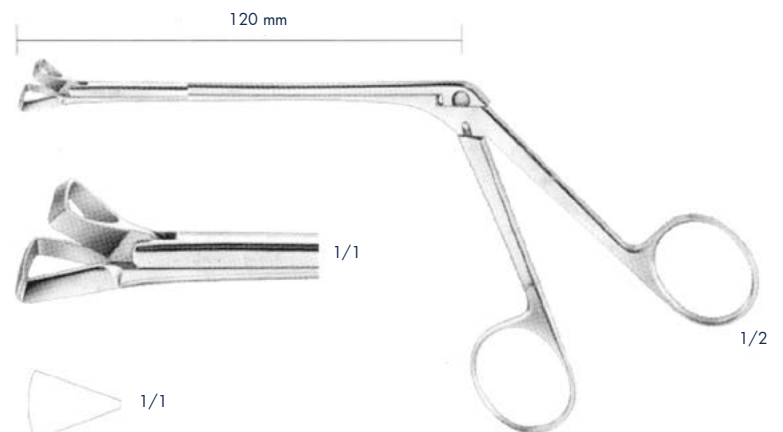

Adenoidectomy - Tonsillectomy

DUPLAY

OSI260608

Nasopharyngeal sponge holding forceps, s-shaped
190 mm

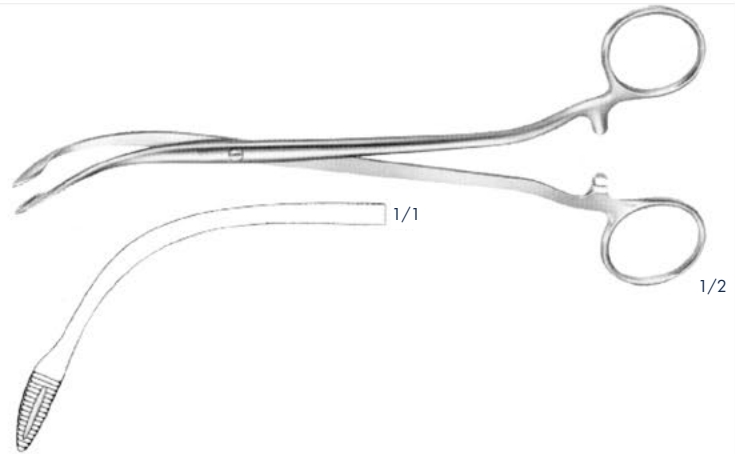

HARTMANN

OSI160256

Postnasal applicator, rough, spiral end
220 mm



SEIFFERT

OSI160239 Ø 1,0 mm

Salival probe, silver
180 mm



PERWITZSCHKY

OSI110586

Salival scissors
10 mm

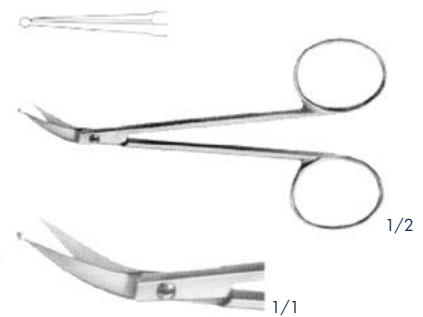

Adenoidectomy - Tonsillectomy

OSI260609 2 ml
OSI260610 5 ml
OSI260611 10 ml
 Syringe complete

OSI260612 2 ml
OSI260613 5 ml
OSI260614 10 ml
 Glass cylinder only

OSI260615 2 ml
OSI260616 5 ml
OSI260617 10 ml
 Luer-lock attachment

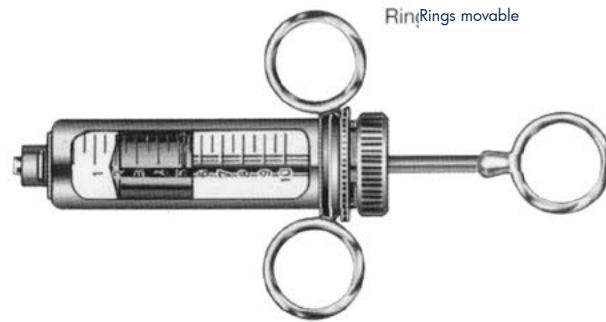

Septum - and tonsil syringes 200°C

OSI260618
 Tonsil needle, straight, with Luer-lock attachment



OSI260619
 Tonsil needle, strongly curved, with Luer-lock attachment

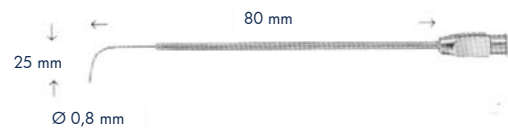

OSI260620
 Septum needle, angled, with Luer-lock attachment



OSI260621 25 mm, 115 mm, 0,8 mm
 Septum needle, bayonet-shaped, with Luer-lock attachment



Adenoidectomy - Tonsillectomy

OBWEGESER

OSI180341

Awl for zygomatic arch
230 mm



OSI180342

Maxillary awl
195 mm



MILLER

OSI250967

Curette
180 mm



LUCAS

OSI190765

Raspatory, spoon-shaped
180 mm



LUCAS

OSI190766

Raspatory, spoon-shaped
185 mm



MOLT

OSI190682

Raspatory, sharp
180 mm



MEAD

OSI190681

Raspatory, sharp
165 mm



CHOMPRET

OSI260623

OSI260624

OSI260625

OSI260626

Raspatory
150 mm

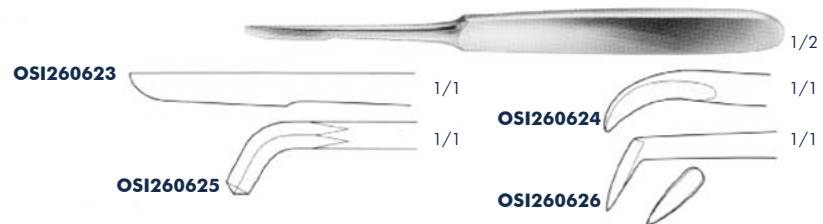

Adenoidectomy - Tonsillectomy

KOENIG

OSI250958

Elevator, slightly curved
155 mm



OSI190645

Elevator, strongly curved
155 mm



KOENIG

OSI190664

Raspatory
155 mm



OSI190710

OSI190711

Raspatory, strongly curved
170 mm



OSI190710 1/1



OSI190711 1/1



OSI260628

Raspatory, angled
200 mm



OSI190667

Raspatory, curved to side, right



OSI260666

Raspatory, curved to side, left
140 mm

OSI190667 1/1

OSI190666 1/1



Laryngology

OSI260779

Wick for spirit lamp, sales unit: PZ=Package of 10 pieces

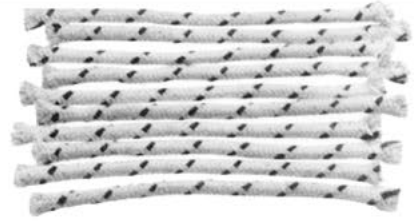

MICHEL

Rhinoscopic mirrors with interchangeable mirror inserts
250 mm



1/2

OSI100339

Ø 12 mm



1/1

OSI100339 Ø 12 mm

OSI100324 Ø 14 mm

Spare mirror, only

OSI100324

Ø 14 mm



1/1

REICHERT

OSI260211

Epiglottis retractor
230 mm



1/2

KILLIAN

OSI260627

Laryngeal applicator
250 mm



1/2

FEIN

OSI160177

Laryngeal applicator
280 mm

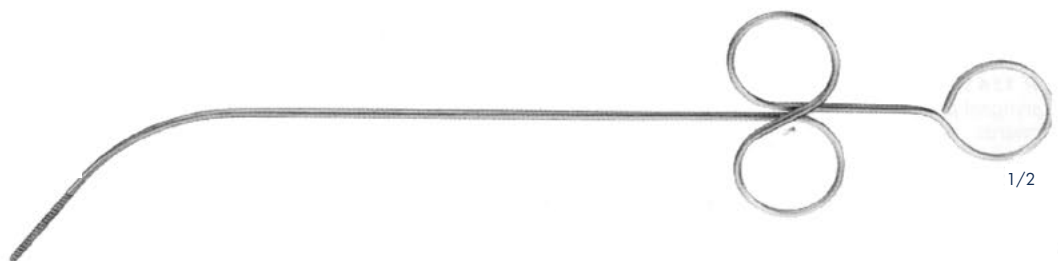

1/2

Laryngology

FRAENKEL OSI260629

Laryngeal forceps,
both sides opening,
oval

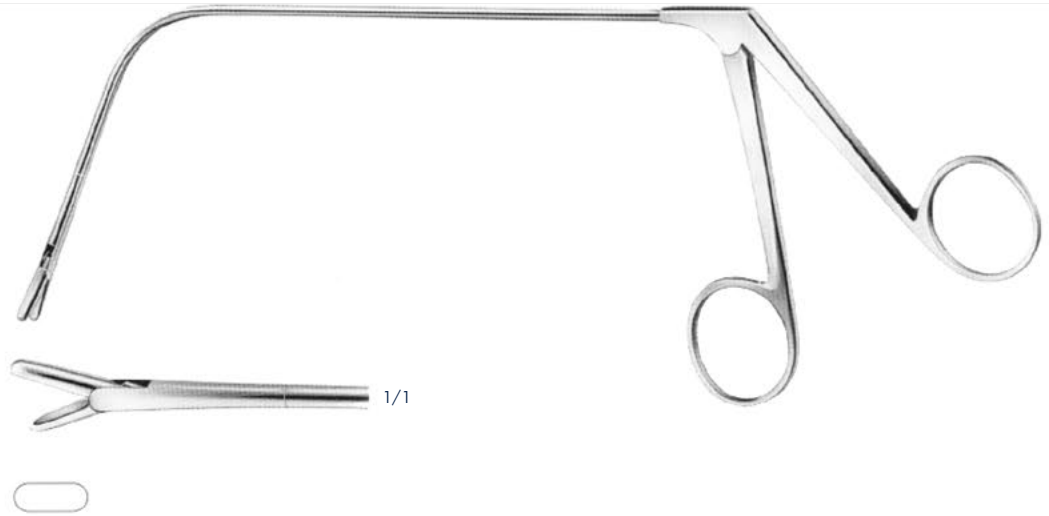

KILLIAN OSI250477

Laryngeal scissors, double Action
220 mm

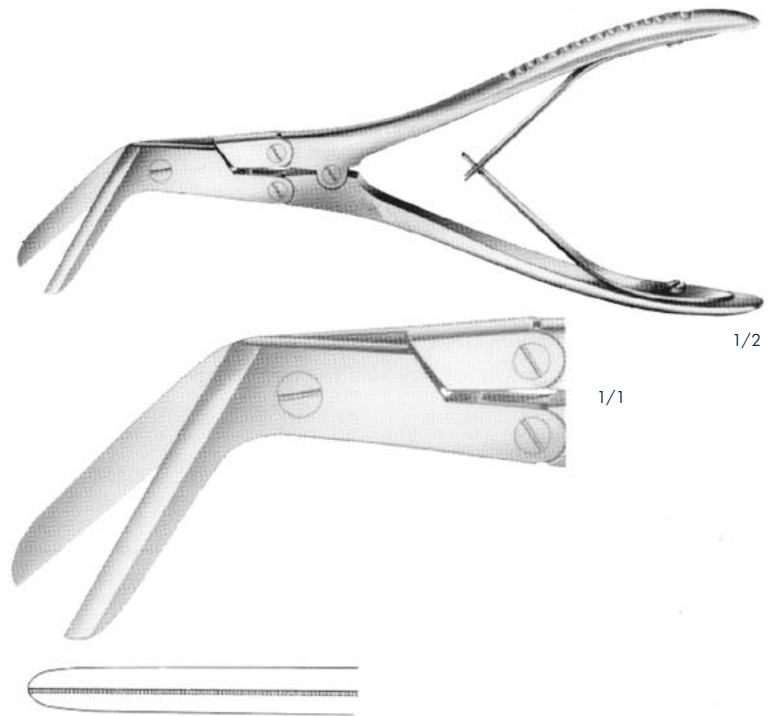

KALUSKAR OSI260630

Pharyngeal foreign body forceps

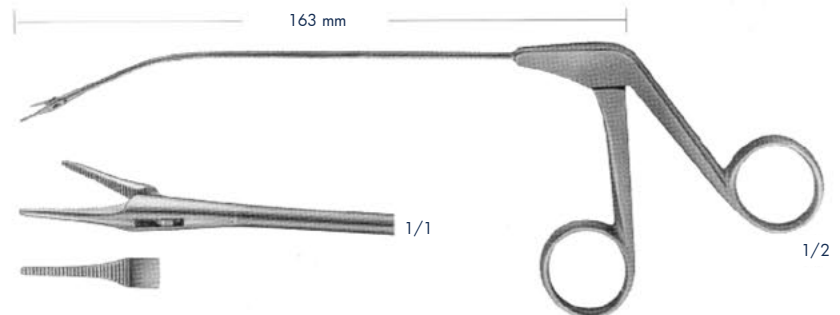

BRÜNNINGS

OSI260181

Curved tube with stylet, rigid, for indirect laryngeal use
200 mm

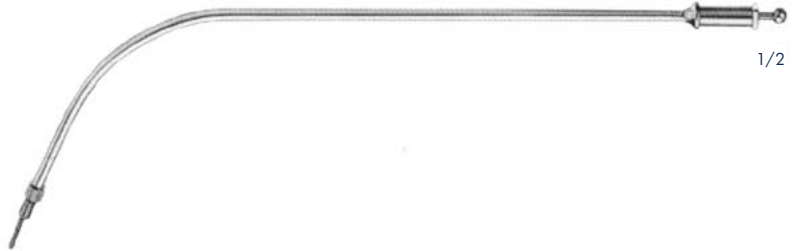

OSI260631

Curved tube with stylet, malleable, for indirect laryngeal use
200 mm

BRÜNNINGS

OSI260178 200 mm

OSI260632 250 mm

OSI260179 300 mm

OSI260633 350 mm

OSI260180 400 mm

OSI260634 500 mm

Straight tubes with stylet, stiff



Laryngology

OSI260182



1/1

**KAHLER
OSI260635**



1/1

**EICKEN
OSI260638**



**LANGE
OSI260191**

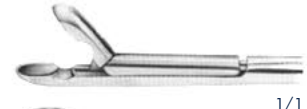

1/1

**LANGE
OSI260636**



1/1

**KRAUSE
OSI260192
OSI260193**



1/1

OSI260192 OSI260193

**FRAENKEL
OSI260184**



1/1

**SCHEINMANN
OSI260186**



1/1

**FRAENKEL
OSI260639**



1/1

**SCHUMACHER
OSI260199**



1/1

**SCHEINMANN
OSI260185**



1/1

**CORDES
OSI260195**



1/1

BRÜNINGS
A OSI260640 Ø 2 mm
A OSI260187 Ø 3 mm
A OSI260188 Ø 4 mm



1/1

OSI260187 OSI260188

**CORDES
OSI260201**



1/1

**BRÜNINGS
OSI260641**



1/1

**STRUYCKEN
OSI260637**



1/1

Laryngology

OSI260642

Chest support and laryngoscope holder, complete for adults and children

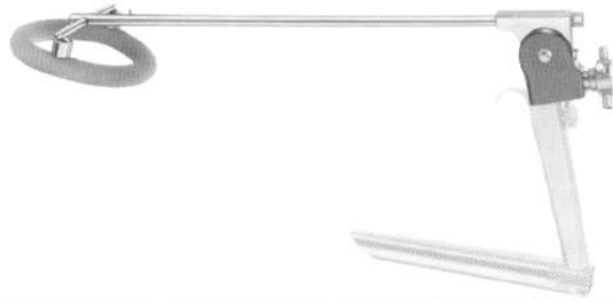

OSI260643

Operating laryngoscope,
for adults, large size
180 mm



OSI260644

Operating laryngoscope,
for adults, medium size
180 mm



OSI260645

Operating laryngoscope,
for adolescents, small size
180 mm



OSI260646

Operating laryngoscope,
for children
130 mm



OSI260647

Light guide for use with laryngoscopes **OSI260643**, **OSI260644**
OSI260645 and light source



OSI260648

Light guide for use with laryngoscopes **OSI260646** and light
source



OSI260649

Teeth protector



RNTNE HOSPITAL PATTERN

OSI260650

Operating laryngoscope, small, proximal 15 mm x 20 mm / distal 11 mm x 15 mm
120 mm



RNTNE HOSPITAL PATTERN

OSI260651

Operating laryngoscope, medium, proximal 15 mm x 24 mm / distal 11 mm x 15,5 mm
150 mm



RNTNE HOSPITAL PATTERN

OSI260652

Operating laryngoscope, large, proximal 19 mm x 28 mm / distal 13 mm x 18 mm
150 mm



RNTNE HOSPITAL PATTERN

OSI260653

Operating laryngoscope, medium, proximal 20 mm x 22 mm / distal 14 mm x 15 mm
149 mm



RNTNE HOSPITAL PATTERN

OSI260654

Operating laryngoscope, large, proximal 16 mm x 28 mm / distal 15 mm x 18 mm
149 mm



Laryngology

OSI260655

Fibrelight carrier, standard, for use with laryngoscopes
Universal fitting



FRASER

OSI260656

Operating laryngoscope for neonates and infants proximal
14 mm x 18 mm / distal 9 mm x 11 mm
101 mm



FRASER

OSI260657

Operating laryngoscope for children aged 2-10, proximal
14 mm x 20 mm / distal 12 mm x 13 mm
108 mm



FRASER

OSI260658

Operating laryngoscope for small adults, proximal
15 mm x 20 mm / distal 13 mm x 14 mm
136 mm



FRASER

OSI260659

Operating laryngoscope for adults, proximal
20 mm x 28 mm / distal 15 mm x 16 mm
150 mm



FRASER

OSI260660

Operating laryngoscope for adults, proximal
11 mm x 25 mm / distal 14 mm x 18 mm
150 mm



RHYS-EVANS

OSI260661

Operating laryngoscope, proximal

13 mm x 21 mm / distal 15 mm x 17 mm

150 mm



OSI260662

Fibrelight carrier, standard for use with Rhys-Evans laryngoscope only
Universal fitting



LEWY

OSI260663

Chest support and laryngoscope holder, complete for adults and children



CARRUTH

OSI260664

Venturi tube for use with any operating laryngoscope

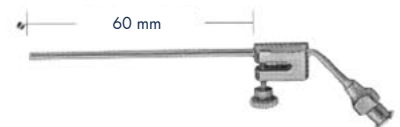

1/2

CARRUTH

OSI260665

Suction tube, malleable, for use with any operating laryngoscope

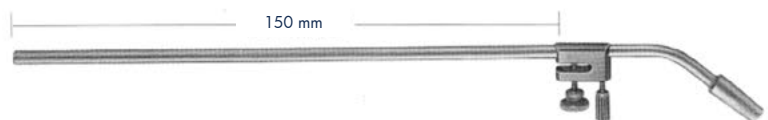

1/2

Laryngology



OSI260666 - OSI260678

Tubular shaft forceps, for endolaryngeal microsurgery
250 mm

OSI260666

Micro-laryngeal grasping forceps



OSI260667

Micro-laryngeal grasping forceps, curved to left



OSI260668

Micro-laryngeal grasping forceps, curved to right



OSI260669 Ø 2 mm

Micro-laryngeal, cup-shaped forceps, straight



OSI260670 Ø 2 mm

Micro-laryngeal, cup-shaped forceps, curved to left



OSI260671 Ø 2 mm

Micro-laryngeal, cup-shaped forceps, curved to right



OSI260672 Ø 2 mm

Micro-laryngeal, cup-shaped forceps, upward angled



OSI260673

Micro-laryngeal scissors, straight



OSI260674

Micro-laryngeal scissors, curved to left



Laryngology

OSI260675

Micro-laryngeal scissors, curved to right



1/1

OSI260676

Micro-laryngeal scissors, upward angled



1/1

WEERDA

OSI260677

Cartilage forceps
250 mm



1/1

OSI260678

Laryngeal needle holder
225 mm



1/1

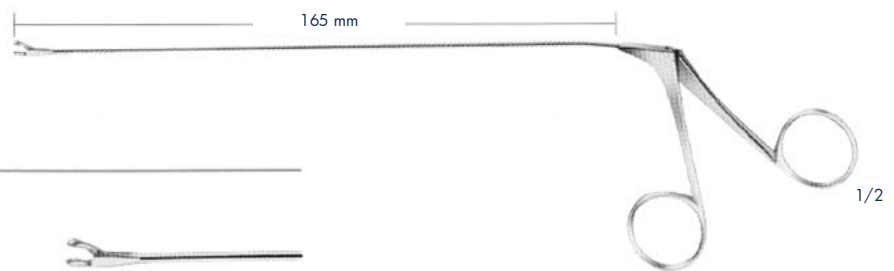

OSI260484 Ø 2,5 mm

Forceps, scoop-shaped, sharp
165 mm



1/1

YASARGIL-NICOLA

OSI260485

Forceps, long conical jaws
165 mm



1/1

NICOLA

OSI260486

Scissors, straight
165 mm



1/1

Laryngology

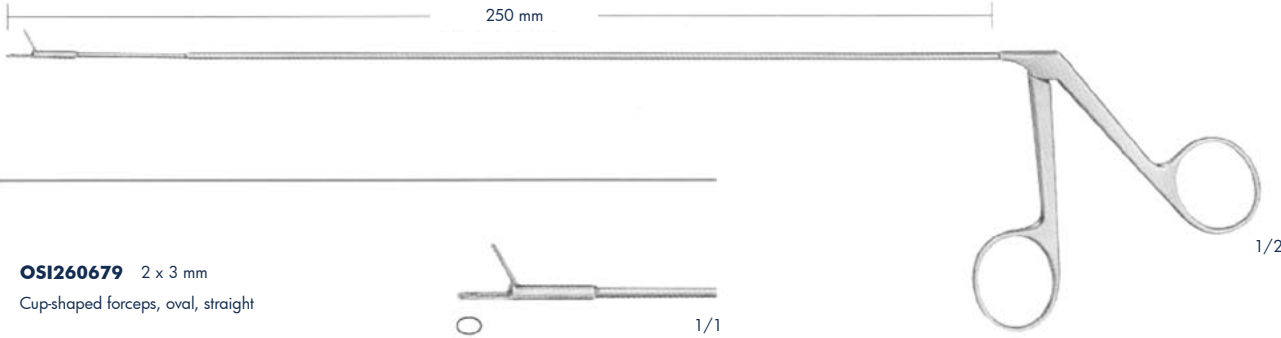

OSI260679 2 x 3 mm
Cup-shaped forceps, oval, straight



OSI260680
Cutting forceps, with fenestrated jaw, sharp, straight

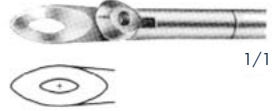

OSI260681
Biopsy punch, 90° angled



OSI260682
Laryngeal snare



OSI260683
Snare wires, Package of 12 pieces (not illustrated)

Laryngology

OSI260684 - OSI260690
Laryngeal instruments for use with handle

250 mm

1/3

OSI260684
Micro-laryngeal sickle knife

1/1

OSI260685
Micro-laryngeal separator, oval blade, horizontal

1/1

OSI260686
Micro-laryngeal separator, oval blade, vertical

1/1

OSI260687 Ø 2 mm
Round cutting knife, 45° angled

1/1

OSI260688
Hook, 90° angled, blunt

1/1

OSI260689
Probe, 30° backwards curved

1/1

OSI260690
Micro-laryngeal suture guide, fork-shaped

1/1

OSI260691
Handle for use with instruments

1/2

HEERMAN
OSI260692
Handle for use with micro-laryngeal instruments
133 mm

1/2

OSI260693
Coagulation probe, insulated
260 mm

260 mm

diameter

Ø 5 mm

1/2

Laryngology

OSI160418

Suction cannula with rubber tip and LUER hub
500 mm



OSI160419

Suction cannula with rubber tip and LUER hub
350 mm



OSI160420 Ø 2,0 mm

OSI160421 Ø 2,5 mm

OSI160422 Ø 3,0 mm

Suction cannula with finger cut-off, thumb piece 90° to curve with LUER hub
250 mm

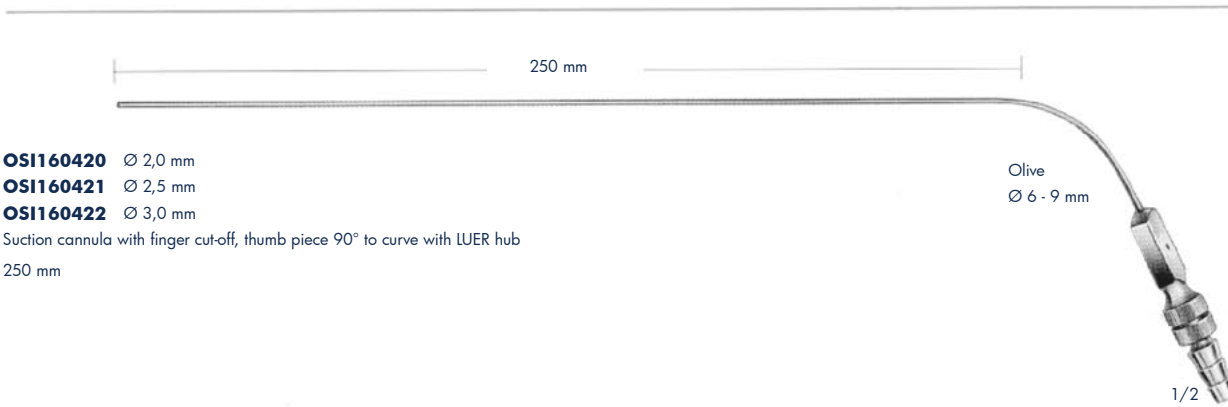

OSI260694

Injection needle with LUER-lock attachment
250 mm



OSI260695

Injection needle with LUER-lock attachment, 90° angled tip
250 mm

FERGUSSON

Ø	110 mm	130 mm	160 mm	200 mm
1,5 mm	OSI260280	OSI260286	OSI260292	OSI260298
2,0 mm	OSI260281	OSI260287	OSI260293	OSI260299
2,5 mm	OSI260282	OSI260288	OSI260294	OSI260300
3,0 mm	OSI260283	OSI260289	OSI260295	OSI260301
4,0 mm	OSI260284	OSI260290	OSI260296	OSI260302
5,0 mm	OSI260285	OSI260291	OSI260297	OSI260303

Suction cannula with finger cut-off and stylet,
thumb piece 90° to curve, with LUER hub

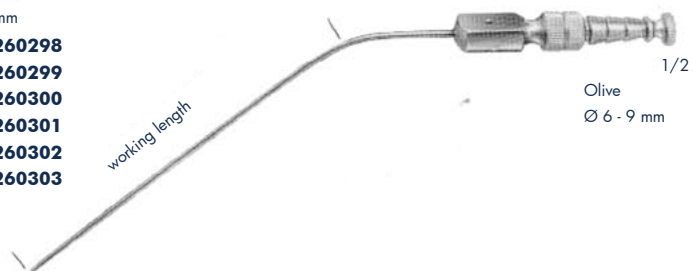

JACKSON

	diam. x length
OSI220177	Fig. 1 = 5 x 48 mm
OSI220178	Fig. 2 = 6 x 58 mm
OSI220179	Fig. 3 = 7 x 70 mm
OSI220180	Fig. 4 = 8 x 78 mm
OSI220181	Fig. 5 = 9 x 84 mm
OSI220182	Fig. 6 = 10 x 84 mm
OSI220183	Fig. 7 = 11 x 86 mm
OSI220184	Fig. 8 = 12 x 88 mm
OSI220185	Fig. 9 = 13 x 90 mm
OSI220186	Fig. 10 = 14 x 90 mm

Tracheal tubes with inner tube

Stainless steel
nicht
rostend



	diam. x length
OSI220187	Fig. 5 = 9 x 65 mm
OSI220188	Fig. 6 = 10 x 70 mm
OSI220189	Fig. 7 = 11 x 80 mm

Speaking tubes, German silver



	Outside diam.	Inside diam.	Length
OSI260696 Fig. 3	4,6 mm	3,5 mm	46 mm
OSI260697 Fig. 4	5,3 mm	4,0 mm	55 mm
OSI260698 Fig. 5	6,3 mm	5,0 mm	57 mm
OSI260699 Fig. 6	7,6 mm	6,0 mm	60 mm
OSI260700 Fig. 7	9,0 mm	7,0 mm	65 mm
OSI260701 Fig. 8	10,0 mm	8,0 mm	70 mm
OSI260702 Fig. 9	11,6 mm	9,0 mm	75 mm
OSI260703 Fig. 10	12,6 mm	10,0 mm	85 mm
OSI260704 Fig. 11	13,6 mm	11,0 mm	87 mm
OSI260705 Fig. 12	14,6 mm	12,0 mm	90 mm
OSI260706 Fig. 13	16,0 mm	13,0 mm	100 mm

Standard tubes with inner tube and tape, especially for permanent wearers after removal of the larynx (inside diameter measured on the most narrow part of standard tube)



Cleaning and maintenance:
in lukewarm water, if necessary with soap, do not boil!
Keep inner tube sliding with traces of paraffin oil
or silicon-spray

Disinfection:
with the usual disinfectants

Sterilisation:
with ethylene oxide (gas sterilization)

Bronchoscopy / Oesophagoscopy

Bronchoscopic and Esophagoscopic Forceps, both jaws movable



OSI260707 - OSI260710

Length of shaft
250 mm
Diam. of shaft
2,0 mm

OSI260707

For hard foreign bodies



OSI260708

For soft foreign bodies



OSI260709

For biopsy

Ø 3 mm



OSI260710

For biopsy and foreign bodies



Bronchoscopy / Oesophagoscopy

Bronchoscopic and Esophagoscopic Forceps, both jaws movable

OSI260711 - OSI260717

Length of shaft
350 mm
Diam. of shaft
3,0 mm

OSI260712 - OSI260718

Length of shaft
500 mm
Diam. of shaft
3,0 mm



1/2

**OSI260711
OSI260712**

For hard foreign bodies

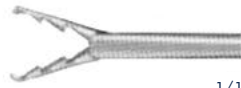

1/1

**OSI260713
OSI260714**

For soft foreign bodies



1/1

**OSI260715
OSI260716**

For biopsy



Ø 5 mm



1/1

**OSI260717
OSI260718**

For biopsy and foreign bodies



1/1

Cronchoscopy/Oesophagoscopy

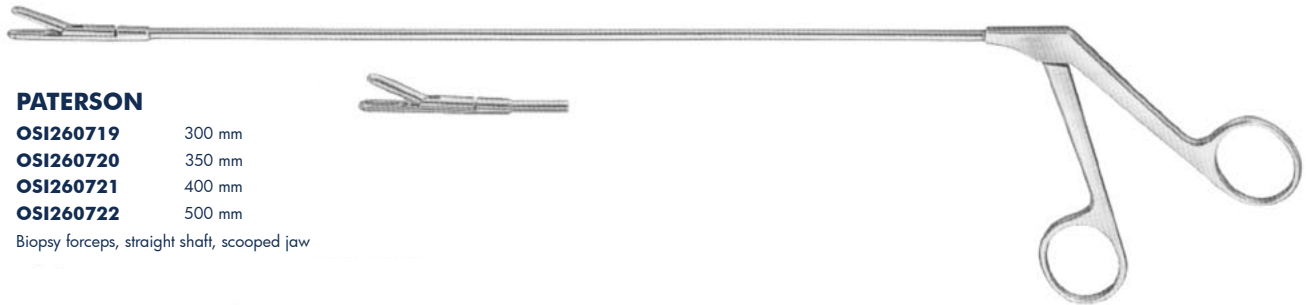

PATERSON

- OSI260719** 300 mm
- OSI260720** 350 mm
- OSI260721** 400 mm
- OSI260722** 500 mm

Biopsy forceps, straight shaft, scooped jaw

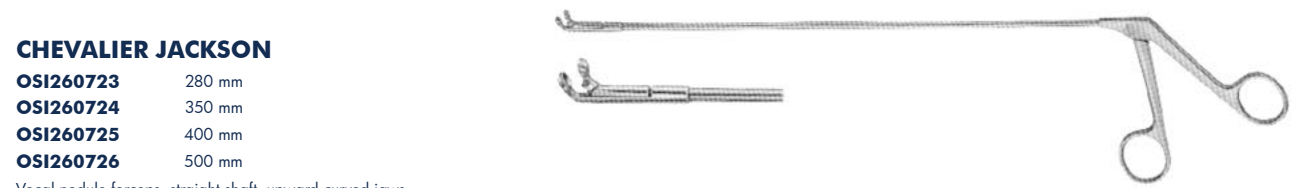

CHEVALIER JACKSON

- OSI260723** 280 mm
- OSI260724** 350 mm
- OSI260725** 400 mm
- OSI260726** 500 mm

Vocal nodule forceps, straight shaft, upward curved jaws

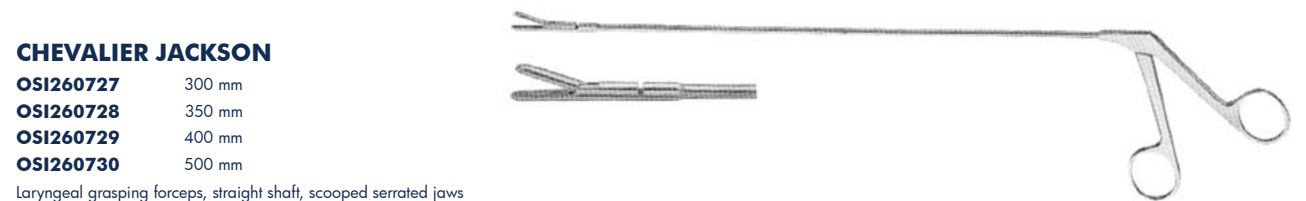

CHEVALIER JACKSON

- OSI260727** 300 mm
- OSI260728** 350 mm
- OSI260729** 400 mm
- OSI260730** 500 mm

Laryngeal grasping forceps, straight shaft, scooped serrated jaws

Bronchoscopy / Oesophagoscopy

Laryngeal Syringes 200°C

OSI260609 2 ml
OSI260610 5 ml
OSI260611 10 ml
Syringe complete

OSI260612 2 ml
OSI260613 5 ml
OSI260614 10 ml
Glass cylinder only

OSI260615 2 ml
OSI260616 5 ml
OSI260617 10 ml
Luer-lock attachment

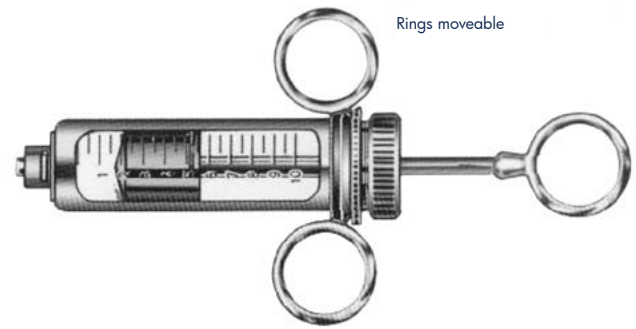

Septum - and tonsil syringes 200°C

OSI260731
Laryngeal cannula with Luer-lock attachment

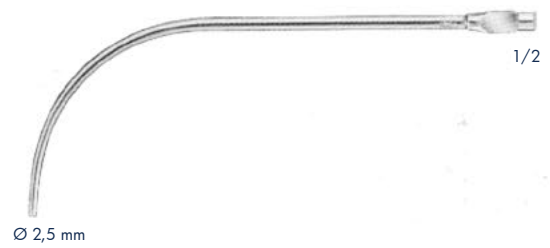

Surgery, Accessories, Bipolar Forceps

Bipolar coagulation forceps with Sintram tips do not stick to coagulated vessels.

NON STICKING

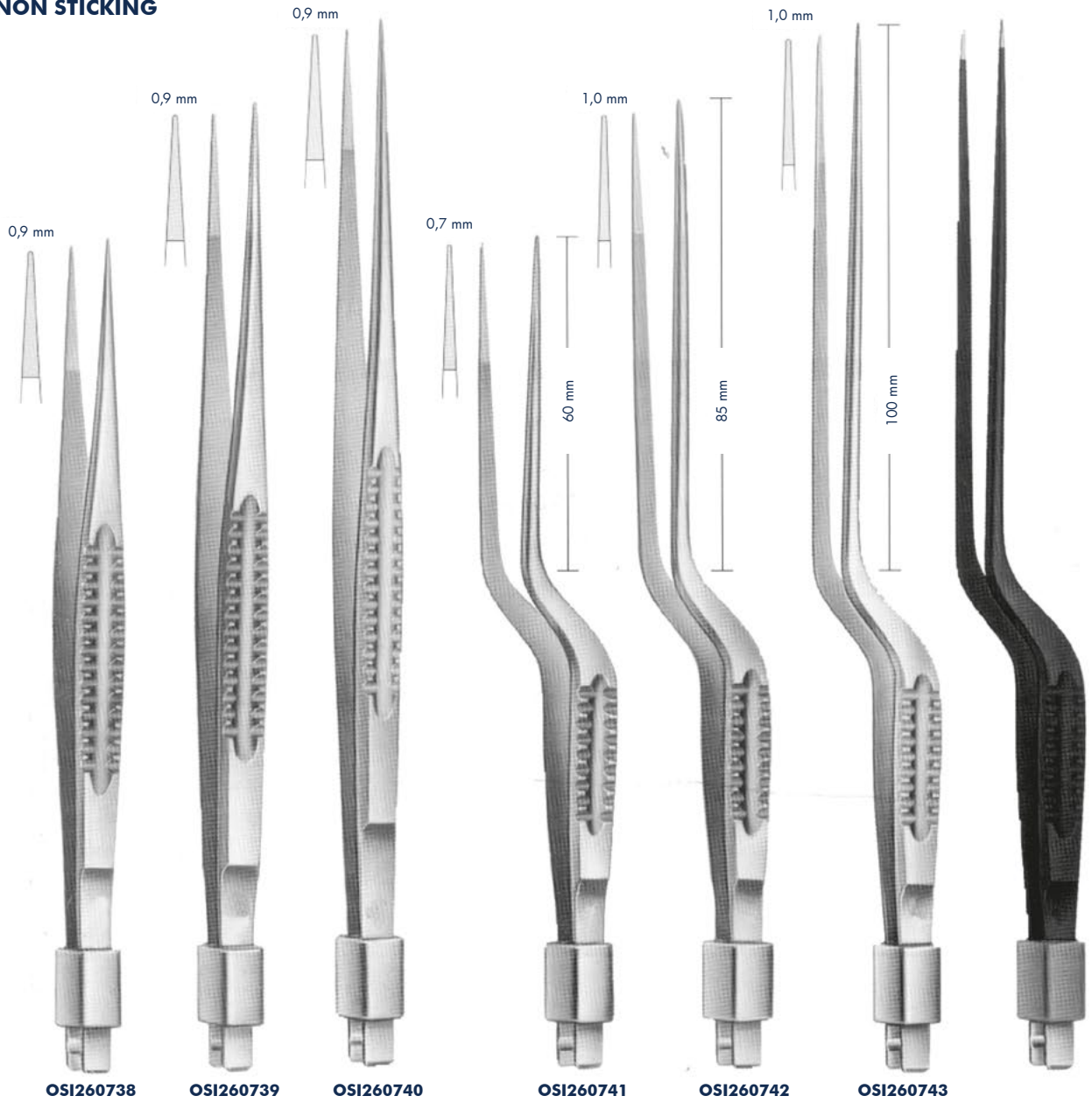

Total length 160 mm

185 mm

200 mm

OSI260746
insulated
160 mm

OSI260747
insulated
185 mm

OSI260748
insulated
200 mm

Micro Scissors, Scalpel Handles

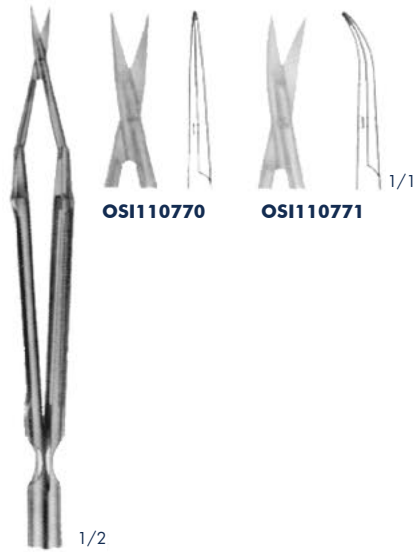

OS110770

OS110771

1/2

BROCK
OS110770 - OS110771

15 cm

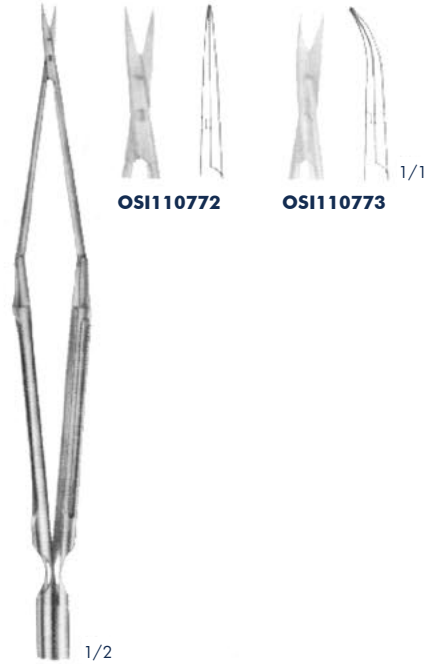

OS110772

OS110773

1/1

1/2

BROCK
OS110772 - OS110773

18 cm



OS1100397

21 cm

OS110774

23 cm

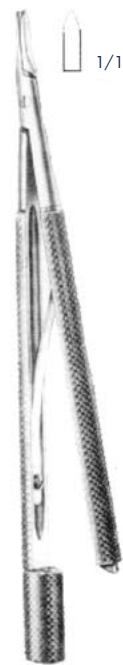

CASTROVIEJO

OS1100398

Ø 8 cm

13 mm

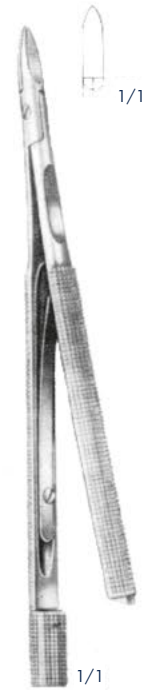

TROUTMAN-CHRIS

OS1100399

Ø 5,5 cm

9 mm

Micro Scissors



1/1



OSI110775 - OSI110782
18 cm
OSI110783 - OSI110790
20 cm

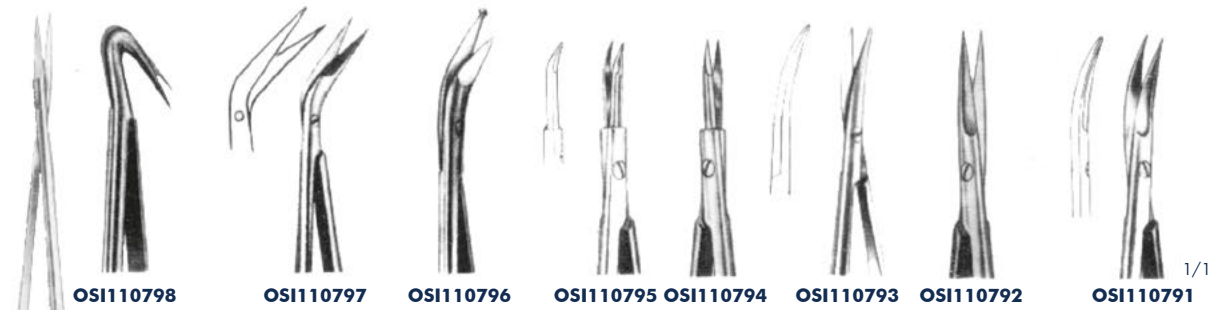

1/1



OSI110791 - OSI110798
22,5 cm

Ligature Forceps

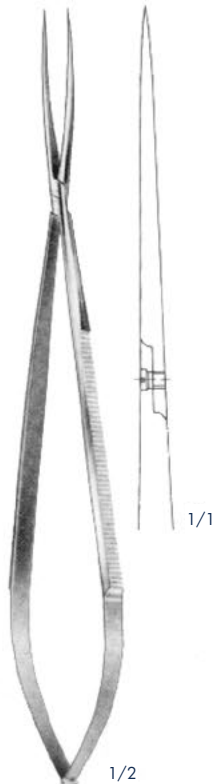

OS1120418
22 cm

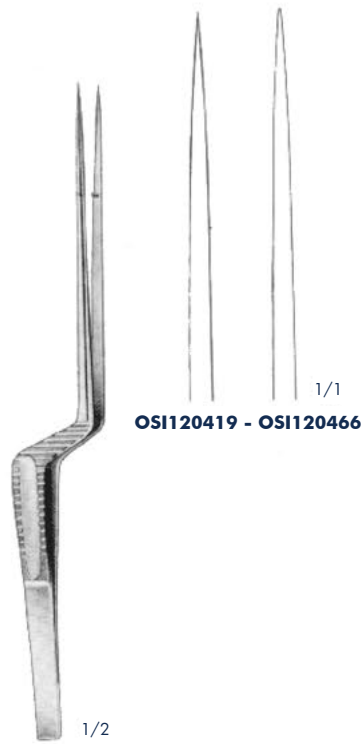

OS1120419 - OS1120466
18,5 cm

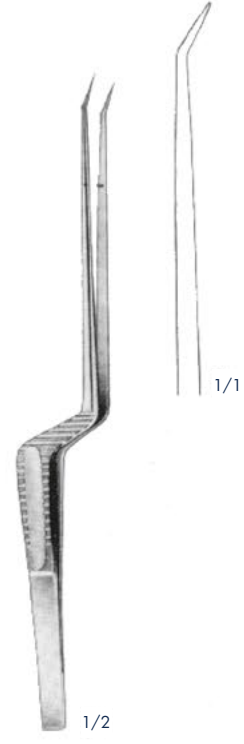

OS1120467
18,5 cm



OS1120430
16 cm



OS1120431
18,5 cm

Micro Needle Holders, Micro Suture Tying Forceps



ARRUGA
OSI170551
13,5 cm



KALT
OSI170552
13,5 cm

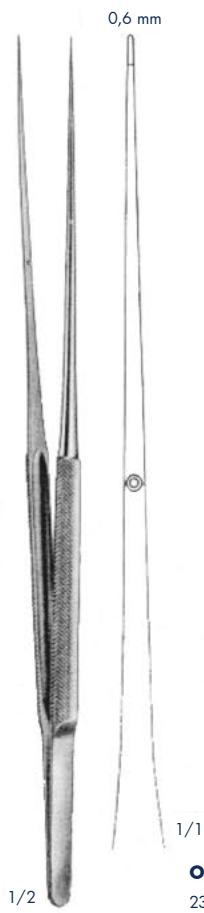

BROCK
OSI120415
23 cm

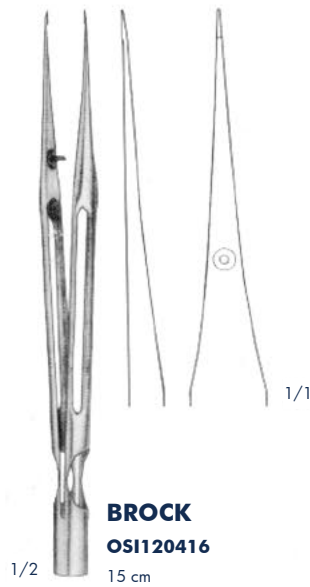

BROCK
OSI120416
15 cm

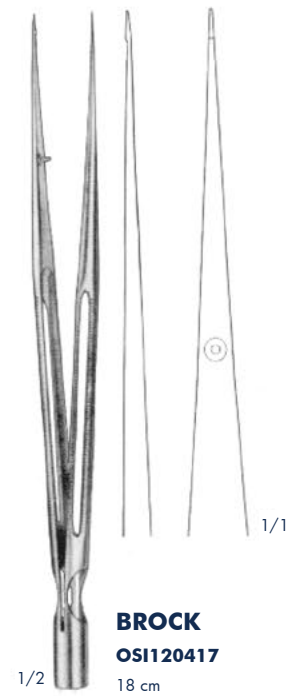

BROCK
OSI120417
18 cm

Micro Needle Holders



BROCK
OSI170554 - OSI170555
15 cm



BROCK
OSI170556 - OSI170557
18 cm



MULLER
OSI170558
14,5 cm

Self - Retaining Retractors

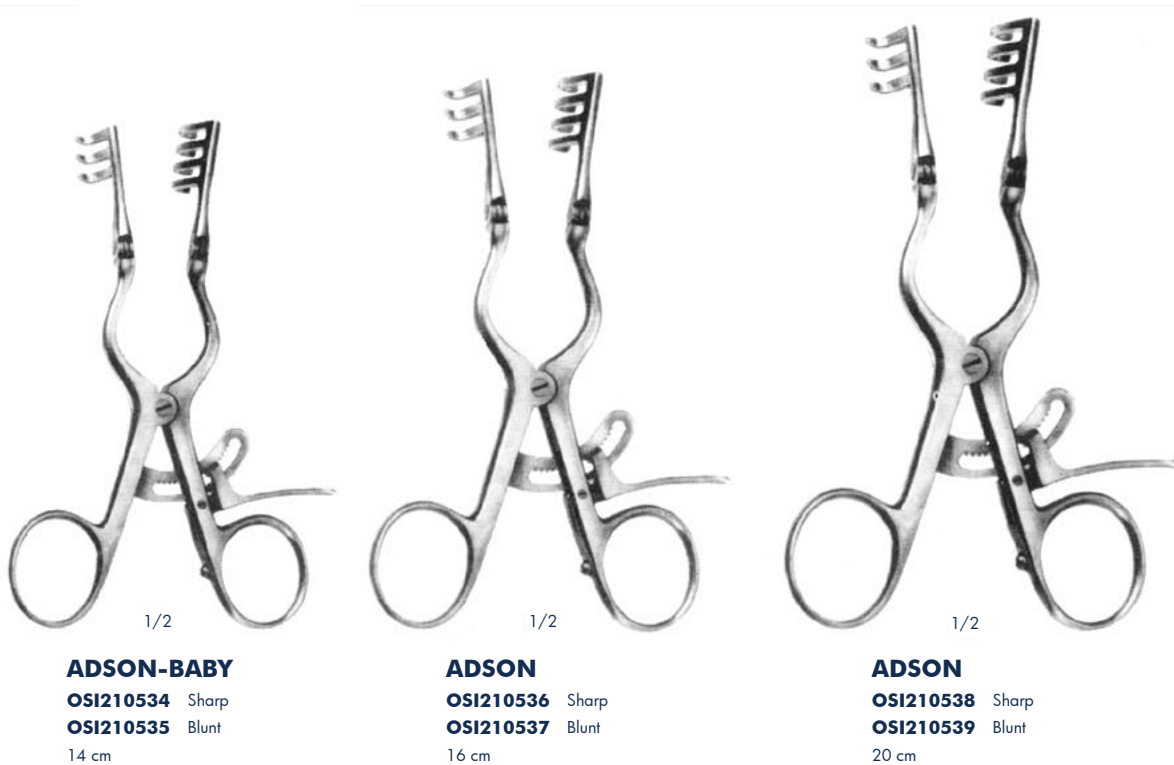
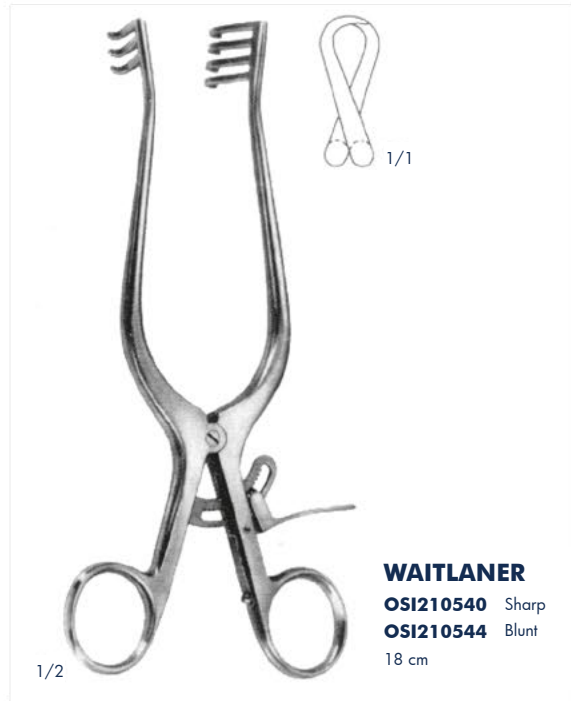

Self - Retaining Retractors



1/2

MEYERDING
OSI210552 - OSI210557
 Right Blade
 18 cm

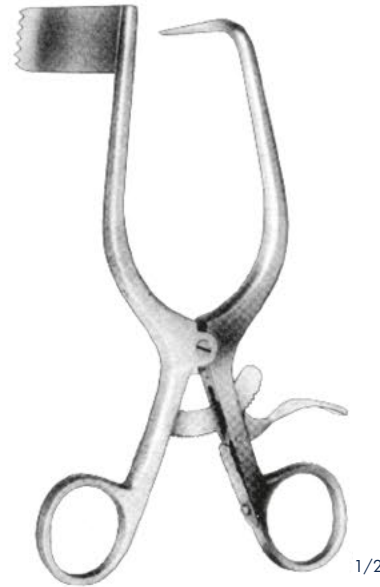

1/2

MEYERDING
OSI210546 - OSI210551
 Left Blade
 18 cm

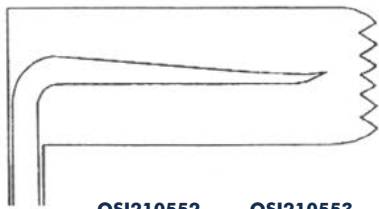

OSI210552
 Left Blade

OSI210553
 Right Blade

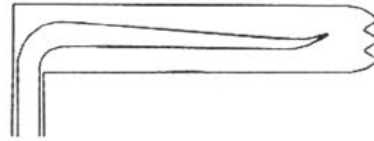

OSI210546
 Left Blade

OSI210547
 Right Blade

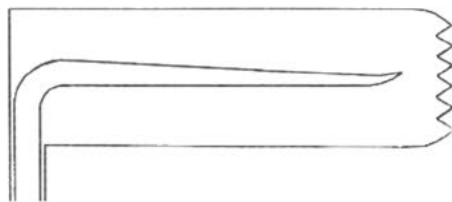

OSI210554
 Left Blade

OSI210555
 Right Blade

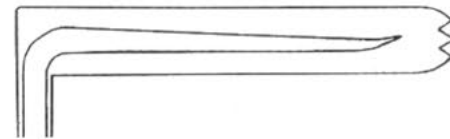

OSI210548
 Left Blade

OSI210549
 Right Blade

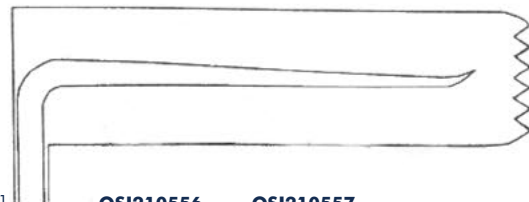

1/1

OSI210556
 Left Blade

OSI210557
 Right Blade

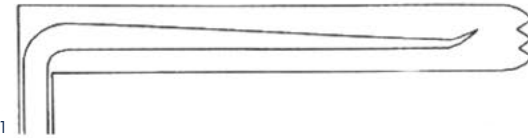

1/1

OSI210550
 Left Blade

OSI210551
 Right Blade

Self - Retaining Retractors



DARLING
OSI210558
18 cm



DARLING
OSI210559
18 cm

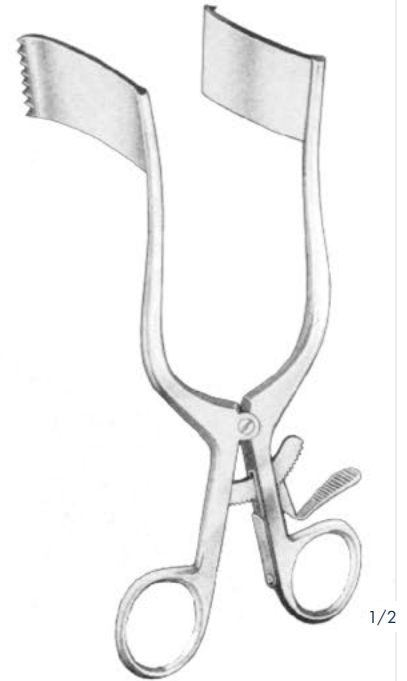

DARLING
OSI210560 25 x 40 mm
OSI210561 25 x 50 mm
OSI210562 25 x 60 mm
17 cm



OSI210563
17 cm



OSI210564 Right
18 cm



OSI210565 Left
18 cm

Self - Retaining Retractors

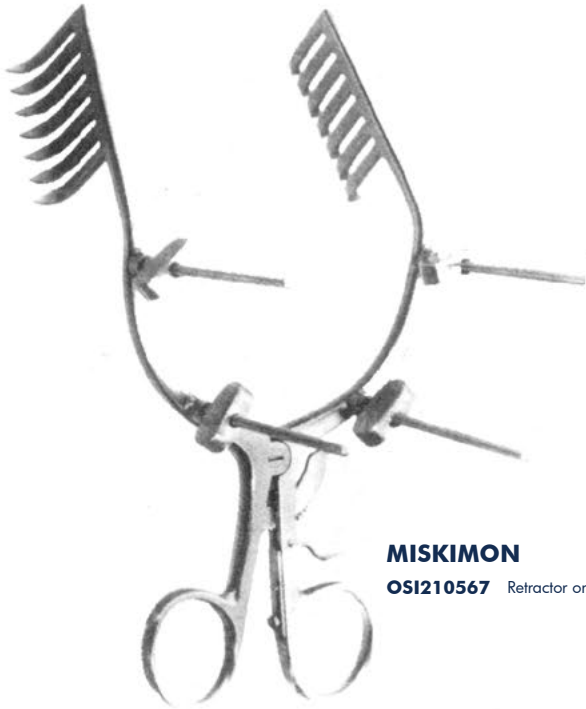

MISKIMON
OSI210567 Retractor only



MISKIMON
OSI210568 10 x 100 mm
OSI210569 15 x 76 mm
OSI210570 17 x 76 mm
OSI210571 20 x 100 mm
OSI210572 25 x 76 mm



MISKIMON
OSI210573



MISKIMON
OSI210574

MISKIMON
OSI210566 Complete
OSI210568 - OSI210572 1 each
OSI210573 x 4 each
OSI210574 x 4 each

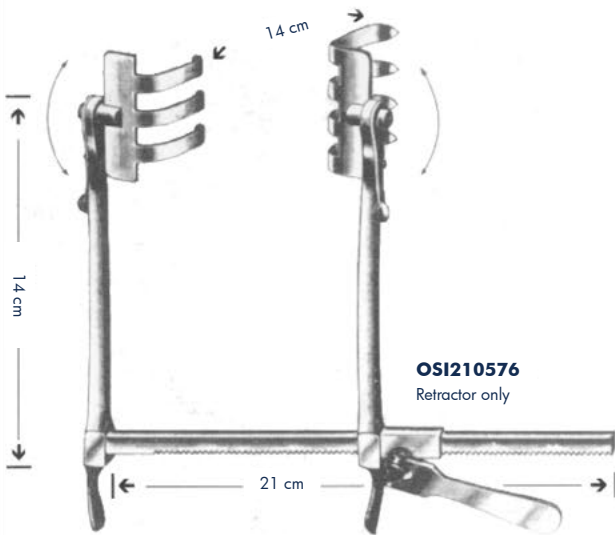

SCOVILLE-RICHTER
OSI210575 Complete
(OSI210577 - OSI210586)



OSI210577 48 mm
OSI210578 60 mm



OSI210579 48 x 30 mm
OSI210580 60 x 30 mm



OSI210581 48 x 50 mm
OSI210582 60 x 50 mm



OSI210583 48 x 50 mm
OSI210584 60 x 50 mm



OSI210585 38 x 62 mm



OSI210586 28 x 40 mm

OSI210576
Retractor only

Self - Retaining Retractors



Self - Retaining Retractors

TAYLOR-TURANTAN

OSI210594

20 x 68 x 150 mm

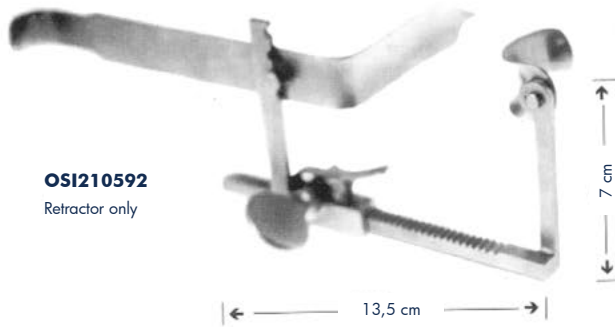

OSI210592
Retractor only

TURANTAN

OSI210593 Complete

OSI210594 - OSI210595 - OSI210596 - OSI210597

OSI210595 20 x 20 mm

OSI210596 30 x 20 mm

OSI210597 36 x 20 mm

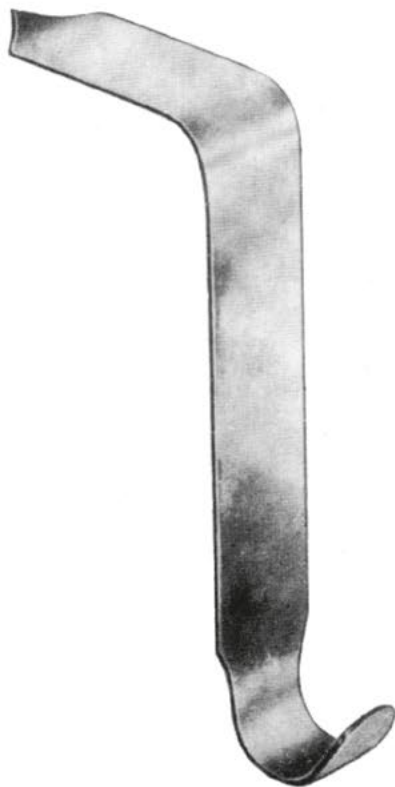

TAYLOR

OSI210598 32 x 75 x 185 mm

OSI210599 32 x 100 x 200 mm



BALLANTINE

OSI210602

23 cm

32 x 90 mm

Retractors for Cervical Spine, Bookwalter Abdominal Retractors



BOOKWALTER-KELLY

- OSI210607 51 x 75 mm
- OSI210608 53 x 102 mm
- OSI210609 53 x 127 mm
- OSI210667 53 x 150 mm

BOOKWALTER-BELFOUR

- OSI210636 65 x 75 mm

BOOKWALTER

OSI210650

BOOKWALTER

OSI210647

BOOKWALTER

OSI210668 - OSI210669

BOOKWALTER

- OSI210640 51 x 64 mm
- OSI210641 64 x 76 mm

BOOKWALTER-HERRINGTON

- OSI210670 40 x 145 mm
- OSI210635 65 x 145 mm

BOOKWALTER

- OSI210657 Ø 200 x 310 mm
- OSI210658 Ø 265 x 370 mm
- OSI210659 Ø 265 x 470 mm

BOOKWALTER

OSI210645

43 cm

Bookwalter Abdominal Retractors



2,5 cm

BOOKWALTER
OSI210646



BOOKWALTER
OSI210647

36,5 cm



BOOKWALTER
OSI210648

360° flex bar



BOOKWALTER
OSI210649

30,5 cm



BOOKWALTER
OSI210650



BOOKWALTER
OSI210668



BOOKWALTER
OSI210669

Bookwalter Abdominal Retractors

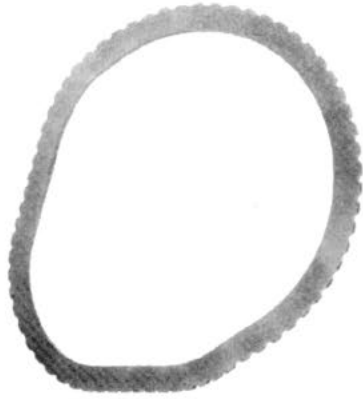

BOOKWALTER
OSI210653
200 x 265 mm

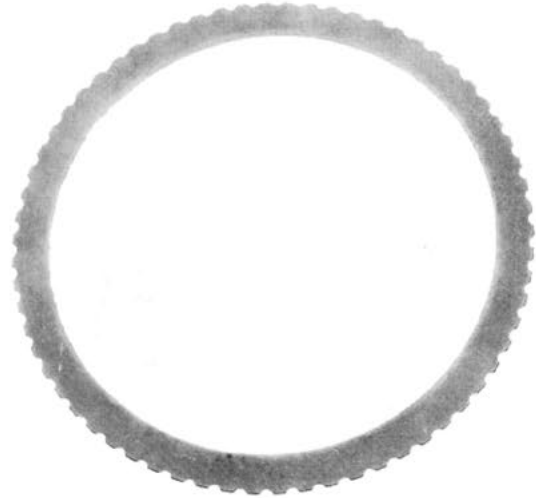

BOOKWALTER
OSI210654 Ø 215 mm
OSI210655 Ø 265 mm
OSI210656 Ø 315 mm



BOOKWALTER
OSI210657 Ø 200 x 310 mm
OSI210658 Ø 265 x 370 mm
OSI210659 Ø 265 x 470 mm



BOOKWALTER
OSI210660 Ø 215 x 255 mm
OSI210661 Ø 265 x 495 mm
OSI210662 Ø 315 x 495 mm

Bookwalter Abdominal Retractors



BOOKWALTER BELFOUR
OSI210636 65 x 75 mm

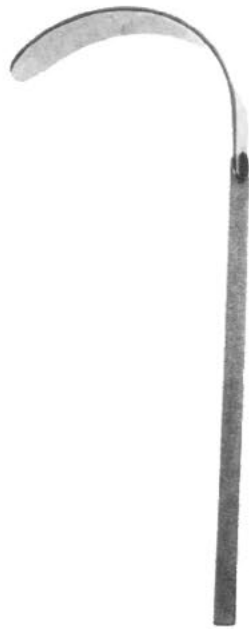

MAGRINE BOOKWALTER
OSI210664 25 x 90 mm
OSI210665 25 x 130 mm



BOOKWALTER HERRINGTON
OSI210670 40 x 145 mm
OSI210635 65 x 145 mm

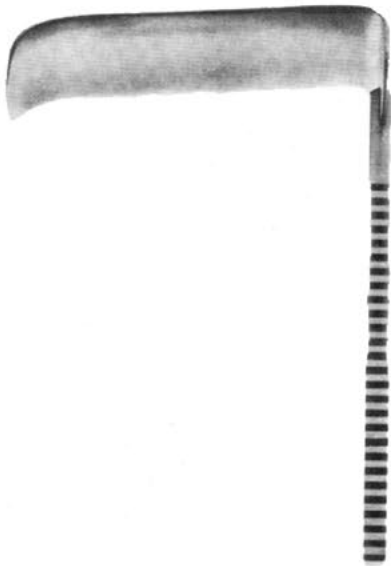

BOOKWALTER-KELLY
OSI210607 51 x 75 mm
OSI210608 53 x 102 mm
OSI210609 53 x 127 mm
OSI210667 53 x 150 mm



BOOKWALTER-KELLY
OSI210640 51 x 64 mm
OSI210641 64 x 76 mm



MAGRINE BOOKWALTER
OSI210678 25 x 75 mm



BOOKWALTER
OSI210679 25 x 115 mm

Bookwalter Abdominal Retractors

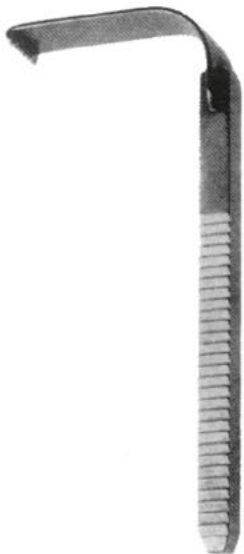

BOOKWALTER-MEYERDING
OSI210680 17 x 60 mm

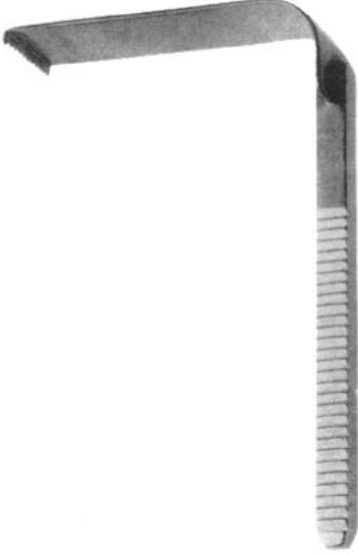

BOOKWALTER-MEYERDING
OSI210681 25 x 85 mm

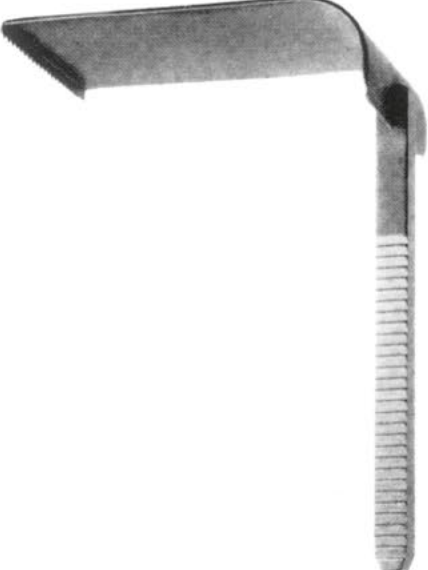

BOOKWALTER-MEYERDING
OSI210682 50 x 95 mm

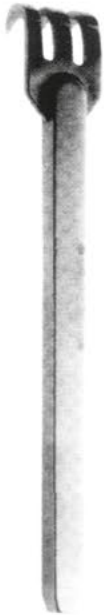

BOOKWALTER
OSI210683 17 x 20 mm



BOOKWALTER
OSI210684 20 x 8,5 mm



BOOKWALTER
OSI210685 25 x 8,5 mm

Bookwalter Abdominal Retractors

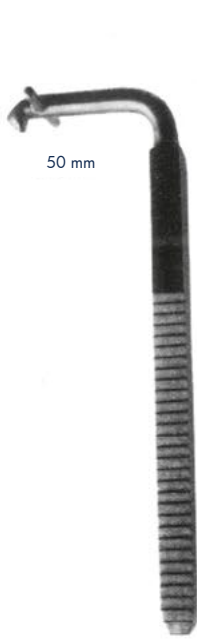

SCOVILLE-BOOKWALTER
OSI210686



SCOVILLE-BOOKWALTER
OSI210687

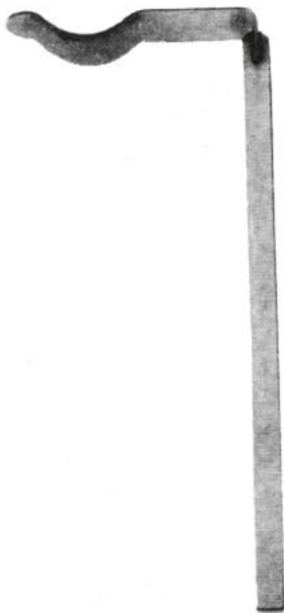

BOOKWALTER
OSI210688 75 mm
OSI210689 100 mm



BOOKWALTER
OSI210690 50 mm
OSI210691 40 mm
OSI210692 75 mm



BOOKWALTER
OSI210693

Rectal Specula, Biopsy Forceps

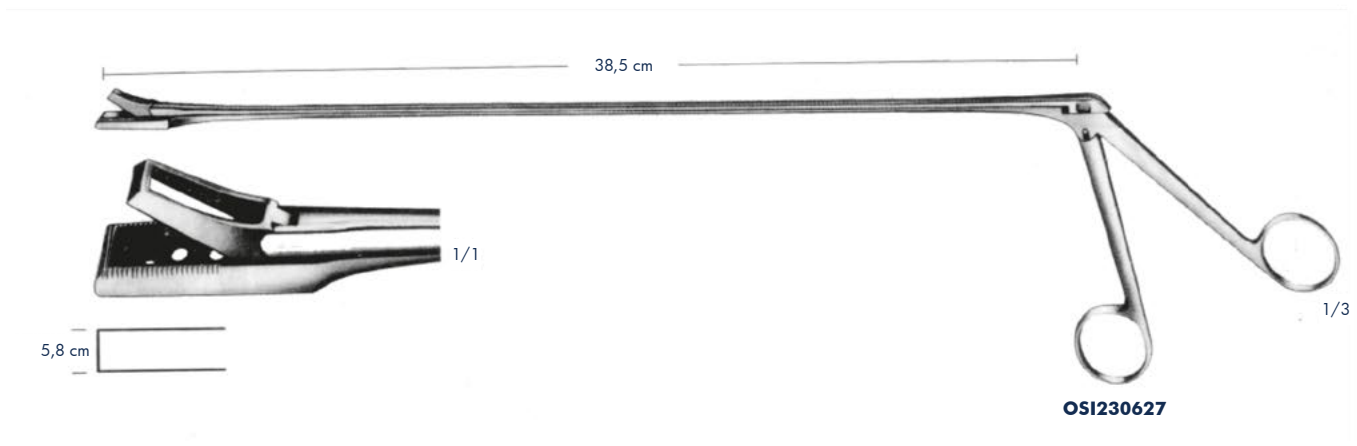
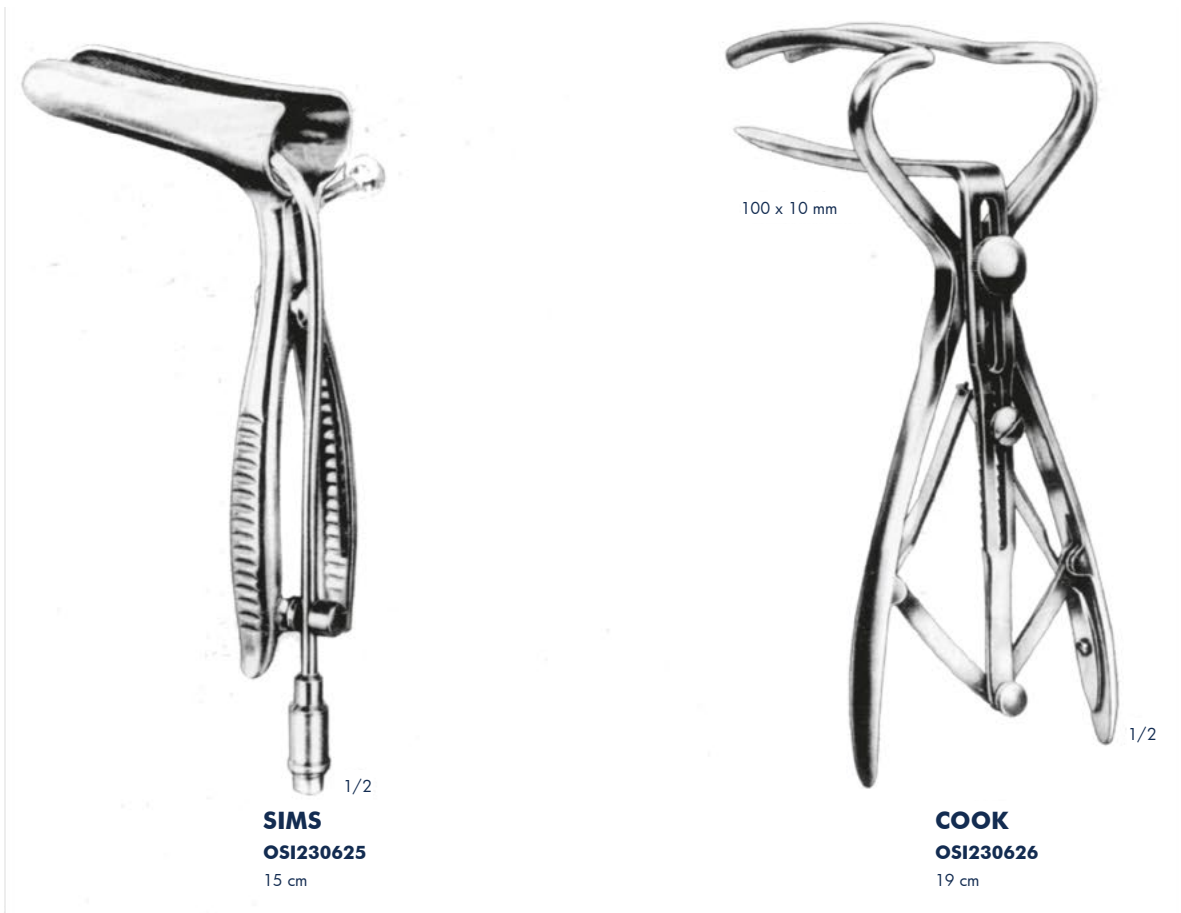

TUBB
OSI180
230 mm
Set, const
45°
Ø 4,5 mm

Biopsy Forceps

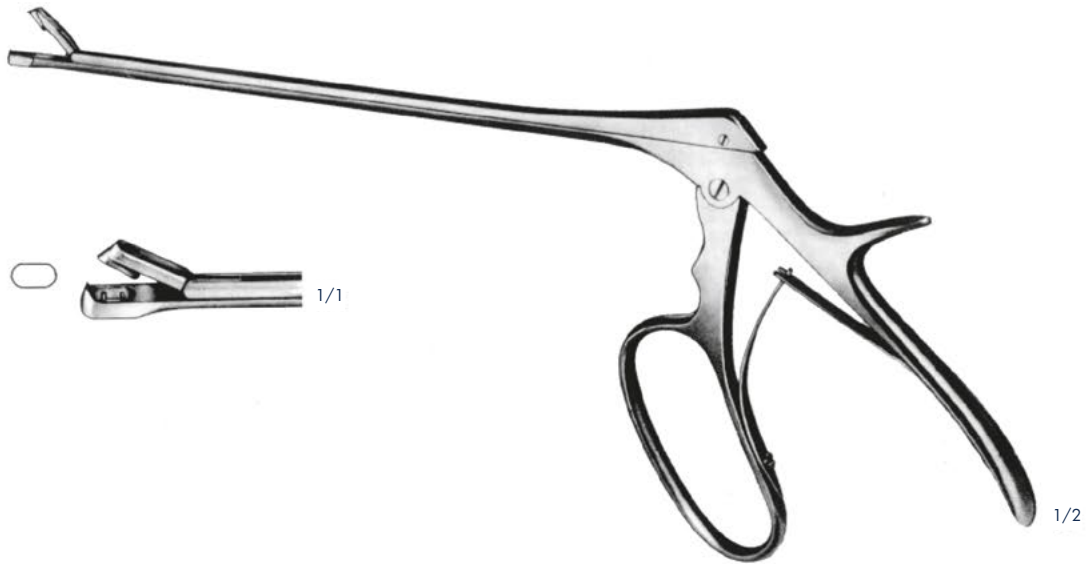

TISCHLER

OSI230628 20 cm

OSI230629 24 cm

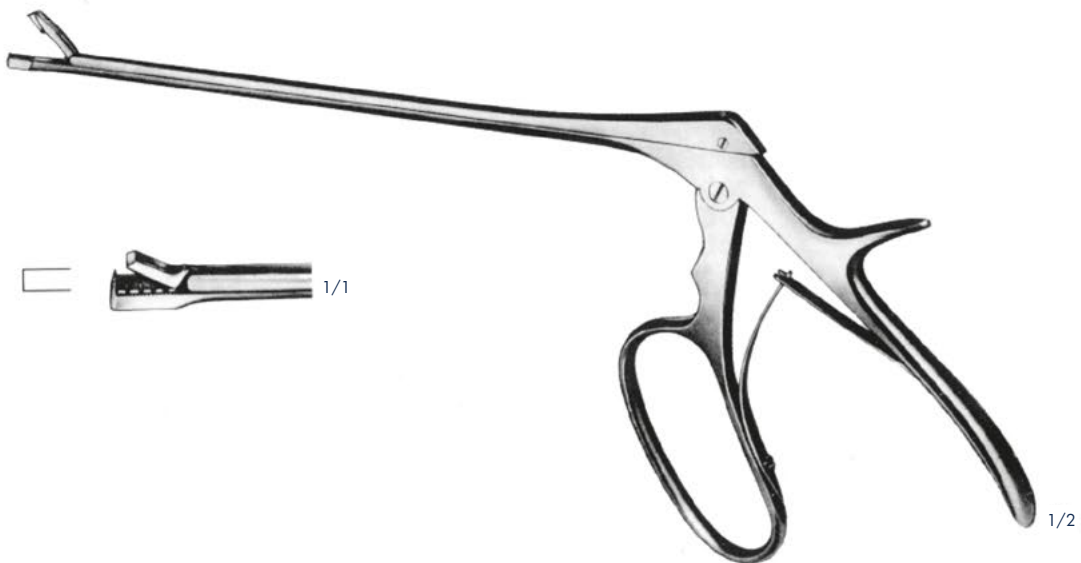

KEVORKIAN

OSI230630 20 cm

OSI230631 24 cm

S
285

isting of:

m

Self - Retaining Retractors

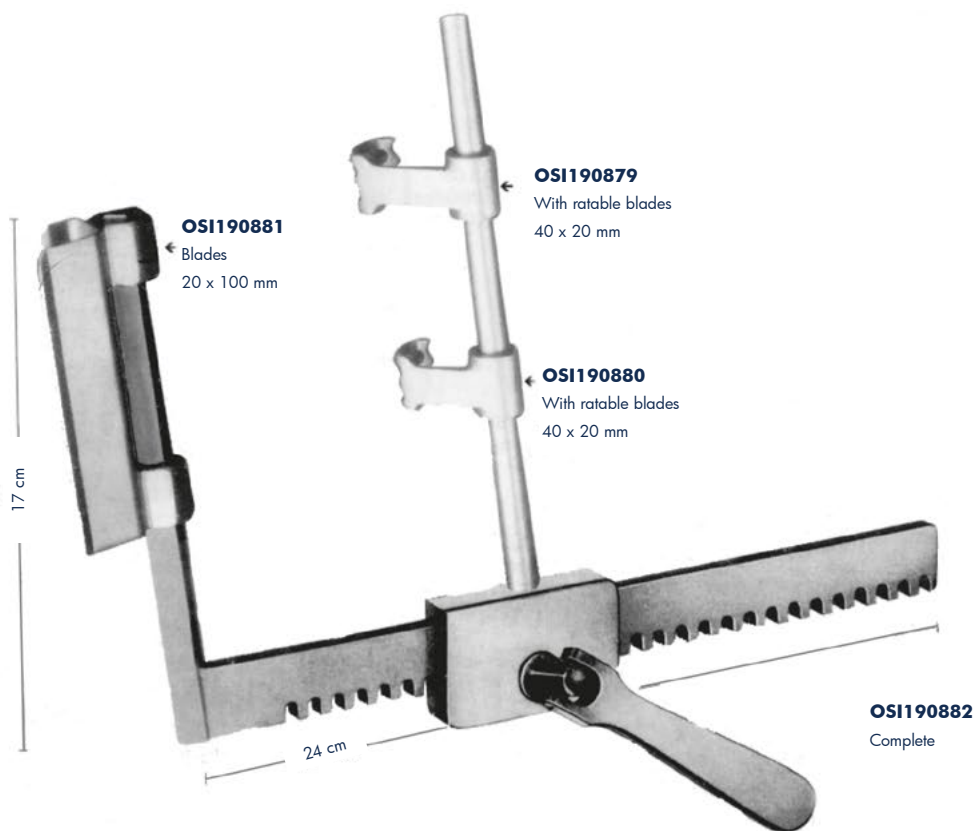
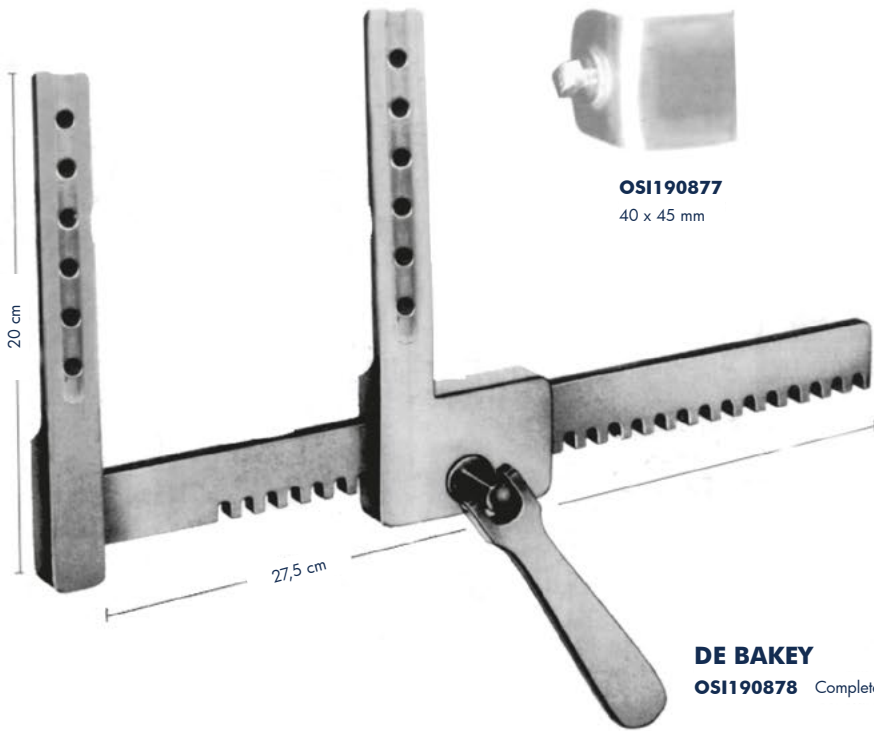

Raspatories

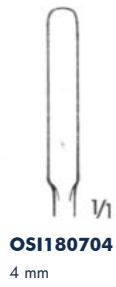

COBB
OSI180704 - OSI180706
27 cm



COBB
OSI180707 - OSI180709
28 cm

Osteotomes Gouges



Osteotomes

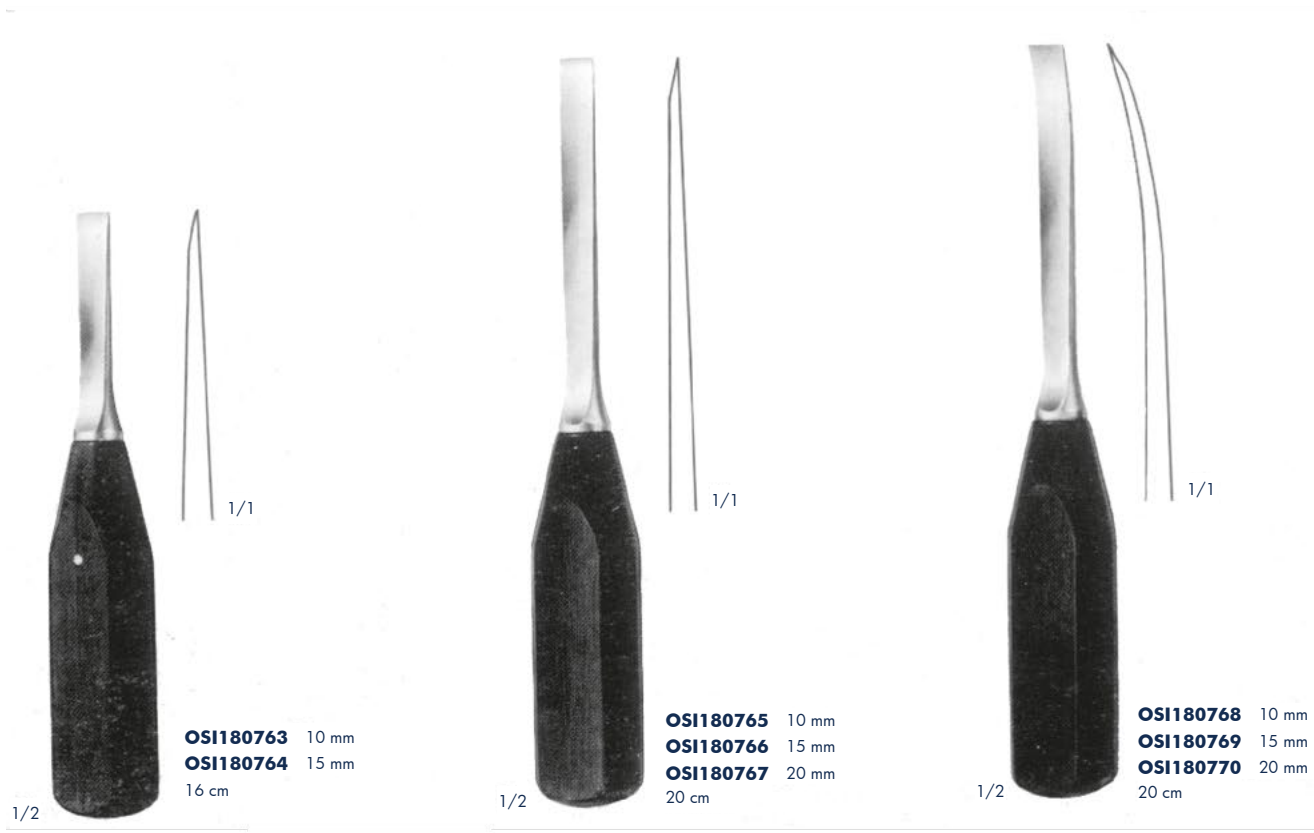

Gouges

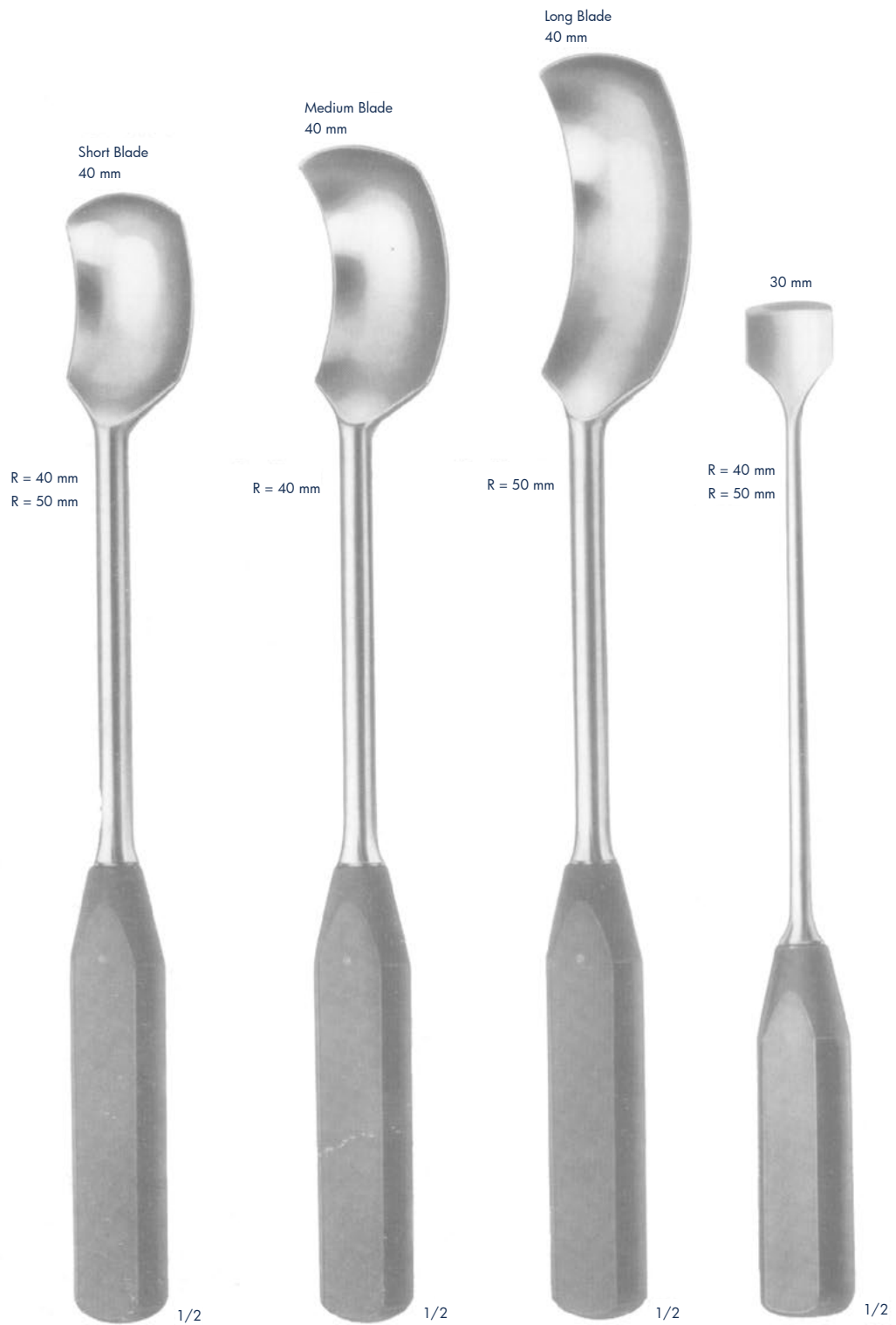

WAGNER
OSI180771

WAGNER
OSI180773

WAGNER

WAGNER
OSI180775

Radius 40 mm

40 cm

37 cm

40 cm

2 cm

Radius 50 mm

OSI180282

OSI180774

OSI180776

Gouges

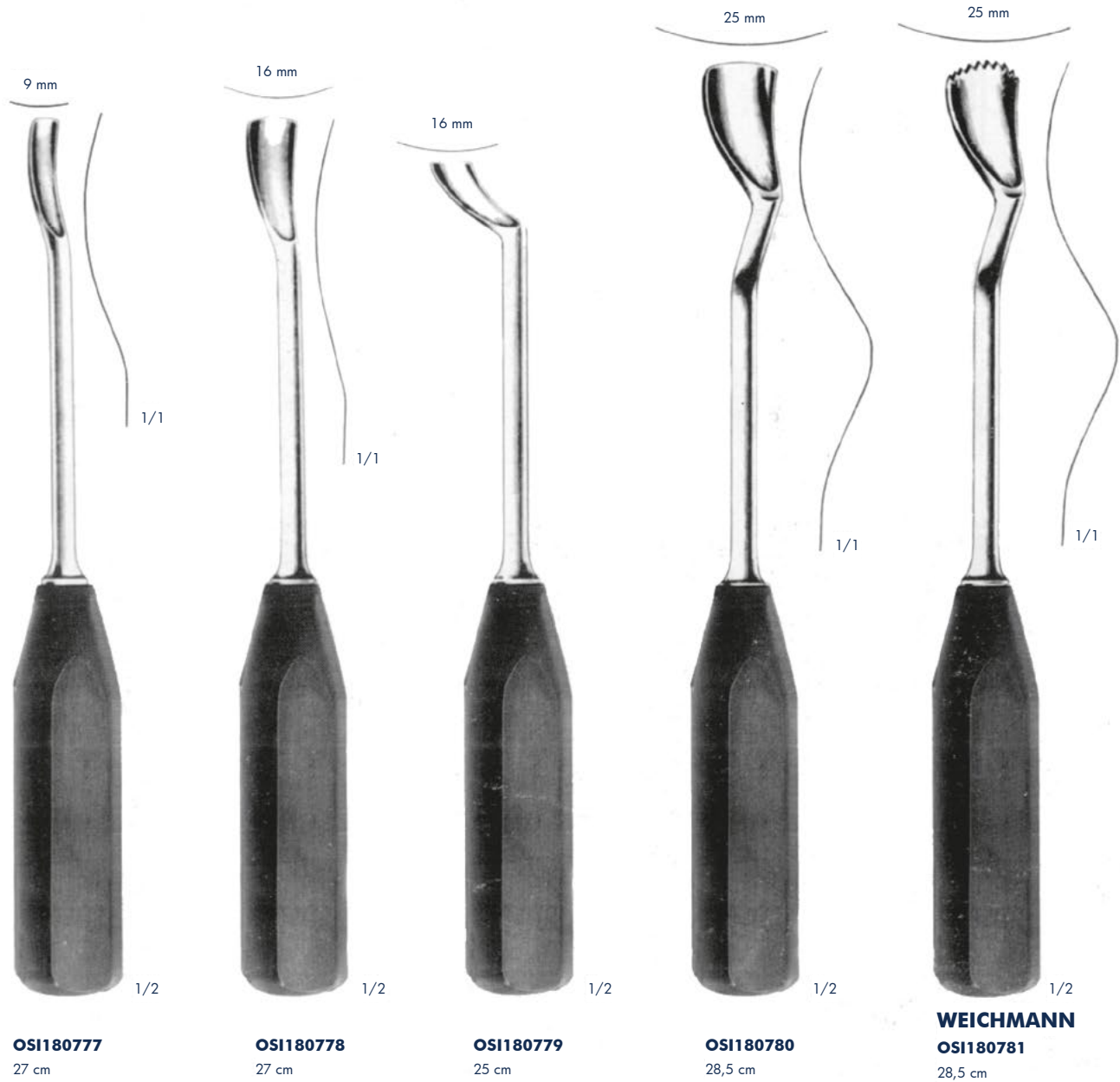

OSI180777
27 cm

OSI180778
27 cm

OSI180779
25 cm

OSI180780
28,5 cm

WEICHMANN
OSI180781
28,5 cm

Gouges



COBB
OSI180782
28 cm



COBB
OSI180783
28 cm









































COBB
OSI180784
28 cm



COBB
OSI180785
28 cm

Bone Currettes

			
OSI190883 3,0 mm	OSI190892 3,0 mm	OSI190902 3,0 mm	
			
OSI190884 3,6 mm	OSI190893 3,6 mm	OSI190903 3,6 mm	
			
OSI190885 4,2 mm	OSI190894 4,2 mm	OSI190904 4,2 mm	
			
OSI190886 5,0 mm	OSI190895 5,0 mm	OSI190905 5,0 mm	
			
OSI190887 6,2 mm			
	OSI190896 6,2 mm	OSI190906 6,2 mm	
			
OSI190888 7,0 mm	OSI190897 7,0 mm	OSI190907 7,0 mm	
			
OSI190889 8,2 mm	OSI190898 8,2 mm	OSI190910 8,2 mm	
			
OSI190890 9,0 mm	OSI190899 9,0 mm	OSI190911 9,0 mm	
			
OSI190891 10,5 mm	OSI190901 10,5 mm	OSI190912 10,5 mm	
			OSI190913 3,6 mm
			OSI190914 4,5 mm
			OSI190915 5,2 mm
 1/2	 1/2	 1/2	 1/2
SPINAL OSI90883 - OSI190891 23 cm	SPINAL OSI90892 - OSI190901 28 cm	COBB OSI90902 - OSI190912 28 cm	SIMON OSI90913 - OSI190915 23,5 cm

Bone Curettes

OSI190916
 Ø 4 mm

OSI190917
 Ø 5 mm

OSI190918
 Ø 6 mm

1/1

1/2

KRAMER
OSI190916 - OSI190918
 Çift taraflı / Double sided
 25 cm

OSI190946
 14,5 mm

OSI190947
 14,5 mm

OSI190948
 11,5 mm

OSI190949
 10 mm

OSI190951
 8,5 mm

OSI190952
 6,8 mm

1/1

1/2

SCHRÖDER
OSI190946 - OSI190952
 31 cm

OSI190953
 14 mm

OSI190954
 12 mm

OSI190955
 10 mm

OSI190956
 8 mm

OSI190957
 6 mm

1/1

1/2

GOURDET
OSI190953 - OSI190957
 Blunt
 28 cm

Bone Curettes

SEMMES
OSI190919 4 x 7 mm
 Straight
 23 cm

SEMMES
OSI190920 4 x 7 mm
 Slightly curved
 23 cm

SEMMES
OSI1909221 4 x 7 mm
 Full curved
 23 cm

CONE
OSI1909222 Ø 3 mm
OSI1909223 Ø 6 mm
OSI1909224 Ø 8 mm
 Straight
 23 cm

CONE
OSI1909225 - OSI190927
 Curved
 23 cm

OSI190925
 Ø 3 mm

OSI190926
 Ø 6 mm

OSI190927
 Ø 8 mm

Bone Curettes

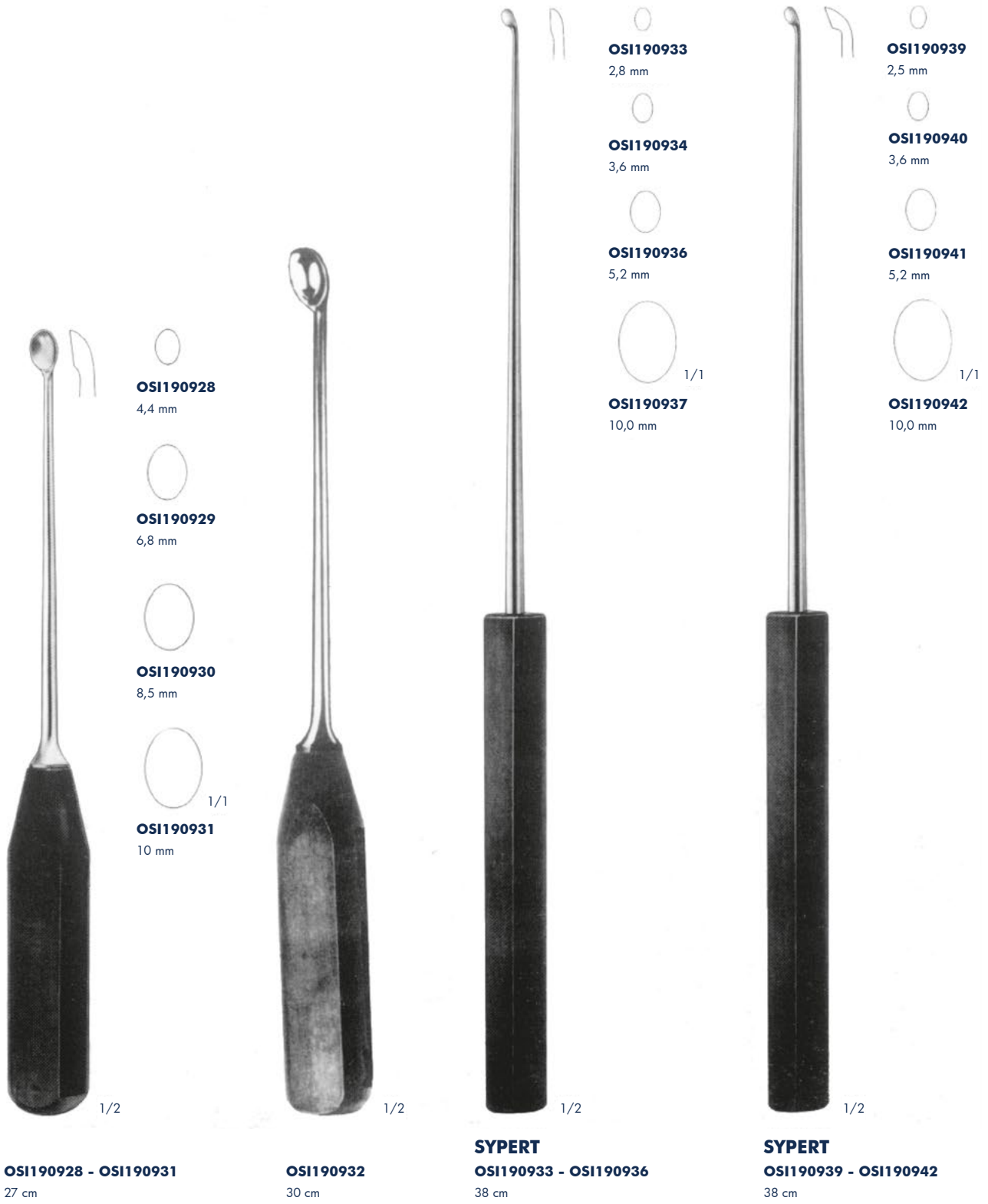

Bone Curettes



1/2

SYPERT
OS1190943 - OS1190944
42,5 cm



1/2

SYPERT
OS1190945
42,5 cm

Punches, Rongeurs

350° turnable



CASPAR
OSI290698 4 mm



Punches

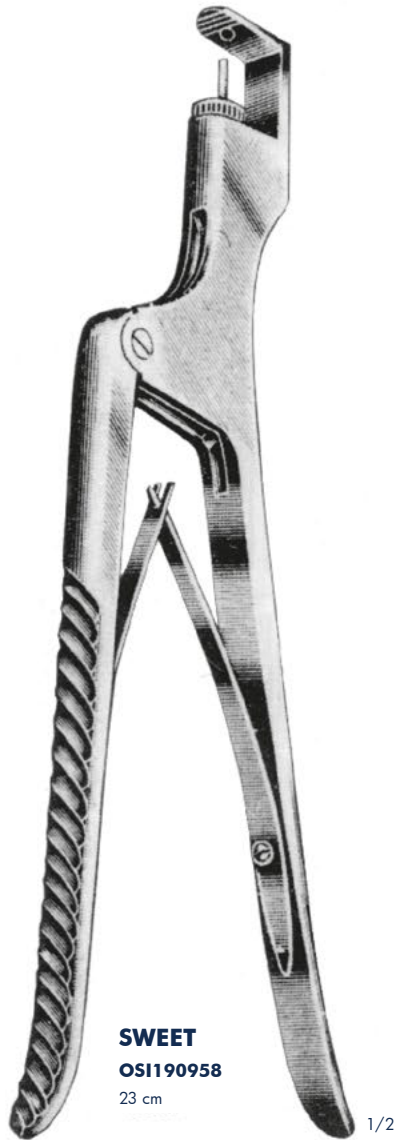

Clip Applying Forceps

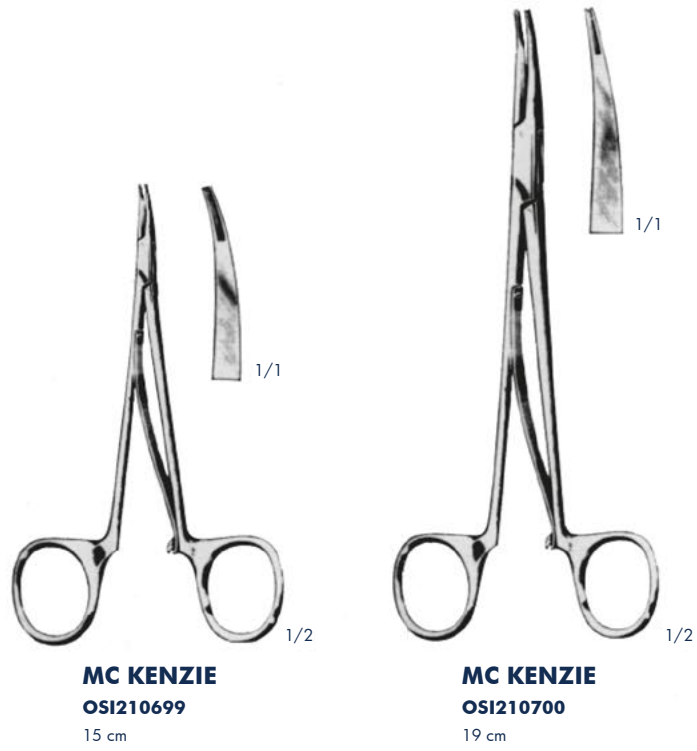

Spring Hooks



Combined Retractors and Handrest System



GILBACH
OSI210706 Bacc unit



Table fixation attachment
OSI210707



Table fixation attachment



Holding device for skull clamp **OSI210708**



Holding device for skull clamp **OSI210709**

Combined Retractors and Handrest System



OSI210710
Holder for forceps

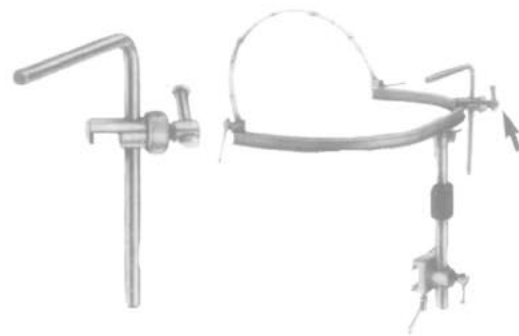

OSI210711
Handrest bar

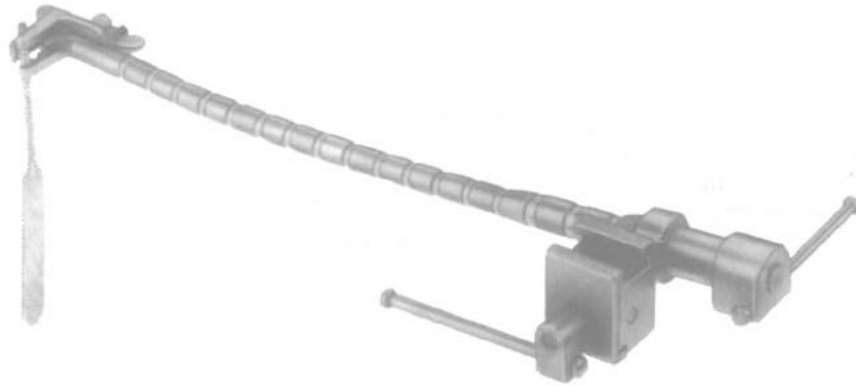
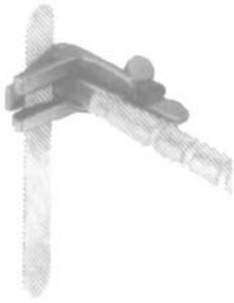

OSI210712
Support only

OSI210713
Flexible arm

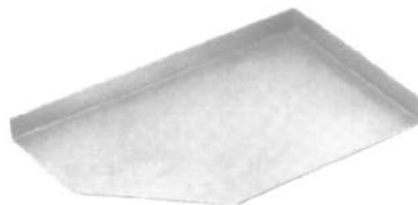

OSI210715
Tray for instruments

OSI210714
Support only



OSI210716
Chain hook

OSI210717
Spring hook

Skull - Clamps

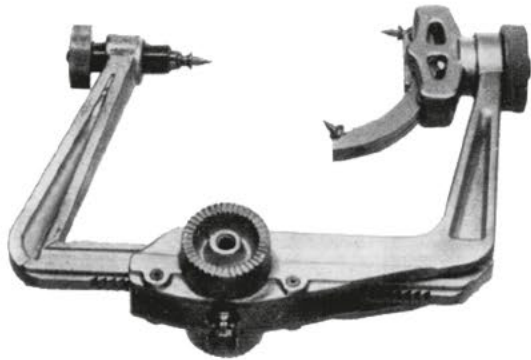

MAYFIELD
OSI210718
Skull clamp



MAYFIELD
OSI210719
Adult size



MAYFIELD
OSI210720
Child size



Set for fixing skull clamp
MAYFIELD
OSI210724 Complete
Skull clamp **OSI210718**
Table fixation attachment **OSI210722**
Table fixation attachment **OSI210721**
Table adaptor **OSI210723**

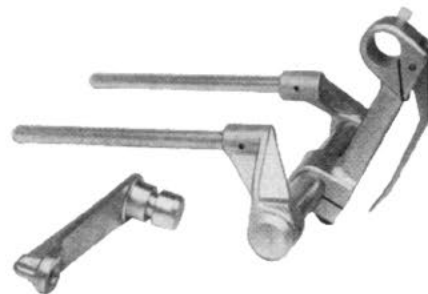

MAYFIELD
OSI210721
Table fixation attachment

MAYFIELD
OSI210722
Table fixation attachment

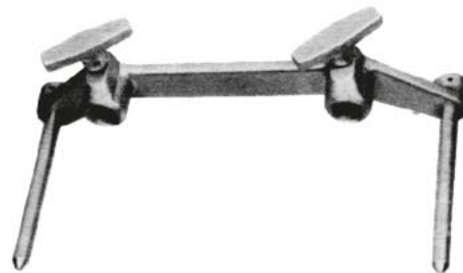

SHAMPAINNE
OSI210723
Table adaptor

TUBB
OSI180
230 mm
Set, consi
45°
Ø 4,5 mm

Skull - Clamps

S
285

isting of:

m

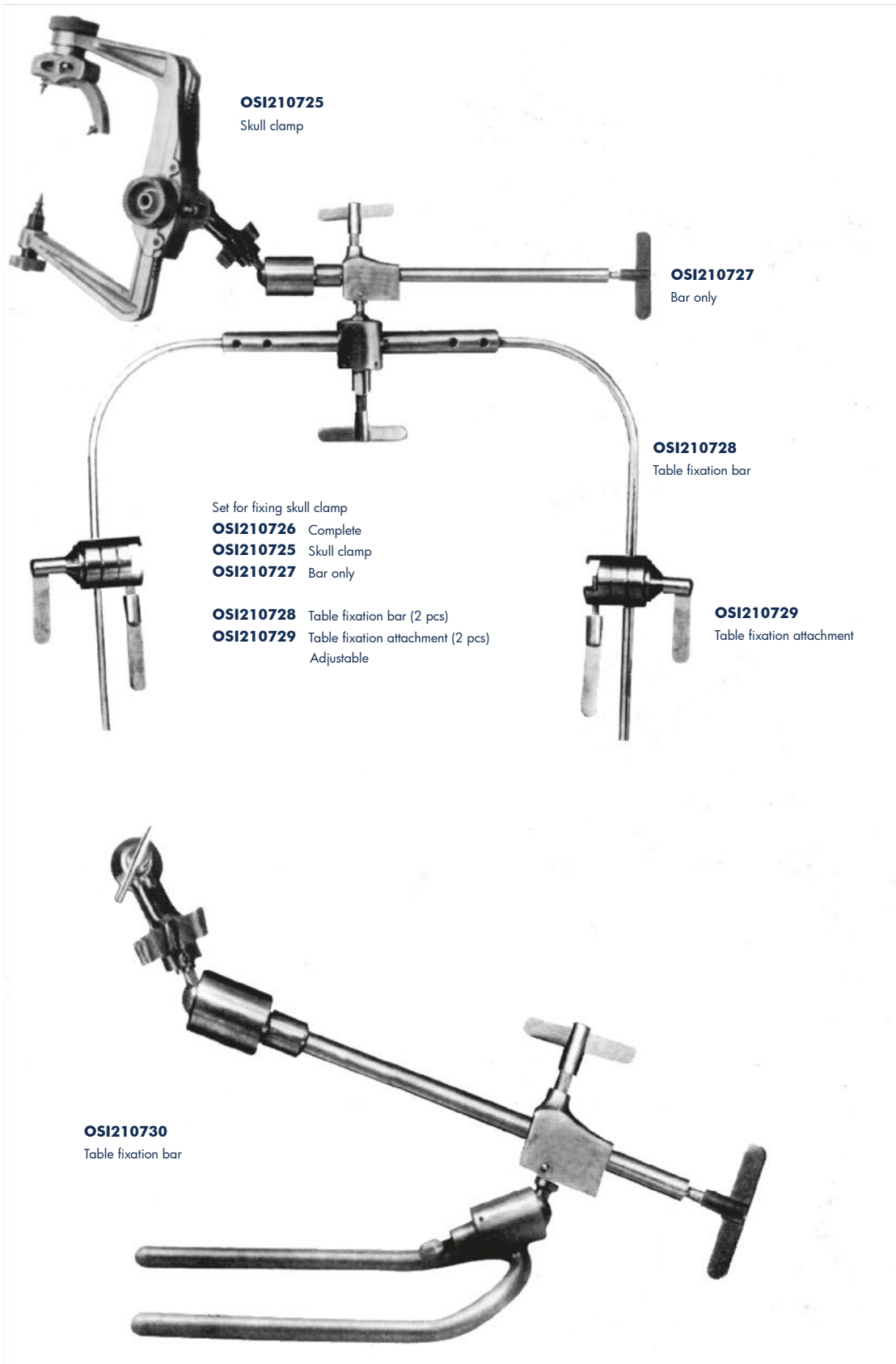

OSI210725
Skull clamp

OSI210727
Bar only

OSI210728
Table fixation bar

Set for fixing skull clamp

OSI210726 Complete

OSI210725 Skull clamp

OSI210727 Bar only

OSI210728 Table fixation bar (2 pcs)

OSI210729 Table fixation attachment (2 pcs)
Adjustable

OSI210729
Table fixation attachment

OSI210730
Table fixation bar

Instruments for Hypophysectomy, Transanal Instruments

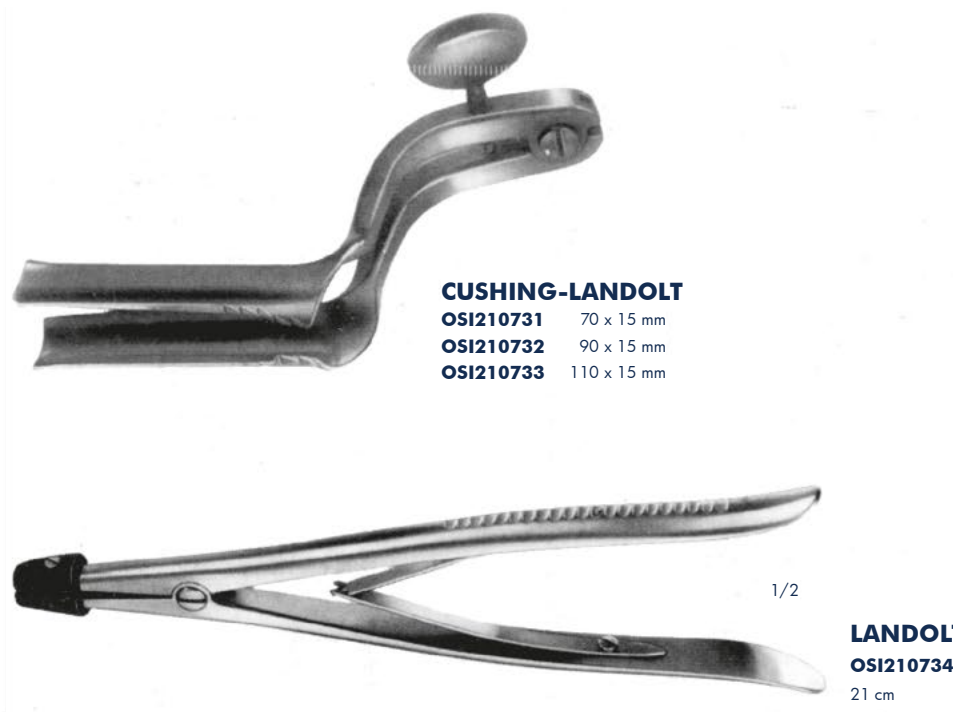

CUSHING-LANDOLT

OSI210731 70 x 15 mm

OSI210732 90 x 15 mm

OSI210733 110 x 15 mm

1/2

LANDOLT

OSI210734

21 cm



CROCKARD

OSI210735

Total length 11 cm

Tip with 25 mm

Hard palate
retractor



CROCKARD

OSI210736 Small size

18 cm

OSI210737 Large size

19 cm

Cloward Instruments



CLOWARD
OSI210738 18 mm
OSI210739 20 mm
OSI210740 23 mm
 18 cm



CLOWARD
OSI210741
 20 x 12 mm
 20 cm



CLOWARD
OSI210742
 10 x 8 mm
 19 cm



CLOWARD
OSI210743
 Coutery hook
 20 cm



CLOWARD
OSI210744 5 cm
OSI210745 8 cm
OSI210746 10 cm
 20 cm



CLOWARD
OSI210747
 20 cm



CLOWARD
OSI210748
 18 cm

Cloward Instruments



CLOWARD

OSI210749

Dowel cutter shaft
16,5 cm

OSI210750-OSI210753

Dowel cutters

OSI210754-OSI210757

Dowel center pins

OSI210758

Dowel ejector

OSI210759-OSI210762

Dowel holders

OSI210763

Dowel handle

OSI210764

Wrench

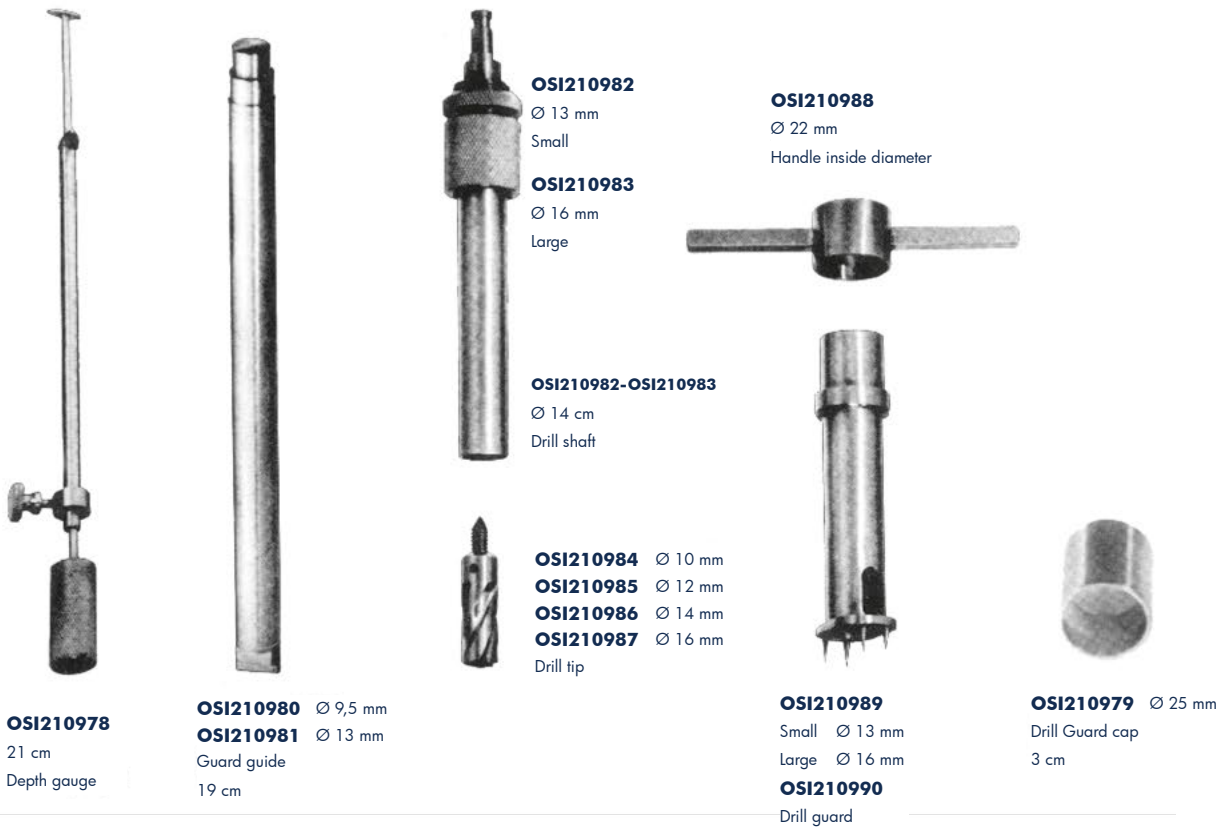

OSI210978

21 cm
Depth gauge

OSI210980 Ø 9,5 mm

OSI210981 Ø 13 mm

Guard guide
19 cm

OSI210982

Ø 13 mm
Small

OSI210983

Ø 16 mm
Large

OSI210982-OSI210983

Ø 14 cm
Drill shaft

OSI210984 Ø 10 mm

OSI210985 Ø 12 mm

OSI210986 Ø 14 mm

OSI210987 Ø 16 mm

Drill tip

OSI210988

Ø 22 mm
Handle inside diameter

OSI210989

Small Ø 13 mm

Large Ø 16 mm

OSI210990

Drill guard

OSI210979 Ø 25 mm

Drill Guard cap
3 cm

Cerclage Instruments Screw and Plate Instruments



LOUTE
OSI180467
 Wire tightener, 1,0 mm diam
 22 cm

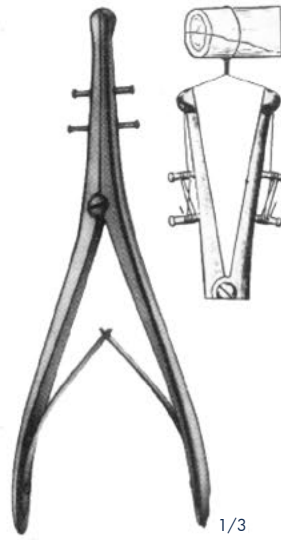

DEMEL
OSI180468
 27 cm



Screw and Plate Instruments

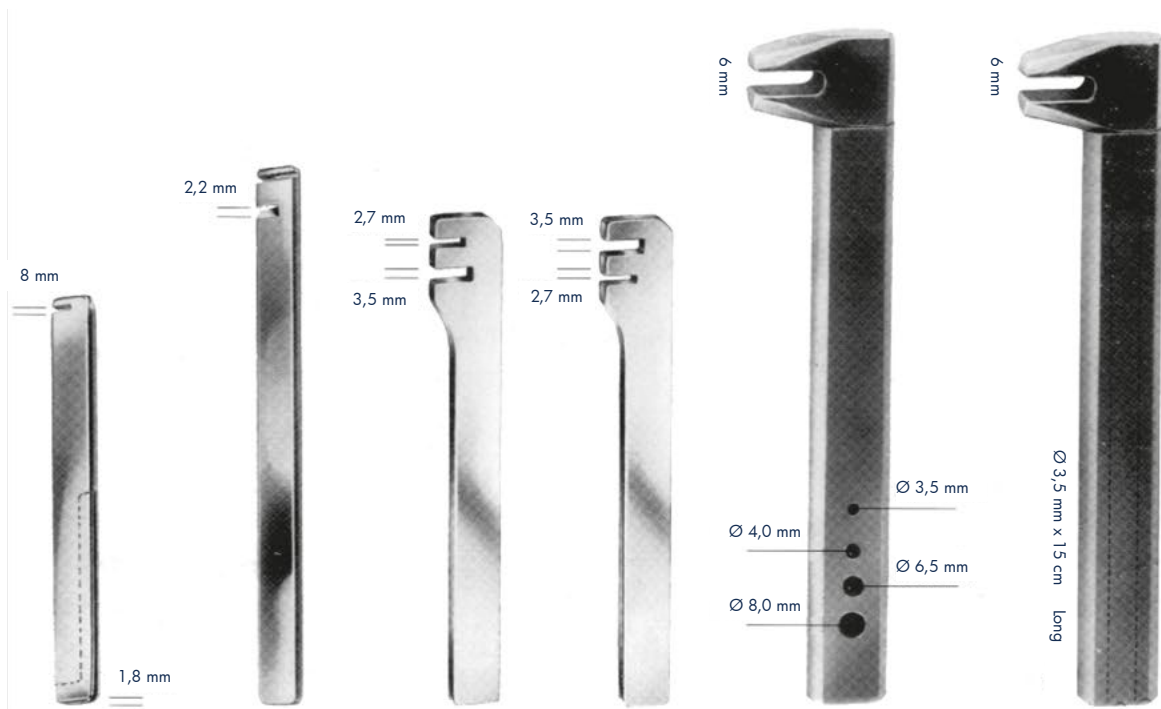

OSI210773
Bending iron
12 cm

OSI210774
Bending iron
16 cm

OSI210775
Bending iron
14 cm

OSI210776
Bending iron
14 cm

JEWETT
OSI210777
Bending iron
20 cm

JEWETT
OSI210778
Bending iron
20 cm

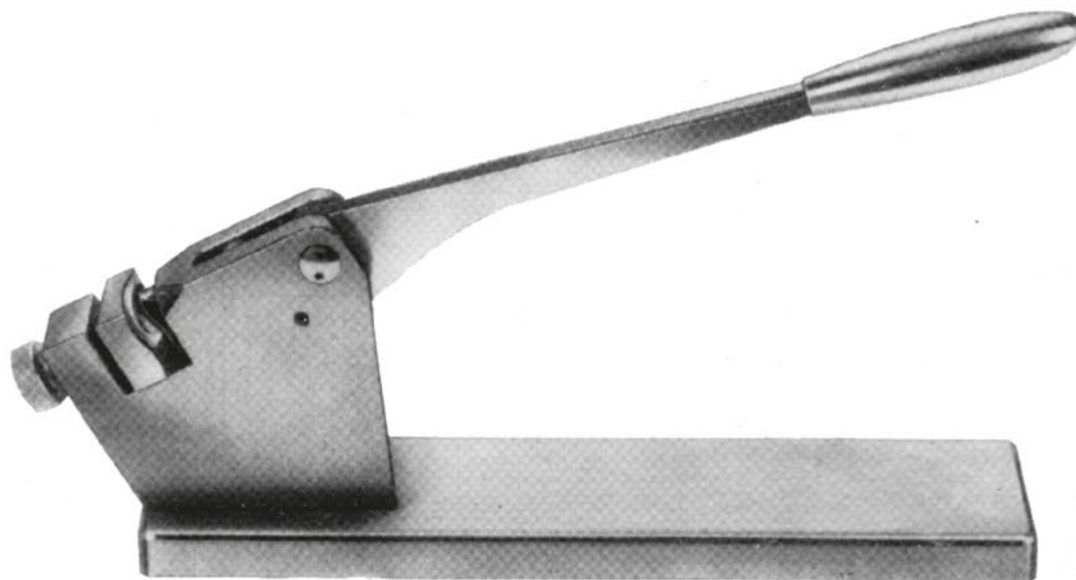

OSI210779
Plate bending and contouring device

TUBB
OSI180
230 mm
Set, const
45°
Ø 4,5 mm

Drill Guides



OSI210780
Handle



OSI210781
Handle



OSI210782
Handle



OSI210783
Ø 0,2 mm



OSI210784
Ø 0,2 mm



OSI210785
Ø 2,5 mm



OSI210786
Ø 2,5 mm



OSI210787
Ø 3,2 mm



OSI210788
Ø 3,2 mm



OSI210789
Ø 3,2 mm



OSI210790
Ø 3,2 mm

Drill Guides



OSI210791
Mini drill guide
Ø 1,5 mm



OSI210792 Ø 2,0 mm
OSI210793 Ø 2,5 mm



OSI210794
Ø 3,2 mm



OSI210795
Drill guide
Ø 3,2 mm



OSI210796
Drill guide
Ø 3,2 mm



OSI210797
Ø 6,5 mm

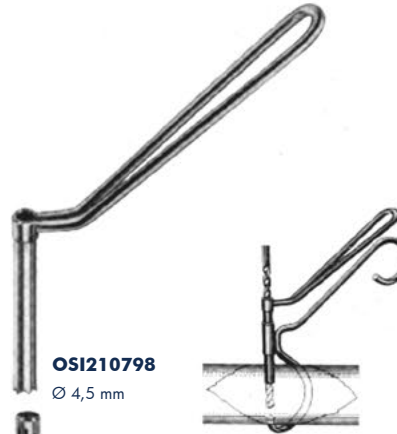

OSI210798
Ø 4,5 mm

OSI210799
Ø 8,0 mm

Tissue protector

OSI210800
Complete



OSI210801 Tissue protector
Ø 6,5 mm



OSI210802
Ø 3,5 mm

Sliding Drill Sleeve



OSI210803
Drill Guide
OSI210806 - OSI210807



OSI210804
Ø 4,5 mm
OSI210808
Drill Guide



OSI210805
Ø 3,5 mm
OSI210806 - OSI210807
Drill guide



	Outside diam	For drills diam	Fitting drill guide
OSI210806	Ø 3,5 mm	Ø 2,0 mm	OSI210803 OSI210805
OSI210807	Ø 3,5 mm	Ø 2,7 mm	OSI210803 OSI210805
OSI210808	Ø 4,5 mm	Ø 3,2 mm	OSI210804



OSI210809

OSI210810
Complete

Sliding Drill Sleeve

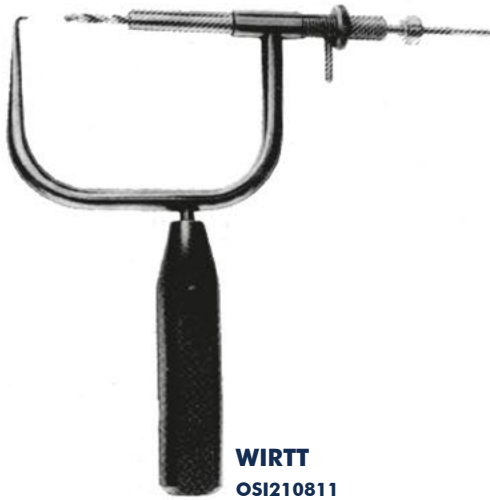

WIRTT
OSI210811
Complete

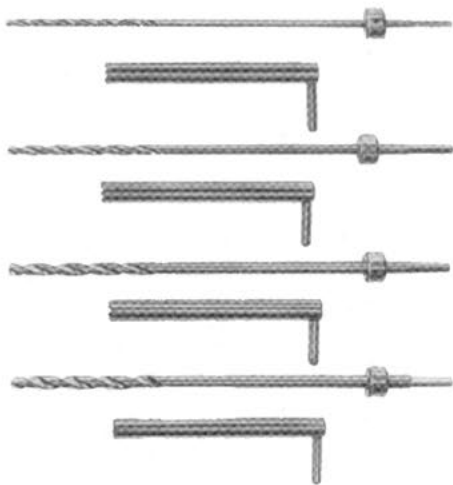

OSI210812
Ø 3 mm Drill and guide

OSI210813
Ø 4 mm Drill and guide

OSI210814
Ø 5 mm Drill and guide

OSI210815
Ø 6 mm Drill and guide

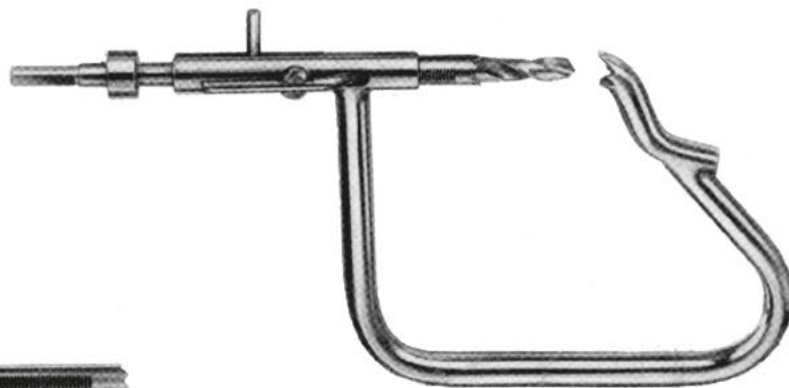

OSI210816
Ø 2,5 mm drill and guide

SCHMDT-RAMSIN
OSI210817 Complete
OSI210818 Body
OSI210819 Ø 7 mm Drill and guide

Instruments for hip Fixation

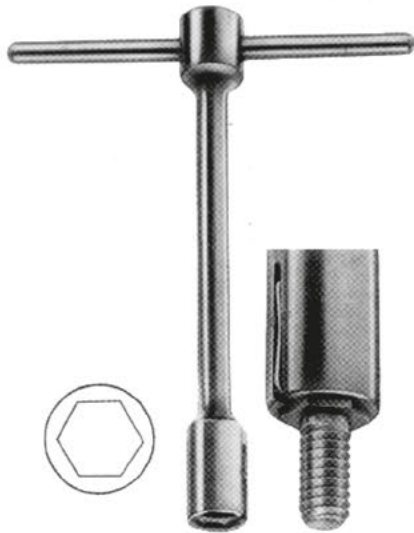

OSI210820 9,5 mm
OSI210821 11,0 mm
OSI210822 13,0 mm
 13 cm T^WWrench



OSI210823
 13 cm



TRIFFIN
OSI210824
 17 cm

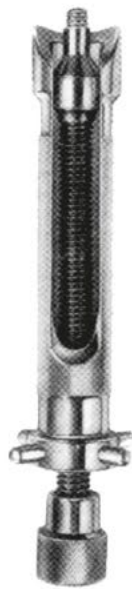

JEWETT
OSI210825
 Impactor/Extractor
 20 cm

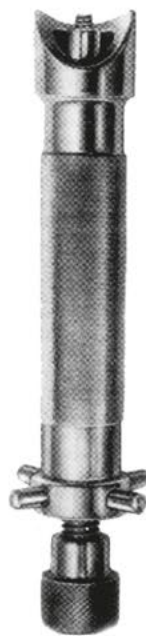

SMITH-PETERSON
OSI210826
 Impactor/Extractor
 20 cm



OSI210827
 Impactor
 20 cm



OSI210828
 Impactor/Extractor
 24 cm

Instruments For Hip Fixation



OSI210829
14 cm



OSI210830
18 cm



OSI210831
23 cm



OSI210832
27 cm



OSI210833
25 cm



OSI210834
30 cm



OSI210835
28 cm



OSI210836
10 cm



OSI210837
10 cm

Instruments For Angular Nail Plates



OSI210838 Impactor
26 cm



OSI210839 Impactor
26 cm



OSI210840 Impactor/Extractor
26 cm



OSI210841 Impactor
28 cm

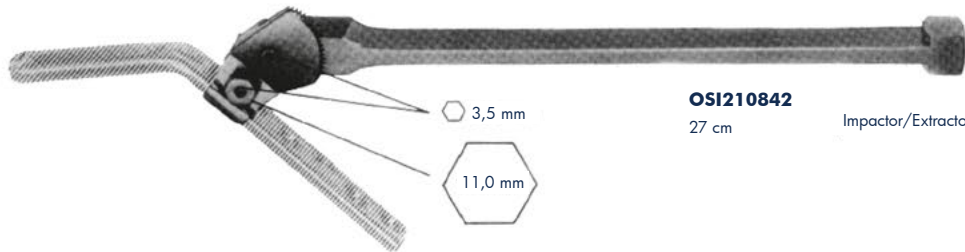

OSI210842 Impactor/Extractor
27 cm



OSI210843 Inserter
26 cm



OSI210844 Impactor/Extractor
26 cm



OSI210845 Impactor
28,5 cm

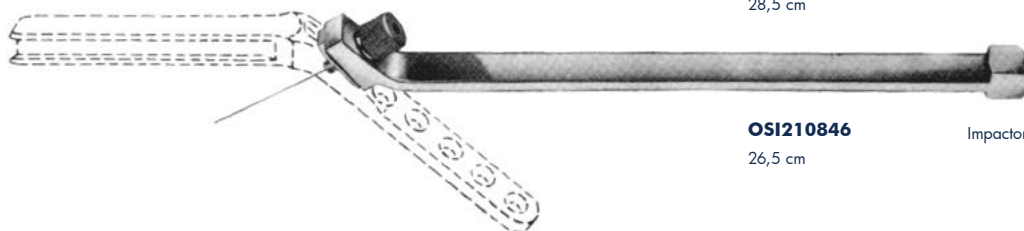

OSI210846 Impactor
26,5 cm

Instruments For Angular Nail Plates



OSI210853 130°
Drill guide

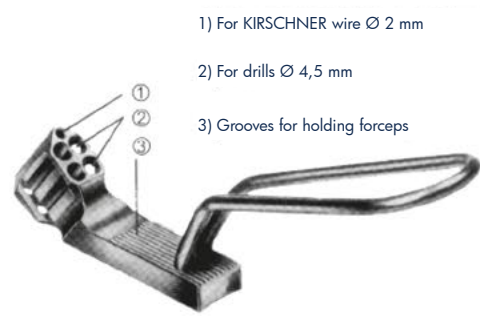

OSI210854 130°
Drill guide

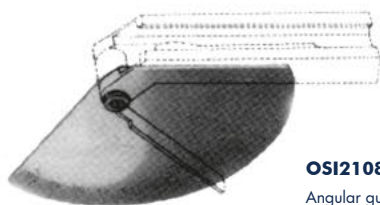

OSI210855
Angular guide for chisel guide



3,5 mm

OSI210856
Sliding guide

Instruments For Removing Broken Screws



OSI210857 3,5 mm **OSI210860** 3,5 mm **OSI210863** 3,5 mm **OSI210866** 3,5 mm **OSI210869** 9 mm
OSI210858 4,5 mm **OSI210861** 4,5 mm **OSI210864** 4,5 mm **OSI210867** 4,5 mm 22 cm
OSI210859 6,5 mm **OSI210862** 6,5 mm **OSI210865** 6,5 mm **OSI210868** 6,5 mm



OSI210870
 20 cm



OSI210871 Ø 2,5 mm
OSI210872 Ø 3,2 mm
 14 cm



OSI210873 Ø 5 mm
 14 cm

Staples Set



BLOUNT
OSI210874
Inserter
19 cm



BLOUNT
OSI210875
Extractors
19 cm



BLOUNT
OSI210876
Extractors
18,5 cm



OSI210877
Extractors
20 cm

Ender Instruments



OSI210878
Extractor
40 cm



OSI210879
Impactor
20 cm



OSI210880
Holder
20 cm



OSI210881
Mallet
19 cm



OSI210882
Ø 5 mm
20 cm



OSI210883
Ø 7 mm
20 cm

Kuntscher Instruments



OSI210884
Dura protector
10 cm



1/2
OSI210885
13 mm
Impactor
19 cm



1/2
OSI210886 Ø 21 mm
OSI210887 Ø 17 mm
Impactor
20 cm



KUNTSCHER
OSI210888
OSI210889
Reamer
26 cm



KUNTSCHER
OSI210890
Reamer
36 cm

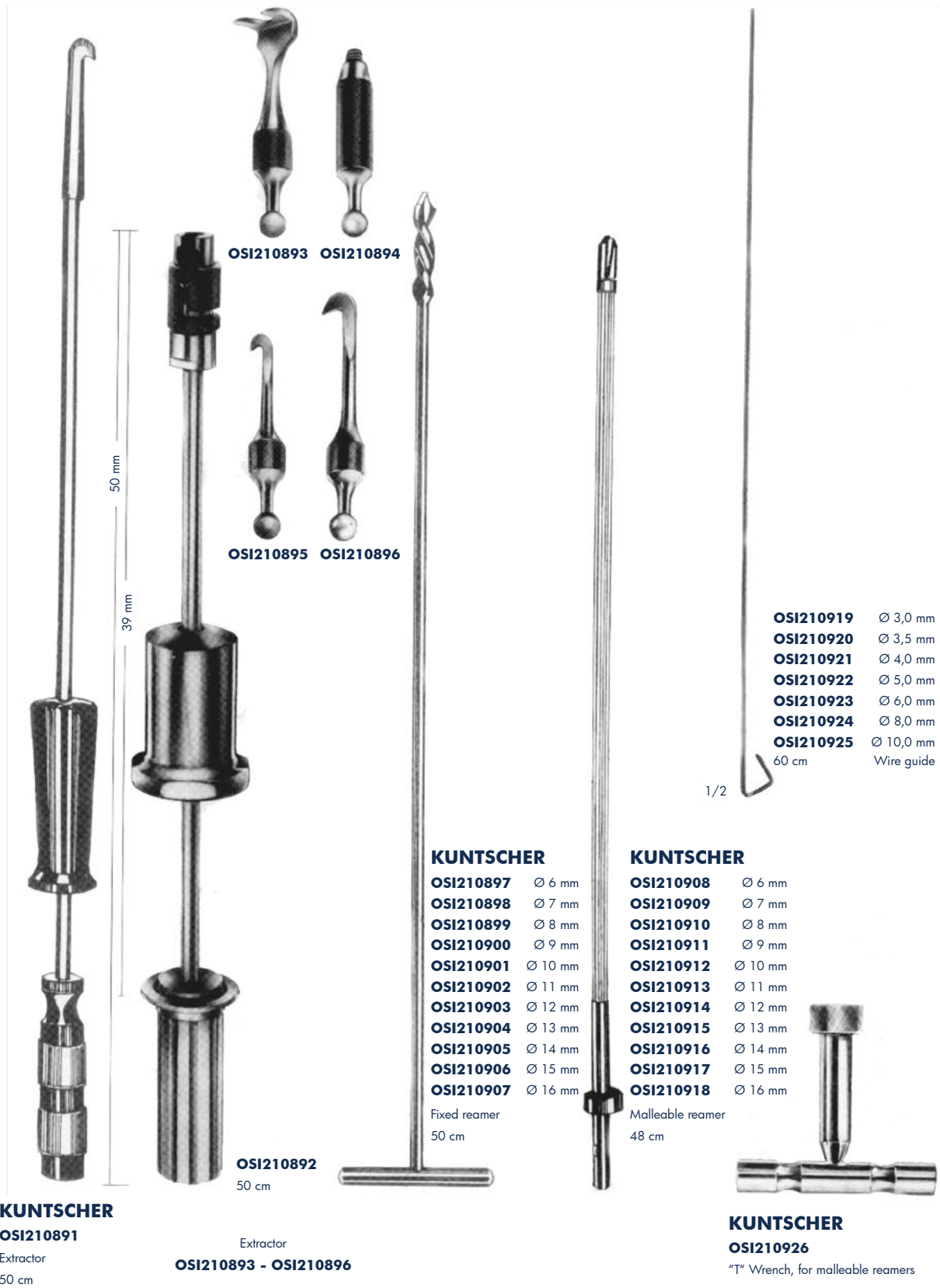

Protheses Instruments

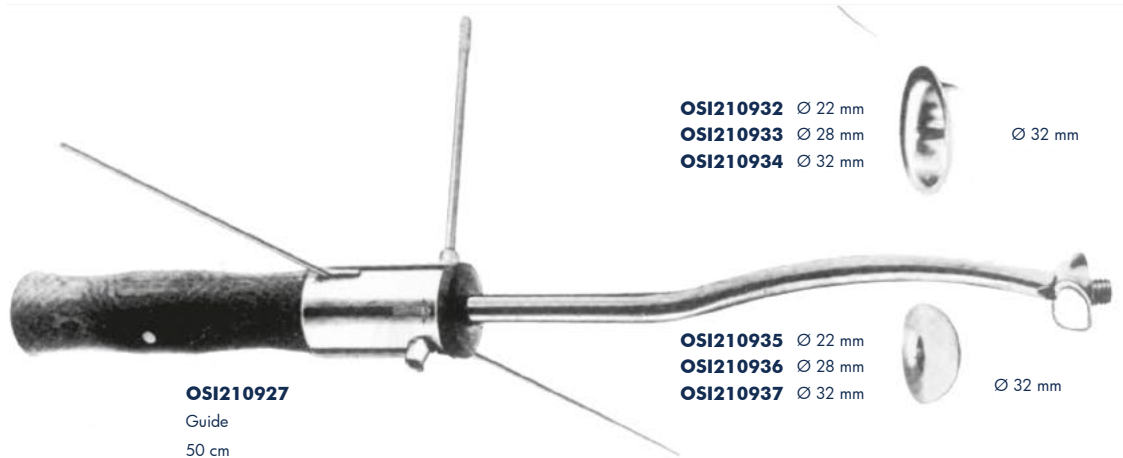

OSI210928
Pusher
25 cm



OSI210929
Pusher
14 cm

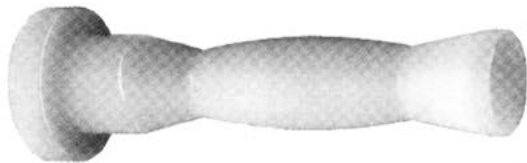

OSI210930
Pusher
14 cm

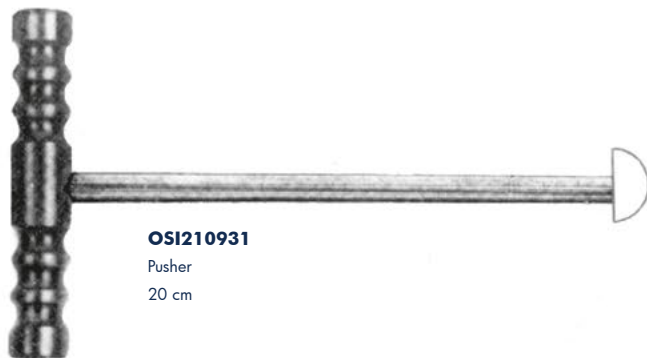

OSI210931
Pusher
20 cm

Protheses Instruments



AUSTIN
OSI210938
21 cm



OSI210939
Extractor
25 cm

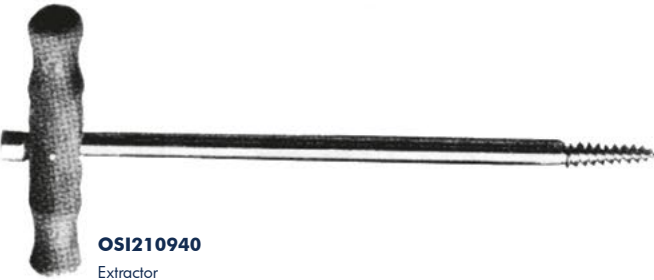

OSI210940
Extractor
27 cm



OSI210941
MORE Protheses Extractor
50 cm



OSI210942
Hip retractor



OSI210943
Weight with chain

Protheses Instruments



OSI210944
"T" Guide handle
21 cm

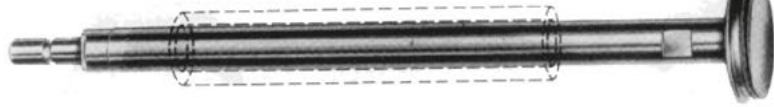

OSI210945
23 cm

- OSI210946** 36 cm
- OSI210947** 38 cm
- OSI210948** 40 cm
- OSI210949** 42 cm
- OSI210950** 44 cm
- OSI210951** 46 cm
- OSI210952** 48 cm
- OSI210953** 50 cm
- OSI210954** 52 cm
- OSI210955** 54 cm
- OSI210956** 56 cm
- OSI210957** 58 cm
- OSI210958** 60 cm
- OSI210959** 62 cm



Acetabulum reamer



TOMPSON
OSI210960
28 cm



MORE
OSI210961
32 cm



OSI210962 7,5 cm
OSI210963 10,0 cm
OSI210964 12,5 cm
OSI210965 15,0 cm
OSI210966 17,5 cm
OSI210967 20,0 cm
30 cm



OSI210968 7,5 cm
OSI210969 10,0 cm
OSI210970 12,5 cm
OSI210971 15,0 cm
OSI210972 17,5 cm
OSI210973 20,0 cm
Straight stemp rasp.
30 cm



OSI210974
30 cm



OSI210975
34 cm



OSI210976
34 cm



OSI210977
41 cm

Protheses Instruments

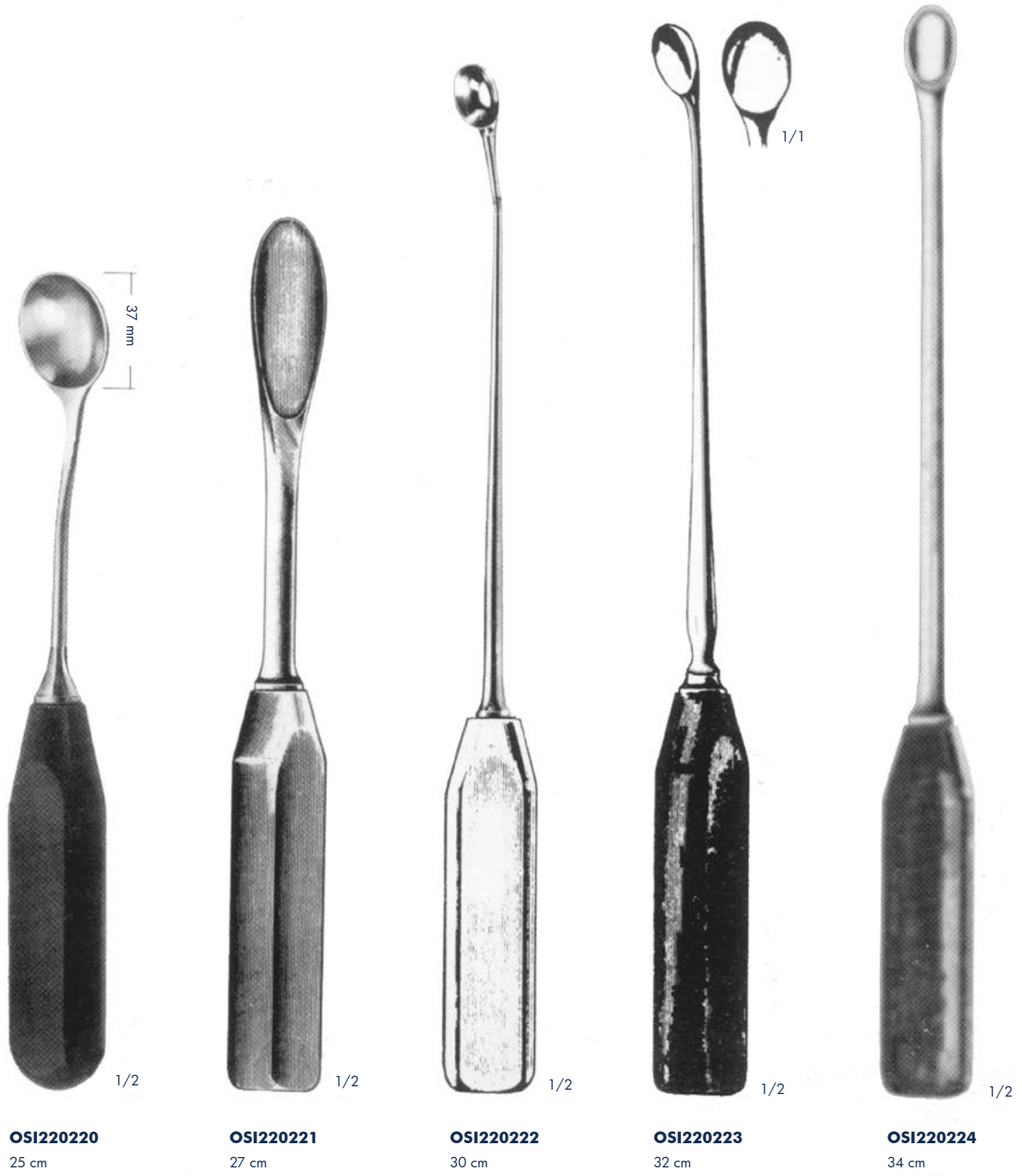

Protheses Instruments

TUBB
OSI180
 230 mm
 Set, consi
 45°
 Ø 4,5 mm

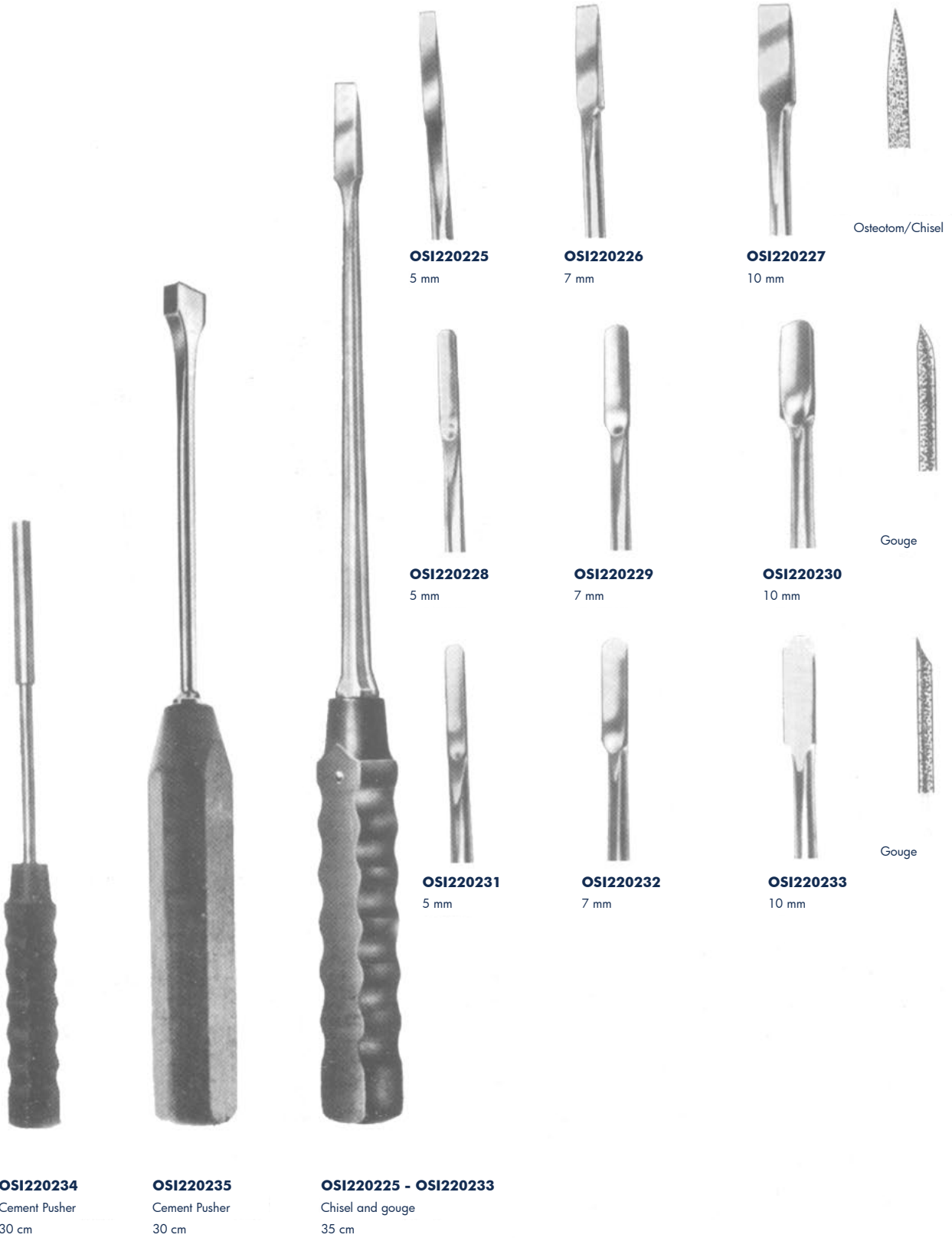

OSI220225
5 mm

OSI220226
7 mm

OSI220227
10 mm

Osteotom/Chisel

OSI220228
5 mm

OSI220229
7 mm

OSI220230
10 mm

Gouge

OSI220231
5 mm

OSI220232
7 mm

OSI220233
10 mm

Gouge

OSI220234
Cement Pusher
30 cm

OSI220235
Cement Pusher
30 cm

OSI220225 - OSI220233
Chisel and gouge
35 cm

Hand Surgery

S
285

isting of:

m



OSI220236 Chisel size

OSI220237 Adult size

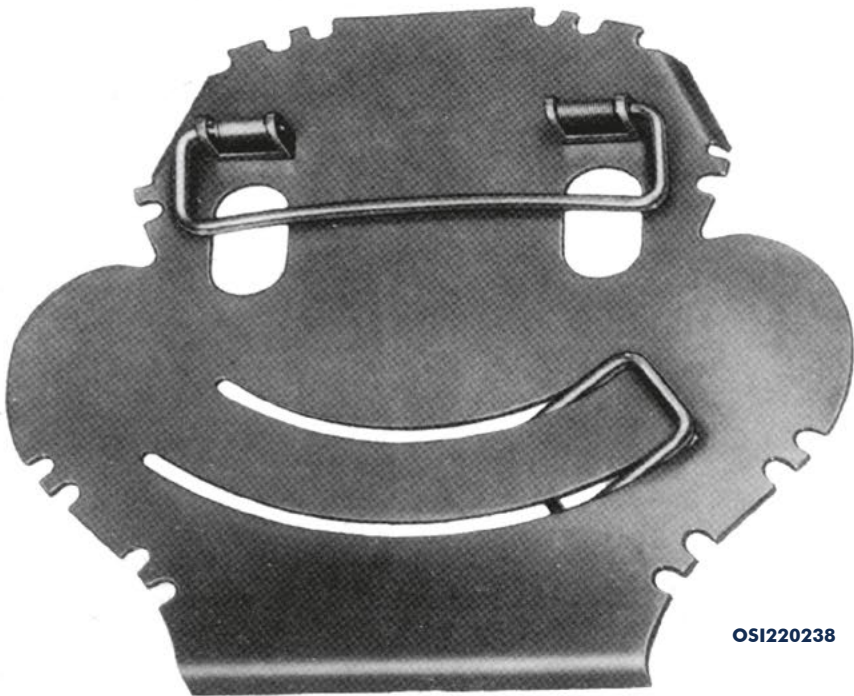

OSI220238

Hand Surgery

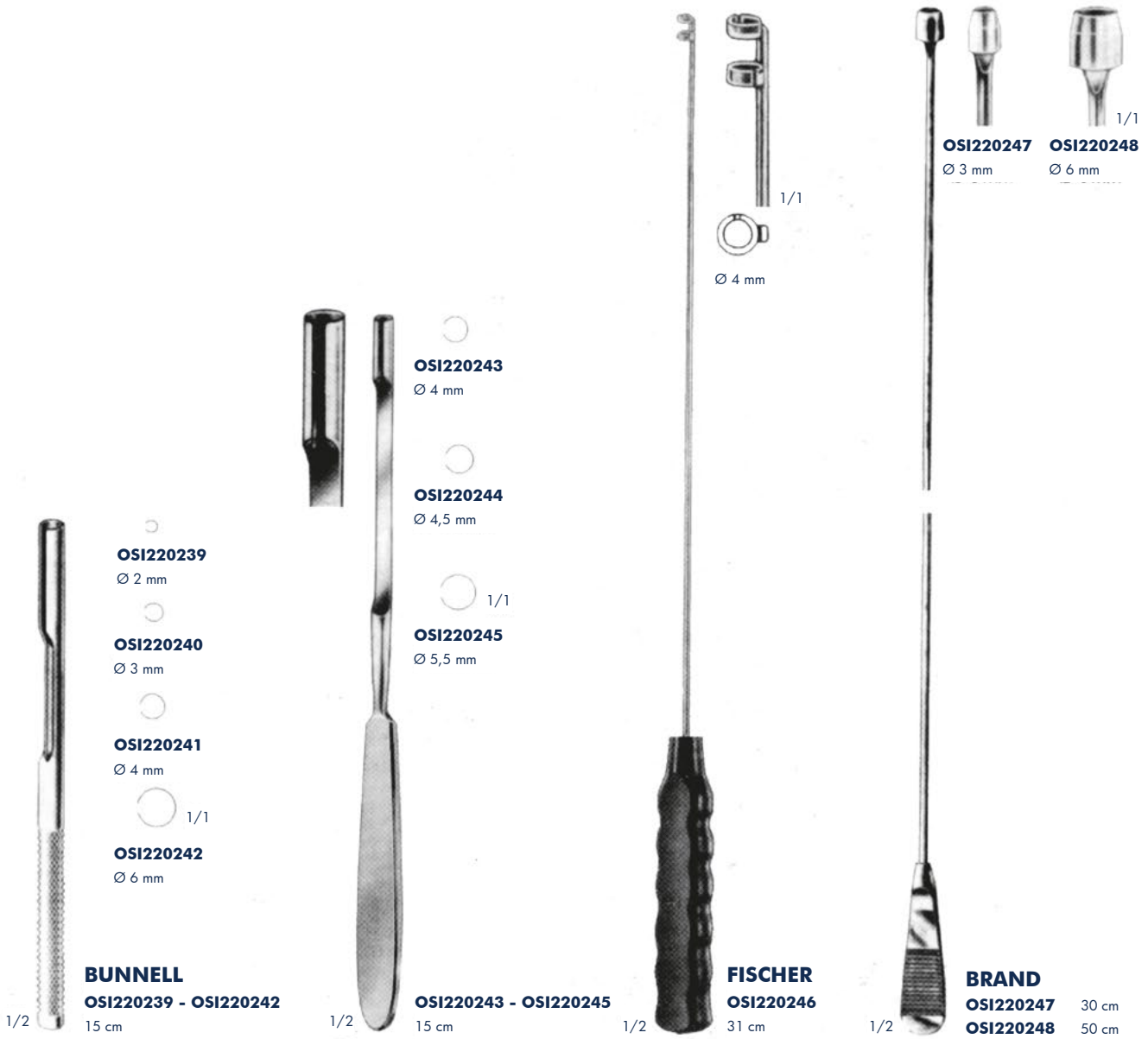

Ear Forceps

OSI220282 - OSI250294

Aural forceps for examination. Opening and closing of the jaw by means of thumb ring-handle

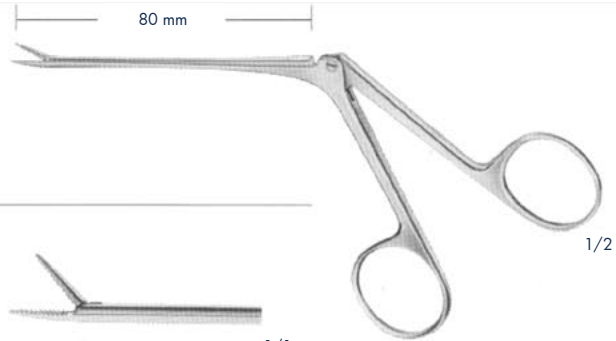

1/2

HARTMANN

OSI250282 1 x 8 mm

Ear forceps, serrated jaws, straight



1/1

HARTMANN

OSI250285 2 x 6 mm

Ear forceps, straight, 1 x 2 teeth



1/1

HARTMANN

OSI250291 Ø 2 mm

Ear forceps, straight



1/1

HARTMANN

OSI250290 2 x 7 mm

Ear forceps, oval, straight



1/1

HARTMANN

OSI250292 Ø 2,5 mm

Ear forceps, straight



1/1

HARTMANN

OSI250293 Ø 3 mm

Ear forceps, straight

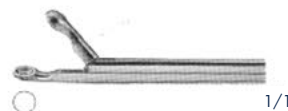

1/1

HARTMANN-CITELLI

OSI250294 Ø 2 mm

Ear forceps, angled up, cup



1/1

Micro Surgery

BUCK

	Outside - Ø
OSI250329 Fig. 00	1,5 mm
OSI250330 Fig. 0	2,0 mm
OSI250331 Fig. 1	2,5 mm
OSI250332 Fig. 2	3,0 mm
OSI250333 Fig. 3	4,0 mm

Ear curettes, curved, sharp
150 mm

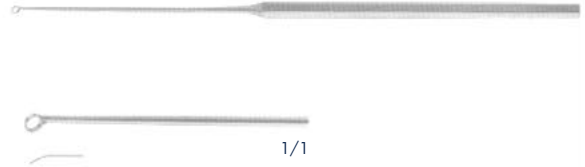

BUCK

	Outside - Ø
OSI250322 Fig. 00	1,5 mm
OSI250323 Fig. 0	2,0 mm
OSI250324 Fig. 1	2,5 mm
OSI250325 Fig. 2	3,0 mm
OSI250326 Fig. 3	4,0 mm

Ear curettes, curved, blunt
150 mm



Ø 1,5 mm

Ø 2,0 mm

Ø 2,5 mm

Ø 3,0 mm

Ø 4,0 mm



QUIRE

OSI250279

Ear forceps for removal of foreign bodies
90 mm

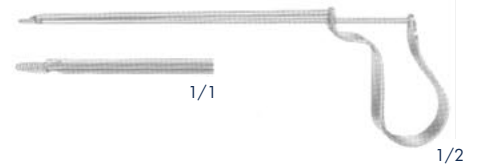

BUCK

OSI250278

Ear forceps alligator type serrated jaws for removal of foreign bodies
90 mm

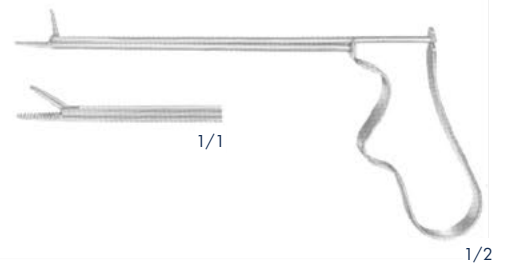

Monopolar HF-Dissecting Forceps

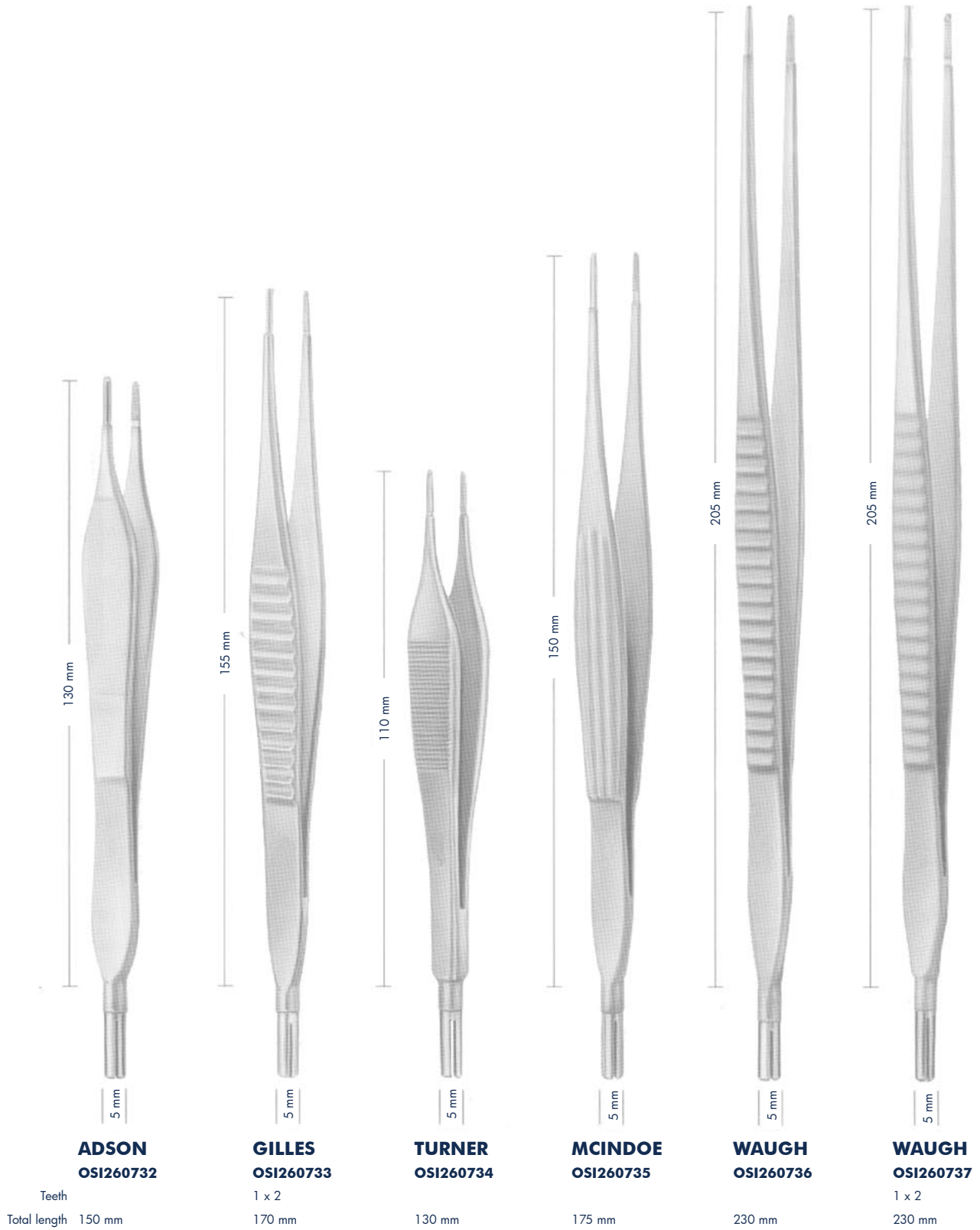

ortimplant

www.ortimplant.com

Ortimplant Samsun
Kirazlık Mahallesi, 1034. Cadde No:14 Tekkek y
SAMSUN / TURKEY
info@ortimplant.com

Workshop
Organize Sanayi Sitesi M.Erdođan Cebeci
Bulvarı No:34 Tekkek y / SAMSUN / TURKEY

Tel : +90 362 266 97 28
Fax : +90 362 266 58 72
info@ortimplant.com

“
Quality
in
Health”